

SwirlMaster FSS400, VortexMaster FSV400

Swirl and Vortex flowmeter



Device firmware version:

- 07.01.xx (HART)
- 01.00.xx (Ethernet-APL)
- 02.02.xx (Modbus RTU)
- 01.00.xx (PROFIBUS)
- 01.00.xx (FOUNDATION Fieldbus)

Measurement made easy

SwirlMaster
FSS430 / FSS450

VortexMaster
FSV430 / FSV450

Introduction

The SwirlMaster FSS4x0 swirl flowmeters combine the measuring dynamics of turbine flowmeters with the robustness and reliability of Vortex flowmeters and require only very short inlet and outlet sections.

The robust VortexMaster FSV4x0 vortex flowmeter by ABB is a high-performance and reliable tool, which is especially suited for the measurement of liquids, gas, and steam.

Equipped with digital signal processing (DSP) and advanced filtering techniques, these innovative flowmeters allow for excellent flow signal detection and provide measurement immunity from the effects of hydraulic noise and pipe vibration.

Additional Information

Additional documentation on SwirlMaster FSS400, VortexMaster FSV400 is available for download free of charge at www.abb.com/flow.

Alternatively simply scan this code:



FSS430

FSS450

FSV430

FSV450

Table of contents

1 Safety	5	4 Product identification	33
General information and instructions	5	Name plate	33
Warnings	5	5 Transport and storage	34
Intended use.....	5	Inspection.....	34
Improper use	5	Transport.....	34
Warranty provisions.....	6	Storing the device.....	34
Cyber security disclaimer.....	6	Ambient conditions.....	34
Software downloads.....	6	Returning devices	34
Manufacturer's address	6	6 Installation	35
Service address	6	Safety instructions	35
2 Use in potentially explosive atmospheres	7	Installation conditions	35
Obligations of the operator.....	7	General	35
Ex marking	7	Inlet and outlet sections.....	36
ATEX, IECEx, NEPSI.....	7	Avoiding cavitation	37
FM / CSA.....	7	Installation at high measuring	
Overview of explosion protection approvals	8	medium temperatures.....	37
Assembly and operating instructions.....	9	Installation for external pressure and	
Devices with aluminum housing	9	temperature measurement.....	37
Protection against electrostatic discharges	9	Installation of setting equipment.....	37
Opening and closing the housing.....	9	Flowmeter sensor insulation recommendation	38
Temperature resistance for the connecting cable.....	9	Ambient conditions	38
Cable glands	10	Ambient temperature.....	38
Signal cable installation in accordance with cFmus	10	Relative humidity.....	38
Electrical connections	11	Measuring medium temperature range.....	38
Electrical connection – 4 to 20 mA / HART® device.....	11	Pressure Equipment Directive.....	39
Electrical connection – Ethernet-APL™	11	Material fatigue in pipe components.....	39
Electrical connection – Modbus-RTU®	12	CRN approval.....	39
Electrical connection – PROFIBUS PA® /		Material load.....	40
FOUNDATION Fieldbus® FISCO-Concept.....	12	Installing the sensor	41
Type of protection ‘non-sparking’ (Ex ec) and		Installation of the flowmeter	41
‘intrinsic safety’ (Ex ic), Zone 2, 22	13	Centering the wafer type design	42
Ex marking	13	Opening and closing the housing	42
Electrical Data.....	14	Adjusting the transmitter position.....	43
Temperature Data	15	7 Electrical connections	44
Zone 0, 1, 20, 21 - type of protection ‘intrinsically safe’ ..	17	Safety instructions	44
Ex marking	17	Installing the connection cables.....	45
Electric and temperature data	18	Cable glands.....	45
Limit value tables	20	Grounding.....	45
Type of protection ‘flameproof (enclosure)’ –		Connecting inputs, outputs and digital	
Zone 1, 21	25	communication.....	46
Ex marking	25	Connection to remote mount design	46
Electric and temperature data	25	Cable specification.....	46
Repair.....	26	Recommended cables.....	46
3 Design and function	27	Installing the signal cable.....	47
Overview	27	Producing a signal cable.....	47
SwirlMaster FSS430 / FSS450.....	27	Connecting the signal cable.....	48
VortexMaster FSV430 / FSV450	28		
Transmitter.....	29		
Model variants.....	30		
Measurement principle.....	30		
Available LCD indicator variants.....	32		

8	Digital communication.....	49	10	Operation.....	87
	Digital output – Electrical data	49		Safety instructions	87
	Devices with HART® communication	49		Account and password.....	87
	Current output / HART output.....	49		Parameterization of the device	87
	Current output / HART output, digital output and			Menu navigation.....	87
	analog input.....	49		Menu navigation – SmartHMI.....	88
	Current output / HART output.....	50		Menu levels	91
	Analog input 4 to 20 mA	51		Process display	92
	HART® communication with remote transmitter.....	51		Switching to the information level	
	Eliminating HART® communication faults.....	53		(operator menu).....	92
	Devices with Ethernet-APL™ communication.....	55		Switching to the configuration level	
	Terminal layout.....	55		(parameterization)	93
	Ethernet-APL™ network topology.....	56		Selecting and changing parameters.....	94
	Devices with Modbus RTU® communication.....	57		Entry from table	94
	Devices with PROFIBUS PA® or			Numerical entry	94
	FOUNDATION-Fieldbus® communication	59		Alphanumeric entry.....	94
	Power supply.....	59		Error messages on the LCD display	95
	Cable specification.....	59		Parameter overview.....	96
	PROFIBUS PA®.....	60		Parameter descriptions	106
	FOUNDATION Fieldbus®	61		Menu: Easy Setup	106
9	Commissioning.....	63		Menu: Device Info	110
	Safety instructions	63		Menu: Device Setup.....	112
	General.....	63		Menu: Display.....	116
	General commissioning.....	63		Menu: Input/Output.....	117
	Commissioning of devices with HART®, Modbus RTU®			Menu: Process Alarm.....	120
	and Ethernet-APL communication.....	63		Menu: Communication for devices with	
	Hardware settings.....	63		HART® communication.....	121
	Digital output	63		Menu: Communication for devices with	
	Devices with HART® communication.....	64		Ethernet-APL communication.....	122
	Devices with Ethernet-APL™ communication.....	66		Menu: Communication for devices with	
	DIP switch on the FSx430 / FSX450 Ethernet-APL			Modbus® communication.....	124
	communication board	66		Menu: Communication for devices with	
	Devices with Modbus RTU® communication.....	67		PROFIBUS PA® communication.....	125
	DIP switch on the FSx430 / FSX450 Modbus			Menu: Communication for devices with	
	communication board	67		FOUNDATION Fieldbus® communication	127
	Devices with PROFIBUS PA® or			Menu: Diagnostics.....	129
	FOUNDATION-Fieldbus® communication	68		Menu: Totalizer	131
	DIP switch on the PROFIBUS PA®- /			Counter overflow.....	132
	FOUNDATION Fieldbus® communication board.....	68		Software history	132
	Checks prior to commissioning.....	69		Zero point balance under operating conditions.....	134
	Power Supply Power-Up.....	69		Automatic zero point balancing	134
	Checks after switching on the power supply	69		Manual zero point balancing.....	134
	Parameterization of the device	70		Advanced filter	135
	Factory settings	70		Noise suppression	135
	Installation of the ABB Field Information Manager				
	(FIM).....	70			
	Parameterization via HART®.....	71			
	Parameterization via My Device Manager mobile app.....	72			
	Parameterization via the menu function Easy Setup	74			
	Open the Menu Easy Setup.....	74			
	Devices with HART®, Modbus® or Ethernet-APL™				
	communication	78			
	Operating modes	78			
	Energy measurement.....	83			

11	Diagnosis / error messages	136
	General Notes.....	136
	Sensor.....	136
	Application conditions.....	136
	Transmitter.....	136
	Calling up the error description.....	137
	Possible error messages	138
	Errors.....	138
	Function check.....	139
	Operation outside of specifications (out of spec)...	140
	Maintenance	141
	Response of the outputs to error messages.....	142
	Malfunctions without error messages.....	144
12	Maintenance	146
	Safety instructions	146
	Cleaning.....	146
	Sensor	146
13	Repair	147
	Replacing the transmitter, downloading system data..	147
	Returning devices	147
14	Dismounting and disposal	148
	Dismounting.....	148
	Disposal	148
15	Specification	148
16	Additional documents	148
17	Appendix	149
	Return form	149
	Measuring range table.....	150
	FSV430, FSV450.....	150
	FSS430, FSS450.....	151
	vFCC / ISED certification.....	152
	FCC statement.....	152
	ISED (Canada) regulatory information.....	152

1 Safety

General information and instructions

These instructions are an important part of the product and must be retained for future reference.

Installation, commissioning, and maintenance of the product may only be performed by trained specialist personnel who have been authorized by the plant operator accordingly. The specialist personnel must have read and understood the manual and must comply with its instructions.

For additional information or if specific problems occur that are not discussed in these instructions, contact the manufacturer.

The content of these instructions is neither part of nor an amendment to any previous or existing agreement, promise or legal relationship.

Modifications and repairs to the product may only be performed if expressly permitted by these instructions.

Information and symbols on the product must be observed.

These may not be removed and must be fully legible at all times.

The operating company must strictly observe the applicable national regulations relating to the installation, function testing, repair and maintenance of electrical products.

Warnings

The warnings in these instructions are structured as follows:

DANGER

The signal word '**DANGER**' indicates an imminent danger. Failure to observe this information will result in death or severe injury.

WARNING

The signal word '**WARNING**' indicates an imminent danger. Failure to observe this information may result in death or severe injury.

CAUTION

The signal word '**CAUTION**' indicates an imminent danger. Failure to observe this information may result in minor or moderate injury.

NOTICE

The signal word '**NOTICE**' indicates possible material damage.

Note

'**Note**' indicates useful or important information about the product.

Intended use

This device is intended for the following uses:

- For conveying liquid and gaseous media (including unstable liquids and gases)
- For measuring volume flow in the operating condition.
- For measuring standard volume flow (indirectly via volume flow rate, pressure and temperature).
- For measuring mass flow (indirectly via volume flow, pressure / temperature and density)
- For measuring the energy flow (indirectly via volume flow, pressure / temperature and density)
- For measuring the temperature of the medium

The device has been designed for use exclusively within the technical limit values indicated on the identification plate and in the data sheets.

When using measuring media, the following points must be observed:

- Measuring media may only be used if, based on the state of the art or the operating experience of the user, it can be assured that the chemical and physical properties necessary for operational security of the materials of the wetted parts of the flowmeter sensor will not be adversely affected during the operating time.
- Media containing chloride in particular can cause corrosion damage to stainless steels which, although not visible externally, can damage wetted parts beyond repair and lead to the measuring medium escaping. It is the operator's responsibility to check the suitability of these materials for the respective application.
- Measuring media with unknown properties or abrasive measuring media may only be used if the operator is able to perform regular and suitable tests to ensure the safe condition of the device

Improper use

The following are considered to be instances of especially improper use of the device:

- Operation as a flexible compensating adapter in piping, for example for compensating pipe offsets, pipe vibrations, pipe expansions, etc.
- For use as a climbing aid, for example for mounting purposes.
- For use as a bracket for external loads, for example as a support for piping, etc.
- Material application, for example by painting over the housing, name plate or welding/soldering on parts.
- Material removal, for example by spot drilling the housing.

... 1 Safety

Warranty provisions

Using the device in a manner that does not fall within the scope of its intended use, disregarding this manual, using underqualified personnel, or making unauthorized alterations releases the manufacturer from liability for any resulting damage. This renders the manufacturer's warranty null and void.

Cyber security disclaimer

This product is designed to be connected to and to communicate information and data via a network interface. It is operator's sole responsibility to provide and continuously ensure a secure connection between the product and your network or any other network (as the case may be). Operator shall establish and maintain any appropriate measures (such as but not limited to the installation of firewalls, application of authentication measures, encryption of data, installation of anti-virus programs, etc.) to protect the product, the network, its system and the interface against any kind of security breaches, unauthorized access, interference, intrusion, leakage and/or theft of data or information. ABB and its affiliates are not liable for damages and/or losses related to such security breaches, any unauthorized access, interference, intrusion, leakage and/or theft of data or information.

On www.abb.com/cybersecurity under 'Additional resources', 'Alerts and notifications' you will find notifications about newly discovered software vulnerabilities. It is recommended that you visit this website regularly and activate 'Subscribe to email alerts' to receive email notifications about 'ABB cyber security alerts and notifications'.

Software downloads

By visiting the web page indicated below, you will find options to download the latest software. It is recommended that you visit this web page regularly:

[ABB Library - Swirl flowmeters - Software Downloads](#)



[ABB Library - Vortex flowmeter - Software Downloads](#)



Manufacturer's address

ABB AG
Measurement & Analytics
Schillerstr. 72
32425 Minden
Germany
Tel: +49 571 830-0
Fax: +49 571 830-1806

ABB Inc.
Measurement & Analytics
125 E. County Line Road
Warminster, PA 18974
USA
Tel: +1 215 674 6000
Fax: +1 215 674 7183

ABB Engineering (Shanghai) Ltd.
Measurement & Analytics
No. 4528, Kangxin Highway, Pudong New District
Shanghai, 201319,
P.R. China
Tel: +86(0) 21 6105 6666
Fax: +86(0) 21 6105 6677
Email: china.instrumentation@cn.abb.com

Service address

Customer service center
Tel: +49 180 5 222 580
Email: automation.service@de.abb.com

2 Use in potentially explosive atmospheres

Obligations of the operator

Ex marking

If the device manufacturer has not specified the type of protection on the name plate, the operator must specify the type of protection used on the name plate, by permanent means, during installation of the device.

ATEX, IECEX, NEPSI

The installation, commissioning, maintenance and repair of devices in potentially explosive atmospheres must only be carried out by appropriately trained personnel. Works may be carried out only by persons, whose training has included instructions on different types of protection and installation techniques, concerned rules and regulations as well as general principles of zoning.

The person must possess the appropriate competences for the type of work to be conducted.

The safety instructions for electrical apparatus in potentially explosive areas must be in accordance with Directive 2014/34/EU (ATEX) and IEC 60079-14 (Installation of electrical equipment in potentially explosive areas).

Comply with the applicable regulations for the protection of employees to ensure safe operation.

FM / CSA

The installation, commissioning, maintenance and repair of devices in areas with explosion hazard must only be carried out by appropriately trained personnel.

The operator must strictly observe the applicable national regulations with regard to installation, function tests, repairs, and maintenance of electrical devices. (e. g. NEC, CEC).

... 2 Use in potentially explosive atmospheres

Overview of explosion protection approvals

The following tables provide an overview of the approvals available for explosion protection.

Refer to the appropriate chapter for information on Ex marking as well as electric and temperature data!

Type of protection 'non-sparking' (Ex ec) and 'intrinsic safety' (Ex ic*), Zone 2, 22

Approval	Order code	Ex relevant specifications
ATEX (Europe)	B1	Refer to Type of protection 'non-sparking' (Ex ec) and 'intrinsic safety' (Ex ic) , Zone 2, 22 on page 13.
IECEX	N1	
NEPSI (China)	S2	
FM (USA and Canada)	F3	

* Only for devices with PROFIBUS PA®, FOUNDATION-Fieldbus® or Ethernet-APL™ communication.

Type of protection 'intrinsic safety' (Ex ia / IS), Zone 0, 1, 20, 21

Approval	Order code	Ex relevant specifications
ATEX (Europe)	A4	Refer to Zone 0, 1, 20, 21 - type of protection 'intrinsically safe' on page 17.
IECEX	N2	
NEPSI (China)	S6	
FM (USA and Canada)	F4	

Type of protection 'flameproof enclosure' (Ex db ia / XP-IS), Zone 1, 21

Approval	Order code	Ex relevant specifications
ATEX (Europe)	A9	Refer to Type of protection 'flameproof (enclosure)' – Zone 1, 21 on page 25.
IECEX	N3	
NEPSI (China)	S1	
FM (USA and Canada)	F1	

Combined approvals

In the case of combined approvals, the user decides on the type of protection during installation.

Type of protection	Order code	Ex relevant specifications
ATEX Ex ec + Ex ia	B8 = B1 + A4	For combined approvals, the Ex relevant specification of the respective individual approvals apply.
ATEX Ex ec + Ex ia + Ex db ia	B9** = B1 + A4 + A9	
IECEX Ex ec + Ex ia	N8 = N1 + N2	
IECEX Ex ec + Ex ia + Ex db ia	N9** = N1 + N2 + N3	
NEPSI Ex ec + Ex ia	S8 = S2 + S6	
NEPSI Ex ec + Ex ia + Ex db ia	S9** = S2 + S1 + S6	
cFMus NA + IS	F8 = F3 + F4	
cFMus NA + IS + XP-IS	F9** = F3 + F4 + F1	

** Combined approvals B9, N9, S9 and F9 are only available with signal output Profibus PA (model code P1) or FOUNDATION Fieldbus (model code F1)

Assembly and operating instructions

Devices with aluminum housing

DANGER

Risk of explosion!

Risk of explosion due to formation of sparks.
Devices with housing components made of aluminum can form an ignition source, as sparks occur due to mechanical friction or impact.

- When working on the devices, only use tools that are approved for working with aluminum in potentially explosive atmospheres.
- Avoid mechanical friction and impacts on aluminum components.

Protection against electrostatic discharges

DANGER

Explosion hazard due to electrostatic charging!

The painted surface of the device can store electrostatic charges.

As a result, the housing can form an ignition source due to electrostatic discharges in the following conditions:

- The device is operated in environments with a relative humidity of $\leq 30\%$.
- The painted surface of the device is thereby relatively free from impurities such as dirt, dust or oil.
- Instructions on avoiding ignition in potentially explosive environments due to electrostatic discharges in accordance with PD CLC/TR 60079-32-1 and IEC TS 60079-32-1 must be complied with!

Instructions on cleaning

The painted surface of the device must be cleaned only using a moist cloth.

Opening and closing the housing

DANGER

Danger of explosion if the device is operated with the transmitter housing or terminal box open!

Before opening the transmitter housing or the terminal box, note the following points:

- Check that a valid fire permit is available.
- Make sure that there is no explosion hazard.
- Before opening the device, switch off the power supply and wait for $t > 2$ minutes.

WARNING

Risk of injury due to live parts!

When the housing is open, contact protection is not provided and EMC protection is limited.

- Before opening the housing, switch off the power supply.

See also **Opening and closing the housing** on page 42.

Only original spare parts must be used to seal the housing.

Note

Spare parts can be ordered from ABB Service.

www.abb.com/contacts

Temperature resistance for the connecting cable

The temperature at the cable entries of the device is dependent on the measuring medium temperature T_{medium} and the ambient temperature T_{amb} .

- For electrical connection of the device, cables suited for temperatures up to 110 °C (230 °F) can be used without restriction.
- For cables suited only for temperatures up to 80 °C (176 °F), the connection of both circuits must be checked in the event of a fault. Otherwise, the restricted temperature ranges listed in the following table shall apply.

T_{amb}	T_{medium} maximum	Maximum cable temperature
-40 to 50 °C (-40 to 122 °F)	272 °C (522 °F)	80 °C (176 °F)
-40 to 40 °C (-40 to 104 °F)	400 °C (752 °F)	
-40 to 67 °C (-40 to 153 °F)	180 °C (356 °F)	

... 2 Use in potentially explosive atmospheres

... Assembly and operating instructions

Cable glands

Note

Devices with a ½ in-NPT thread are generally supplied without cable glands.

The devices are supplied with cable glands certified according to ATEX or IECEx.

The cable glands supplied are approved for use in Zone 1.

Please observe the following points:

- The use of standard cable glands and closures is prohibited.
- The black plugs in the cable glands are intended to provide protection during transport. Any unused cable entries must be sealed securely before commissioning.
- The outside diameter of the connection cable must measure between 6 mm (0.24 in) and 12 mm (0.47 in) to guarantee the required tightness.

Flame-resistant pipe fittings

The electrical connection for the flowmeter is made via the cable gland on the device. Alternatively, the flowmeter can be connected using an approved flame-resistant pipe fitting located directly on the device.

To do this, the existing cable gland must be removed.

When selecting suited flame-resistant pipe fittings, please note the following:

- The requirements set out in EN 50018 section 13.1 and 13.2 must be observed.
- The installation requirements set out in EN 60079-14 must be complied with when selecting pipe fittings.
- The outside diameter of the unshielded connection cable must be between 8.0 mm (0.31 in) and 11.7 mm (0.46 in).

Note

The flame-resistant pipe fitting must be assembled in accordance with the manufacturer's assembly instructions supplied with the pipe fitting.

Signal cable installation in accordance with cFMus

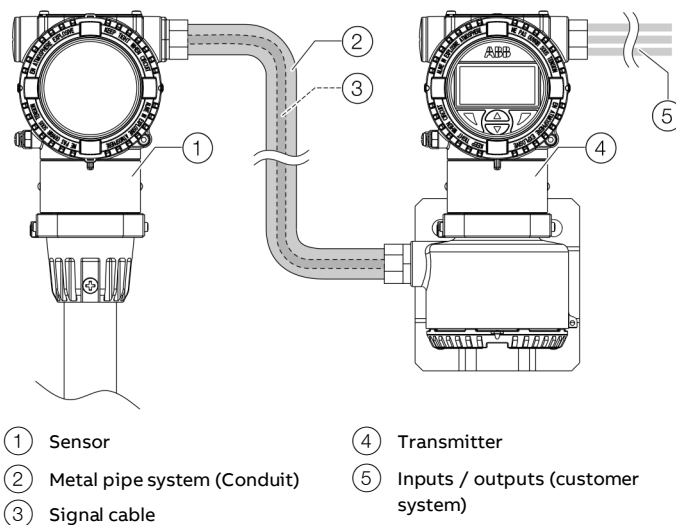

Figure 1: Signal cable installation with FM/CSA

The signal cable must be installed in accordance with the FM16US0227X certificate of conformity and the National Electrical Code, 2017 edition (NFPA70), Article 501.10 (a)(1)(a) wiring methods for Class I, Division 1 in appropriately approved metal pipe systems (Conduits).

They can be stiff metal pipes with threaded screw connections or metal pipes with threads.

Electrical connections

Electrical connection – 4 to 20 mA / HART® device

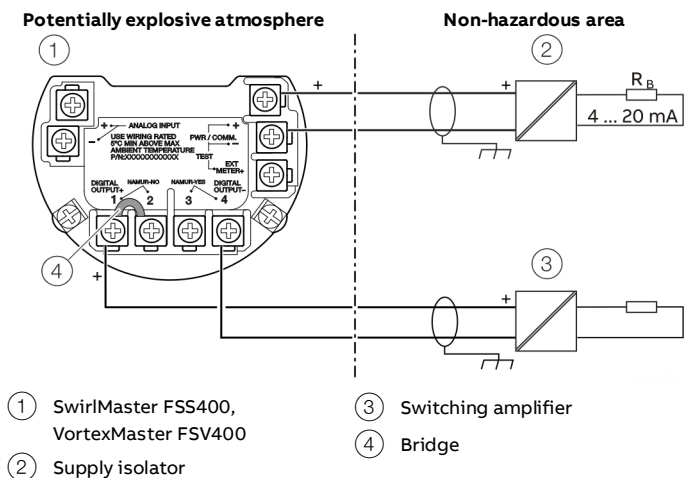

- ① SwirlMaster FSS400, VortexMaster FSV400
- ② Supply isolator
- ③ Switching amplifier
- ④ Bridge

Figure 2: Electrical connection (example)

Output configuration	Bridge
Optoelectronic coupler output	1–2
NAMUR output	3–4

Terminal	Function
PWR/COMM + /	Power supply / current output / HART® output
PWR/COMM -	
DIGITAL OUTPUT+ /	Digital output as optoelectronic coupler or NAMUR output
DIGITAL OUTPUT-	

In the factory setting, the output is configured as an optoelectronic coupler output.

If the digital output is configured as a NAMUR output, a suitable NAMUR switching amplifier must be connected.

HART digital communication and 4 to 20 mA output

See **Devices with HART® communication** on page 49 for details.

Electrical connection – Ethernet-APL™

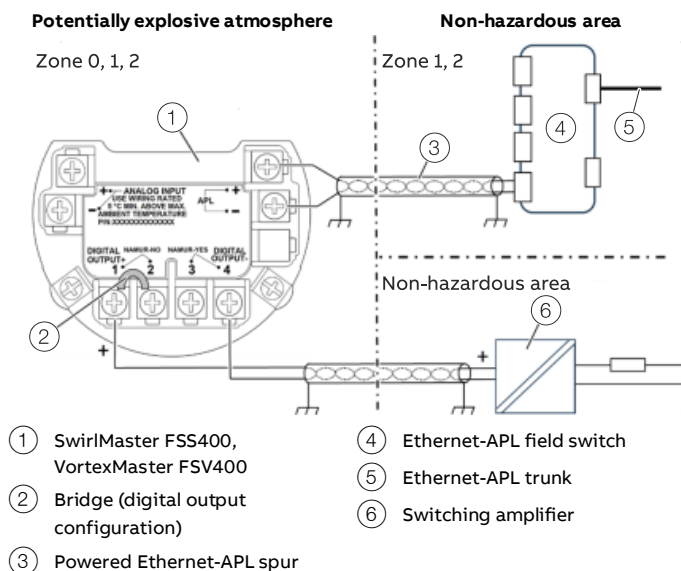

- ① SwirlMaster FSS400, VortexMaster FSV400
- ② Bridge (digital output configuration)
- ③ Powered Ethernet-APL spur
- ④ Ethernet-APL field switch
- ⑤ Ethernet-APL trunk
- ⑥ Switching amplifier

Figure 3: Electrical connection Ethernet-APL (example)

Terminal	Function
APL + / APL -	APL spur power class A load port
DIGITAL OUTPUT+ /	Digital output as optoelectronic coupler or NAMUR output
DIGITAL OUTPUT-	

Output configuration	Bridge
Optoelectronic coupler output	1–2
NAMUR output	3–4

Ethernet-APL is designed to support various installation topologies, with optional redundancy or resiliency concepts and trunk-and-spur.

The trunk provides high power and signal levels for long cable lengths, up to 1000 m (3281 ft).

Whereas, the spur carries lower power with optional intrinsic safety for lengths up to 200 m (656 ft).

Ethernet-APL explicitly specifies point-to-point connections only with each connection between communications partners constituting a segment. Ethernet-APL switches thus isolate communications between segments.

Type of protection ‘non-sparking’ (Ex ec) and ‘intrinsic safety’ (Ex ic), Zone 2, 22

Ex marking

Note

Order code ‘Explosion protection: B9, N9, F9, S9’ is only suitable with order code ‘Output signal: P1 and F1’ – PROFIBUS® and FOUNDATION Fieldbus®.

ATEX / IECEx

ATEX – order code ‘Explosion protection: B1, B8, B9’

Type Examination Test Certificate FM13ATEX0056X

For electrical parameters, see certificate FM13ATEX0056X

Order code ‘Output signal: H1, H5, M4’ – HART®, Modbus RTU®

II 3G Ex ec IIC T4 to T6 Gc

II 3 D Ex tc IIIC T95 °C Dc

Order code ‘Output signal: P1, F1, A1’ – PROFIBUS®, FOUNDATION Fieldbus®, Ethernet-APL

II 3G Ex ic IIC T4...T6 Gc

II 3G Ex ec IIC T4 to T6 Gc

II 3 D Ex tc IIIC T95 °C Dc

FISCO Field Instrument, FF-816

(only with order code ‘Output signal: P1 or F1’ - PROFIBUS®,

FOUNDATION Fieldbus®)

2-WISE Power Load

(only with order code ‘Output signal: A1’ – Ethernet-APL)

IECEx – Order code ‘Explosion protection: N1, N8, N9’

Certificate of conformity IECEx FME 13.0004X

For electrical parameters, see certification IECEx FME 13.0004X

Order code ‘Output signal: H1, H5, M4’ – HART®, Modbus RTU®

Ex ec IIC T4 to T6 Gc

Ex tc IIIC T95 °C Dc

Order code ‘Output signal: P1, F1, A1’ – PROFIBUS®, FOUNDATION Fieldbus®, Ethernet-APL

Ex ic IIC T4...T6 Gc

Ex ec IIC T4 to T6 Gc

Ex tc IIIC T95 °C Dc

FISCO Field Instrument, FF-816

(only with order code ‘Output signal: P1 or F1’ - PROFIBUS®,

FOUNDATION Fieldbus®)

2-WISE Power Load

(only with order code ‘Output signal: A1’ – Ethernet-APL)

FM approval for USA and Canada

FM approval for USA and Canada–

order code ‘Explosion protection: F3, F8, F9’

Housing: TYPE 4X

Order code ‘Output signal: H1, H5, M4’ – HART®, Modbus RTU®

CL I, ZONE 2 AEx/Ex ec IIC T6, T5, T4

CL I/DIV 2/GP ABCD

NI CL 1/DIV 2/GP ABCD,

DIP CL II, III/DIV 2/GP EFG

Order code ‘Output signal: P1, F1, A1’ – PROFIBUS®, FOUNDATION Fieldbus®, Ethernet-APL

CL I, ZONE 2 AEx/Ex ic IIC T6, T5, T4

CL I, ZONE 2 AEx/Ex ec IIC T6, T5, T4

NI CL 1/DIV 2/GP ABCD,

DIP CL II,III/DIV 2/GP EFG

FISCO Field Instrument, FF-816

(only with order code ‘Output signal: P1 or F1’ - PROFIBUS®,

FOUNDATION Fieldbus®)

2-WISE Power Load

(only with order code ‘Output signal: A1’ – Ethernet-APL)

NEPSI (China)

NEPSI – order code ‘Explosion protection: S2, S8, S9’

For electrical parameters, see certificate GYJ24.1066X

Order code ‘Output signal: H1, H5, M4’ – HART®, Modbus RTU®

Ex ec IIC T4 to T6 Gc

Ex tc IIIC T95 °C Dc

Order code ‘Output signal: P1, F1, A1’ – PROFIBUS®, FOUNDATION Fieldbus®, Ethernet-APL

Ex ic IIC T4 to T6 Gc

Ex ec IIC T4 to T6 Gc

Ex tc IIIC T95 °C Dc

FISCO Field Instrument, FF-816

(only with order code ‘Output signal: P1 or F1’ - PROFIBUS®,

FOUNDATION Fieldbus®)

FISCO Field Device, 2-WISE Power Load

(only with order code ‘Output signal: A1’ – Ethernet-APL)

... 2 Use in potentially explosive atmospheres

... Type of protection ‘non-sparking’ (Ex ec) and ‘intrinsic safety’ (Ex ic), Zone 2, 22

Electrical Data

The symbols used in this chapter have the following meaning.

ID code	Description
U_S	Supply voltage of the device (U_{Supply})
U_M	Maximum permissible voltage ($U_{Maximum}$)
R_B	Load resistor

Power supply

- Type of protection ‘Ex ec’: $U_S = 12$ to 42 V DC
- Type of protection ‘Ex ic’ (Fisco): $U_S = 9$ to 17.5 V DC

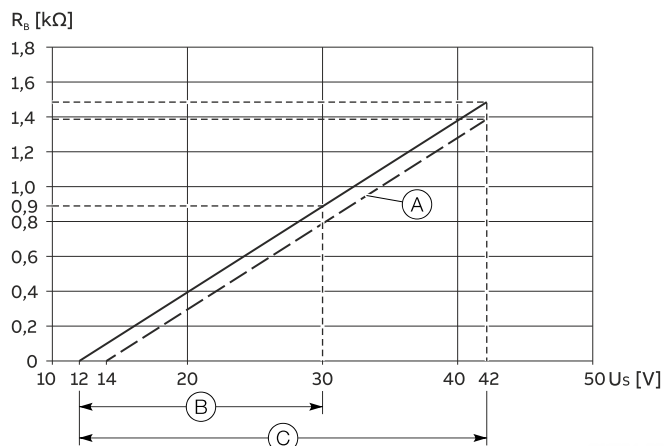

The voltage $U_S = 12$ V is based on a load of 0 Ω .

R_B Maximum permissible load in the power supply circuit, e.g. indicator, recorder or power resistor.

(A) For devices with order code **S1 – surge protection** or **G4 – enhanced EMC protection**

(B) Type of protection Ex ec / NI (Modbus devices)

(C) Type of protection Ex ec / NI (HART devices)

Figure 5: Power supply in Zone 2, explosion protection, non-sparking

Power supply / current output / HART®, Modbus®

HART terminals	PWR/COMM + / PWR/COMM -
Modbus terminals	A (+), B (-) / PWR +, PWR -
U_S	HART: 45 V, Modbus: 30 V
Zone 2:	$T_{amb} = -40$ to xx °C*
Zone 22:	$T_{amb} = -40$ to 75 °C
Housing:	TYPE 4X

* The temperature xx °C depends on the temperature class T_{class}

Power supply / PROFIBUS PA®, FOUNDATION Fieldbus®

Fieldbus terminals	BUS CONNECTION + / BUS CONNECTION -
U_M	45 V DC
Zone 2:	$T_{amb} = -40$ to xx °C* FISCO Field Instrument, FF-816
Zone 22 :	$T_{amb} = -40$ to 75 °C FISCO Field Instrument, FF-816
Housing:	TYPE 4X

* The temperature xx °C depends on the temperature class T_{class}

Power supply / Ethernet-APL™

Fieldbus terminals	BUS CONNECTION + / BUS CONNECTION -
Zone 2	FISCO Field Device, 2-WISE Power Load $T_{amb.} = -40$ to 85 °C*
U_M	<ul style="list-style-type: none"> • 17.5V for FISCO • 17.5V for liner parameters
I_{max}	380 mA
P_i	<ul style="list-style-type: none"> • 5.32 W for FISCO • 2.1 W for liner parameters
C_i	5 nF
L_i	10 μ H

Digital output

For devices with HART®, Modbus®, PROFIBUS® and Ethernet-APL communication.

The digital output is designed as an optoelectronic coupler or NAMUR contact (in accordance with DIN 19234).

- When the NAMUR contact is closed, the internal resistance is approx. 1000 Ω .
- When the contact is open, the internal resistance is > 10 k Ω .

The digital output can be changed over to ‘optoelectronic coupler’ if required.

- NAMUR with switching amplifier
- Digital output Ex nA: $U_B = 16$ to 30 V, $I_B = 2$ to 30 mA

Digital output

Terminals	DIGITAL OUTPUT 1+ / DIGITAL OUTPUT 4-
U_M	45 V
$T_{amb} = -40$ to 75 °C*	

* See temperature ranges in **Temperature Data** on page 15.

Analog input

Analog input

Terminals	ANALOG INPUT + / ANALOG INPUT -
U_M	45 V
$T_{amb} = -40$ to 75 °C	

Special conditions

- If the type of protection of the device has **not** been marked on the name plate by the manufacturer, during installation of the device, the operator must identify the type of protection used on the name plate in a **permanent** manner!
- The painted surface become electrostatically charged. If the painted surface is relatively free of contamination such as dirt, dust or oil and the relative air humidity is > 30 %, it can become a source of ignition.
- Instructions on avoiding ignition in potentially explosive environments due to electrostatic discharges in accordance with PD CLC/TR 60079-32-1 and IEC TS 60079-32-1 must be observed!
- Cleaning of the painted surface should only be done with a damp cloth.
- It must be guaranteed that the overvoltage is limited to 140 % of the maximum operating voltage of 45 V.
- It must be powered via a galvanically isolating barrier, or the equipment and the barrier will need to be connected using a 4 mm² bonding conductor when using terminal board with surge
- The temperature classification is dependent on the input parameters and the process temperature. See drawing 3KXF065215U0109.
- The ambient temperature range is -40 °C to +85 °C for Ex ec and Ex tc.
- When installed using Type of Protection 'ec' the equipment shall only be used in an area of at least pollution degree 2, as defined in IEC 60664-1.

Overvoltage protection

For the devices, the client must provide an external overvoltage protection.

It must be guaranteed that the overvoltage is limited to 140 % (HART: 63 V DC, Modbus: 42 V DC) of the maximum operating voltage U_S .

Temperature Data

Operating temperature ranges

The permissible maximum ambient temperature and measuring medium temperature are dependent on each other and on the temperature class.

- The ambient temperature range T_{amb} is -40 to 85 °C (-40 to 185 °F).
- The measuring medium temperature range T_{medium} is -55 to 400 °C (-67 to 752 °F).

Devices without LCD indicator or with LCD indicator, order code LD / LE

Temperature class	T_{amb} max.	T_{medium} max.
T4	≤ 85 °C	90 °C
	≤ 82 °C	180 °C
	≤ 81 °C	280 °C
	≤ 79 °C	400 °C
T5	≤ 56 °C	90 °C
	≤ 53 °C	180 °C
	≤ 52 °C	280 °C
	≤ 50 °C	400 °C
T6	≤ 44 °C	90 °C
	≤ 41 °C	180 °C
	≤ 40 °C	280 °C
	≤ 38 °C	400 °C

Devices with LCD indicator, order code L1

Temperature class	T_{amb} max.	T_{medium} max.
T4	≤ 85 °C	90 °C
	≤ 82 °C	180 °C
	≤ 81 °C	280 °C
	≤ 79 °C	400 °C
T5, T6	≤ 40 °C	90 °C
	≤ 37 °C	180 °C
	≤ 36 °C	280 °C
	≤ 34 °C	400 °C

... 2 Use in potentially explosive atmospheres

... Type of protection 'non-sparking' (Ex ec) and 'intrinsic safety' (Ex ic), Zone 2, 22

Devices with LCD indicator, order code L2

Temperature class	T _{amb. max.}	T _{medium max.}
T4	≤ 60 °C	90 °C
	≤ 57 °C	180 °C
	≤ 56 °C	280 °C
	≤ 54 °C	400 °C
T5	≤ 56 °C	90 °C
	≤ 53 °C	180 °C
	≤ 52 °C	280 °C
	≤ 50 °C	400 °C
T6	≤ 44 °C	90 °C
	≤ 41 °C	180 °C
	≤ 40 °C	280 °C
	≤ 38 °C	400 °C

Zone 0, 1, 20, 21 - type of protection 'intrinsically safe'

Only for devices with HART®, PROFIBUS PA® or FOUNDATION Fieldbus® communication (order code 'output signal H1, H5, P1 or F1')!

Ex marking

Note

- Only for devices with HART®, PROFIBUS PA® or FOUNDATION Fieldbus® and Ethernet-APL communication (order code '**Output signal: H1, H5, P1, F1, A1**')
- Order code '**Explosion protection: B9, N9, F9, S9**' is only suitable with order code '**Output signal: P1 and F1**' – PROFIBUS® and FOUNDATION Fieldbus®.

ATEX / IECEx

ATEX – order code 'Explosion protection: A4, B8, B9'

Type examination certificate: FM13ATEX0055X

II 1 G Ex ia IIC T4 to T6 Ga,

II 1 G Ex ia IIC T4 Ga for output signal 'A1'

II 2 D Ex ia IIIC T95 °C Db

FISCO Field Instrument, FF-816

(only with order code '**Output signal: P1 or F1**' - PROFIBUS®,

FOUNDATION Fieldbus®)

2-WISE Power Load

(only with order code '**Output signal: A1**' – Ethernet-APL)

IECEx – Order code 'Explosion protection: N2, N8, N9'

Certificate of conformity IECEx FME 13.0004X

Ex ia IIC T4 to T6 Ga,

Ex ia IIC T4 Ga for output signal 'A1'

Ex ia IIIC T95 °C Db

FISCO Field Instrument, FF-816

(only with order code '**Output signal: P1 or F1**' - PROFIBUS®,

FOUNDATION Fieldbus®)

2-WISE Power Load

(only with order code '**Output signal: A1**' – Ethernet-APL)

For electrical parameters, see certificate IECEx FME 13.0004X

FM approval for USA and Canada

FM approval for USA and Canada –

order code 'Explosion protection: F4, F8, F9'

IS Control Drawing: 3KXF065215U0109

IS/S. Intrinsic(Entity) CL I,

Zone 0 AEx/Ex ia IIC T6, T5, T4,

Zone 0 AEx/Ex ia IIC T4 for output signal 'A1'

CI I/Div 1/ABCD IS-CL II, III/DIV 1/EFG TYPE 4X

FISCO Field Instrument, FF-816

(only with order code '**Output signal: P1 or F1**' - PROFIBUS®,

FOUNDATION Fieldbus®)

2-WISE Power Load

(only with order code '**Output signal: A1**' – Ethernet-APL)

NEPSI (China)

NEPSI – order code 'Explosion protection: S6, S8, S9'

Ex ia IIC T4 to T6 Ga,

Ex ia IIC T4 to T6 Ga for output signal 'A1'

Ex ia IIIC T95 °C Db

FISCO Field Instrument, FF-816

(only with order code '**Output signal: P1 or F1**' - PROFIBUS®,

FOUNDATION Fieldbus®)

2-WISE Power Load

(only with order code '**Output signal: A1**' – Ethernet-APL)

For electrical parameters, see certificate GYJ24.1066X

... 2 Use in potentially explosive atmospheres

... Zone 0, 1, 20, 21 - type of protection 'intrinsically safe'

Electric and temperature data

The symbols used in this chapter have the following meaning.

ID code	Description
U_S	Supply voltage of the device (U_{Supply})
U_M	Maximum permissible voltage ($U_{Maximum}$)
R_B	Load resistor
I_{max}	Maximum permissible current ($I_{Maximum}$)
P_i	Maximum permissible power of the connected device
C_i	Maximum permissible inner capacity of the connected device
L_i	Maximum permissible inner inductance of the connected device

Power supply

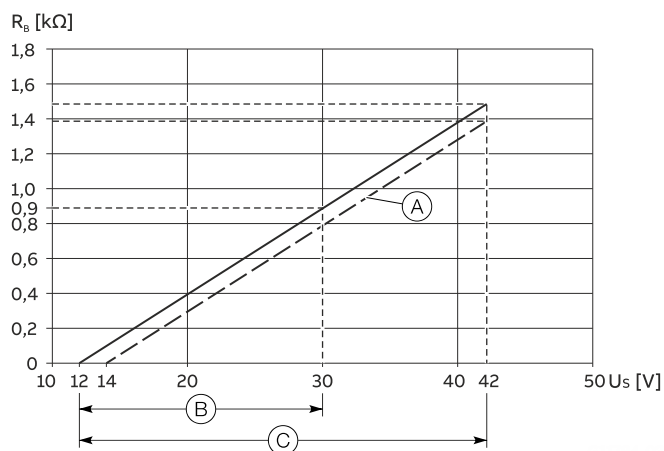

The voltage $U_S = 12$ V is based on a load of 0Ω .

R_B Maximum permissible load in the power supply circuit, e.g. indicator, recorder or power resistor.

- (A) For devices with order code **S1 – surge protection** or **G4 – enhanced EMC protection**
- (B) Type of protection Ex ia / IS
- (C) Type of protection Ex ec / NI

Figure 6: Power supply in Zone 0, 1, 20, 21 – Ex protection 'intrinsically safe'

Power supply / current output / HART® output

Terminals	PWR/COMM + / PWR/COMM -
Zone 0:	$T_{amb} = -40$ to $85 \text{ }^\circ\text{C}^*$
U_M	30 V
I_{max}	See Limit value tables on page 20
P_i	
C_i	13 nF for indicator option L1 17 nF for all other options
L_i	10 μH
Zone 20:	$T_{amb} = -40$ to $85 \text{ }^\circ\text{C}^*$

* See temperature ranges in **Limit value tables** on page 20.

Power supply and PROFIBUS PA® / FOUNDATION Fieldbus® output

Terminals	BUS CONNECTION+ / BUS CONNECTION-
Zone 0:	FISCO Field Instrument, FF-816 $T_{amb.} = -40$ to $85 \text{ }^\circ\text{C}^*$
U_M	24 V for FF-816, 17.5V for FISCO
I_{max}	See Limit value tables on page 20
P_i	1.2 W for FF-816, 5.32 W for FISCO
C_i	5 nF
L_i	10 μH

* See temperature ranges in **Limit value tables** on page 20.

Power supply and Ethernet-APL output

Terminals	BUS CONNECTION+ / BUS CONNECTION-
Zone 0	FISCO Field Device, 2-WISE Power Load $T_{amb.} = -40$ to $71 \text{ }^\circ\text{C}^*$
U_M	• 17.5V for FISCO • 17.5V for liner parameters
I_{max}	380 mA
P_i	• 5.32 W for FISCO • 2.1 W for liner parameters
C_i	5 nF
L_i	10 μH

Digital output

The digital output is designed as an optoelectronic coupler or NAMUR contact (in accordance with DIN 19234).

- When the NAMUR contact is closed, the internal resistance is approx. 1000 Ω .
- When the NAMUR contact is open, the internal resistance is $> 10 \text{ k}\Omega$.

The digital output can be changed over to 'optoelectronic coupler' if required.

- NAMUR with switching amplifier
- Digital output: Ex ia: $U_i = 30$ V DC

Digital output

Terminals	DIGITAL OUTPUT 1+ / DIGITAL OUTPUT 4-
Zone 0:	
U_{max}	30 V
I_{max}	30 mA
C_i	7 nF
L_i	0 mH
Zone 20:	$T_{amb} = -40$ to $85 \text{ }^\circ\text{C}^*$

Analog input

Analog input	
Terminals	ANALOG INPUT + / ANALOG INPUT -
Zone 0:	
U_{max}	See Limit value tables on page 20
I_{max}	
C_i	7 nF
L_i	0 mH
Zone 20:	$T_{amb} = -40$ to $85\text{ }^{\circ}\text{C}^*$

* See temperature ranges in **Limit value tables** on page 20.

Special conditions

- If the type of protection of the device has **not** been marked on the name plate by the manufacturer, during installation of the device, the operator must identify the type of protection used on the name plate in a **permanent** manner!
- The painted surface become electrostatically charged. If the painted surface is relatively free of contamination such as dirt, dust or oil and the relative air humidity is > 30%, it can become a source of ignition.
- Instructions on avoiding ignition in potentially explosive environments due to electrostatic discharges in accordance with PD CLC/TR 60079-32-1 and IEC TS 6007932-1 must be observed! Cleaning of the painted surface should only be done with a damp cloth.
- In devices with the order option '**Housing material / cable connection – A1 or B1**', the transmitter housing is made of aluminum and can form a source of ignition through the creation of sparks due to mechanical friction or impact.
 - When working on the devices, only use tools that are approved for working with aluminum in potentially explosive atmospheres.
 - Avoid mechanical friction and impacts on aluminum components.
- It must be powered via a galvanically isolating barrier, or the equipment and the barrier will need to be connected using a 4 mm² bonding conductor when using terminal board with surge.
- The temperature classification is dependent on the input parameters and the process temperature. See drawing 3KXF065215U0109.

Devices with extended EMC-protection

For devices with the order code '**Optional equipment for devices – G4**', power circuits must be connected to the device through galvanically isolated safety barriers.

Devices with PROFIBUS PA® or FOUNDATION Fieldbus® output

- For devices in remote mount design, the fieldbus must be connected to the device through galvanically isolated safety barriers.
- The power supply, digital output and the analog input must be considered as separate intrinsically safe circuits. If the power supply, digital output and analog input are routed in a common multi core cable, the laying and installation of the cable must comply with regulations for separate intrinsically safe circuits.

... 2 Use in potentially explosive atmospheres

... Zone 0, 1, 20, 21 - type of protection 'intrinsically safe'

Limit value tables

Operating temperature ranges

- The ambient temperature range T_{amb} of the devices is -40 to 85 °C
- The measuring medium temperature range T_{medium} is -55 to 400 °C

Devices without LCD indicator or with LCD indicator, order code 'LD, LE'

Devices with HART® communication – order code 'Output signal – H1 and H5'

Temperature class	T_{amb} max.	U_M	I_{max}	P_i max	T_{medium} max.
Power supply, current / HART® output, analog input					
T4*	≤ 85 °C	30 V	100 mA	0.75 W	90 °C
	≤ 82 °C				180 °C
	≤ 81 °C				280 °C
	≤ 79 °C				400 °C
T4*	≤ 70 °C	30 V	160 mA	1.0 W	90 °C
	≤ 67 °C				180 °C
	≤ 66 °C				280 °C
	≤ 64 °C				400 °C
T5	≤ 56 °C	30 V	100 mA	1.4 W	90 °C
	≤ 53 °C				180 °C
	≤ 52 °C				280 °C
	≤ 50 °C				400 °C
T6	≤ 44 °C	30 V	50 mA	0.4 W	90 °C
	≤ 41 °C				180 °C
	≤ 40 °C				280 °C
	≤ 38 °C				400 °C
Digital output					
T4	≤ 85 °C	30 V	30 mA	1.0 W	90 °C
	≤ 82 °C				180 °C
	≤ 81 °C				280 °C
	≤ 79 °C				400 °C
T5	≤ 56 °C	30 V	30 mA	1.0 W	90 °C
	≤ 53 °C				180 °C
	≤ 52 °C				280 °C
	≤ 50 °C				400 °C
T6	≤ 44 °C	30 V	30 mA	1.0 W	90 °C
	≤ 41 °C				180 °C
	≤ 40 °C				280 °C
	≤ 38 °C				400 °C

* Depending on the electric data of the connected supply isolator.

Devices with LCD indicator, order code 'L1'

Devices with HART® communication – order code 'Output signal – H1 and H5'

Temperature class	T _{amb} max.	U _M	I _{max}	T _{medium} max.
Power supply, current / HART® output, analog input				
T4*	≤ 85 °C	30 V	100 mA	90 °C
	≤ 82 °C			180 °C
	≤ 81 °C			280 °C
	≤ 79 °C			400 °C
T4*	≤ 70 °C	30 V	160 mA	90 °C
	≤ 67 °C			180 °C
	≤ 66 °C			280 °C
	≤ 64 °C			400 °C
T5	≤ 40 °C	30 V	100 mA	90 °C
	≤ 37 °C			180 °C
	≤ 36 °C			280 °C
	≤ 34 °C			400 °C
T6	≤ 40 °C	30 V	50 mA	90 °C
	≤ 37 °C			180 °C
	≤ 36 °C			280 °C
	≤ 34 °C			400 °C
Digital output				
T4	≤ 85 °C	30 V	30 mA	90 °C
	≤ 82 °C			180 °C
	≤ 81 °C			280 °C
	≤ 79 °C			400 °C
T5	≤ 40 °C	30 V	30 mA	90 °C
	≤ 37 °C			180 °C
	≤ 36 °C			280 °C
	≤ 34 °C			400 °C
T6	≤ 40 °C	30 V	30 mA	90 °C
	≤ 37 °C			180 °C
	≤ 36 °C			280 °C
	≤ 34 °C			400 °C

* Depending on the electric data of the connected supply isolator.

... 2 Use in potentially explosive atmospheres

... Zone 0, 1, 20, 21 - type of protection 'intrinsically safe'

Devices with LCD indicator, order code 'L2' (operation through the front glass)

Devices with HART® communication – order code 'Output signal – H1 and H5'

Temperature class	T _{amb} max.	U _{Mx}	I _{max}	P _i max	T _{medium} max.
Power supply, current / HART® output, analog input					
T4*	≤ 60 °C	30 V	100 mA	0.75 W	90 °C
	≤ 57 °C				180 °C
	≤ 56 °C				280 °C
	≤ 54 °C				400 °C
T4*	≤ 60 °C	30 V	160 mA	1.0 W	90 °C
	≤ 57 °C				180 °C
	≤ 56 °C				280 °C
	≤ 54 °C				400 °C
T5	≤ 56 °C	30 V	100 mA	1.4 W	90 °C
	≤ 53 °C				180 °C
	≤ 52 °C				280 °C
	≤ 50 °C				400 °C
T6	≤ 44 °C	30 V	50 mA	0.4 W	90 °C
	≤ 41 °C				180 °C
	≤ 40 °C				280 °C
	≤ 38 °C				400 °C
Digital output					
T4	≤ 60 °C	30 V	30 mA	1.0 W	90 °C
	≤ 57 °C				180 °C
	≤ 56 °C				280 °C
	≤ 54 °C				400 °C
T5	≤ 56 °C	30 V	30 mA	1.0 W	90 °C
	≤ 53 °C				180 °C
	≤ 52 °C				280 °C
	≤ 50 °C				400 °C
T6	≤ 44 °C	30 V	30 mA	1.0 W	90 °C
	≤ 41 °C				180 °C
	≤ 40 °C				280 °C
	≤ 38 °C				400 °C

* Depending on the electric data of the connected supply isolator.

Devices with PROFIBUS PA® or FOUNDATION Fieldbus® communication – order code 'Output signal – P1 and F1'

Temperature class	T _{amb} max.	U _M	I _{max}	P _i max	T _{medium} max.
Power supply					
T4	≤ 85 °C				90 °C
	≤ 82 °C				180 °C
	≤ 81 °C				280 °C
	≤ 79 °C				400 °C
T5, T6	≤ 40 °C				90 °C
	≤ 37 °C				180 °C
	≤ 36 °C				280 °C
	≤ 34 °C				400 °C
Digital output					
T4	≤ 85 °C	30 V	30 mA	1.0 W	90 °C
	≤ 82 °C				180 °C
	≤ 81 °C				280 °C
	≤ 79 °C				400 °C
T5, T6	≤ 40 °C	30 V	30 mA	1.0 W	90 °C
	≤ 37 °C				180 °C
	≤ 36 °C				280 °C
	≤ 34 °C				400 °C
Analog input					
T4*	≤ 85 °C	30 V	100 mA	0.75 W	90 °C
	≤ 82 °C				180 °C
	≤ 81 °C				280 °C
	≤ 79 °C				400 °C
T4*	≤ 70 °C	30 V	160 mA	1.0 W	90 °C
	≤ 67 °C				180 °C
	≤ 66 °C				280 °C
	≤ 64 °C				400 °C
T5	≤ 40 °C	30 V	100 mA	1.4 W	90 °C
	≤ 37 °C				180 °C
	≤ 36 °C				280 °C
	≤ 34 °C				400 °C
T6	≤ 40 °C	30 V	50 mA	0.4 W	90 °C
	≤ 37 °C				180 °C
	≤ 36 °C				280 °C
	≤ 34 °C				400 °C

* Depending on the electric data of the connected supply isolator.

... 2 Use in potentially explosive atmospheres

... Zone 0, 1, 20, 21 - type of protection 'intrinsically safe'

Devices with Ethernet-APL™ communication – order code 'Output signal – A1'

Temperature class	T _{amb} max.	U _M	I _{max}	P _i max	T _{medium} max.
Power supply					
T4	≤ 71 °C				70 °C
	≤ 69 °C				90 °C
	≤ 66 °C				180 °C
	≤ 63 °C				280 °C
	≤ 60 °C				400 °C
Digital output					
T4	≤ 71 °C	30 V	30 mA	1.0 W	70 °C
	≤ 69 °C				90 °C
	≤ 66 °C				180 °C
	≤ 63 °C				280 °C
	≤ 60 °C				400 °C
Analog input					
T4*	≤ 71 °C	30 V	100 mA	0.75 W	70 °C
	≤ 69 °C				90 °C
	≤ 66 °C				180 °C
	≤ 63 °C				280 °C
	≤ 60 °C				400 °C
T4*	≤ 71 °C	30 V	160 mA	1.0 W	70 °C
	≤ 69 °C				90 °C
	≤ 66 °C				180 °C
	≤ 63 °C				280 °C
	≤ 60 °C				400 °C

* Depending on the electric data of the connected supply isolator.

Type of protection ‘flameproof (enclosure)’ – Zone 1, 21

Ex marking

Note

Order code ‘Explosion protection: B9, N9, F9, S9’ is only suitable with order code ‘Output signal: P1 and F1’ – PROFIBUS® and FOUNDATION Fieldbus®.

ATEX / IECEx

ATEX – order code ‘Explosion protection: A9, B9’

Type Examination Test Certificate FM13ATEX0057X

II 2 G Ex db ia IIC T6 Gb/Ga – II 2 D Ex tb IIIC T85 °C Db

(–40 °C < Ta < +75 °C) supply voltage 42 V DC,

Um: 45 V

IECEx – order code ‘Explosion protection: N3, N9’

Certificate of conformity IECEx FME 13.0004X

Ex db ia IIC T6 Gb/Ga-Ex tb IIIC T85 °C Db

(–40 °C < Ta < +75 °C) supply voltage 42 V DC,

Um = 45 V

FM approval for USA and Canada

FM approval for USA and Canada –

order code ‘Explosion protection: F1, F9’

XP-IS (US) CL I/DIV I/GP BCD, DIP CL II, III/DIV I/GP EFG

XP-IS (Canada) CL I/DIV I/GP BCD, DIP CL II, III/DIV I/GP EFG

CL I, ZONE 1, AEx/Ex d ia IIC T6 –40 °C < Ta < +75 °C

TYPE 4X Tamb = 75 °C ‘Dual seal device’

NEPSI (China)

NEPSI – order code ‘Explosion protection: S1, S9’

Ex db ia IIC T6 Gb/Ga

Ex tb IIIC T85 °C Db

For electrical parameters, see certificate GYJ24.1066X

Electric and temperature data

The symbols used in this chapter have the following meaning.

ID code	Description
U_S	Supply voltage of the device (U_{Supply})
U_M	Maximum permissible voltage ($U_{Maximum}$)
R_B	Load resistor

Power supply

Ex d ia Gb/Ga:

$U_S = 12$ to 42 V DC

Note

- The power supply and the digital output must be either only intrinsically safe or only non-intrinsically safe. A combination is not permitted.
- Intrinsically safe circuits must have potential equalization in place along the entire length of the cable of the circuit.

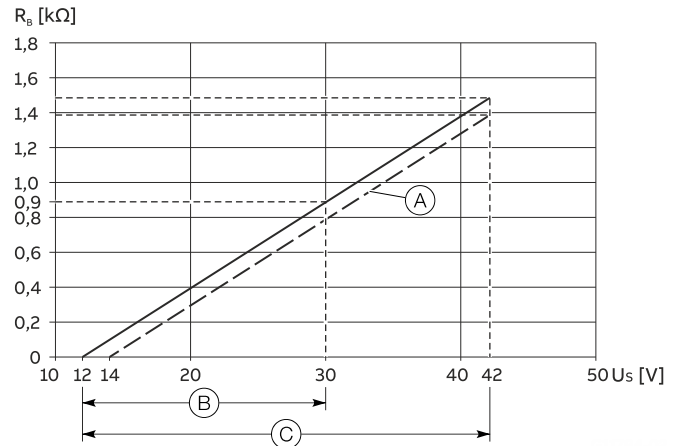

The voltage $U_S = 12$ V is based on a load of 0 Ω .

R_B Maximum permissible load in the power supply circuit, e.g. indicator, recorder or power resistor.

(A) For devices with order code **S1 – surge protection** or **G4 – enhanced EMC protection**

(B) Type of protection Ex ec, ia / NI, IS (Modbus devices)

(C) Type of protection Ex ec, d, ia / NI, IS (HART devices)

Figure 7: Power supply in Zone 1, explosion protection

Power supply / current output / HART® output, Modbus®

HART terminals PWR/COMM + / PWR/COMM –

Modbus terminals A (+), B (–) / PWR +, PWR –

U_M HART: 45 V, Modbus: 30 V

T_{amb} –40 to 75 °C

... 2 Use in potentially explosive atmospheres

... Type of protection ‘flameproof (enclosure)’ – Zone 1, 21

Digital output

The digital output is designed as an optoelectronic coupler or NAMUR contact (in accordance with DIN 19234).

- When the NAMUR contact is closed, the internal resistance is approx. 1000 Ω .
- When the NAMUR contact is open, the internal resistance is $> 10 \text{ k}\Omega$.

The digital output can be changed over to ‘optoelectronic coupler’ if required.

- NAMUR with switching amplifier
- Digital output: Ex d ia: $U_M = 45 \text{ V}$

Digital output

Terminals	DIGITAL OUTPUT 1+ / DIGITAL OUTPUT 4-
U_M	45 V
T_{amb}	-40 to 75 °C

Analog input

Analog input

Terminals	ANALOG INPUT + / ANALOG INPUT -
U_M	45 V
T_{amb}	-40 to 75 °C

Special conditions

- If the type of protection of the device has **not** been marked on the name plate by the manufacturer, during installation of the device, the operator must identify the type of protection used on the name plate in a **permanent** manner!
- Consult the manufacturer if dimensional information on the flameproof joints is necessary.
- The painted surface become electrostatically charged. If the painted surface is relatively free of contamination such as dirt, dust or oil and the relative air humidity is $> 30\%$, it can become a source of ignition.
- Instructions on avoiding ignition in potentially explosive environments due to electrostatic discharges in accordance with PD CLC/TR 60079-32-1 and IEC TS 60079-32-1 must be observed!
- Cleaning of the painted surface should only be done with a damp cloth.
- In devices with the order option ‘Housing material / cable connection – A1 or B1’, the transmitter housing is made of aluminum and can form a source of ignition through the creation of sparks due to mechanical friction or impact.
 - When working on the devices, only use tools that are approved for working with aluminum in potentially explosive atmospheres.
 - Avoid mechanical friction and impacts on aluminum components.

Repair

Devices of explosion protection class of ‘flameproof enclosure / Flameproof enclosure’ are equipped with flameproof open joints in the housing.

Contact ABB before commencing repair work.

Repair

Devices of explosion protection class of ‘flameproof enclosure / Flameproof enclosure’ are equipped with flameproof open joints in the housing.

Contact ABB before commencing repair work.

3 Design and function

Overview

SwirlMaster FSS430 / FSS450



① Integral mount design

② Remote mount design with transmitter

③ Remote mount design with dual sensor

Figure 8: SwirlMaster FSS430 / FSS450

Sensor		
Model number	FSS430	FSS450
Design	Integral mount design, remote mount design	
IP degree of protection in accordance with EN 60529	IP 66 / 67, NEMA 4X	
Measuring accuracy for liquids *	≤ ±0.5 % under reference conditions	
Measuring accuracy for gases and vapors *	≤ ±0.5 % under reference conditions	
Repeatability *	DN 15 ≤ ±0.3 %, from DN 20 ≤ ±0.2 %	
Permissible viscosity for liquids	DN 15 to 32: ≤ 5 mPa s, DN 40 to 50: ≤ 10 mPa s, from DN 80: ≤ 30 mPa s	
Measuring span (typical)	1:25	
Process connections	Flange DN 15 to 400 (0.5 in to 16 in)	Flange DN 15 to 400 (0.5 in to 16 in)
Inlet / outlet sections (typical)	Inlet section: 3 × DN, outlet section 1 × DN, see also Inlet and outlet sections on page 36.	
Temperature measurement	Resistance thermometer Pt100 class A optional, installed in Piezo sensor, can be retrofitted	Resistance thermometer Pt100 class A standard, fixed installation in Piezo sensor
Permissible measuring medium temperature	Standard: -55 to 280 °C (-67 to 536 °F), Optional: -55 to 350 °C(-67 to 662 °F)	Standard: -55 to 280 °C (-67 to 536 °F), Optional: -55 to 350 °C(-67 to 662 °F)
Wetted material		
• Sensor	Stainless steel, optional Hastelloy® C	
• Inlet / outlet guide bodies	Stainless steel, optional Hastelloy® C	
• Gasket	PTFE, optional Kalrez® or graphite	
• Sensor housing	Stainless steel, optional Hastelloy® C	
Sensor design	Piezo sensor with two pairs of sensors for flow measurement and vibration compensation	
Approvals for explosion protection	ATEX / IECEx, cFMus, NEPSI	

* Indication of accuracy in % of the measured value

... 3 Design and function

... Overview

VortexMaster FSV430 / FSV450



- ① Integral mount design in flange design
 ② Integral mount design in wafer type design
 ③ Remote mount design with transmitter
 ④ Remote mount design with dual sensor

Figure 9: VortexMaster FSV430 / FSV450

Sensor		
Model number	FSV430	FSV450
Design	Integral mount design, remote mount design	
IP degree of protection in accordance with EN 60529	IP 66, IP 67, NEMA 4X	
Measuring accuracy for liquids*	≤ ±0.65 % under reference conditions	
Measuring accuracy for gases and vapors*	≤ ±0.9 % under reference conditions	
Repeatability*	DN 15 (½ in): ≤ ±0.3 %, DN 15 (½ in) to DN 150 (6 in): ≤ ±0.2 %, from DN 200 (8 in): ≤ ±0.25 %	
Permissible viscosity for liquids	DN 15 (½ in): ≤ 4 mPa s, DN 25 (1 in): ≤ 5 mPa s, from DN 40 (1½ in): ≤ 7.5 mPa s	
Measuring span (typical)	1:20	
Process connections	<ul style="list-style-type: none"> Flange: DN 15 to 300 (½ in to 12 in) Wafer type: DN 25 to 150 (1 in to 6 in) 	
Inlet / outlet sections (typical)	Inlet section: 15 × DN, outlet section 5 × DN, see also Inlet and outlet sections on page 36.	
Temperature measurement	Resistance thermometer Pt100 class A optional, installed in Piezo sensor, can be retrofitted	Resistance thermometer Pt100 class A standard, fixed installation in Piezo sensor
Permissible measuring medium temperature	Standard: -55 to 280 °C (-67 to 536 °F), Optional: -55 to 350 °C (-67 to 662 °F)	Standard: -55 to 280 °C (-67 to 536 °F), Optional: -55 to 350 °C (-67 to 662 °F)
Wetted material		
• Sensor	Stainless steel, optional Hastelloy® C	
• Gasket	PTFE, optional Kalrez® or graphite	
• Sensor housing	Stainless steel, optional Hastelloy® C, carbon steel	
Sensor design	Piezo sensor with two pairs of sensors for flow measurement and vibration compensation	
Approvals for explosion protection	ATEX / IECEx, cFMus, NEPSI	

* Indication of accuracy in % of the measured value

Transmitter

Model number	FSS430 / FSV430	FSS450 / FSV450
Display	<ul style="list-style-type: none"> LCD indicator with four operating buttons (Standard, Order Code 'L1') LCD indicator with four operating buttons and TTG (Through-the-glass) operation (Option, Order Code 'L2', only available for Modbus RTU®, PROFIBUS PA® and FOUNDATION Fieldbus®) Smart LCD indicator* (Smart HMI) with four operating buttons and TTG (Through-the-glass) operation and Bluetooth™ configuration (Option, Order Code 'LE') 	
Operating modes		
• Liquids	Operating volume, mass	Operating volume, mass
• Gases	Operating volume, standard volume, mass	Operating volume, standard volume, mass
• Steam	Operating volume, mass	Operating volume, mass, energy
Digital output (Not for devices with FOUNDATION Fieldbus® communication)	Optional, can be configured as pulse output, frequency output or alarm output via software	Standard, can be configured as pulse output, frequency output or alarm output via software
Inputs for external sensors (Only for devices with HART® communication)	<ul style="list-style-type: none"> HART® input** for external pressure or temperature transmitter communicating in HART burst mode 	<ul style="list-style-type: none"> Analog input 4 to 20 mA for external pressure- / temperature transmitter or density signal HART® input** for external pressure- / temperature transmitter communicating in HART burst mode
Current output, communication	4 to 20 mA, HART® (HART 7), Modbus RTU®, PROFIBUS PA®, FOUNDATION Fieldbus®, Ethernet-APL™ with PROFINET®, Modbus TCP® and Webserver over Ethernet communication	
SensorMemory	Saves sensor & process parameters for easy start-up after transmitter exchange	
Housing material	Aluminum (copper content < 0.3 %), epoxy resin coated; optional: stainless steel CF3M, complies with AISI 316L Tower: CF3M, complies with AISI 316L	
IP degree of protection in accordance with EN 60529	IP 66, IP 67, NEMA 4X	

* Devices with Ethernet-APL communication are supplied with the Smart HMI as standard.

** Only for devices with HART® communication

... 3 Design and function

Model variants

SwirlMaster FSS430 / VortexMaster FSV430

Vortex flowmeter / swirl flowmeter for steam, liquid and gas, with optional graphical display, optional binary output, and optional integrated temperature measurement.

SwirlMaster FSS450 / VortexMaster FSV450

Vortex flowmeter / swirl flowmeter for steam, liquid and gas, with integrated binary output, temperature compensation, and flow measurement calculation functionality.

The device offers the option of directly connecting remote temperature transmitters, pressure transmitters, or gas analyzers.

Measurement principle

SwirlMaster FSS430 / FSS450

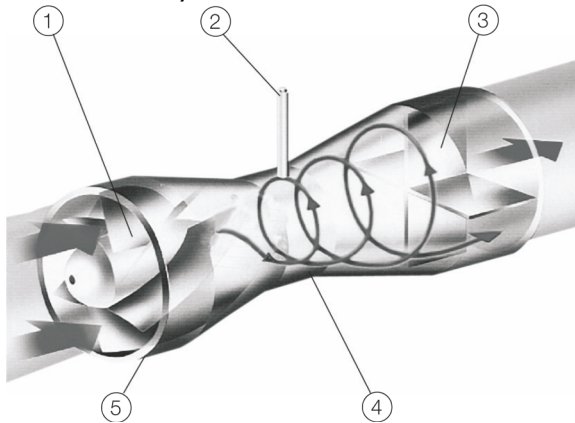

- ① Inlet guide body
- ② Piezo Sensor
- ③ Outlet guide body
- ④ Housing
- ⑤ Stagnation point

Figure 10: Measuring principle

The inlet guide body converts the axial flow of the incoming measuring medium into rotational movement. In the center of this rotation a vortex core is formed which is forced into a secondary spiral-shaped rotation by the return flow.

The frequency of this secondary rotation is proportional to the flow and, if the internal geometry of the meter measuring device exhibits an optimum design, will be linear over a wide measuring range.

This frequency is measured by a Piezo sensor. The frequency signal from the flowmeter sensor, which is proportional to the flow, undergoes downstream processing in the transmitter.

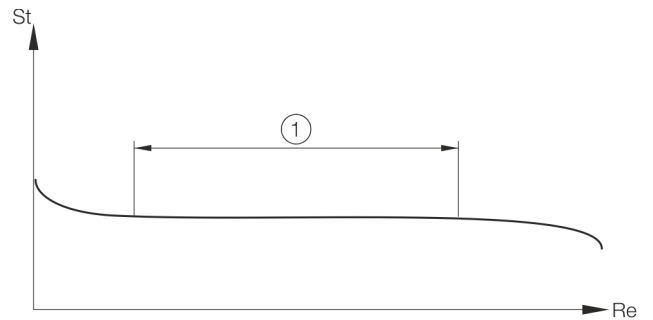

- ① Linear flow area

Figure 11: How the Strouhal number is dependent upon the Reynolds number

Due to the dimensions of the inlet guide body and the inner geometry, the Strouhal number (St) is constant over a very wide range of the Reynolds number (Re).

VortexMaster FSV430 / FSV450

The operating principle of the Vortex flowmeter is based on the Karman street. As the measuring medium flows over and under the bluff body, vortices are shed alternately above and below. The shedding of these vortices due to the flow forms a vortex trail (Karman vortex street).

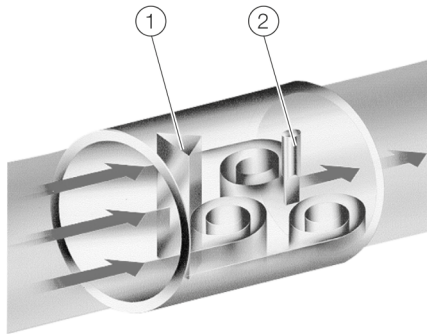

- ① Bluff body
- ② Piezo Sensor

Figure 12: Measuring principle

Here, the frequency f of vortex shedding is proportional to the medium velocity v and inversely proportional to the width of the bluff body d .

$$f = St \times \frac{v}{d}$$

St , known as the Strouhal number, is a dimensionless number, which has a decisive impact on the quality of vortex flow measurement.

If the bluff body is dimensioned appropriately, the Strouhal number (St) remains constant across a very wide range of the Reynolds number (Re).

$$Re = \frac{v \times D}{\varrho}$$

- ϱ Kinematic viscosity
 - D Nominal diameter of meter tube
-

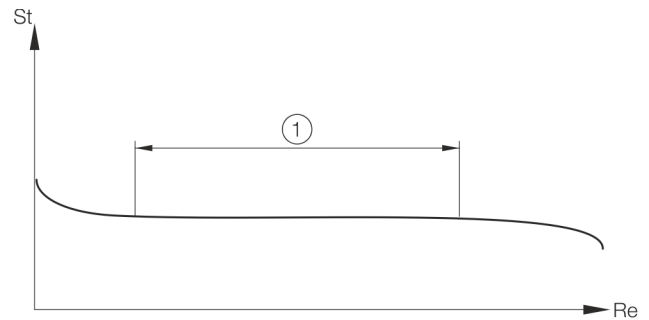

- ① Linear flow area

Figure 13: How the Strouhal number is dependent upon the Reynolds number

Consequently, the vortex shedding frequency to be evaluated is dependent solely upon the flow velocity and not at all upon measuring medium density and viscosity.

The local pressure variations induced by vortex shedding are detected by a piezo sensor and converted into electrical pulses corresponding to the vortex frequency.

The frequency signal from the flowmeter sensor, which is proportional to the flow, undergoes downstream processing in the transmitter.

... 3 Design and function

Available LCD indicator variants

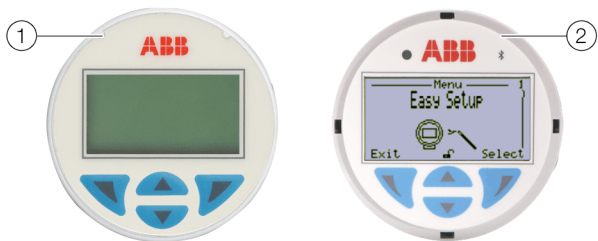

- ① Standard LCD indicator and LCD indicator with TTG (Through-The-Glass) keypad technology
- ② Smart LCD indicator (Smart HMI)

Figure 14: LCD indicator variants

Order code 'Integrated Digital Display (LCD)'				
Order Code	Description	L1	L2	LE
L1	LCD indicator			
L2	LCD indicator with TTG (Through-The-Glass) keypad technology			
LE	Smart LCD indicator			

Signal output / Communication	Order Code	L1	L2	LE
'Output Signal'				
4 to 20 mA/HART®	H1, H5	X	—	X
Ethernet-APL™	A1	—	—	X
Modbus RTU®	M4	X	X	—
PROFIBUS PA®	P1	X	X	—
FOUNDATION Fieldbus®	F1	X	X	—
Bluetooth®	—	—	—	X

4 Product identification

Name plate

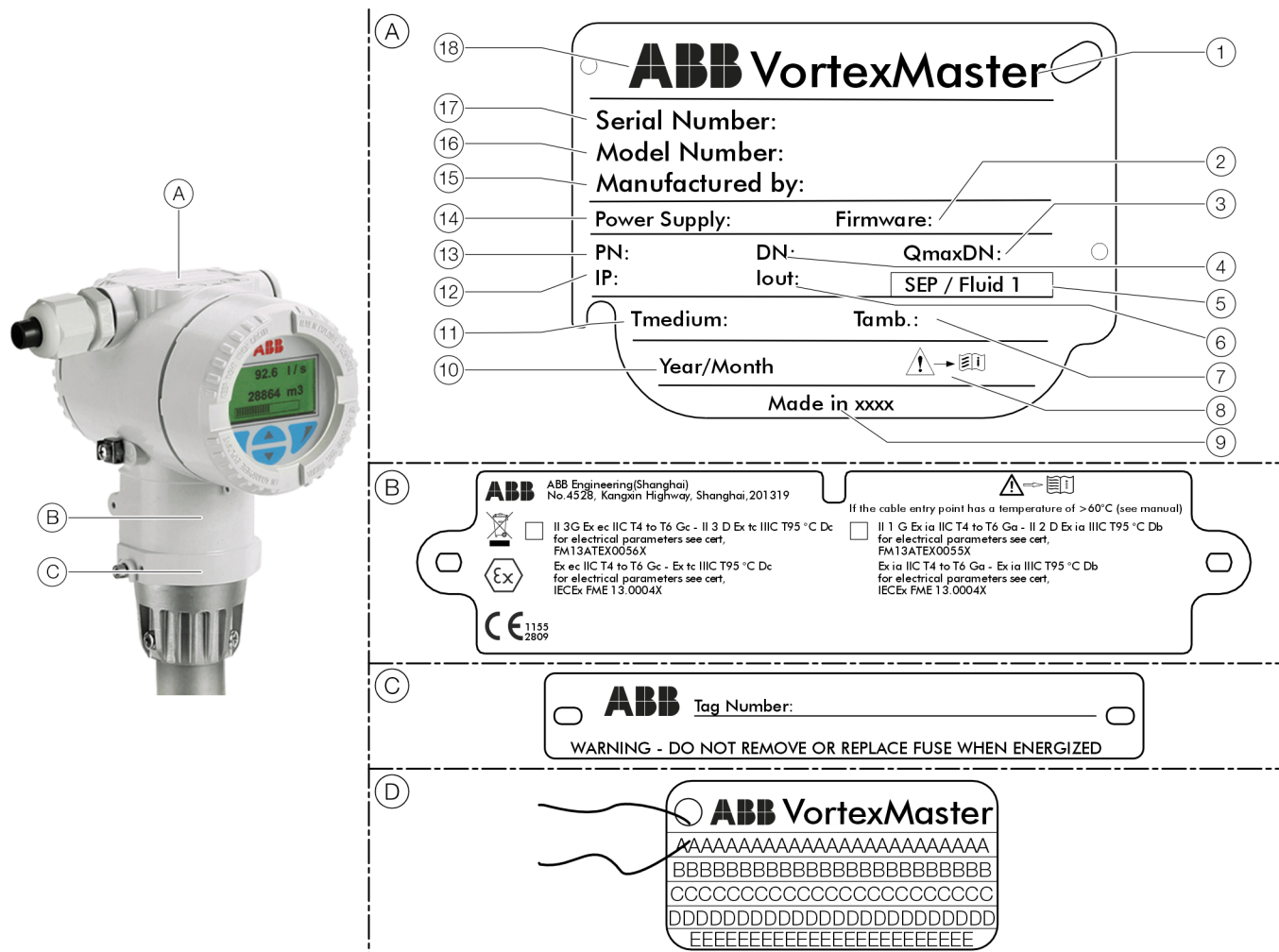

- Ⓐ Name plate
- Ⓑ Additional plate with Ex marking
- Ⓒ Plate with measuring point tagging (Tag number)
- Ⓓ Tag plate with customer data made from stainless steel (optional)
- ① Product name
- ② Firmware version
- ③ Maximum flow rate at nominal diameter
- ④ Nominal diameter
- ⑤ Pressure equipment classification (SEP or fluid group)
- ⑥ Current output
- ⑦ Maximum ambient temperature
- ⑧ Symbol: read instruction before use
- ⑨ Country of manufacture
- ⑩ Date of manufacture
- ⑪ Maximum measuring medium temperature
- ⑫ IP rating
- ⑬ Pressure rating
- ⑭ Power supply
- ⑮ Manufacturer address
- ⑯ Model number
- ⑰ Serial number
- ⑱ Manufacturer logo

Figure 15: Types and tag plates (example)

Note

The device can optionally be delivered with a tag plate (Ⓓ) made from stainless steel and fastened with wire. Customer specific text that has been specified in the purchase order is laser printed on the tag plate.

For this, 4 lines of 32 characters each are provided.

5 Transport and storage

Inspection

Check the devices immediately after unpacking for possible damage that may have occurred from improper transport. Details of any damage that has occurred in transit must be recorded on the transport documents. All claims for damages must be submitted to the shipper without delay and before installation.

Transport

⚠ DANGER

Life-threatening danger due to suspended loads.
In the case of suspended loads, a danger of the load falling exists.

- Standing under suspended loads is prohibited.

⚠ WARNING

Risk of injury due to device slipping.
The device's center of gravity may be higher than the harness suspension points.

- Make sure that the device does not slip or turn during transport.
- Support the device laterally during transport.

Flange devices ≤ DN 300

- Use carrying straps to transport flange designs smaller than DN 350.
- Wrap the carrying straps around both process connections when lifting the device. Chains should not be used, since these may damage the housing.

Flange devices > DN 300

- Using a forklift to transport flange device can dent the housing.
- Flange devices must not be lifted by the center of the housing when using a forklift for transport.
- Flange devices must not be lifted by the terminal box or by the center of the housing.
- Only the transport lugs fitted to the device can be used to lift the device and insert it into the piping.

Storing the device

- Bear the following points in mind when storing devices:
- Store the device in its original packaging in a dry and dust-free location.
 - Observe the permitted ambient conditions for transport and storage.
 - Avoid storing the device in direct sunlight.
 - In principle, the devices may be stored for an unlimited period. However, the warranty conditions stipulated in the order confirmation of the supplier apply.

Ambient conditions

The ambient conditions for the transport and storage of the device correspond to the ambient conditions for operation of the device.

Refer to **Ambient conditions** on page 34.

Returning devices

For the return of devices, follow the instructions in **Repair** on page 147.

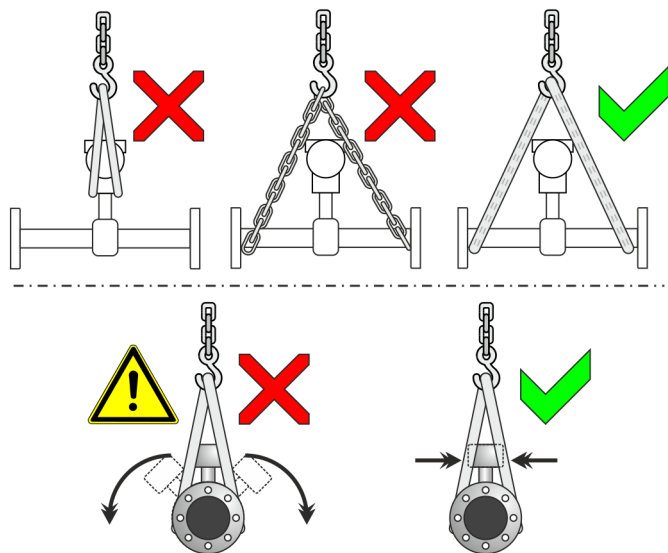

Figure 16: Transport instructions

6 Installation

Safety instructions

DANGER

Danger of explosion if the device is operated with the transmitter housing or terminal box open!

Before opening the transmitter housing or the terminal box, note the following points:

- Check that a valid fire permit is available.
- Make sure that there is no explosion hazard.
- Before opening the device, switch off the power supply and wait for $t > 2$ minutes.

WARNING

Risk of injury due to process conditions.

The process conditions, for example high pressures and temperatures, toxic and aggressive measuring media, can give rise to hazards when working on the device.

- Before working on the device, make sure that the process conditions do not pose any hazards.
- If necessary, wear suited personal protective equipment when working on the device.
- Depressurize and empty the device / piping, allow to cool and purge if necessary.

Installation conditions

General

A Vortex or Swirl flowmeter can be installed at any point in the pipeline system. However, the following installation conditions must be considered:

- Compliance with the ambient conditions
- Compliance with the recommended inlet and outlet sections
- The flow direction must correspond to that indicated by the arrow on the sensor
- Compliance with the required minimum interval for removing the transmitter and replacing the sensor
- Avoidance of mechanical vibrations of the piping (by fitting supports if necessary)
- The inside diameter of the sensor and the piping must be identical
- Avoidance of pressure oscillations in long piping systems at zero flow by fitting gates at intervals
- Attenuation of alternating (pulsating) flow by using appropriate damping devices. The residual pulse must not exceed 10 %. The frequency of the conveying equipment must not be within the range of the measuring frequency of the flowmeter.
- Valves / gates should normally be arranged in the flow direction downstream of the flowmeter (typically: $3 \times DN$). If the medium is conveyed through piston / plunger pumps or compressors (pressures for fluids > 10 bar / 145 psi), it may be subject to hydraulic vibration in the pipeline when the valve is closed. If this does occur, the valve absolutely has to be installed in the flow direction upstream of the flowmeter. Suitable damping devices (e.g. air vessels) might need to be fitted.
- When fluids are measured, the sensor must always be filled with measuring medium and must not run dry.
- When fluids are measured and during damping, there must be no evidence of cavitation.
- The relationship between the measuring medium and the ambient temperature must be taken into consideration (see data sheet).
- At high measuring medium temperatures > 150 °C (> 302 °F), the sensor must be installed so that the transmitter or terminal box is pointing to the side or downward.

... 6 Installation

... Installation conditions

Inlet and outlet sections

SwirlMaster FSS430, FSS450

On account of its operating principle, the swirl flowmeter functions virtually without inlet and outlet sections.

The figures below show the recommended inlet and outlet sections for various installations.

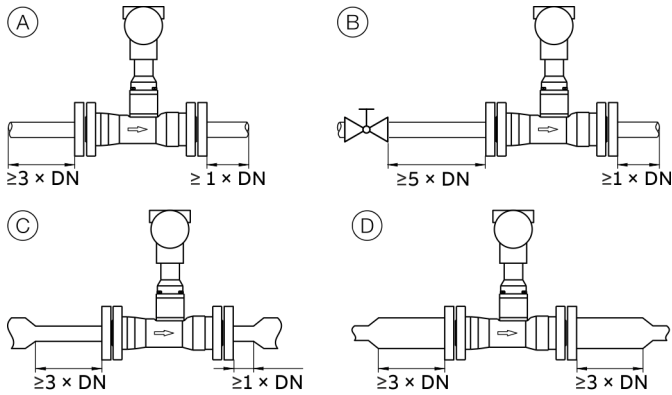

Figure 17: Straight pipe sections

Installation	Inlet section	Outlet section
(A) Straight pipe section	min. $3 \times DN$	min. $1 \times DN$
(B) Valve upstream of the meter tube	min. $5 \times DN$	min. $1 \times DN$
(C) Pipe reduction	min. $3 \times DN$	min. $1 \times DN$
(D) Pipe extension	min. $3 \times DN$	min. $3 \times DN$

Additional inlet and outlet sections are not required downstream of reductions with flange transition pieces in accordance with DIN 28545 ($\alpha/2 = 8^\circ$).

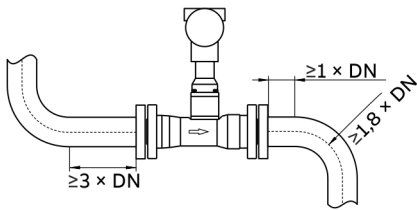

Figure 18: Pipe sections with pipe elbows

Installation	Inlet section	Outlet section
Single pipe elbow upstream or downstream of the meter tube	min. $3 \times DN$	min. $1 \times DN$

If the elbow radius of single or double pipe elbows positioned upstream or downstream of the device is greater than $1.8 \times DN$, inlet and outlet sections are not required.

VortexMaster FSV430, FSV450

In order to maximize operational reliability, the flow profile at the inflow end must not be distorted if at all possible.

The figures below show the recommended inlet and outlet sections for various installations.

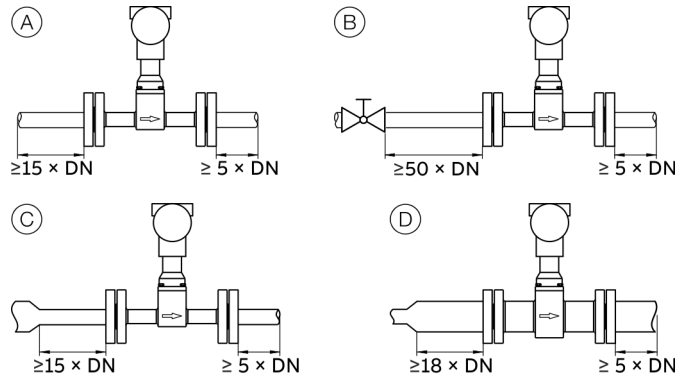

Figure 19: Straight pipe sections

Installation	Inlet section	Outlet section
(A) Straight pipe section	min. $15 \times DN$	min. $5 \times DN$
(B) Valve upstream of the meter tube	min. $50 \times DN$	min. $5 \times DN$
(C) Pipe reduction	min. $15 \times DN$	min. $5 \times DN$
(D) Pipe extension	min. $18 \times DN$	min. $5 \times DN$

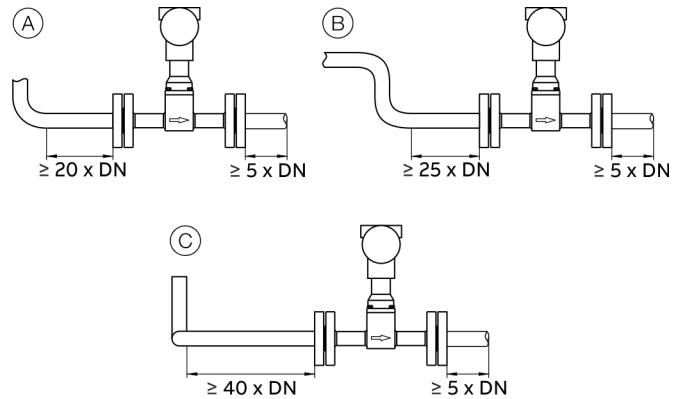

Figure 20: Pipe sections with pipe elbows

Installation	Inlet section	Outlet section
(A) Single pipe elbow	min. $20 \times DN$	min. $5 \times DN$
(B) S-shaped pipe elbow	min. $25 \times DN$	min. $5 \times DN$
(C) Three-dimensional pipe elbow	min. $40 \times DN$	min. $5 \times DN$

Avoiding cavitation

To avoid cavitation, a static overpressure is required downstream of the flowmeter (downstream pressure). This can be estimated using the following formula:

$$p_1 \geq 1,3 \times p_2 + 2,6 \times \Delta p'$$

- p_1 Static gauge pressure downstream of the device (mbar)
- p_2 Steam pressure of fluid at operating temperature (mbar)
- $\Delta p'$ Pressure drop, measuring medium (mbar)

Installation at high measuring medium temperatures

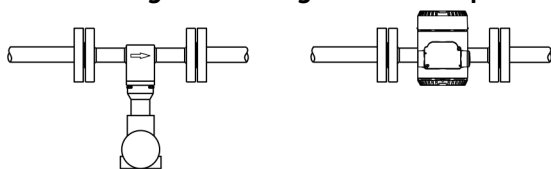
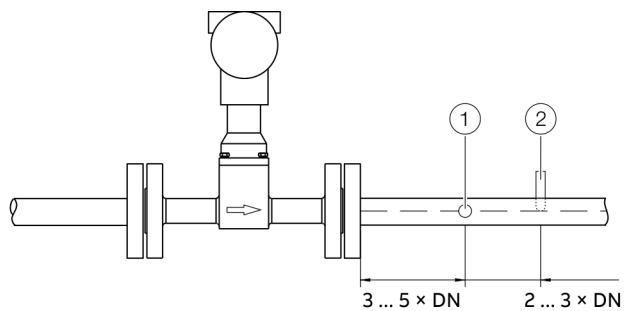

Figure 21: Installation at high measuring medium temperatures

At high measuring medium temperatures > 150 °C (> 302 °F), the sensor must be installed so that the transmitter is pointing to the side or downward.

Installation for external pressure and temperature measurement



- ① Pressure measuring point
- ② Temperature measuring point

Figure 22: Arrangement of the temperature and pressure measuring points

As an option, the flowmeter can be fitted with a Pt100 for direct temperature measurement. This temperature measurement enables, for example, the monitoring of the measuring medium temperature or the direct measurement of saturated steam in mass flow units.

If pressure and temperature are to be compensated externally (e.g. using the flow computer unit), the measuring points must be installed as illustrated.

Installation of setting equipment

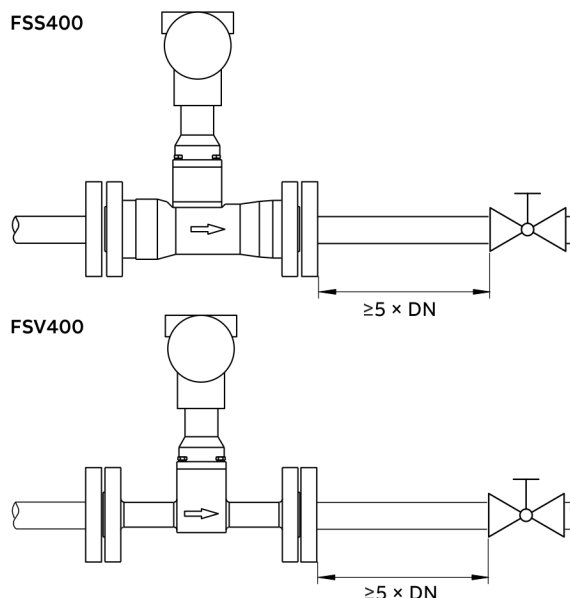

Figure 23: Installation of setting devices

Control and setting devices should be arranged in the forward flow direction **downstream** from the flowmeter at a distance of at least 5 × DN.

If the measuring medium is conveyed through piston pumps / plunger pumps or compressors (pressures for fluids > 10 bar [> 145 psi]), it may be subject to hydraulic vibration in the piping when the valve is closed.

If this case, it is essential that the valve be installed in the forward flow direction **upstream** from the flowmeter. Suitable dampers (for example, air vessels in the case of pumping using a compressor) might need to be used.

The **SwirlMaster FSS400** is particularly well suited for such arrangements.

... 6 Installation

... Installation conditions

Flowmeter sensor insulation recommendation

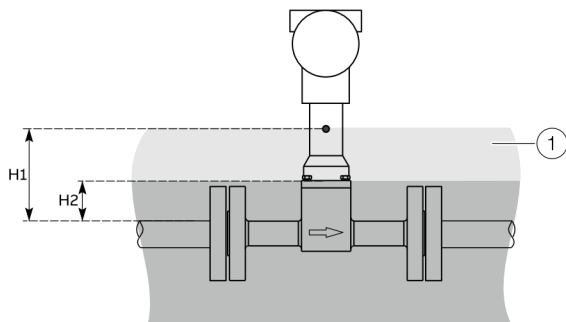

① Insulation

H1 Maximum insulation thickness at $T_{\text{medium}} \leq 150 \text{ °C}$ (302 °F)

H2 Maximum insulation thickness at $T_{\text{medium}} \leq 250 \text{ °C}$ (482 °F)

Figure 24: Insulation of the meter tube

NOTICE

Overheating of the transmitter

Insulating above the sensor neck can lead to overheating of the transmitter or ingress of moisture into the transmitter.

- Even with correct insulation, overheating of the transmitter can occur if the ambient temperature at the installation location of the transmitter in combination with a high medium temperature creates extreme conditions.
- The operator must observe the ambient conditions and ensure that measures are taken to avoid overheating of the transmitter components. The actual electronic temperature can be observed in the 'Diagnostics Menu' in the device and must not exceed 85 °C (185 °F).

Use of heat tracing

Trace heating may be used under the following conditions:

- If it is installed directly on or around the piping
- If, in the case of existing pipeline insulation, it is installed inside the insulation (the maximum thickness shown in **Figure 24** must not be exceeded).
- If the maximum temperature the heat tracing is able to produce is less than or equal to the maximum medium temperature.

Note

Installation requirements in accordance with EN 60079-14 must be observed.

Please note that the use of trace heaters will not impair EMC protection or generate additional vibrations.

Ambient conditions

Ambient temperature

In accordance with IEC 60068-2-78

Explosion protection	Ambient temperature range T_{amb}	
	Standard	Advanced mode
No explosion protection	-20 to 85 °C* (-4 to 185 °F)*	-40 to 85 °C* (-40 to 185 °F)*
Ex ia, Ex ec	-20 °C < T_a < xx °C** (-4 °F < T_a < xx °F)**	-40 °C < T_a < xx °C** (-40 °F < T_a < xx °F)**
Ex d ia, XP-IS	-20 to 75 °C (-4 to 167 °F)	-40 to 75 °C (-40 to 167 °F)
IS, NI	-20 °C < T_a < xx °C** (-4 °F < T_a < xx °F)**	-40 °C < T_a < xx °C** (-40 °F < T_a < xx °F)**

* Remote mount design: max. 80 °C (176 °F) ambient temperature due to the factory-fitted signal cable!

** The temperature xx °C (xx °F) depends on the temperature class T_{class}

Relative humidity

Design	Relative humidity
Standard	Up to 100 % with admissible condensation

Measuring medium temperature range

Design	T_{medium}
Standard	-55 to 280 °C (-67 to 536 °F)
High-temperature version (option)	-55 to 350 °C (-67 to 662 °F)

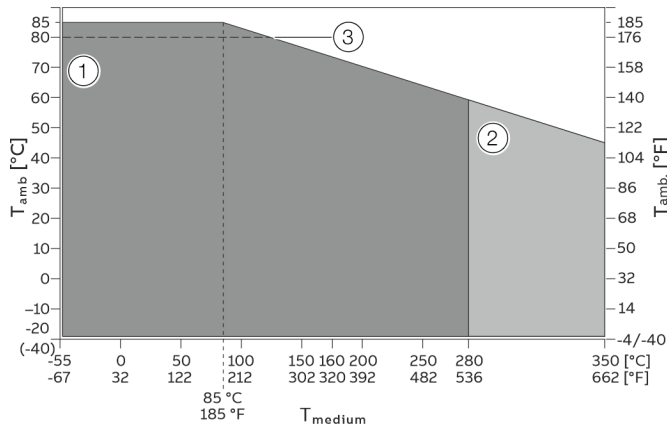

- ① Temperature range standard version
- ② Temperature range high-temperature version (option)
- ③ Remote mount design: max. 80 °C (176 °F) ambient temperature due to the factory-fitted signal cable!

Figure 25: Measuring medium temperature T_{medium} dependent on the ambient temperature T_{amb} .

Pressure Equipment Directive

Conformity assessment in accordance with Category III, fluid group 1, gas.

Note the corrosion resistance of the meter tube materials in relation to the measuring medium.

Material fatigue in pipe components

A maximum of 1000 load changes at $\Delta p = PS$ and any number of load changes at $\Delta p = PS/10$ are permissible.

CRN approval

Certain device versions and connection options have CRN approval under number 'CRN 0F1209.xx'.

Please contact ABB for more information.

... 6 Installation

Material load

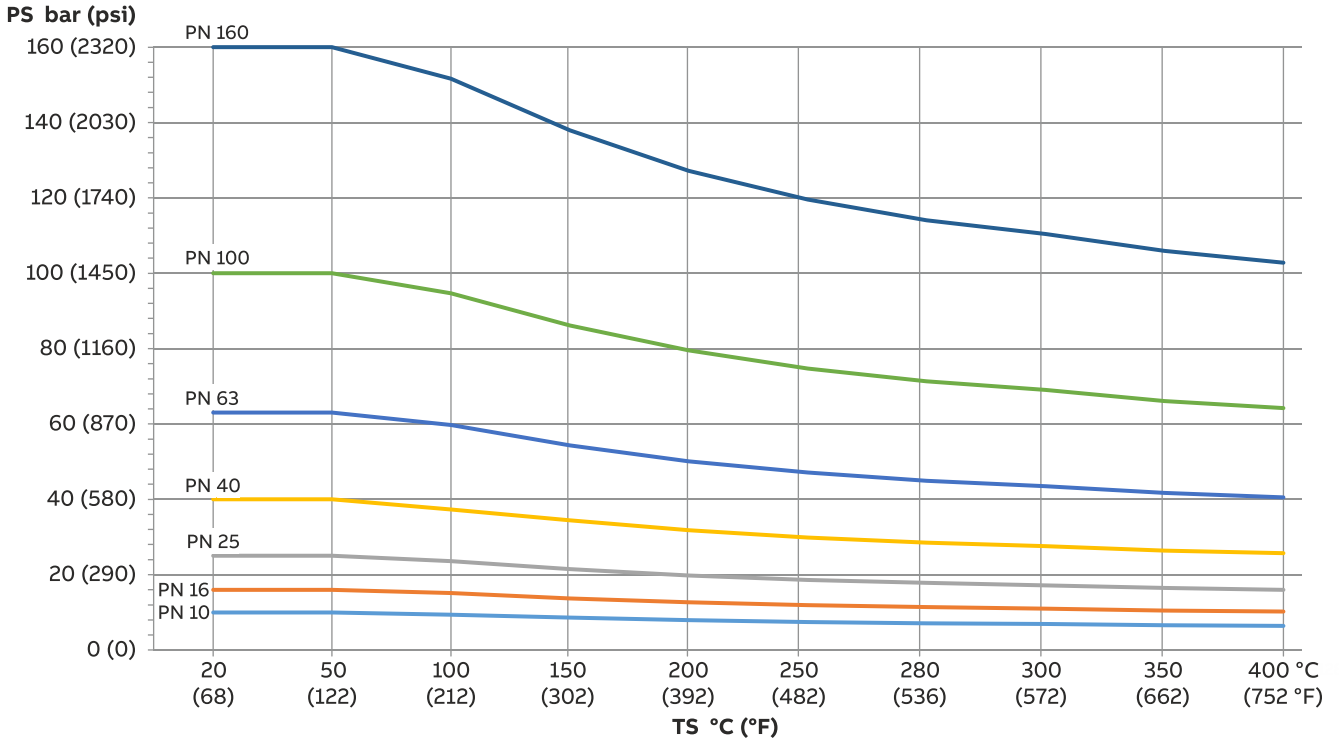

Figure 26: DIN flange process connection

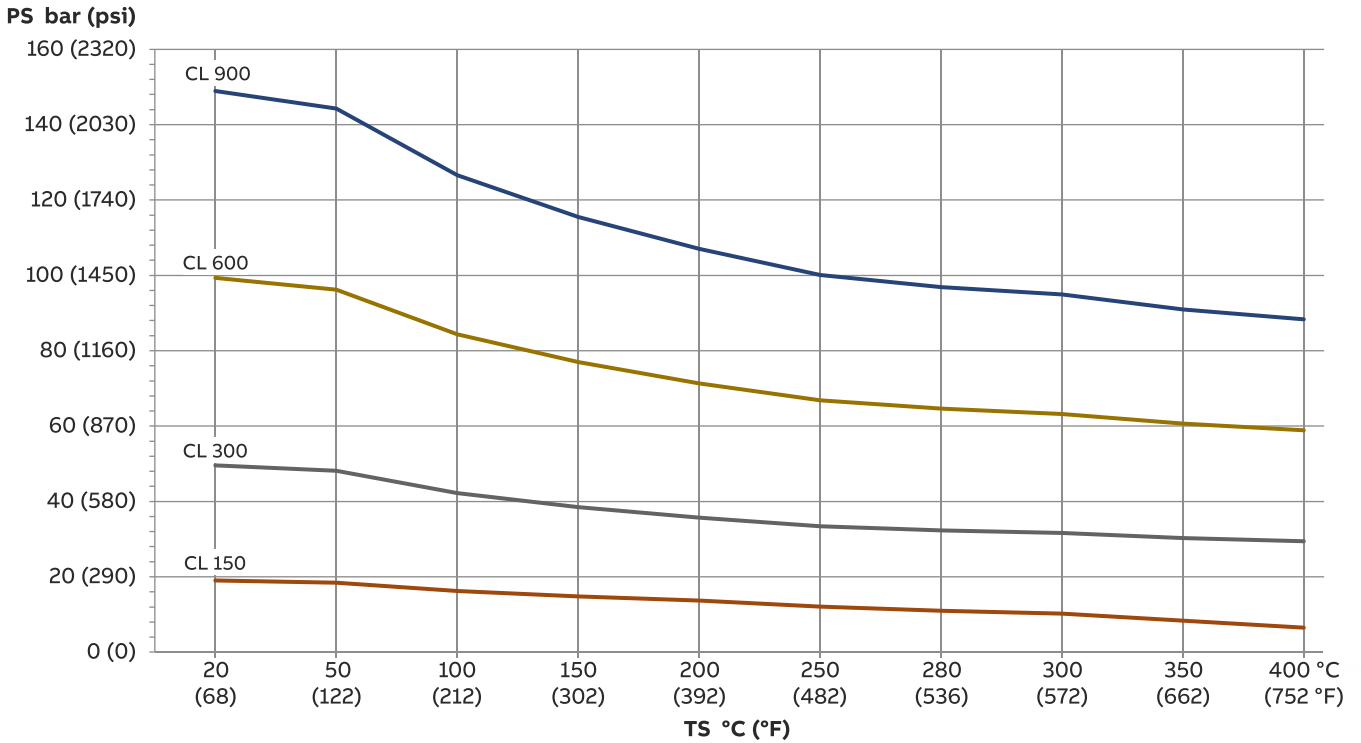

Figure 27: ASME flange process connection

Installing the sensor

Observe the following points during installation:

- For devices with a remote mount design, make sure that the sensor and transmitter are assigned correctly.
- The flow direction must correspond to the marking, if present
- The maximum torque must be observed for all flanged connections.
- The devices must be installed without mechanical tension (torsion, bending)
- Wafer type devices with plane parallel counterflanges should be installed with suited gaskets only.
- Use gaskets made from a material that is compatible with the measuring medium and measuring medium temperature.
- The piping may not exert any inadmissible forces or torques on the device.
- Do not remove the sealing plugs in the cable glands until you are ready to install the electric lines.
- Make sure the gaskets for the housing cover are seated correctly. Carefully seal the cover. Tighten the cover fittings
- Do not expose the transmitter to direct sunlight and provide for appropriate sun protection where necessary
- When selecting the installation location, make sure that moisture cannot penetrate into the terminal box or the transmitter housing

Installation of the flowmeter

The device can be installed at any location in a pipeline under consideration of the installation conditions.

1. Position the meter tube coplanar and centered between the piping.
2. Install gaskets between the sealing surfaces.

Note

- To achieve the best results, make sure that the gaskets and meter tube fit concentrically.
 - To guarantee that the flow profile is not distorted, the gaskets must not protrude into the piping.
3. Use the appropriate screws for the holes.
 4. Slightly grease the threaded nuts.
 5. Tighten the nuts in a crosswise manner as shown in the figure. First tighten the nuts to approx. 50 % of the maximum torque, then to approx. 80 %, and finally a third time to the maximum torque.

Note

Torques for screws depend on temperature, pressure, screw and gasket materials. The relevant applicable regulations must be taken into consideration.

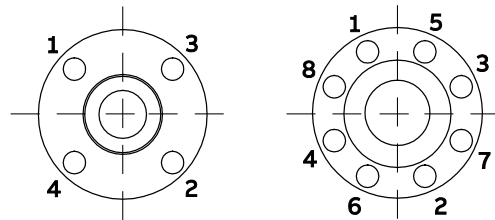

Figure 28: Tightening sequence for the flange screws

... 6 Installation

... Installing the sensor

Centering the wafer type design

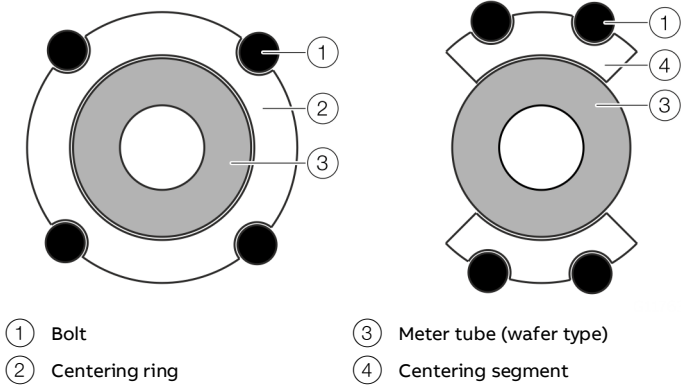

Figure 29: Centering the wafer type design with the ring or segment

Wafer type devices (FV400 only) are centered via the outside diameter of the flowmeter sensor body with the corresponding bolts.

Depending on the nominal pressure rating, sleeves for the bolts, a centering ring up to DN 80 (3 in) or centering segments can be ordered as additional accessories.

Opening and closing the housing

⚠ DANGER

Danger of explosion if the device is operated with the transmitter housing or terminal box open!

Before opening the transmitter housing or the terminal box, note the following points:

- Check that a valid fire permit is available.
- Make sure that there is no explosion hazard.
- Before opening the device, switch off the power supply and wait for $t > 2$ minutes.

⚠ WARNING

Risk of injury due to live parts.

Improper work on the electrical connections can result in electric shock.

- Connect the device only with the power supply switched off.
- Observe the applicable standards and regulations for the electrical connection.

NOTE

Potential adverse effect on the IP rating

- Check the O-ring gasket for damage and replace it if necessary before closing the housing cover.
- Check that the O-ring gasket is properly seated when closing the housing cover.

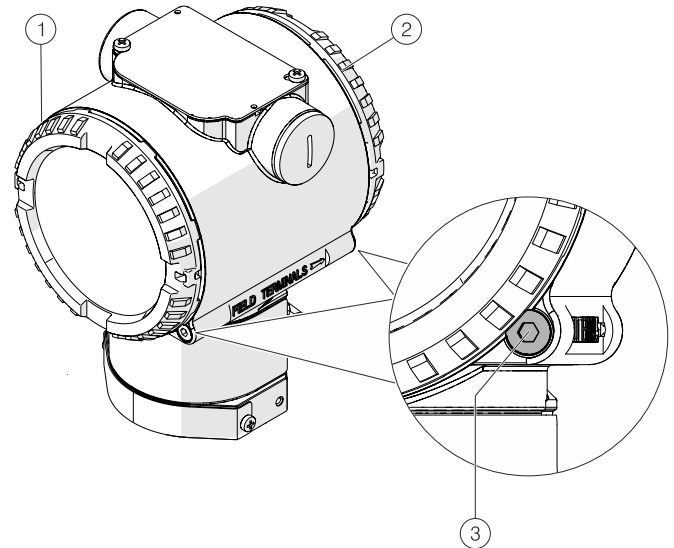

Figure 30: Cover lock (example)

- ① Housing cover (electronic / LCD indicator)
- ② Housing cover (terminal compartment)
- ③ Cover lock screw

Open the housing:

1. Release the cover lock by screwing in the cover lock screw ③.
2. Unscrew cover ① or ②.

Close the housing:

1. Screw on the cover ① or ②.
2. After closing the housing, lock the cover by unscrewing the cover lock screw ③.

Note

After several weeks, increased force will be required to unscrew the housing cover.

This is not caused by the threads, but instead is due to the type of gasket.

Note

For LCD indicators with TTG (Through-The-Glass) operation via capacitive buttons, the device should be repowered after closing the transmitter housing cover. Thus, the button sensitivity is calibrated, and an optimum button function is ensured.

Adjusting the transmitter position**Rotating the transmitter housing****⚠ DANGER****Explosion hazard**

When the screws for the transmitter housing are loosened, the explosion protection is suspended.

- Tighten all the screws of the transmitter housing prior to commissioning.

NOTE**Damage to components!**

- The transmitter housing must not be lifted without pulling out the cable, otherwise the cable can tear off
- The transmitter housing must not be rotated more than 360 degrees.

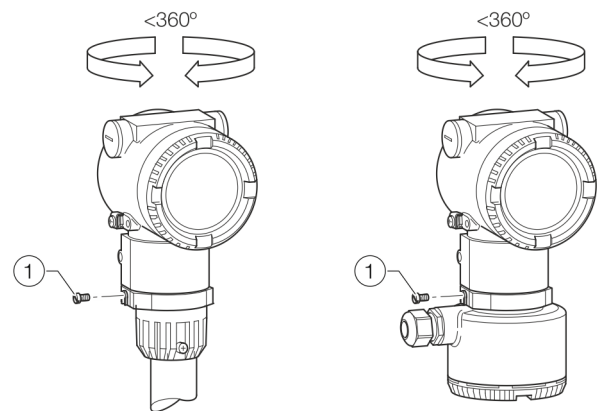

① Locking screw

Figure 31: Rotating the transmitter housing

1. Loosen the stop screw on the transmitter housing using a 4 mm Allen key.
2. Rotate the transmitter housing in the direction required.
3. Tighten the locking screw.

... 6 Installation

... Adjusting the transmitter position

Rotating the LCD indicator

⚠ WARNING

Risk of injury due to live parts!

When the housing is open, contact protection is not provided and EMC protection is limited.

- Before opening the housing, switch off the power supply.

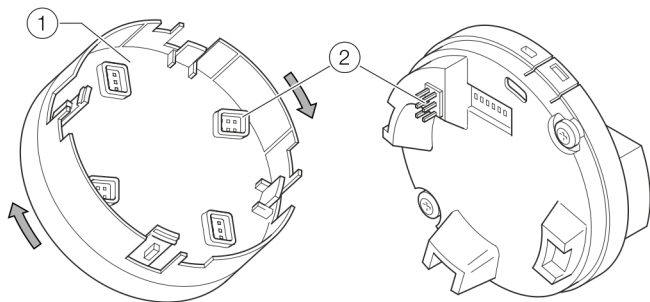

① LCD indicator

② Plug-in connector

Figure 32: Rotating the LCD indicator

The LCD indicator can be rotated in 90° increments to make it easier to read and operate.

1. Unscrew the front housing cover.
2. Pull out the LCD indicator and place it in the desired position.
3. Tighten the front housing cover hand-tight.

NOTE

Potential adverse effect on the IP rating!

If the O-ring gasket is seated incorrectly or is damaged, this may have an adverse effect on the IP rating.

- Check that the O-ring gasket is properly seated when closing the housing cover.

7 Electrical connections

Safety instructions

⚠ WARNING

Risk of injury due to live parts.

Improper work on the electrical connections can result in electric shock.

- Connect the device only with the power supply switched off.
- Observe the applicable standards and regulations for the electrical connection.

Note

When using the device in potentially explosive atmospheres, note the additional connection data in **Use in potentially explosive atmospheres** on page 7!

The electrical connection may only be established by authorized specialist personnel and in accordance with the connection diagrams.

The electrical connection information in this manual must be observed; otherwise, the IP rating may be adversely affected. Ground the measurement system according to requirements.

Installing the connection cables

Ensure that a drip loop (water trap) is used when installing the connecting cables for the sensor.

When mounting the sensor vertically, position the cable entries at the bottom.

If necessary, rotate the transmitter housing accordingly.

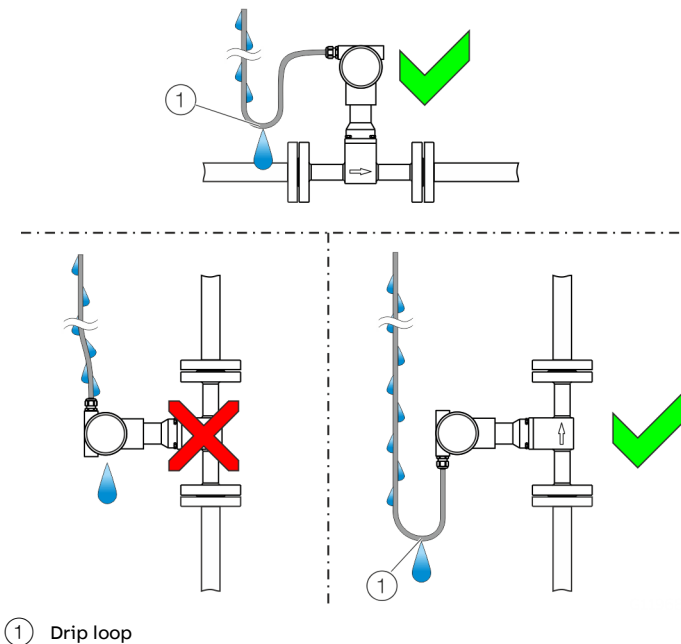

Figure 33: Laying the connection cable

Cable glands

The electrical connection is made using cable entries with a $\frac{1}{2}$ in NPT or M20 \times 1.5 thread.

Devices with an M20 \times 1.5 thread

Devices with an M20 \times 1.5 thread are supplied with factory-installed cable glands and sealing plugs.

Devices with a $\frac{1}{2}$ in NPT thread

The supplied transport sealing plugs do not have IP rating 4X / IP 67 and are not approved for use in potentially explosive atmospheres.

The transport sealing plugs must be replaced with suitable cable glands or sealing plugs during device installation.

When selecting the cable glands or sealing plugs, make sure they have the required IP rating and explosion protection!

To guarantee IP rating 4X / IP67, the cable glands / sealing plugs must be screwed in using a suited sealing compound.

Grounding

NOTICE

Impact on measurement

The measurement may be impacted by external electric disruptions (EMC disruptions).

- Ground the device as shown to avoid impact on the measurement by external electric disruptions (EMC disruptions)

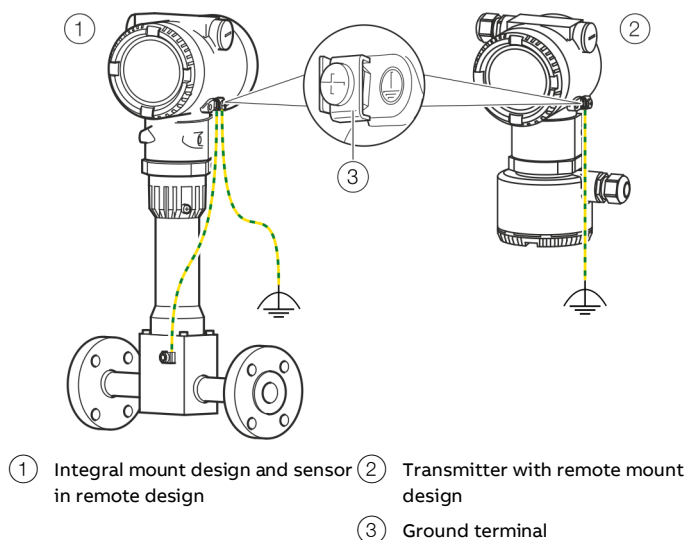

Figure 34: Ground terminals

For the earthing (PE) of the transmitter or the connection of a protective earth, a connection is available both on the exterior of the housing and in the connection space. Both connections must be galvanically connected to one another.

To avoid potential differences, a 3-point grounding as shown in Figure 34 is recommended.

These connection points can be used if grounding or the connection of a protective conductor is prescribed by national regulations for the selected type of supply or the type of protection used.

1. Loosen the screw terminal on the transmitter housing or on the housing of the VortexMaster / SwirlMaster.
2. Insert the forked cable lug for functional grounding between the two metal tabs and into the loosened terminal.
3. Tighten the screw terminal.

... 7 Electrical connections

Connecting inputs, outputs and digital communication

For detailed information on the connection options and fieldbus interfaces, please refer to the relevant chapters:

- **Devices with HART® communication** from page 49 onwards,
- **Devices with Ethernet-APL™ communication** from page 55 onwards,
- **Devices with Modbus RTU® communication** from page 57 onwards,
- **Devices with PROFIBUS PA® or FOUNDATION-Fieldbus® communication** from page 59 onwards,

Connection to remote mount design

NOTE

Impairment of the device function

Impairment of the device function due to incorrect allocation of sensor and transmitter.

Correct allocation can be identified via the serial number on the name plate.

- Make sure that the sensor and transmitter are correctly allocated.

Cable specification

For devices with a remote mount design, the transmitter and sensor are connected using a signal cable.

The signal cable used must meet at least the following technical specification.

Cable specification	
Impedance	70 to 120 Ω
Withstand voltage	500 V
Outer diameter	6 to 12 mm (0.24 to 0.47 in)
Cable design	3×2×0.75 mm ² , twisted pair
Conductor cross-section	0.75 mm ²
Shield	Copper braid with approximately 85 % coverage
Temperature range	Application-dependent, for use in potentially explosive atmospheres, observe the information in Temperature resistance for the connecting cable on page 9!
Maximum signal cable length	30 m (98 ft)

Recommended cables

It is recommended to use an ABB signal cable for standard applications.

The ABB signal cable fulfills the above-mentioned cable specification and can be utilized unrestrictedly up to an ambient temperature of T_{amb.} = 80 °C (176 °F).

ABB signal cable	Ordering number
5 m (16 ft), standard scope of delivery	3KXF065068U0200
10 m (33 ft)	3KXF065068U0300
20 m (65 ft)	3KXF065068U0400
30 m (98 ft)	3KXF065068U0500

Installing the signal cable

The signal cable connects the measuring sensor to the transmitter. The cable is fixed to the transmitter, however, it can be separated as needed.

When laying the signal cable, observe the following points:

- Install the signal cable in the shortest path between the measuring sensor and the transmitter. Shorten the signal cable accordingly as needed.
- The maximum permissible signal cable length is 30 m (99 ft).
- Avoid installing the signal cable in the vicinity of electric equipment or switching elements that can create stray fields, switching pulses and magnetic induction. If this is not possible, run the signal cable through a metal pipe and connect this to operational ground.
- Carry out all terminal connections carefully.
- Lay the wires in the terminal box in such a way that they are not affected by vibrations.

Producing a signal cable

The signal cable is available in four standard lengths: 5 m (16.4 ft), 10 m (32.8 ft), 20 m (65.6 ft) and 30 m (98.4 ft).

The cable ends are already prepared for installation.

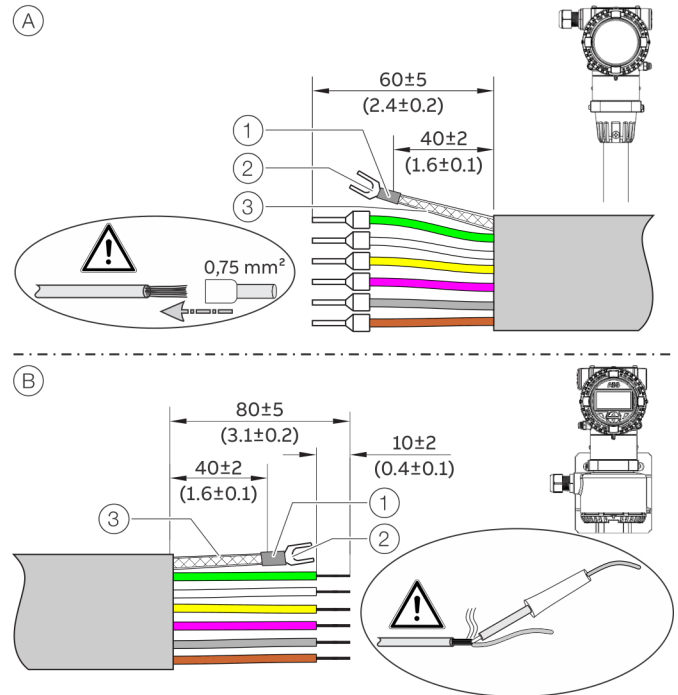

- | | | | |
|---|------------------------------------|---|---|
| Ⓐ | Sensor | Ⓐ | Fork cable lug |
| Ⓑ | Transmitter | Ⓑ | Heat-shrink tube Ø 2.3 mm, 40 mm long (shielding) |
| ① | Heat-shrink tube Ø 4mm, 10 mm long | ① | |
| ② | | ② | |
| ③ | | ③ | |

Figure 35: Signal cable, dimensions in mm (in)

The signal cable can also be cut to any length. Then the cable ends must be prepared as shown in Figure 35.

- Twist the shield, shorten and insulate with heat-shrink tube ③. Crimp a matching forked cable lug ② and insulate the crimping with a heat-shrink tube ①.
- Attach wire-end ferrules (0.75 mm²) to the wires on the sensor side.
- Twist the wires on the transmitter side and solder.

... 7 Electrical connections

... Connection to remote mount design

Connecting the signal cable

⚠ DANGER

Danger of explosion if the device is operated with the transmitter housing or terminal box open!

Before opening the transmitter housing or the terminal box, note the following points:

- A valid fire permit must be present.
- Make sure that there is no explosion hazard.
- Switch off the power supply and wait for $t > 2$ minutes before opening.

1. Use the signal cable connected to the transmitter to make the electrical connection between the measuring sensor and the transmitter.
2. Unscrew the cover of the terminal boxes on the transmitter and the measuring sensor.
3. Produce the signal cable in accordance with the specification (see **Figure 35**).
4. Insert the cable through the cable gland into the terminal box.
5. Tighten the cable gland.
6. Connect the wires to the corresponding terminals (see **Figure 36**).
7. Connect the shield of the signal cable to the forked cable lug to the ground terminal.
8. Screw on the cover of the terminal compartment on the transmitter and the measuring sensor and tighten by hand. Make sure the gaskets for the cover are seated properly.

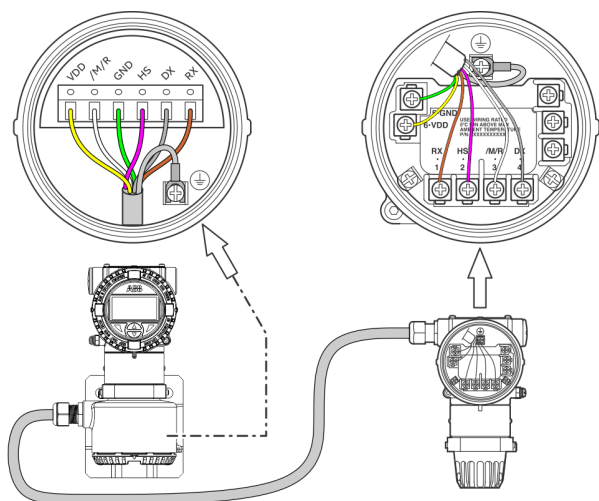



Figure 36: Electrical connection

Terminal	Color / function
VDD	Yellow
/M/R	White
GND	Green
HS	Pink
DX	Grey
RX	Brown
	Ground terminal (functional ground / shield)

Note

The shielding of the signal cable also serves as a functional ground and must be connected to the sensor and to the transmitter on both sides.

8 Digital communication

Digital output – Electrical data

Not active in devices with FOUNDATION Fieldbus® communication!

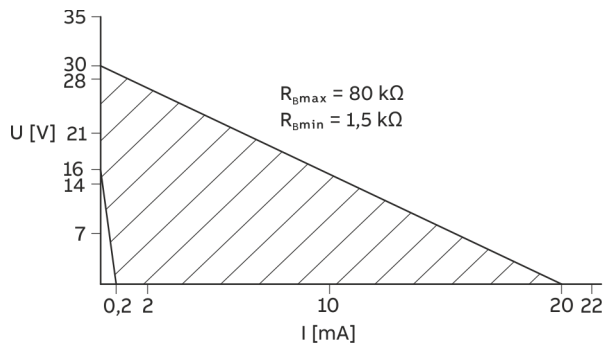

Figure 37: Range of the external supply voltage and current

Digital output	
Operating voltage	16 to 30 V DC
Output current	maximum 20 mA
External resistance R_B	$1.5 \text{ k}\Omega \leq R_B \leq 80 \text{ k}\Omega$
Output 'closed'	$0 \text{ V} \leq U_{\text{low}} \leq 2 \text{ V}$ $2 \text{ mA} \leq I_{\text{low}} \leq 20 \text{ mA}$
Output 'open'	$16 \text{ V} \leq U_{\text{high}} \leq 30 \text{ V}$ $0 \text{ mA} \leq I_{\text{high}} \leq 0.2 \text{ mA}$
Pulse output	f_{max} : 10 kHz Pulse width: 0.05 to 2000 ms
Frequency output	f_{max} : 10.5 kHz
Output functions (configurable)	Frequency output Pulse output Binary output (in / out, e.g. alarm signal)

Devices with HART® communication

Note

The HART® protocol is an unsecured protocol (in terms of IT and cyber security), as such the intended application should be assessed to ensure that this protocol is suitable before implementation.

Current output / HART output

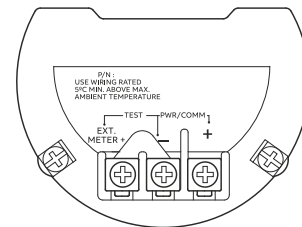

Figure 38: Terminals FSx430 (without binary output)

Terminal	Function / comment
PWR/COMM +	Power supply, current
PWR/COMM -	output- / HART output
EXT. METER	Not assigned

Current output / HART output, digital output and analog input

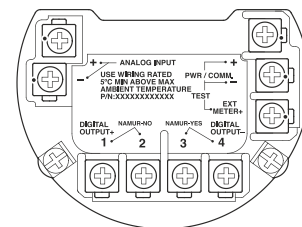

Figure 39: Terminals FSx450 or FSx430 with binary output

Terminal	Function / comment
PWR/COMM +	Power supply, current output / HART output
PWR/COMM -	
EXT. METER +	Current output 4 to 20 mA for external display
DIGITAL OUTPUT 1+	Digital output, positive pole
DIGITAL OUTPUT 2	Bridge after terminal 1+, NAMUR output deactivated
DIGITAL OUTPUT 3	Bridge after terminal 4-, NAMUR output activated
DIGITAL OUTPUT 4-	Digital output, negative pole
ANALOG INPUT +	Analog input 4 to 20 mA for remote transmitter, e.g.
ANALOG INPUT -	for temperature, pressure, etc.

... 8 Digital communication

... Devices with HART® communication

Power supply

Devices with HART® communication	
Terminals	PWR/COMM + / PWR/COMM -
Supply voltage	12 to 42 V DC
	13.6 to 42 V DC (With Surge protection – order code S1)
	14.2 to 42 V DC (With SIL and/or enhanced EMC protection – order code G4)
Residual ripple	Maximum 5 % or $U_{SS} = \pm 1.5$ V
Power consumption	< 1 W
U_{SS}	Peak-to-peak value of voltage

Digital output

For electric data of the digital output, see **Digital output – Electrical data** on page 49.

Current output / HART output

Only for devices with HART communication.

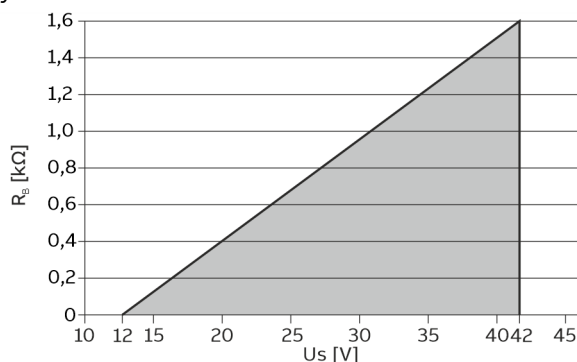
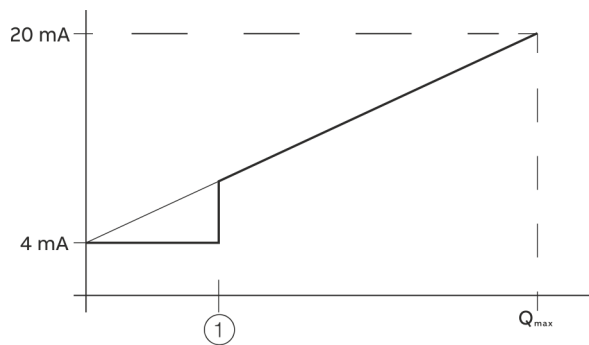

Figure 40: Load diagram of current output; load depending on supply voltage

Devices with HART® communication	
Terminals	PWR/COMM + / PWR/COMM -
Minimal Load R_B	250 Ω
The load R_B is calculated as a function of the available supply voltage U_S and the selected signal current I_B as follows:	
$R_B = U_S / I_B$	
R_B	Load resistance
U_S	Supply voltage
I_B	Signalstrom

Low flow cut-off



① Low flow

Figure 41: Behavior of the current output

The current output behaves as shown in the figure. Above the low flow, the current curve proceeds as a straight line in accordance with the flow rate.

- Flow rate = 0, current output = 4 mA
- Flow rate = Q_{max} , current output = 20 mA

If the low flow cut-off is activated, flow rates below the low flow are set to 0 and the current output set to 4 mA.

Analog input 4 to 20 mA

Only for devices with HART® communication.

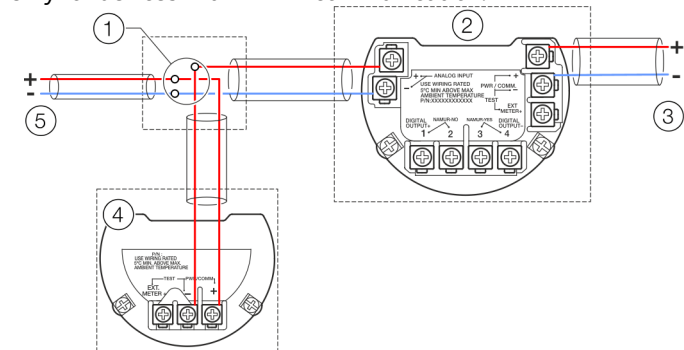

- ① Terminal points in separate cable junction box
- ② SwirlMaster FSS400, VortexMaster FSV400
- ③ Power supply SwirlMaster FSS400, VortexMaster FSV400
- ④ Remote transmitter
- ⑤ Power supply for the remote transmitter

Figure 42: Connection of transmitters to analog input (example)

Analog input 4 to 20 mA

Terminals	ANALOG INPUT+ / ANALOG INPUT-
Operating voltage	16 to 30 V DC
Input current	3.8 to 20.5 mA
Equivalent resistance	90 Ω

A remote transmitter with current output from 4 to 20 mA can be connected to the analog input:

- Pressure transmitter e.g. ABB model 261 / 266
- Temperature transmitter
- Gas analyzer for the net methane content of biogas
- Density meter or mass meter for a density signal

The analog input can be configured using the relevant software:

- Input for the pressure measurement for pressure compensation for the flow measurement of gases and vapor.
- Input for the return temperature measurement for energy measurement.
- Input for the net methane content of biogas.
- Input for density measurement for the calculation of the mass flow.

HART® communication with remote transmitter

Only for devices with HART® communication.

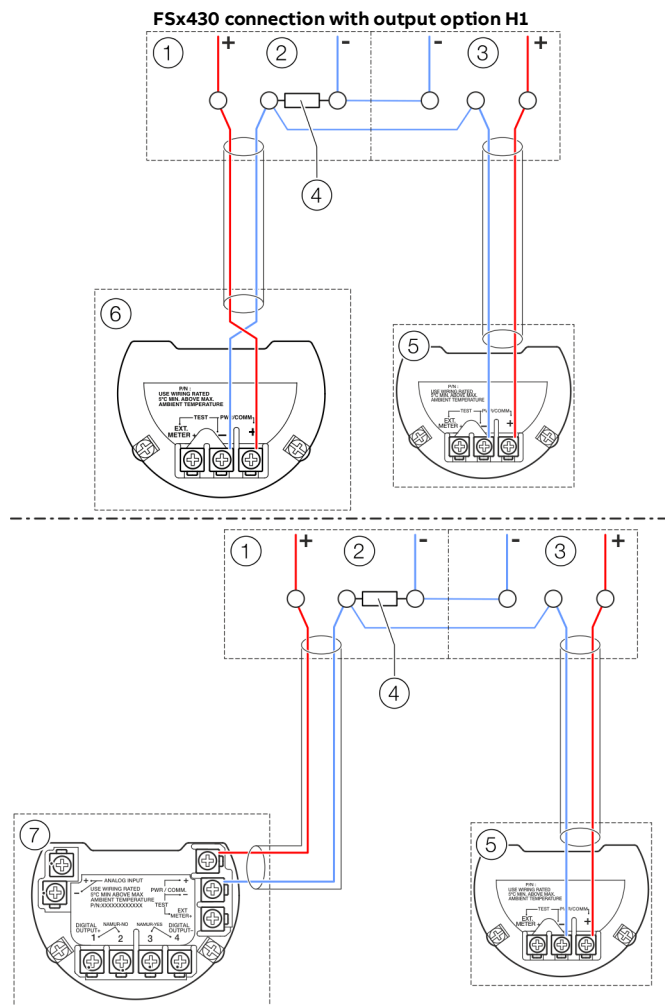

G11773-01

FSx450 or FSx430 connection with output option H5

- ① Control cabinet
- ② Power supply
- ③ Power supply for the remote transmitter
- ④ Load resistance
- ⑤ External pressure transmitter
- ⑥ FSx430 connection with output option H1
- ⑦ FSx450 or FSx430 connection with output option H5

Figure 43: Connection of transmitters with HART communication (example)

... 8 Digital communication

... Devices with HART® communication

A remote pressure transmitter with HART communication can be connected through the current output / HART output (4 to 20 mA). Here, the remote transmitter must be operated in HART Burst mode, e.g. the ABB pressure transmitter model 266 or model 261 with the 'P6 – HART Burst Mode' ordering option. The SwirlMaster FSS400, VortexMaster FSV400 transmitter supports HART communication up to the HART7 protocol.

Note

The VortexMaster / SwirlMaster cannot communicate with a control system or configuration tool via HART while the pressure transmitter is communicating in BURST mode, because the BURST signal has priority over cyclical HART communication.

HART® communication connection example

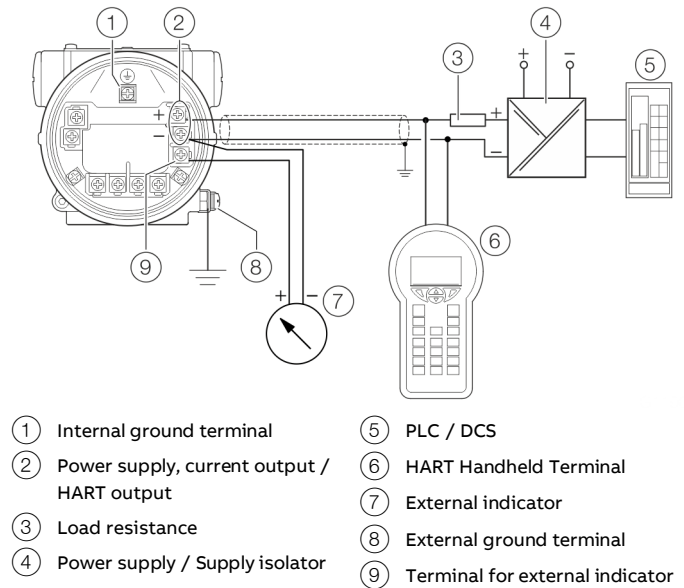

Figure 44: HART communication (example)

For connecting the signal voltage / supply voltage, twisted cables with a conductor cross-section of 18 to 22 AWG / 0.8 to 0.35 mm² and a maximum length of 1500 m (4921 ft) must be used. For longer leads a greater cable cross section is required.

For shielded cables the cable shielding must only be placed on one side (not on both sides).

For the earthing on the transmitter, the inner terminal with the corresponding marking can also be used.

The output signal (4 to 20 mA) and the power supply are conducted via the same conductor pair.

The transmitter works with a supply voltage between 12 and 42 V DC. For devices with the type of protection 'Ex ia, intrinsic safety' (FM, CSA, and SAA approval), the supply voltage must not exceed 30 V DC. In some countries the maximum supply voltage is limited to lower values. The permissible supply voltage is specified on the name plate on the top of the transmitter.

NOTICE

Any configuration changes are saved in sensor memory only if no HART communication is taking place.

- To securely save any changes, make sure that HART communication has ended before the device is disconnected from power.

The possible lead length depends on the total capacity and the total resistance and can be estimated based on the following formula.

$$L = \frac{65 \times 106}{R \times C} - \frac{C_i + 10000}{C}$$

L Lead length is meters

R Total resistance in Ω

C Lead capacity

C_i Maximum internal capacity in pF of the HART field devices in the circuit

Avoid installing the cable together with other power leads (with inductive load, etc.), as well as the vicinity to large electrical installations.

The HART Handheld terminal can be connected to any connection point in the circuit if a resistance of at least 250 Ω is present in the circuit. If there is resistance of less than 250 Ω, an additional resistor must be provided to enable communication. The handheld terminal is connected between the resistor and transmitter, not between the resistor and the power supply.

Eliminating HART® communication faults

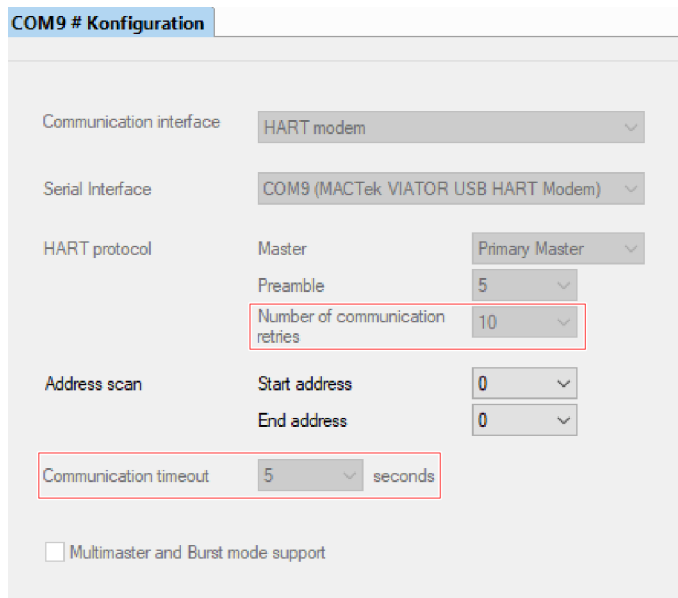

Figure 45: Adjusting the communication parameters

If any disruptions in communication with the DTM should appear, we recommend adjusting the communication parameters to stabilize the HART® communication.

Parameter	Recommended settings
Number of communication retries (number of communication attempts)	Maximum possible amount
Communication timeout (time out period)	Maximum possible time

... 8 Digital communication

... Devices with HART® communication

Factory settings of HART® Variables PV, SV, TV and QV depending on the operating mode

The following table shows the factory default assignment of process variables to the HART variables (PV, SV, TV or Qv) depending on operating mode.

Operating mode	HART variables			
	PV	SV	TV	QV
Liquid Volume	Operating volumes	Temperature	Totalizer volumes	–
Liquid Mass	Mass	Temperature	Totalizer mass	Operating volumes
Gas Act. Volume	Operating volumes	Temperature	Totalizer volumes	–
Gas Std./Norm Vol.	Standard volume	Temperature	Standard volume counter	Operating volumes
Gas Mass	Mass	Temperature	Totalizer mass	Operating volumes
Steam Act. Volume	Operating volumes	Temperature	Totalizer volumes	–
Steam/Water Mass	Mass	Temperature	Totalizer mass	Operating volumes
Steam/Water Energy	Energy	Temperature	Energy counter	Mass

Possible selection of HART® Variables depending on the respective operating mode

The following table shows the possible process variables which can be assigned to the HART variables (PV, SV, TV or Qv) depending on the operating mode. The process variables can be assigned to the HART variables via the Device Type Manager or the EDD / FDI package in the Field Information Manager (FIM).

Operating mode	PV	Additional dynamic HART variables which can be selected							
		Temperature	Totalizer volumes	–	–	–	–	–	–
Liquid Volume	Operating volumes	Temperature	Totalizer volumes	–	–	–	–	–	–
Liquid Mass	Mass	Temperature	Totalizer mass	Operating volumes	Totalizer volumes	–	–	–	–
Gas Act. Volume	Operating volumes	Temperature	Totalizer volumes	–	–	–	–	–	–
Gas Std./Norm Vol.	Standard volume	Temperature	Standard volume counter	Operating volumes	Totalizer volumes	–	–	–	–
Gas Mass	Mass	Temperature	Totalizer mass	Operating volumes	Totalizer volumes	–	–	–	–
Steam Act. Volume	Operating volumes	Temperature	Totalizer volumes	–	–	–	–	–	–
Steam/Water Mass	Mass	Temperature	Totalizer mass	Operating volumes	Totalizer volumes	–	–	–	–
Steam/Water Energy	Energy	Temperature	Energy counter	Operating volumes	Totalizer volumes	Mass	Totalizer mass	–	–

Devices with Ethernet-APL™ communication

Note

The Ethernet-APL™ protocol is an unsecured protocol (in terms of IT or cyber security), as such the intended application should be assessed to ensure that this protocol is suitable before implementation.

Note

For detailed information on the Ethernet-APL™ interface, please refer to the separate interface description 'COM/FSS400/FSV400/ETHERNET-APL'.

Terminal layout

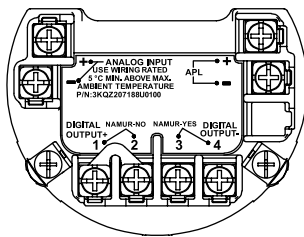

Figure 46: Terminals

Terminal	Function / comment
APL+	Power supply, Ethernet-APL interface
APL-	
DIGITAL OUTPUT 1+	Digital output, positive pole
DIGITAL OUTPUT 2	Bridge after terminal 1+, NAMUR output deactivated
DIGITAL OUTPUT 3	Bridge after terminal 4-, NAMUR output activated
DIGITAL OUTPUT 4-	Digital output, negative pole
ANALOG INPUT +	FSS450, FSV450 only!
ANALOG INPUT -	Analog input 4 to 20 mA for remote transmitter, e.g. for temperature, pressure, etc.

Power supply

Connection values of APL field switch

Devices with Ethernet-APL communication

Terminals	APL + / APL -
Supply voltage	9 to 15 V DC
Power consumption	0.54 W

Digital output

For electric data of the digital output, see **Digital output – Electrical data** on page 49.

... 8 Digital communication

... Devices with Ethernet-APL™ communication

Ethernet-APL™ network topology

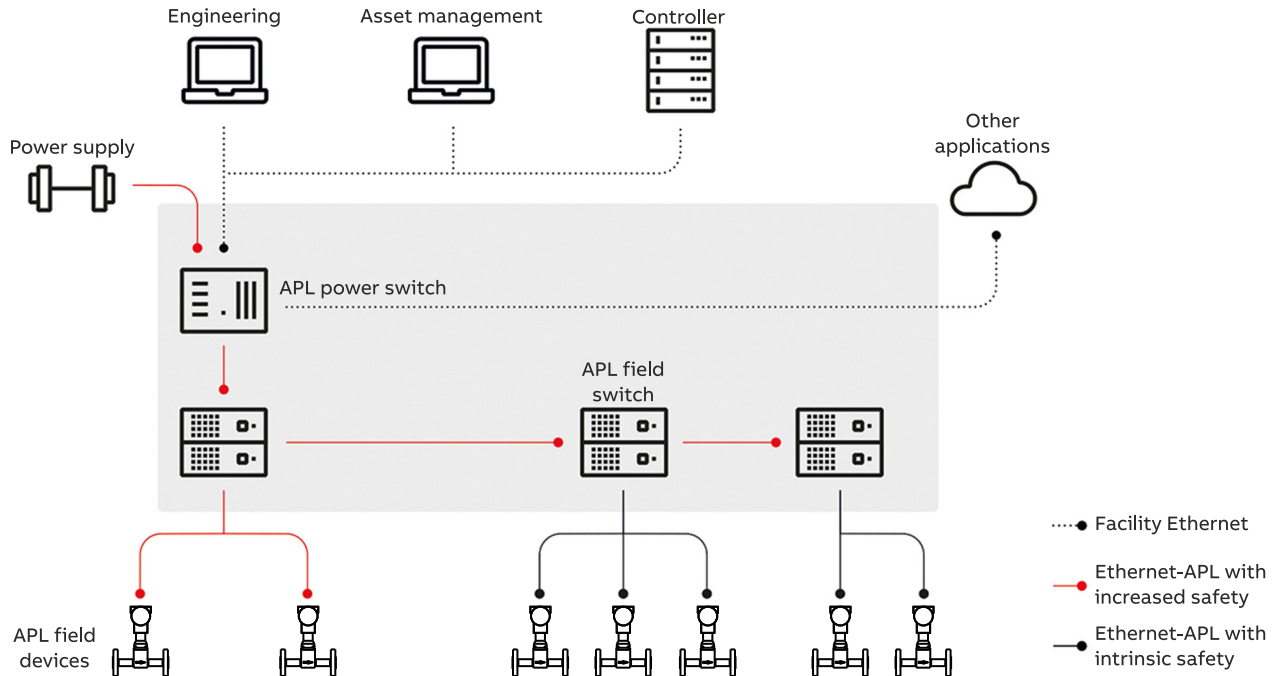

Figure 47: Exemplary Ethernet-APL topology

Ethernet-APL is designed to support various installation topologies, with optional redundancy or resiliency concepts and trunk-and-spur.

The trunk provides high power and signal levels for long cable lengths, up to 1000 m (3281 ft).

Whereas, the spur carries lower power with optional intrinsic safety for lengths up to 200 m (656 ft).

Ethernet-APL explicitly specifies point-to-point connections only with each connection between communications partners constituting a segment. Ethernet-APL switches thus isolate communications between segments.

The Ethernet-APL field switch/device used must be certified for use in the intended hazardous area location.

More network topology used in areas with explosive atmosphere please refer to '[Ethernet-APL Engineering Guideline](#)'. See www.ethernet-apl.org for more information.

Note

The SwirlMaster FSS400, VortexMaster FSV400 only support star network topology. Ring and daisy chain network configurations are currently not supported.

Ethernet-APL™ segment lengths

The permissible segment length is:

- Trunk: < 1000 m (3281 ft)
- Spur: < 200 m (656 ft)

Devices with Modbus RTU® communication

Note

The Modbus® protocol is an unsecured protocol (in terms of IT and cyber security), as such the intended application should be assessed to ensure that this protocol is suitable before implementation.

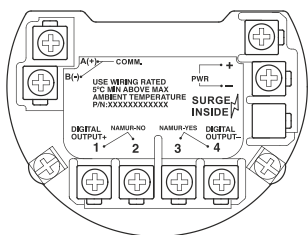

Figure 48: Terminals FSx430

Terminal	Function / comment
PWR +	Power supply
PWR -	
A (+)	Modbus interface RS485
B (-)	
DIGITAL OUTPUT 1+	Digital output, positive pole
DIGITAL OUTPUT 2	Bridge after terminal 1+, NAMUR output deactivated
DIGITAL OUTPUT 3	Bridge after terminal 4-, NAMUR output activated
DIGITAL OUTPUT 4-	Digital output, negative pole

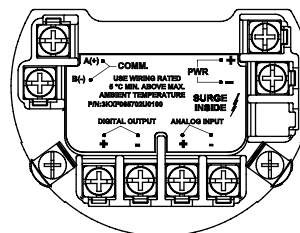

Figure 49: Terminals FSx450

Terminal	Function / comment
PWR +	Power supply
PWR -	
A (+)	Modbus interface RS485
B (-)	
DIGITAL OUTPUT +	Digital output, positive pole
DIGITAL OUTPUT -	Digital output, negative pole
ANALOG INPUT +	Analog input, positive pole
ANALOG INPUT -	Analog input, negative pole

Power supply

Devices with Modbus® communication	
Terminals	PWR + / PWR -
Supply voltage	9 to 30 V DC
Residual ripple	Maximum 5 % or $U_{SS} = \pm 1.5$ V
Power consumption	< 1 W
U_{SS}	Peak-to-peak value of voltage

Digital output

For electric data of the digital output, see **Digital output – Electrical data** on page 49.

... 8 Digital communication

... Devices with Modbus RTU® communication

Modbus communication

Using the Modbus protocol allows devices made by different manufacturers to exchange information via the same communication bus, without the need for any special interface devices to be used.

Up to 32 devices can be connected on one Modbus line. The Modbus network can be expanded using repeaters.

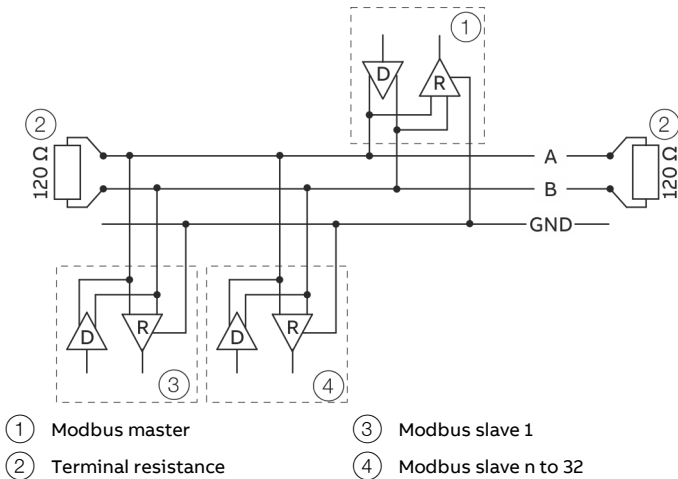

Figure 50: Modbus network (example)

Modbus interface

Configuration	Via the Modbus interface in connection with Asset Vision Basic (DAT200) and a corresponding Device Type Manager (DTM)
Transmission	Modbus RTU - RS485 serial connection
Baud rate	1200, 2400, 4800, 9600 bps Factory setting: 9600 bps
Parity	None, even, odd Factory setting: none
Typical response time	< 100 milliseconds
Response Delay Time	0 to 200 milliseconds Factory setting: 50 milliseconds
Device address	1 to 247 Factory setting: 247
Register address offset	One base, Zero base Factory setting: One base

Cable specification

The maximum permissible length depends on the baud rate, the cable (diameter, capacity and surge impedance), the number of loads in the device chain, and the network configuration (2-core or 4-core).

- At a baud rate of 9600 and with a conductor cross-section of at least 0.14 mm² (AWG 26), the maximum length is 1000 m (3280 ft).
- If a four-core cable is used in a two-wire system, the maximum length must be divided in half.
- The spur lines must be short (maximum of 20 m (66 ft)).
- When using a distributor with 'n' connections, the maximum length of each branch is calculated as follows: 40 m (131 ft) divided by 'n'.

The maximum cable length depends on the type of cable used. The following standard values apply:

- Up to 6 m (20 ft):
cable with standard shielding or twisted-pair cable.
- Up to 300 m (984 ft):
double twisted-pair cable with overall foil shielding and integrated earth cable.
- Up to 1200 m (3937 ft):
double twisted-pair cable with individual foil shielding and integrated earth cables. Example: Belden 9729 or equivalent cable.

A category 5 cable can be used for Modbus RS485 up to a maximum length of 600 m (1968 ft). For the symmetrical pairs in RS485 systems, a surge impedance of more than 100 Ω is preferred, especially at a baud rate of 19200 and above.

Devices with PROFIBUS PA® or FOUNDATION-Fieldbus® communication

Note

The PROFIBUS PA® or FOUNDATION Fieldbus® protocols are unsecured protocols (in terms of IT or cyber security), as such the intended application should be assessed to ensure that these protocols are suitable before implementation.

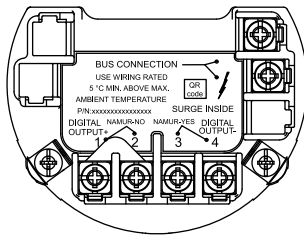

Figure 51: Terminals

Terminal	Function / comment
BUS CONNECTION	Power supply and PROFIBUS PA® /
BUS CONNECTION	FOUNDATION Fieldbus® interface
DIGITAL OUTPUT 1+*	Digital output, positive pole
DIGITAL OUTPUT 2*	Bridge after terminal 1+, NAMUR output deactivated
DIGITAL OUTPUT 3*	Bridge after terminal 4-, NAMUR output activated
DIGITAL OUTPUT 4-*	Digital output, negative pole

* Not active in devices with FOUNDATION Fieldbus® communication.

Power supply

Devices with PROFIBUS PA® or FOUNDATION Fieldbus® communication.

Terminals	BUS CONNECTION
Supply voltage	9 to 32 V DC
Input Current	~ 10 to 20 mA

Digital output

For electric data of the digital output, see **Digital output – Electrical data** on page 49.

Cable specification

The Fieldbus cable to connect the devices with each other must fulfill the following specifications.

Loop resistance R

15 to 150 Ω /km

Inductance L

0.4 to 1 μ H/km

Capacitance C

80 to 200 nF/km

Cable length

Spur line: maximum 30 m

Trunk line: maximum 1 km

Bus termination

Passive at both ends of the main bus line
(RC element R = 90 to 100 Ω , C = 0 to 2.2 μ F).

... 8 Digital communication

... Devices with PROFIBUS PA® or FOUNDATION-Fieldbus® communication

PROFIBUS PA®

PROFIBUS PA® Interface	
Terminals	BUS CONNECTION
Configuration	Via the PROFIBUS PA interface or the local LCD indicator
Transmission	In accordance with IEC 61158-2
Baud rate	9.6 kbps, 19.2 kbps, 45.45 kbps, 93.75 kbps, 187.5 kbps, 500 kbps, 1.5 Mbps The baud rate is automatically detected and does not need to be configured manually
Device profile	PA Profile 3.02
Bus address	Address range 0 to 126 Factory setting: 126

A device driver in the form of a EDD (Electronic Device Description) DTM (Device Type Manager) as well as a GSD file is required for commissioning.

You can download EDD, DTM and GSD from www.abb.de/flow.

The files required for operation can also be downloaded from www.profibus.com.

ABB provides three different GSD files which can be integrated in the system.

ID number	GSD file name	Blocks
0x9700	—	1×AI
0x9740	—	1×AI, 1×TOT
0x3433	ABB_3433.gsd	4×AI, 3×AO, 1×DI, 3×TOT

Users decide at system integration whether to install the full range of functions or only part. Switching is made using the 'IdentNr Selector' parameter.

Structure and design of the function blocks

Block structure	Supported PROFIBUS ID numbers		
	0x3433	0x9740	0x9700
Physical Block	Slot 0	Slot 0	Slot 0
Analog Input Block (AI)	Slot 1	Slot 1	Slot 1
	Slot 2	—	—
	Slot 3	—	—
	Slot 4	—	—
Analog output block (AO)	Slot 5	—	—
	Slot 6	—	—
	Slot 7	—	—
Discrete Input Block (DI)	Slot 8	—	—
Totalizer Block (TOT)	Slot 9	Slot 9	—
	Slot 10	—	—
	Slot 11	—	—
Transducer Block-HMI	Slot 12	Slot 12	Slot 12
Transducer Block-PCB	Slot 13	Slot 13	Slot 13
Transducer Block-Standard	Slot 14	Slot 14	Slot 14

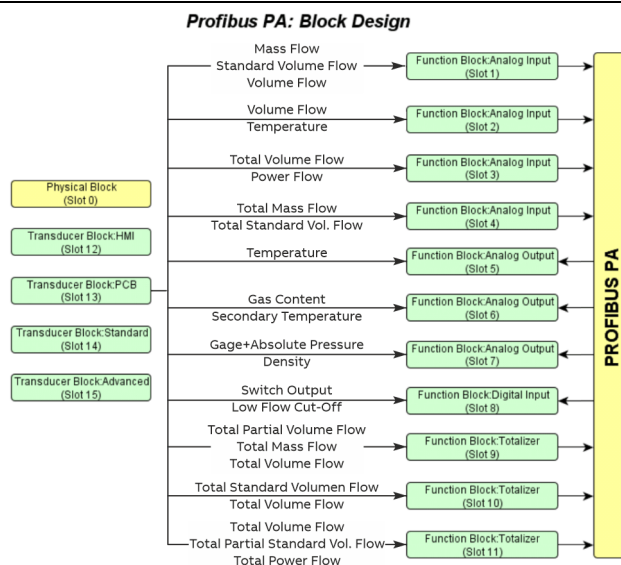

Figure 52: Design of the function blocks

Note

For additional information on the PROFIBUS PA® interface, refer to the separate COM/FSV/FSS/430/450/PB interface description!

FOUNDATION Fieldbus®

FOUNDATION Fieldbus® Interface	
Terminals	BUS CONNECTION
Configuration	Via the FOUNDATION Fieldbus interface or the local LCD indicator
Transmission	FOUNDATION Fieldbus H1 in accordance with IEC 61158-2
Baud rate	9.6 kbps, 19.2 kbps, 45.45 kbps, 93.75 kbps, 187.5 kbps, 500 kbps, 1.5 Mbps The baud rate is automatically detected and does not need to be configured manually
Interoperability test campaign no.	ITK 6.3.0
Manufacturer ID	0x000320
Device ID	0x12C
Bus address	Address range 0 to 126 Factory setting: 126

A device driver in the form of an EDD (Electronic Device Description) / CFF file (Common File Format) is required for commissioning purposes.

You can download the EDD and CFF at www.abb.de/flow.

The files required for operation can also be downloaded from www.fieldbus.org.

Structure and design of the function blocks

Block structure	
Ordinal	Block
0	RESOURCE_2_FD
1	TB0: HMI
2	TB1: PCB
3	TB2: Standard
4	TB3: Advanced
5	AI1
6	AI2
7	AI3
8	AI4
9	AO1
10	AO2
11	AO3
12	DI
13	IT
14	EPID

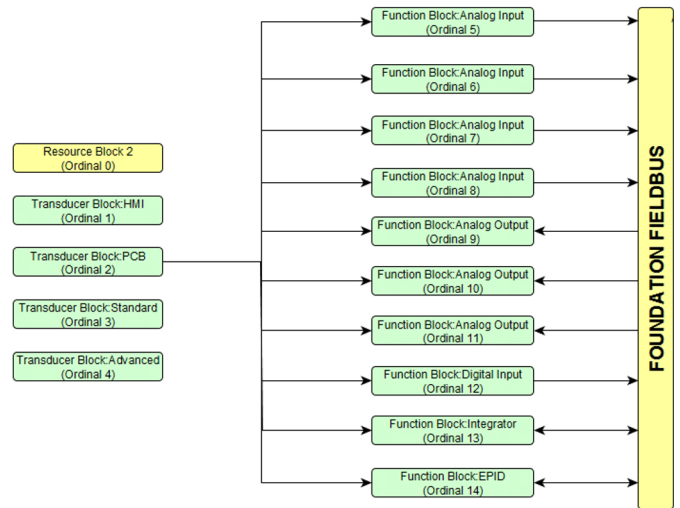

Figure 53: Design of the function blocks

... 8 Digital communication

... Devices with PROFIBUS PA® or FOUNDATION-Fieldbus® communication

FOUNDATION Fieldbus® Channel Assignment (Channel)	
AI Channel	Process value
1	Volume flow
2	Partial volume flow
3	Standard volume flow
4	Partial standard volume flow
5	Mass flow
6	Energy
7	Temperature
8	Volume flow counter
9	Partial volume flow counter
10	Standard volume flow counter
11	Partial standard volume flow counter
12	Mass flow counter
13	Energy counter
AO Channel	Process value
14	Temperature
15	Second temperature
16	Gauge pressure
17	Absolute pressure
18	Density
19	Gas content
DI Channel	
20	Switch output
21	Low flow cutoff

Note

For additional information on the FOUNDATION Fieldbus® interface, refer to the separate COM/FSV/FSS/430/450/FF interface description!

9 Commissioning

Safety instructions

⚠ DANGER

Danger of explosion if the device is operated with the transmitter housing or terminal box open!

Before opening the transmitter housing or the terminal box, note the following points:

- Check that a valid fire permit is available.
- Make sure that there is no explosion hazard.
- Before opening the device, switch off the power supply and wait for $t > 2$ minutes.

⚠ CAUTION

Risk of burns due to hot measuring media

The device surface temperature may exceed 70 °C (158 °F), depending on the measuring medium temperature!

- Before starting work on the device, make sure that it has cooled sufficiently.

General

The commissioning of the device depends on the communication version (HART®, Modbus RTU®).

Commissioning is divided into a general part and fieldbus-dependent information.

General commissioning

The following chapters address general commissioning:

- **Checks prior to commissioning** on page 69
- **Power Supply Power-Up** on page 69
- **Devices with HART®, Modbus® or Ethernet-APL™ communication** on page 78

Commissioning of devices with HART®, Modbus RTU® and Ethernet-APL communication

See **Devices with HART®, Modbus® or Ethernet-APL™ communication** on page 78..

Hardware settings

Digital output

Not active in devices with FOUNDATION Fieldbus® communication!

It is possible to use software to configure the optional digital output as an alarm, frequency or pulse output.

It is possible to use a bridge to configure the digital output as an optoelectronic coupler output or a NAMUR output.

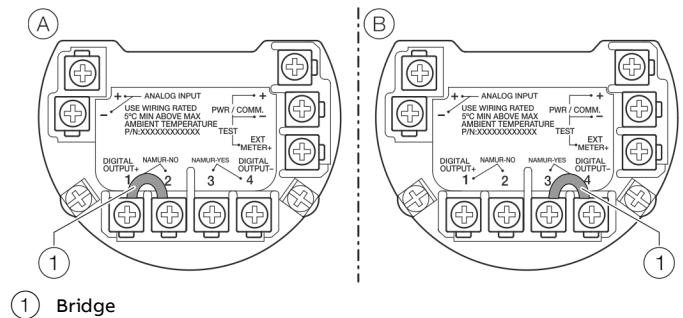

Figure 54: Hardware configuration of the digital output

Output configuration	Bridge
Optoelectronic coupler output	1-2
NAMUR output	3-4

In the factory setting, the output is configured as an optoelectronic coupler output.

Note

The type of protection of the outputs remains unchanged, regardless of the output configuration. The devices connected to the digital output must conform to the current regulations for explosion protection.

... 9 Commissioning

... Hardware settings

Devices with HART® communication

Current output 4 to 20 mA / HART®

In the factory setting, the flow signal is emitted via the current output of 4 to 20 mA. Alternatively, the temperature signal can be assigned to the current output.

Analog input 4 to 20 mA

Only for FSx450 with HART® communication!

External devices can be connected to the passive analog input (4 to 20 mA).

The function of the analog input can be selected via the software ('Input/Output' menu).

The analog input can be configured via the 'Easy Setup' menu or the setup menu of the device. Before starting the configuration, select the type of the connected signal and then select the values for 4 mA and 20 mA that correspond to the relevant output values of the connected device.

HART® Input

Only for devices with HART® communication!

The HART input can be configured via the 'Easy Setup' menu or the setup menu of the device.

The device recognizes the value and the corresponding unit via the HART input.

The remote transmitter must be operated in HART burst mode.

If, for example, the pressure unit is set to psi in the setup menu of the device, but the pressure unit of the connected pressure transmitter is set to kPa, the VortexMaster / SwirlMaster takes the pressure unit from the pressure transmitter.

Note

The use of the ABB Pressure transmitter model 266 with 'HART Burst Mode' is recommended.

DIP switch on the HART® communication board

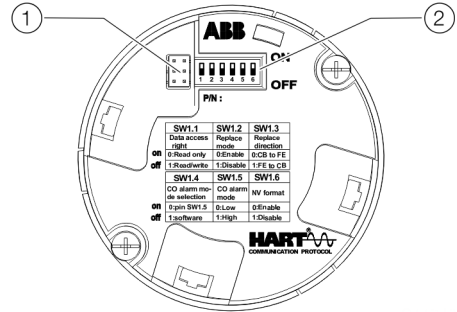

① Interface for LCD indicators and ② DIP switch service port

Figure 55: HART communication board / 4 to 20 mA

DIP switch	Function
SW 1.1	Write protection switch On: Write protection active Off: Write protection deactivated
SW 1.2	Replacement mode (transfer system data) On: Replacement mode active Off: Replacement mode deactivated
SW 1.3	System data transfer direction On: Transmitter -> sensor Off: Sensor -> transmitter
SW 1.4	Selection whether the alarm function is configured via software or DIP switch. On: Selection of alarm current via SW 1.5 Off: Selection of alarm current via the 'Input/Output / Iout at Alarm' menu.
SW 1.5	Selection of alarm current On: Low alarm (3.5 to 3.6 mA) Off: High alarm (21.0 to 22.6 mA)
SW 1.6	Format SensorMemory Service function! - Risk of data loss in the device.

The communication board is located behind the front housing cover. The LCD indicator may have to be removed to provide access to the DIP switches.

The DIP switches are used to configure specific hardware functions. The power supply to the transmitter must be briefly interrupted in order for the modified setting to take effect.

The interface for the LCD indicator is also used as the service port for device configuration.

Write-protect switch

When write protection is activated, device parameterization cannot be changed via HART or the LCD indicator. Activating and sealing the write protection switch protects the device against tampering

Note

The product has an ABB Service Account, which can be deactivated with this write protection switch.

Downloading system data, replacing the transmitter

When replacing transmitter components (communication board), system data must be downloaded from the SensorMemory.

Download of system data and the system data transfer direction is activated using DIP switches SW 1.2 and SW 1.3.

Refer to **Replacing the transmitter, downloading system data** on page 147.

Status of the current output

DIP switches SW 1.4 and SW 1.5 can be used to configure the status of the current output in the event of an alarm / error.

If the current in the event of an alarm is selected via DIP switch SW 1.5, the setting can no longer be changed using HART or the LCD indicator.

... 9 Commissioning

Devices with Ethernet-APL™ communication

DIP switch on the FSx430 / FSX450 Ethernet-APL communication board

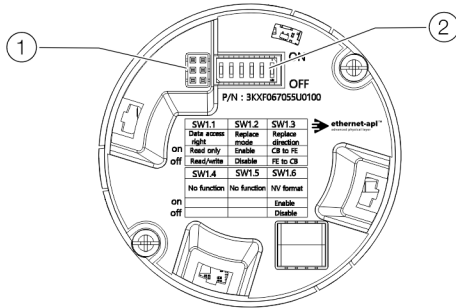

① Interface for LCD indicators and service port ② DIP switch service port

Figure 56: Ethernet-APL communication board

DIP switch	Function
SW 1.1	Write protection switch On: Write protection active Off: Write protection deactivated
SW 1.2	Replacement mode (transfer system data) On: Replacement mode active Off: Replacement mode deactivated
SW 1.3	System data transfer direction On: Transmitter -> sensor Off: Sensor -> transmitter
SW 1.4	No function
SW 1.5	No function
SW 1.6	Format SensorMemory Service function! – Risk of data loss in the device.

The communication board is located behind the front housing cover. The LCD indicator may have to be removed to provide access to the DIP switches.

The DIP switches are used to configure specific hardware functions. The power supply to the transmitter must be briefly interrupted in order for the modified setting to take effect. The interface for the LCD indicator is also used as the service port for device configuration.

Write-protect switch

If write protection is active, the device parameterization cannot be changed. Activating and sealing the write protection switch protects the device against tampering

Note

The product has an ABB Service Account, which can be deactivated with this write protection switch.

Downloading system data, replacing the transmitter

When replacing transmitter components (communication board), system data must be downloaded from the SensorMemory.

Loading system data and the system data transfer direction is activated using DIP switches SW 1.2 and SW 1.3.

Refer to **Replacing the transmitter, downloading system data** on page 147.

Devices with Modbus RTU® communication

DIP switch on the FSx430 / FSX450 Modbus communication board

For Firmware ≥ 02.xx.xx

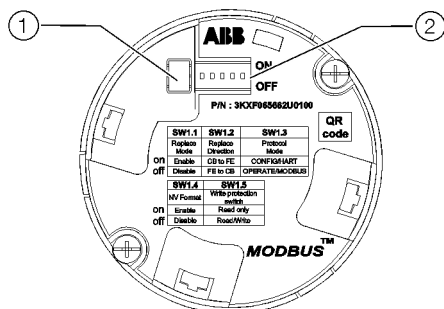

- ① Interface for LCD indicators and service port ② DIP switch

Figure 57: Modbus communication board

DIP switch	Function
SW 1.1	Replacement mode (transfer system data) On: Replacement mode active Off: Replacement mode deactivated
SW 1.2	System data transfer direction On: Transmitter -> sensor Off: Sensor -> transmitter
SW 1.3	Protocol mode On: CONFIG/HART protocol Off: OPERATE/MODBUS protocol
SW 1.4	Format SensorMemory Service function! – Risk of data loss in the device.
SW 1.5	Write protection switch On: Write protection active Off: Write protection deactivated

The communication board is located behind the front housing cover. The LCD indicator may have to be removed to provide access to the DIP switches.

The DIP switches are used to configure specific hardware functions. The power supply to the transmitter must be briefly interrupted in order for the modified setting to take effect.

The interface for the LCD indicator is also used as the service port for device configuration.

Write-protect switch

If write protection is active, the device parameterization cannot be changed. Activating and sealing the write protection switch protects the device against tampering

Note

The product has an ABB Service Account, which can be deactivated with this write protection switch.

Downloading system data, replacing the transmitter

When replacing transmitter components (communication board), system data must be downloaded from the SensorMemory.

Loading system data and the system data transfer direction is activated using DIP switches SW 1.1 and SW 1.2.

Refer to **Replacing the transmitter, downloading system data** on page 147.

... 9 Commissioning

Devices with PROFIBUS PA® or FOUNDATION-Fieldbus® communication

DIP switch on the PROFIBUS PA®- / FOUNDATION Fieldbus® communication board

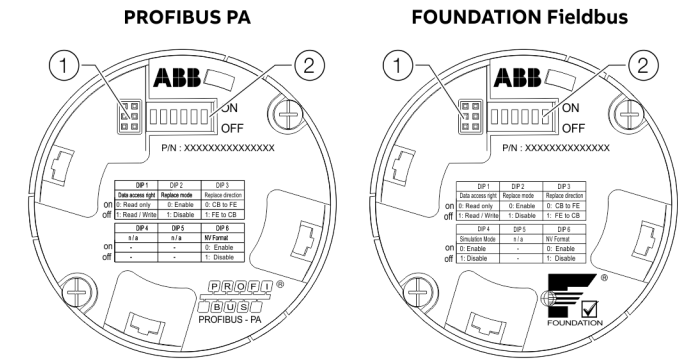

① Interface for LCD indicators and service port ② DIP switch

Figure 58: PA/FF communication board

DIP switch	Function
DIP 1	Write protection switch On: Write protection active Off: Write protection deactivated
DIP 2	Replacement mode (transfer system data) On: Replacement mode active Off: Replacement mode deactivated
DIP 3	System data transfer direction On: Transmitter -> sensor Off: Sensor -> transmitter
DIP 4	Simulation mode (only with FOUNDATION Fieldbus) On: Simulation mode active Off: Simulation mode deactivated
DIP 5	No function
DIP 6	Format SensorMemory Service function! – Risk of data loss in the device.

The communication board is located behind the front housing cover. The LCD indicator may have to be removed to provide access to the DIP switches.

The DIP switches are used to configure specific hardware functions. The power supply to the transmitter must be briefly interrupted in order for the modified setting to take effect. The interface for the LCD indicator is also used as the service port for device configuration.

Write-protect switch

When write protection is activated, device parameterization cannot be changed via the Fieldbus or the LCD indicator. Activating and sealing the write protection switch protects the device against tampering

Note

The product has an ABB Service Account, which can be deactivated with this write protection switch.

Downloading system data, replacing the transmitter

When replacing transmitter components (communication board), system data must be downloaded from the SensorMemory.

Loading system data and the system data transfer direction is activated using the DIP 2 and DIP 3 DIP switches. Refer to **Replacing the transmitter, downloading system data** on page 147.

Simulation mode (only with FOUNDATION Fieldbus)

You can release the simulation of AI function blocks with the DIP 4 DIP switch.

Checks prior to commissioning

The following points must be checked before commissioning:

- The power supply must be switched off.
- The power supply used must match the information on the name plate.
- Correct wiring in accordance with **Electrical connections** on page 44.
- Correct grounding in accordance with **Grounding** on page 45.
- The ambient conditions must meet the requirements set out in the specification.
- The transmitter must be installed at a location largely free of vibrations.
- The housing cover and cover lock must be sealed before powering-up the power supply.
- For devices with a remote mount design, make sure that the sensor and transmitter are assigned correctly.

Power Supply Power-Up

1. Switch on the device power supply.
After switching on the power supply, the system data in the SensorMemory is compared with the values stored internally in the transmitter.
 - If the system data is not identical, it is matched automatically.
- The flowmeter is now ready for operation.
- The LCD display shows the process display.

Checks after switching on the power supply

The following must be checked after commissioning the device:

- Parameter configuration must correspond to the operating conditions.
- The system zero point is stable.
If this is not the case, a zero point balance must be carried out (see **Zero point balance under operating conditions** on page 134).

... 9 Commissioning

Parameterization of the device

The SwirlMaster FSS400, VortexMaster FSV400 can be commissioned and operated via the integral LCD indicator (see **Parameterization via the menu function Easy Setup** on page 74).

Alternatively, the SwirlMaster FSS400, VortexMaster FSV400 can also be commissioned and operated via standard HART tools.

These include:

- ABB HART handheld terminal DHH805 (FSx400 EDD)
- ABB Field Information Manager (FIM) combined with the ABB Field Device Information Package (FDI package).
- ABB 800xA control system (FSx400 DTM)
- Other tools supporting standard HART EDDs or DTMs (FDT1.2)

Note

Not all tools and frame applications support DTMs or EDDs at the same level. In particular, optional or advanced EDD / DTM functions may not be available on all tools. ABB provides frame applications supporting the full range of functions and performance.

Factory settings

The device can be factory parameterized to customer specifications upon request. If no customer information is available, the device is delivered with factory settings.

Parameter	Factory setting
Active Mode	Liquid Volume
Output Value	Flow rate
DO Function	No function
Q_{max}	Actual value set to $Q_{max, DN}$. Depending on the nominal diameter of the flowmeter.
Unit Q	m^3/h
Analog In Value	No function
HART In Value	No function
Low Flow Cutoff	4 %
Out at Alarm	Low Alarm Value
Low Alarm Value	3.55 mA
High Alarm Value	22 mA

Installation of the ABB Field Information Manager (FIM)



Download the ABB Field Information Manager (FIM) using the adjacent download link.



Download the ABB FDI package using the adjacent download link.

Installation of the software and connection to the flowmeter:

1. Install ABB Field Information Manager (FIM).
2. Unpack the ABB FDI package into the c:\temp folder.
3. Connect the flowmeter with the PC / laptop, see chapter **Parameterization via HART®** on page 71.
4. Power-up the power supply for the flowmeter and start the ABB Field Information Manager (FIM).
5. Drag and drop the 'ABB.FSx400.01.05.00.HART.fdiX' file to the ABB Field Information Manager (FIM). No special view is needed for this.
6. Right-click ① as shown in **Figure 59**.

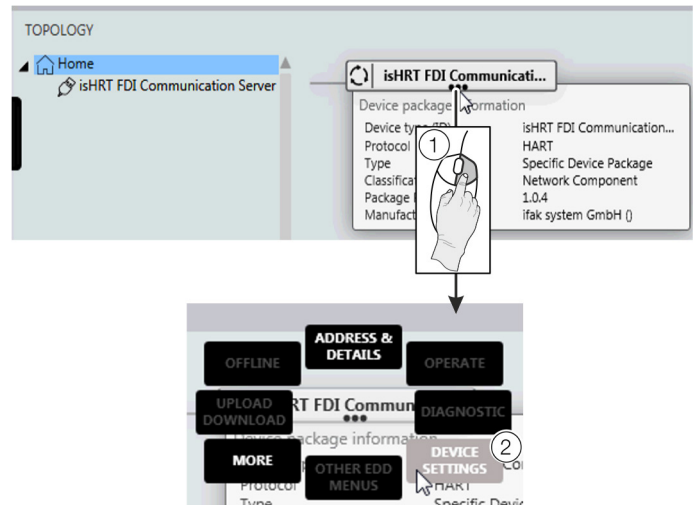

Figure 59: Select FIM – 'Device Settings'

7. Select 'DEVICE SETTINGS' ② as shown in **Figure 59**.

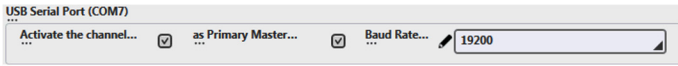



Figure 60: Select FIM – COM-Port

8. Select the corresponding COM port. Close the menu by clicking on 'send'.
9. By using the  menu button on the left side, the flowmeter is displayed under 'TOPOLOGY'.

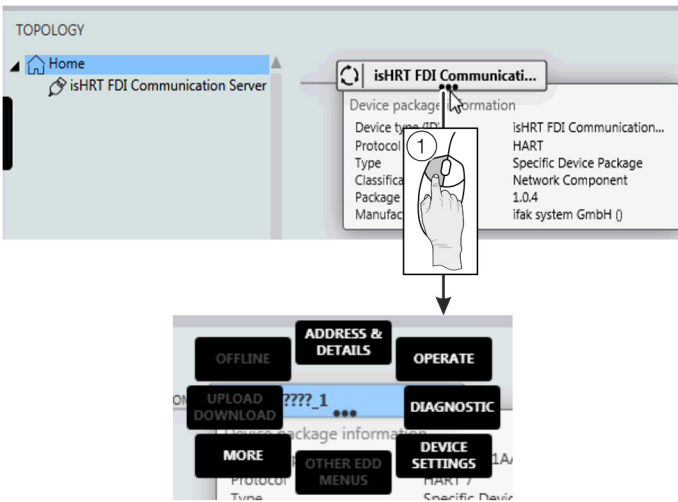

Figure 61:

All the submenus can be accessed by clicking the three points below the tag name of the flowmeter with the left mouse button ①.

Parameterization via HART®

Configuration via the HART interface of the device requires a PC / Notebook and a suited HART® Modem.

By combining the HART DTM available at www.abb.com/flow and the ABB Field Information Manager (FIM), all parameters can also be set via the HART protocol.

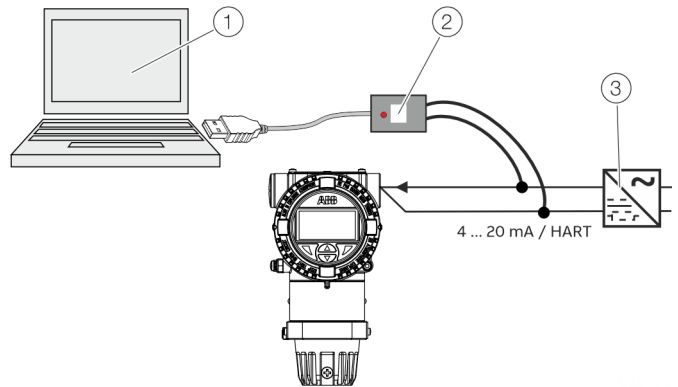

- ① PC / notebook with HART DTM
- ② HART modem
- ③ Power supply unit

Figure 62: HART Modem on the transmitter (example)

For more detailed information on operating the software and the HART modem, please refer to the relevant operating instructions and the DTM online help.

... 9 Commissioning

... Parameterization of the device

Parameterization via My Device Manager mobile app

Bluetooth connection process

The first time when a phone, tablet or PC will be connected to a device with Smart HMI, the devices need to be paired. This pairing process need to be done one time only, after that the devices will reconnect automatically when the smart phone, tablet or PC is getting inside the range of the Bluetooth.

In the Pairing Process, the Bluetooth LED flashes and the SmartHMI as Bluetooth slave will request a 'Pairing key' from a PC, tablet or Phone as Bluetooth Master. The user can input the pairing key by PC or Phone and the SmartHMI will check it.

If the pairing is succeeded, Master and Slave will exchange their Bluetooth configuration and negotiate a communication standard automatically.

NOTICE

Effect on the current output in pairing mode

Devices with HART communication (output signal H1 or H5) will set the current output to 22 mA high alarm current in the pairing mode.

- Make sure to disconnect the device from the control loop before starting the pairing mode!

Note

- One PC or Phone (Master) can connect with several SmartHMIs (Slave) at same time.
- One SmartHMI (Slave) can only connect with one PC or Phone (Master) at same time.
- If Bluetooth is enabled, the SmartHMI will do Bluetooth advertising when no Master Device is connected to Smart HMI.

For devices with Smart HMI only, order code 'Integrated Digital Display (LCD) – LE'



My Device
Manager

ABB Information Systems AG

The ABB My Device Manager mobile app let the user configure transmitter from a safe place with just the need of a smart phone supporting Bluetooth 5.

Visit google play store to download the app:

[ABB My Device Manager](#)



Note

For detailed information on operating the ABB My Device Manager APP, please refer to the associated user manual 'UM/MY_DEVICE_MANAGER'

Pairing Key

To connect to transmitter with the phone, a pairing key is required. Pairing is the standard method on Bluetooth to limit access to authorized users only and properly secure the communication by encryption.

- Default pairing key: 123456

Note

For data security reasons, we strongly recommend that you change the default pairing key during initial setup.

Discover devices

- Open the My Device Manager app and select <Discover Devices> menu.
 - It will show all supported devices in range by the transmitters serial number (usually starting with 3K), grouped by 'paired' and 'unpaired'. If a device is not listed, please check:
 - Is the Bluetooth enabled on phone?
 - Does the transmitter have a SmartHMI connected?
 - Has the device the correct firmware?
 - Check with ABB service about options to receive an upgrade for the transmitter.
 - Is the Bluetooth enabled in SmartHMI?
 - See chapter **Menu: Display** on page 116 how to enable/disable Bluetooth connectivity.
 - Is the device in range as per **Figure 63**?
 - Move closer in case of doubt.
 - Is the (HART) device in low alarm condition?
 - During low alarm current the pairing function is disabled!

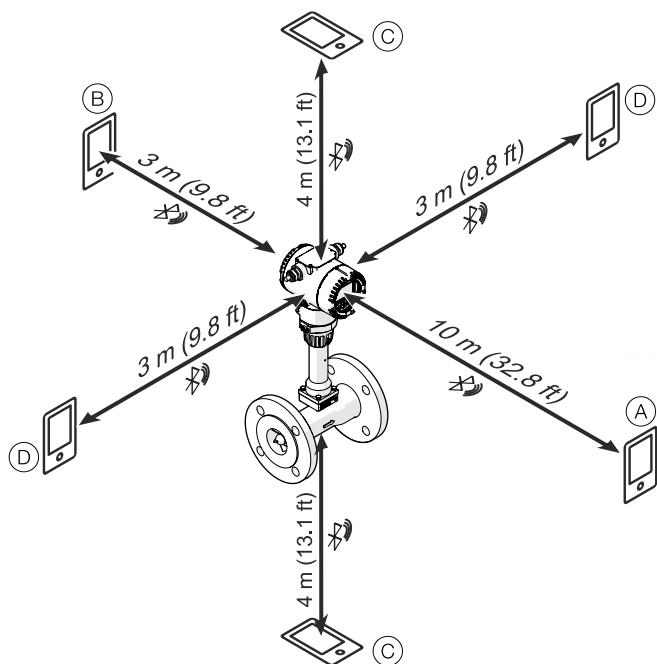

Distances for pairing, broadcast and configuration

- | | |
|-----------|-------------------|
| (A) Front | (C) Above / under |
| (B) Back | (D) Left / right |

Figure 63: Bluetooth reception area

Note

The Discover Devices screen shows devices in range (whether paired or unpaired) with:

- Serial number as unique identifier
- Device type (e.g. FSV430)
- Measurement type (e.g. Flow)
- Primary communication type (e.g. HART)
- Main measurement value (PV = primary value) and configured unit
- Device health as described by NAMUR NE107
- Picture of the device for easier recognition

The Discover Devices screen gets updated automatically. It may take up to 30 s to observe changes depending on number of devices in range.

- Once the device is listed in <unpaired> section, select the device and slide right within the title of the name box or tapping on icon. Select the Pairing option to pair with the device.
- Pairing PIN popup is display after 3 seconds. Enter configured pairing key and device will move from <unpaired> to <paired> section.
- Select the Device Configuration option to open the Device Configuration screen. The Device Configuration screen allows for interaction with the device for configuration and monitoring.

... 9 Commissioning

Parameterization via the menu function Easy Setup

Settings for the most common parameters are summarized in the 'Easy Setup' menu. This menu provides the fastest way to configure the device. The next respective parameter is called out by  (Next).

Note

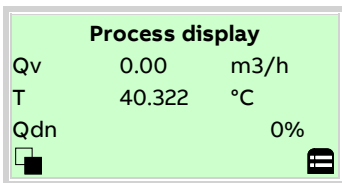

The LCD display is provided with capacitive control buttons. These enable you to control the device through the closed housing cover.

Open the Menu Easy Setup

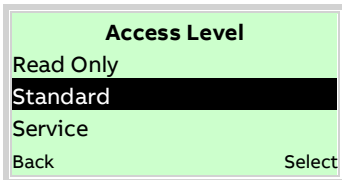

1. Switch to the configuration level using .



2. Use  /  'Standard' to make the selection.
3. Confirm the selection with .

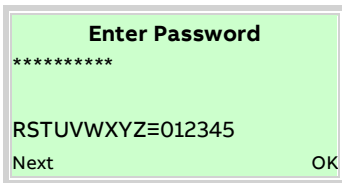



4. Use  to confirm the password. A password is not available as factory default; you can continue without entering a password.

Note

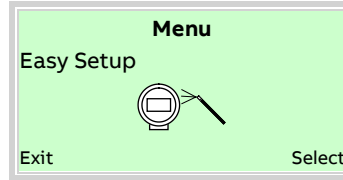



For security reasons it is recommended, to set a password.



5. Use  /  'Easy Setup' to make the selection.
6. Confirm the selection with .

Selection of the menu language





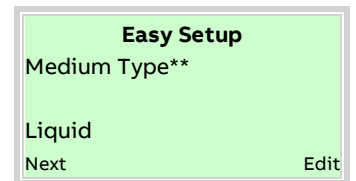
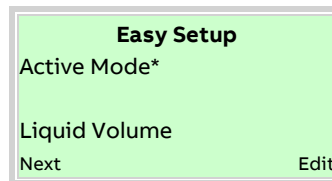

1. Use  to call up the edit mode.
2. Use  /  to select the desired language.
3. Confirm the selection with .

Select the operating mode* / measuring medium**

For more information on the operating mode*, refer to **Operating modes** on page 78.



1. Use  to call up the edit mode.
2. Use  /  to select the desired operating mode* / measuring medium**.
3. Confirm the selection with .



* Only for devices with HART® and Modbus® communication.

** Only for devices with PROFIBUS® or FOUNDATION Fieldbus® communication.

Configuration of the current output



Only for devices with HART® communication!

Easy Setup	
Output Value*	
Flow rate	
Next	Edit

1. Use  to call up the edit mode.
2. Use  to select the desired process value for the current output.
3. Confirm the selection with .



Configuration of the digital output

Easy Setup	
DO Function	
Logic on DO	
Next	Edit

1. Use  to call up the edit mode.
2. Use  to select the desired operating mode for the digital output.
 - Logic on DO: Operation as a switch output.
 - Pulse on DO: In pulse mode, pulses are emitted per unit.
 - Freq on DO: In frequency mode, a frequency proportional to the flow is emitted.
3. Confirm the selection with .



Easy Setup	
Pulses Per Unit	
0000001 /l	
Next	Edit

Easy Setup	
Upper Frequency	
1.00 Hz	
Next	Edit



4. Use  to call up the edit mode.
5. With the help of , set the pulses per unit (Pulse on DO) or the upper frequency (Freq on DO).
6. Confirm the selection with .

Easy Setup	
Pulse Width	
0000001 ms	
Next	Edit

Easy Setup	
Lower Frequency	
1.00 Hz	
Next	Edit

7. Use  to call up the edit mode.
8. With the help of , set the pulse width (Pulse on DO) or the lower frequency (Freq on DO).
9. Confirm the selection with .



Easy Setup	
Logic on DO	
Normally Open	
Next	Edit

10. Use  to call up the edit mode.
11. Select the switching behavior for the binary output using .
12. Confirm the selection with .

Selection of the units

In the following menus, the units for the following process values are selected: volume, mass, standard volume, power, density, temperature, pressure, volume flowmeter, mass flowmeter, standard volume flowmeter and energy meter.

Easy Setup	
Unit	
xx.xx	
Next	Edit

1. Use  to call up the edit mode.
2. Use  to select the desired unit for the respective process value.
3. Confirm the selection with .

... 9 Commissioning

... Parameterization via the menu function Easy Setup

Configuration of the analog / HART input

Only for devices with HART® communication!

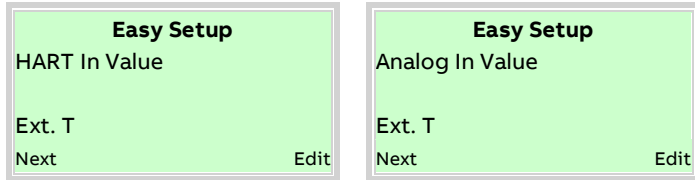

1. Use to call up the edit mode.
2. Use / to select the desired function for the analog / HART input.

HART In Value	Analog In Value	Function
Ext. T	Ext. T	External temperature transmitter downstream for energy measurement
Pressure	Pressure	External pressure transmitter
Gas Content	Gas Content	External gas analyzer
Density	Density	External density transmitter
Int.T	Int.T	External temperature transmitter upstream for energy measurement
-	Ext. Cutoff	External output zero return

3. Confirm the selection with .

In the following menus, the measurement range limits for the external transmitters are fixed at the analog input.

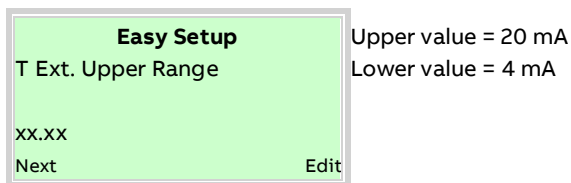

4. Use to call up the edit mode.
5. Use / to set the measuring range limits for the respective process value.
6. Confirm the selection with .

Configuration of the parameters dependent on the operating mode

Only for devices with HART® communication!

The parameters shown in this position in the menu depend on the selected operating mode and are not presented in detail here. Refer to **Operating modes** on page 78 and **Parameter descriptions** on page 106 for detailed information!

Select the end value for the current output

Only for devices with HART® communication!

Setting of the flow rate or energy quantity at which the current output is to output 20 mA (100 %). The value entered must be at least 15 % of Q max DN.

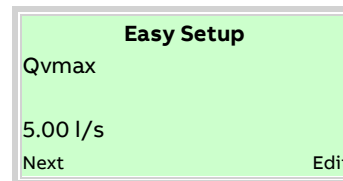

1. Use to call up the edit mode.
2. Use / to set the desired end value for the current output.
3. Confirm the selection with .

Adjusting the damping value

Adjustment of the damping for the respective process value. [the value relates to 1 T (Tau)].

The damping relates to a step change in the flow rate or energy quantity or temperature.

The damping affects the instantaneous value in the process display and at the current output.

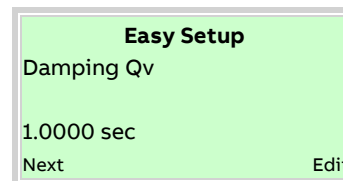

1. Use to call up the edit mode.
2. Use / to set the desired damping for the respective process value.
3. Confirm the selection with .

Configuration of the alarm signaling via the current output

Only for devices with HART® communication!

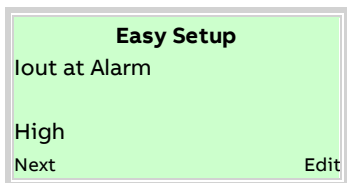

1. Use to call up the edit mode.
2. Adjust the desired state in case of faults using / .
3. Confirm the selection with .

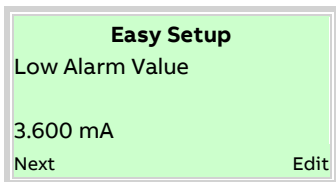
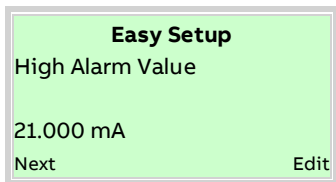

4. Use to call up the edit mode.
5. Use / / to set the alarm current.
6. Confirm the selection with .

Zero point adjustment of the flowmeter

Note

Prior to starting the zero point adjustment, make sure that:

- There is no flow through the sensor (close all valves, shut-off devices etc.)
- The sensor must be completely filled with the medium to be measured.

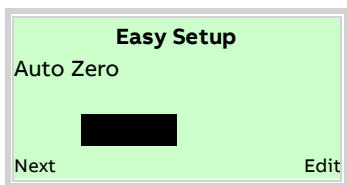

- Use to start automatic adjustment of the zero point for the system.

Configuration of the low flow cut-off

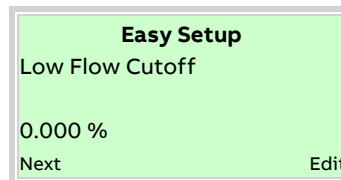

1. Use to call up the edit mode.
2. Use / / to set the desired value for the low flow cut-off.
3. Confirm the selection with .

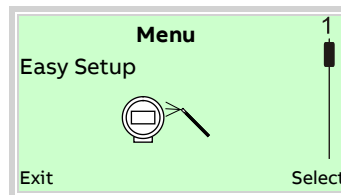

Once all parameter have been set, the main menu appears again. The most important parameters are now set.

4. Use to switch to the process display.

... 9 Commissioning

Devices with HART®, Modbus® or Ethernet-APL™ communication

Operating modes

The parameters for the different operating modes are described in the following table.

Operating mode / (order code)	Designation	Additional parameters required	Parameter setting
Liquid Volume / NL1	Operating volume flow (for liquid measuring medium)	–	–
Liquid Mass / NL3	Liquid mass flow, based on direct determination of the operating density via analog input, HART input or default setting. (for liquid measuring medium)	Operating density ^{1), 2)}	Via analog input: Input/Output / Field Input / Analog In Value -> Density Via HART input: Input/Output / Field Input / HART In Value -> Density Default setting for the density: Device Setup / Plant/Customized / Compensation Setting -> Preset Density
Gas Act. Volume / NG1	Operating volume flow (for gaseous measuring media)	–	–
Gas Std./Norm Vol. / NG2	Standard volume flow (for gaseous measuring media)	Operating pressure ^{2), 3)}	Via analog input: Input/Output / Field Input / Analog In Value -> Pressure Via HART input: Input/Output / Field Input / HART In Value -> Pressure Default setting for the pressure value: Device Setup / Plant/Customized / Compensation Setting -> Preset Pressure(abs)

- 1) The highest priority of the device is to record the density via the analog input, as long as the analog input is activated as a density input. If the analog input is not available as a density input, the system attempts to record the density via the HART input. If both the analog input and the HART input are deactivated as a density input, the system uses the default density value.
- 2) The connection via the analog input or HART input is described in **Electrical connections** on page 44.
- 3) The highest priority of the device is to record the temperature via the analog input, as long as the analog input is activated as a temperature input. If the analog input is not available as a temperature input, the system attempts to record the temperature via the HART input. If both the analog input and the HART input are deactivated as a temperature input, the system uses the default density value.

Operating mode / (order code)	Designation	Additional parameters required	Parameter setting
Gas Std/Norm Vol. / NG2	Standard volume flow (for gaseous measuring media)	Operating temperature ^{2), 3)}	With internal temperature sensor. No information required, the measured value from the temperature sensor is used. Via analog input: Input/Output / Field Input / Analog In Value -> Temperature Via HART input: Input/Output / Field Input / HART In Value -> Temperature Default setting for the temperature value: Device Setup / Plant/Customized / Compensation Setting -> Preset Int.Temp
Gas Mass (Density under reference conditions) / NG3	Mass flow rate, calculated with the density under reference conditions, pressure and temperature (for gaseous measuring media)	Reference pressure and reference temperature in the normal condition Density under reference conditions	Device Setup / Plant/Customized / Gas Ref. Conditions Via analog input: (For selection, see operating mode Gas Std/Norm Vol. / NG2) Via HART input: (For selection, see operating mode Gas Std/Norm Vol. / NG2) Device Setup / Plant/Customized / Gas Ref. Conditions, as a selection for 'Ref. Density'
Gas Mass (actual density) / NG3	Mass flow rate, calculated using the current density in the operating condition. (gaseous measuring media)	Operating density ^{2), 3)}	Via analog input: Input/Output / Field Input / Analog In Value -> Density Via HART input: Input/Output / Field Input / HART In Value -> Density

2) The connection via the analog input or HART input is described in **Electrical connections** on page 44.

3) The highest priority of the device is to record the temperature via the analog input, as long as the analog input is activated as a temperature input. If the analog input is not available as a temperature input, the system attempts to record the temperature via the HART input. If both the analog input and the HART input are deactivated as a temperature input, the system uses the default density value.

... 9 Commissioning

... Devices with HART®, Modbus® or Ethernet-APL™ communication

Operating mode / order code	Designation	Additional parameters required	Parameter setting
Steam Act. Volume / NS1	Actual volume flow rate of steam	n/a	-
Steam/Water Mass (internal density determination) ⁵⁾ / NS2	Mass flow rate of steam / hot water. The calculation is done in accordance with IAPWS-IF97.	Steam type Operating pressure ^{2), 4)} Operating temperature ^{2), 3)}	Selection of steam type via: Device Setup / Plant/Customized / Compensation Setting / Water/Steam Type Via analog input: Input/Output / Field Input / Analog In Value -> Pressure Via HART input: Input/Output / Field Input / HART In Value -> Pressure Default setting for the pressure value: Device Setup / Plant/Customized / Compensation Setting -> Preset Pressure(abs) With internal temperature sensor. No information required, the measured value from the temperature sensor is used. Default setting for the temperature value: Device Setup / Plant/Customized / Compensation Setting -> Preset Int.Temp

- 2) The connection via the analog input or HART input is described in **Electrical connections** on page 44.
- 3) The highest priority of the device is to record the temperature via the analog input, as long as the analog input is activated as a temperature input. If the analog input is not available as a temperature input, the system attempts to record the temperature via the HART input. If both the analog input and the HART input are deactivated as a temperature input, the system uses the default density value.
- 4) The highest priority of the device is to record the pressure via the analog input, as long as the analog input is activated as a pressure input. If the analog input is not available as a pressure input, the system attempts to record the pressure via the HART input. If both the analog input and the HART input are deactivated as a pressure input, the system uses the default pressure value.
- 5) In order to implement the 'Steam/Water Mass' mode with internal density determination, the selection 'Calculated from...' must be set in the Device Setup / Plant/Customized / Compensation Setting -> Density Selection menu.

Operating mode / order code	Designation	Additional parameters required	Parameter setting
Steam/Water Mass (external density determination) / NS2 ⁷⁾	Mass flow rate of steam / hot water	Steam type	Selection of steam type via: Device Setup / Plant/Customized / Compensation Setting / Water/Steam Type
		Operating density ^{2), 6)}	Via analog input: Input/Output / Field Input / Analog In Value -> Density Via HART input: Input/Output / Field Input / HART In Value -> Density Default setting for the density: Device Setup / Plant/Customized / Compensation Setting -> Preset Density
Steam/Water Energy / NS3 ⁸⁾	Energy flow of steam / hot water. The calculation is done in accordance with IAPWS-IF97. ⁹⁾	Steam type	Selection of steam type via: Device Setup / Plant/Customized / Compensation Setting / Water/Steam Type
		Energy calculation	Selection of the type of energy calculation via: Device Setup / Plant/Customized / Compensation Setting Energy calc. method
		Upstream measuring medium temperature ¹⁰⁾	With internal temperature sensor. No information required, the measured value from the temperature sensor is used. Default setting for the temperature value: Device Setup / Plant/Customized / Compensation Setting -> Preset Int.Temp

2) The connection via the analog input or HART input is described in **Electrical connections** on page 44.

6) The highest priority of the device is to record the density via the analog input, as long as the analog input is activated as a density input. If the analog input is not available as a density input, the system attempts to record the density via the HART input. If both the analog input and the HART input are deactivated as a density input, the system uses the default density value.

7) In order to implement the 'Steam/Water Mass' mode with external density determination, in the Device Setup / Plant/Customized / Compensation Setting -> Density Selection menu, the selection 'Ext. Density' must be made.

8) For a detailed description of steam calculation, refer to **Energy measurement for steam / hot water in accordance with IAPWS-IF97** on page 83 ff.

9) Two different properties of steam are supported: saturated steam and overheated steam. The end user can change this in the Device Setup / Plant/Customized / Compensation Setting -> Water/Steam Type menu item.

10) Required only for net energy calculation of the actually consumed energy

... 9 Commissioning

... Devices with HART®, Modbus® or Ethernet-APL™ communication

Operating mode / order code	Designation	Additional parameters required	Parameter setting
Steam/Water Energy / NS3 ⁸⁾ (continued)	Energy flow of steam / hot water. Reverse measuring medium temperature ¹⁰⁾ The calculation is done in accordance with IAPWS-IF97. ⁹⁾		Via analog input: Input/Output / Field Input / Analog In Value -> Temperature <hr/> Via HART input: Input/Output / Field Input / HART In Value -> Temperature <hr/> Default setting for the temperature: Device Setup / Plant/Customized / Compensation Setting -> Preset Ext.Temp
		Operating pressure ^{2), 4)}	Via analog input: Input/Output / Field Input / Analog In Value -> Pressure <hr/> Via HART input: Input/Output / Field Input / HART In Value -> Pressure <hr/> Default setting for the pressure value: Device Setup / Plant/Customized / Compensation Setting -> Preset Pressure(abs)
		Operating temperature ^{2), 3)}	With internal temperature sensor. No information required, the measured value from the temperature sensor is used. <hr/> Default setting for the temperature value: Device Setup / Plant/Customized / Compensation Setting -> Preset Int.Temp

2) The connection via the analog input or HART input is described in **Electrical connections** on page 44.

3) The highest priority of the device is to record the temperature via the analog input, as long as the analog input is activated as a temperature input. If the analog input is not available as a temperature input, the system attempts to record the temperature via the HART input. If both the analog input and the HART input are deactivated as a temperature input, the system uses the default density value.

4) The highest priority of the device is to record the pressure via the analog input, as long as the analog input is activated as a pressure input. If the analog input is not available as a pressure input, the system attempts to record the pressure via the HART input. If both the analog input and the HART input are deactivated as a pressure input, the system uses the default pressure value.

8) For a detailed description of steam calculation, refer to **Energy measurement for steam / hot water in accordance with IAPWS-IF97** on page 83 ff.

9) Two different properties of steam are supported: saturated steam and overheated steam. The end user can change this in the Device Setup / Plant/Customized / Compensation Setting -> Water/Steam Type menu item.

10) Required only for net energy calculation of the actually consumed energy

... 9 Commissioning

... Devices with HART®, Modbus® or Ethernet-APL™ communication

If a pressure transmitter is not connected and steam type 'Overheated Steam' is selected, a constant pressure must be entered for the state to be detected and, if applicable, the density to be calculated.

A value must always be stored for the steam density value (constant) in the transmitter in order to define the measuring range limits for $Q_{max, DN}$ in mass flow units.

An approximation is sufficient here, the density diagrams provide an indication for determining the steam density.

Density diagrams

The following diagrams show an extract from the density table for saturated steam at different temperatures / pressures.

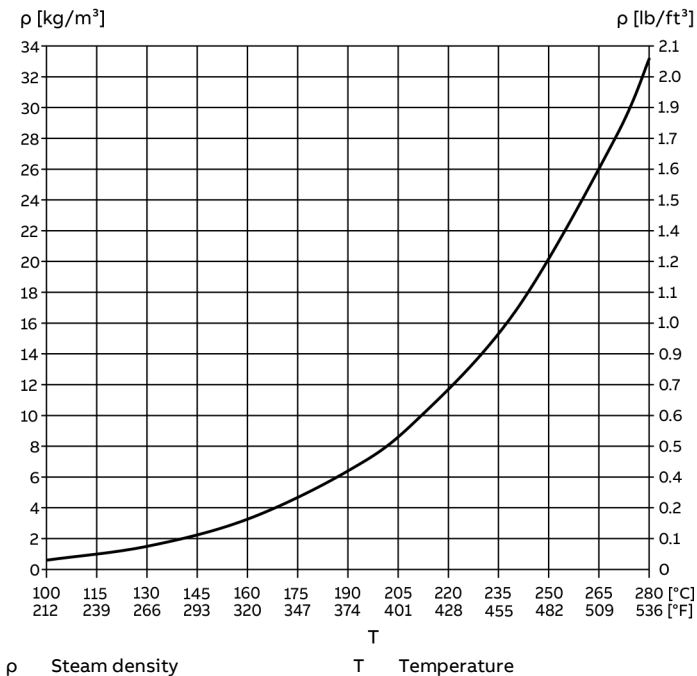

Figure 65: Saturated steam density by temperature

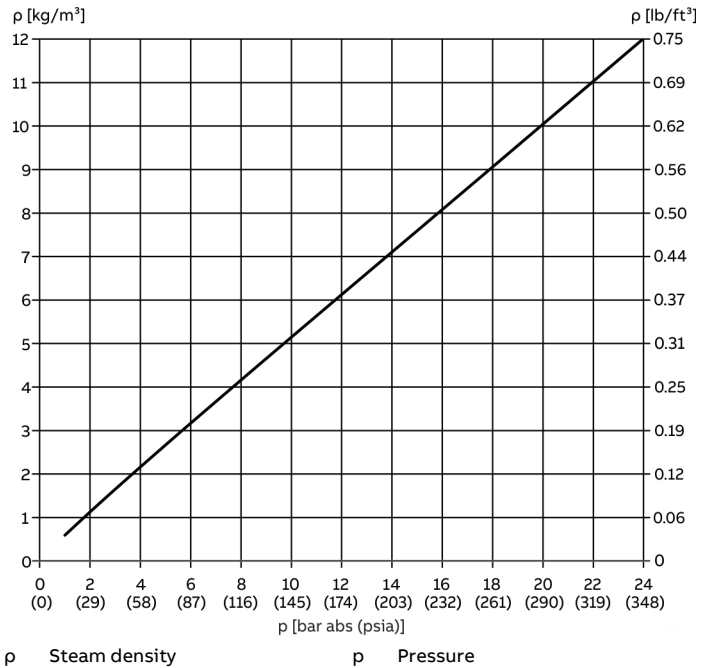
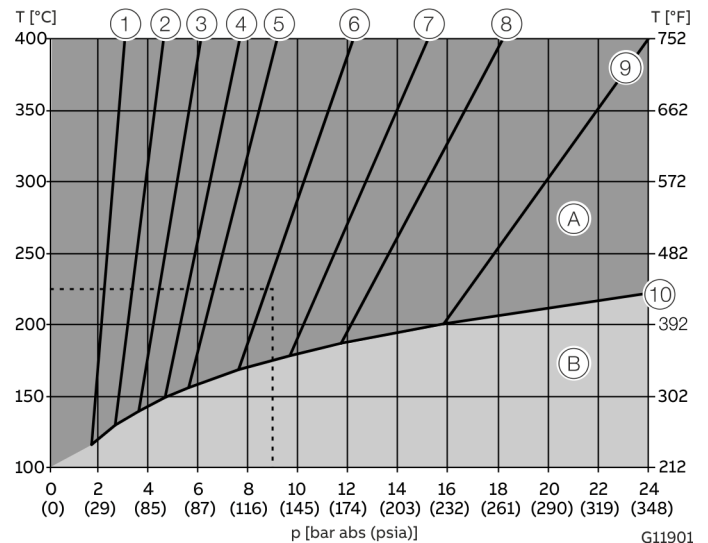

Figure 66: Saturated steam density by pressure



- (A) Hot steam zone
- (B) Saturated steam zone
- (1) 1.0 kg/m³ (0.06 lb/ft³)
- (2) 1.5 kg/m³ (0.09 lb/ft³)
- (3) 2 kg/m³ (0.12 lb/ft³)
- (4) 2.5 kg/m³ (0.16 lb/ft³)
- (5) 3 kg/m³ (0.19 lb/ft³)
- (6) 4 kg/m³ (0.25 lb/ft³)
- (7) 5 kg/m³ (0.31 lb/ft³)
- (8) 6 kg/m³ (0.37 lb/ft³)
- (9) 8 kg/m³ (0.50 lb/ft³)
- (10) Saturated steam limit

Figure 67: Steam density for hot steam

The parallel lines (1) to (9) are lines of the same density.

Application example (broken line in diagram)

Superheated steam with 225°C, 9 bar abs (437 °F, 130 psia). It yields a steam density of approx. 4.1 kg/m³ (0.26 lb/ft³).

Calculation of the density

The density calculation method is selected using the 'Density Selection' parameter.

Media type	Calculation method	Description
Saturated Steam	Calc. From T	<p>The steam density is calculated in accordance with the saturated steam curve using the measured temperature value from the internal temperature sensor.</p> <p>If using an FSS430 / FSV430 without optional internal temperature sensor, a constant (parameter 'Preset Int.Temp') must be entered for the temperature. Alternatively, an external temperature transmitter can also be connected with HART communication.</p>
	Calc. From P	<p>The steam density is calculated according to IAPWS-IF97 with a measured pressure value.</p> <p>The measured pressure value can either be supplied via the analog input, the HART input, or as a constant (parameter 'Preset Pressure(abs)').</p>
	Calc. From P&T	<p>The steam density is calculated in accordance with IAPWS-IF97 using the measured temperature value from the internal temperature sensor and a measured pressure value.</p> <p>The measured pressure value can either be supplied via the analog input, the HART input, or as a constant (parameter 'Preset Pressure(abs)').</p> <p>If using an FSS430 / FSV430 without optional internal temperature sensor, a constant (parameter 'Preset Int.Temp') must be entered for the temperature. Alternatively, an external temperature transmitter can also be connected with HART communication.</p> <ul style="list-style-type: none"> • If the steam is not saturated steam, the device issues a warning 'Wrong Steam Type'. The density and energy content of the steam is then calculated as overheated steam using the current values. • If the steam temperature is too low (wet steam), the device issues a warning 'Wrong Steam Type'. The density (and energy if necessary) is then calculated in accordance with the saturated steam curve based on the measured value of the internal or external temperature sensor. <p>If the 'Wrong Steam Type' warning is set, a status message with the steam status is additionally generated, while the time of the active status message is incremented and can be assessed.</p>
	Ext. Density	<p>The steam mass is calculated using the density value that is supplied either via the analog input, the HART input, or as a constant (parameter 'Preset Density').</p> <p>Detection of wet steam / overheated steam is not possible with this calculation method.</p>

... 9 Commissioning

... Devices with HART®, Modbus® or Ethernet-APL™ communication

Media type	Calculation method	Description
Overheated Steam	Calc. From P&T	<p>The steam density is calculated in accordance with IAPWS-IF97 using the measured temperature value from the internal temperature sensor and a measured pressure value.</p> <p>The measured pressure value can either be supplied via the analog input, the HART input, or as a constant (parameter 'Preset Pressure(abs)').</p> <p>If using an FSS430 / FSV430 without optional internal temperature sensor, a constant (parameter 'Preset Int.Temp') must be entered for the temperature. Alternatively, an external temperature transmitter can also be connected with HART communication.</p> <ul style="list-style-type: none"> If the steam temperature is too low (wet steam), the device issues a warning 'Wrong Steam Type'. The density (and energy if necessary) is then calculated in accordance with the saturated steam curve based on the measured value of the internal or external temperature sensor. <p>If the 'Wrong Steam Type' warning is set, a status message with the steam status is additionally generated, while the time of the active status message is incremented and can be assessed.</p>
	Ext. Density	<p>The steam mass is calculated using the density value that is supplied either via the analog input, the HART input, or as a constant (parameter 'Preset Density').</p> <p>Detection of wet steam / overheated steam is not possible with this calculation method.</p>
Hot Water	Calc. From T	<p>The density is calculated in accordance with IAPWS-IF97 using the measured temperature value from the internal temperature sensor.</p> <p>If using an FSS430 / FSV430 without optional internal temperature sensor, a constant (parameter 'Preset Int.Temp') must be entered for the temperature. Alternatively, an external temperature transmitter can also be connected with HART communication.</p>
	Ext. Density	<p>The hot water mass is calculated from the density.</p> <p>The density can either be supplied via the analog input, the HART input, or as a constant (parameter 'Preset Density').</p>

Note

Regardless of the media type and the calculation method, a density value must be entered in the 'Device Setup / Plant/Customized / Compensation Setting / Preset Density' menu to determine the max. measuring range limits.

- The entered density will not be used for compensation purposes.
- The entered density should be calculated in accordance with the typical (maximum) operating conditions.

10 Operation

Safety instructions

CAUTION

Risk of burns due to hot measuring media

The device surface temperature may exceed 70 °C (158 °F), depending on the measuring medium temperature!

- Before starting work on the device, make sure that it has cooled sufficiently.

If there is a chance that safe operation is no longer possible, take the device out of operation and secure it against unintended startup.

Account and password

The HART and Modbus products support two access account, one is ABB service account, the other is standard account.

- ABB service account
This account can be disabled in standard account.
- Standard account
For security reasons it is recommended, to set a password. When changing a password, record it somewhere secure. If a password is lost or unknown, it must be reset to the factory or format NV, then it will change to default status.

Parameterization of the device

The LCD indicator has capacitive operating buttons. These enable you to control the device through the closed housing cover.

Note

The transmitter automatically calibrates the capacitive buttons on a regular basis. If the cover is opened during operation, the sensitivity of the buttons is firstly increased to enable operating errors to occur. The button sensitivity will return to normal during the next automatic calibration.

Menu navigation

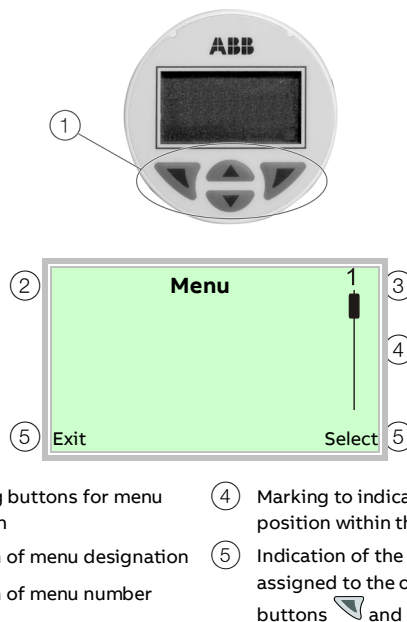

- ① Operating buttons for menu navigation
- ② Indication of menu designation
- ③ Indication of menu number
- ④ Marking to indicate relative position within the menu
- ⑤ Indication of the current function assigned to the operating buttons and

Figure 68: LCD indicator (example)

You can use the or operating buttons to browse through the menu or select a number or character within a parameter value.

Different functions can be assigned to the and operating buttons. The function that is currently assigned (⑤) is shown on the LCD display.

Operating button functions

	Meaning
Exit	Exit menu
Back	Go back one submenu
Cancel	Cancel parameter entry
Next	Select the next position for entering numerical and alphanumeric values

	Meaning
Select	Select submenu / parameter
Edit	Edit parameter
OK	Save parameter entered

... 10Operation

... Parameterization of the device

Menu navigation – SmartHMI

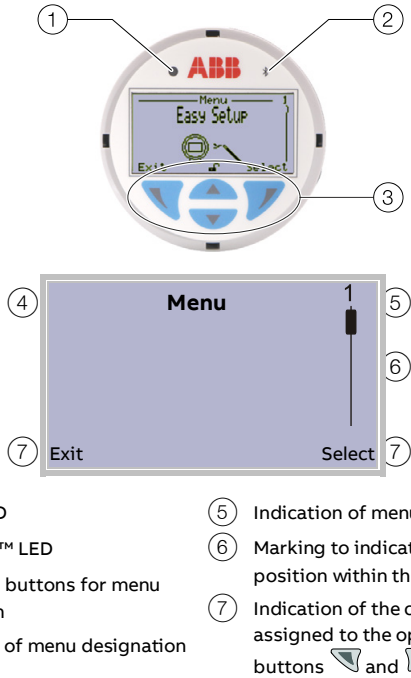

- ① Status LED
- ② Bluetooth™ LED
- ③ Operating buttons for menu navigation
- ④ Indication of menu designation
- ⑤ Indication of menu number
- ⑥ Marking to indicate relative position within the menu
- ⑦ Indication of the current function assigned to the operating buttons and

Figure 69: SmartHMI LCD indicator (example)

You can use the or operating buttons to browse through the menu or select a number or character within a parameter value.

Different functions can be assigned to the and operating buttons. The function that is currently assigned (⑦) is shown on the LCD display.

Status LED functions

The status LED uses different colors to indicate the NAMUR status and the status of the digital output.

LED colour	Meaning
	Lights up red Namur status 'Failure'
	Flashes red Namur status 'Check function'
	Flashes red Namur status 'Out of specification'
	Flashes green / Lights up blue Namur status 'Maintenance required'
	Lights up green Normal operation
	Lights up yellow Digital output active

Bluetooth™ LED functions

The Bluetooth LED indicates the status of the Bluetooth connection of the SmartHMI.

LED colour	Meaning
	Off Bluetooth deactivated
	Lights up blue Bluetooth active and connected to a device
	Flashes blue Bluetooth active and no device connected

Operating button functions

Meaning	Meaning
	Exit menu
	Go back one submenu
	Cancel parameter entry
	Select the next position for entering numerical and alphanumeric values

Meaning	Meaning
	Select submenu / parameter
	Edit parameter
	Save parameter entered

Note

For detailed information on connecting to the ABB “My Device Manager”, see **Parameterization via My Device Manager mobile app** on page 72.

Bluetooth connection process

The first time when a phone, tablet or PC will be connected to a device with Smart HMI, the devices need to be paired. This pairing process need to be done one time only, after that the devices will reconnect automatically when the smart phone, tablet or PC is getting inside the range of the Bluetooth.

In the Pairing Process, the Bluetooth LED flashes and the SmartHMI as Bluetooth slave will request a 'Pairing key' from a PC, tablet or Phone as Bluetooth Master. The user can input the pairing key by PC or Phone and the SmartHMI will check it.

If the pairing is succeeded, Master and Slave will exchange their Bluetooth configuration and negotiate a communication standard automatically.

NOTICE

Effect on the current output in pairing mode

Devices with HART communication (output signal H1 or H5) will set the current output to 22 mA high alarm current in the pairing mode.

- Make sure to disconnect the device from the control loop before starting the pairing mode!

Note

- One PC or Phone (Master) can connect with several SmartHMIs (Slave) at same time.
- One SmartHMI (Slave) can only connect with one PC or Phone (Master) at same time.
- If Bluetooth is enabled, the SmartHMI will do Bluetooth advertising when no Master Device is connected to Smart HMI.

... 10Operation

... Parameterization of the device



SmartHMI Unit Setup menu

The 'SmartHMI Unit Setup' menu is designed for specific HMI configurations like backlight or Bluetooth.

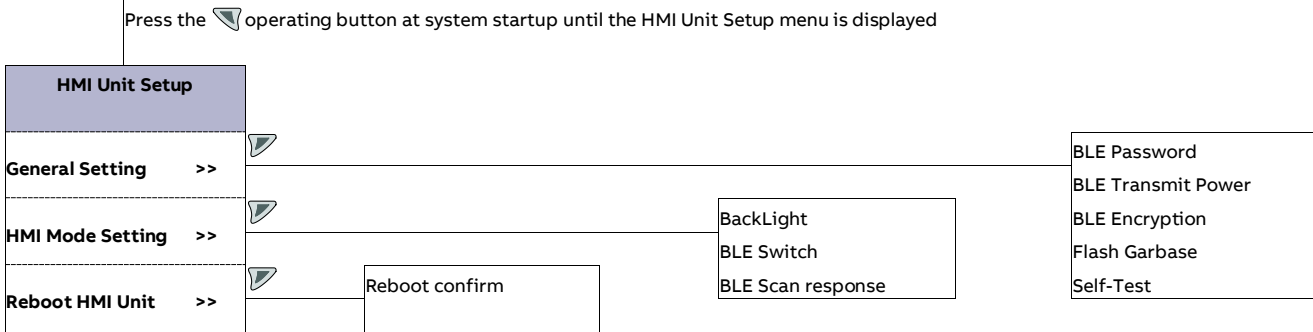
To enter the 'SmartHMI Unit Setup' keep pressing SmartHMI left button before device startup and do not release until HMI unit setup menu is displayed.



Menu description

Menu / parameter	Description
HMI Unit Setup	
General Setting >>	Selection of submenu 'General Setting' using  .
HMI Mode Setting >>	Selection of submenu 'HMI Mode Setting' using  .
Reboot HMI Unit >>	Selection of submenu 'Reboot HMI Unit' using  .

HMI Unit Setup / General Setting

BLE Password	Change Bluetooth pairing password, set password as default '123456', or generate a new one.
BLE Transmit Power	Set Bluetooth transmit power to 0db/4db/8db for option, higher power level, better Bluetooth signal and more power consumption.
BLE Encryption	Enable or disable Bluetooth packet data encryption, or AUTO (decided by system).
Flash Garbage	Clean nonvolatile memory
Self-test	SmartHMI hardware test, same with FCT to check any hardware fault.

HMI Unit Setup / HMI Mode Setting

Backlight	Change Bluetooth pairing password, set password as default '123456', or generate a new one.
BLE Switch	Set Bluetooth transmit power to 0db/4db/8db for option, higher power level, better Bluetooth signal and more power consumption.
BLE Scan response	Enable or disable SmartHMI Bluetooth data packet scan response data.

HMI Unit Setup / Reboot HMI Unit

Reboot Confirm	Exit menu and save all settings, must reboot confirm otherwise settings will not save and change!
----------------	---

Menu levels

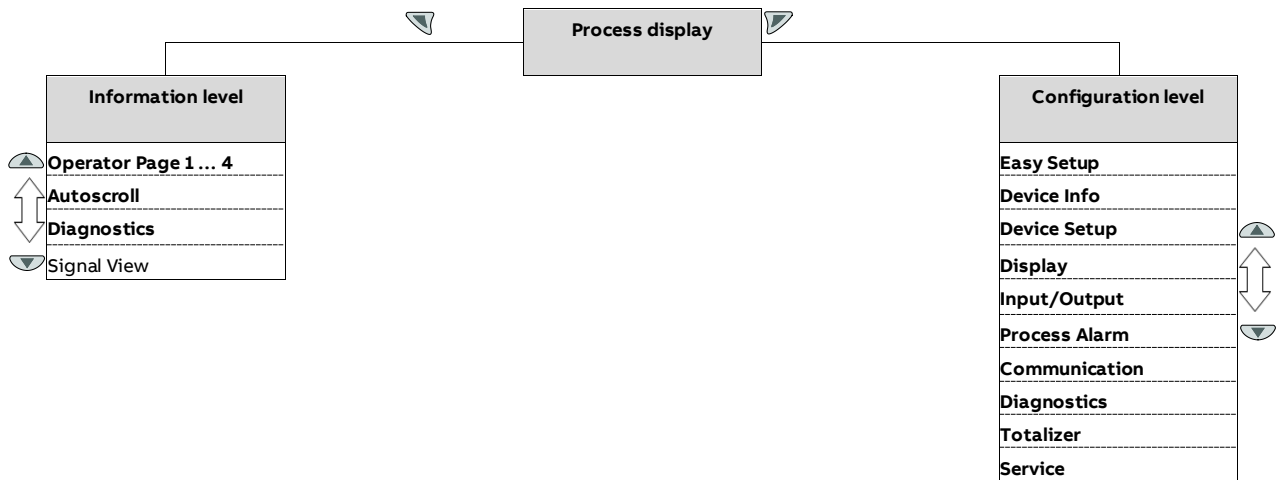

Process display

The process display shows the current process values.
There are two menu levels under the process display.

Information level (Operator Menu)

The information level contains the parameters and information that are relevant for the operator.
The device configuration cannot be changed on this level.

Configuration level (Configuration)

The configuration level contains all the parameters required for device commissioning and configuration. The device configuration can be changed on this level. For detailed information on the parameters, refer to **Parameter descriptions** on page 106.

Note

With the hardware write protection activated (see **DIP switch on the HART® communication board** on page 64, **DIP switch on the PROFIBUS PA®- / FOUNDATION Fieldbus® communication board** on page 68 or **DIP switch on the PROFIBUS PA®- / FOUNDATION Fieldbus® communication board** on page 68), the device configuration can no longer be changed using the LCD indicator or the Fieldbus interface. By activating the hardware write protection and sealing the respective DIP switches, the device can be protected against unauthorized changes to the device configuration.

... 10Operation

Process display

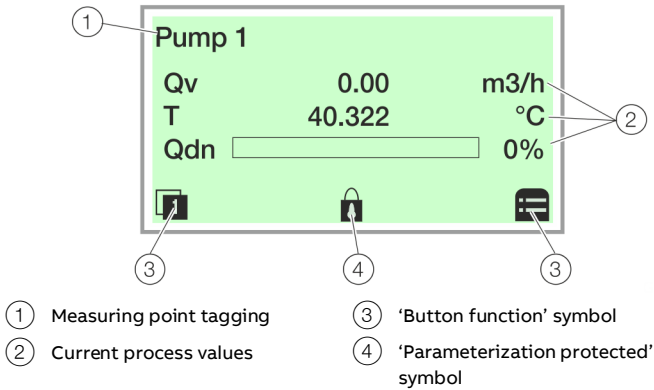









Figure 70: Process display (example)

The process display appears on the LCD display when the device is powered on. It shows information about the device and current process values.

The way in which the current process values are shown can be adjusted on the configuration level.

The symbols at the bottom of the process display are used to indicate the functions of the operating buttons  and , in addition to other information.

Symbol	Description
	Call up information level.
	When Autoscroll mode is activated, the  icon appears here and the operator pages are automatically displayed one after the other.
	Call up configuration level.
	The device is protected against changes in the parametrization.

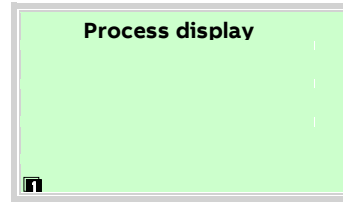

Switching to the information level (operator menu)

On the information level, the operator menu can be used to display diagnostic information and choose which operator pages to display.

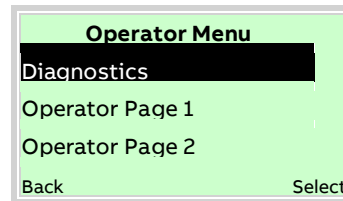

1. Open the  using Operator Menu.



2. Select the desired submenu using  / .
3. Confirm the selection with .

Menu	Description
... / Operator Menu	
Diagnostics	Selection of sub-menu 'Diagnostics'; see also Error messages on the LCD display on page 95.
Operator Page 1 to n	Selection of operator page to be displayed.
Autoscroll	When 'Autoscroll' is activated, automatic switching of the operator pages is initiated on the process screen.
Signal view	Selection of submenu 'Signal view' (only for service purposes).

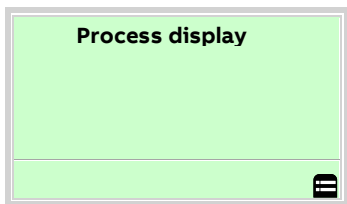

Switching to the configuration level (parameterization)

The device parameters can be displayed and changed on the configuration level.

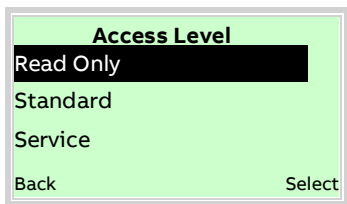

1. Switch to the configuration level with .



2. Select the desired level of access using  / .
3. Confirm the selection with .

Note

There are three levels of access. A password can be defined for level 'Standard'. There is no factory default password. For security reasons it is recommended, to set a password.

Access Level	Description
Read Only	All parameters are locked. Parameters are read only and cannot be modified.
Standard	All the parameters can be altered.
Service	Only Customer Service has access to the Service menu.

Once you have logged on to the corresponding access level, you can edit or reset the password.

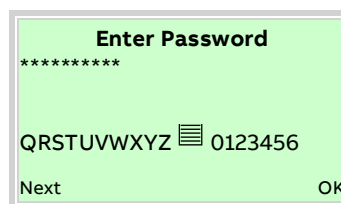

Reset (status 'no password defined') by selecting '☰' as a password.

The newly assigned password is not valid until you log out from the 'Standard'.



4. Enter the corresponding password (see **Selecting and changing parameters** on page 94). No password is preset in the factory settings. Users can switch to the configuration level without entering a password. The selected access level remains active for 3 minutes. Within this time period you can toggle between the process display and the configuration level without re-entering the password.
5. Use  to confirm the password.

The LCD display now indicates the first menu item on the configuration level.

6. Select a menu using  / .
7. Confirm the selection with .

... 10Operation

Selecting and changing parameters

Entry from table

When an entry is made from a table, a value is selected from a list of parameter values.

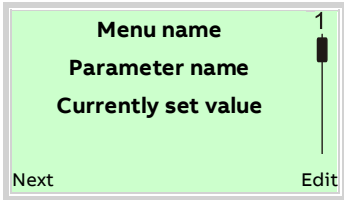

1. Select the parameters you want to set in the menu.
2. Use to call up the list of available parameter values. The parameter value that is currently set is highlighted.

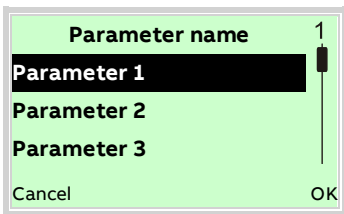

3. Select the desired value using / .
4. Confirm the selection with .

This concludes the procedure for selecting a parameter value.

Numerical entry

When a numerical entry is made, a value is set by entering the individual decimal positions.

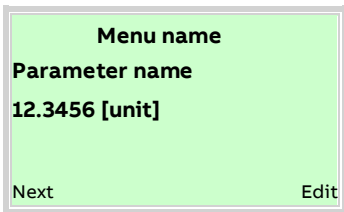

1. Select the parameters you want to set in the menu.
2. Use to call up the parameter for editing. The decimal place that is currently selected is highlighted.

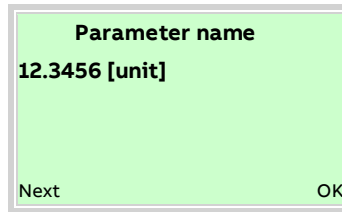

3. Use to select the decimal place to change.
4. Use / to set the desired value.
5. Use to select the next decimal place.
6. If necessary select and set additional decimal places in accordance with steps 3 to 4.
7. Use to confirm your setting.

This concludes the procedure for changing a parameter value.

Alphanumeric entry

When an alphanumeric entry is made, a value is set by entering the individual decimal positions.

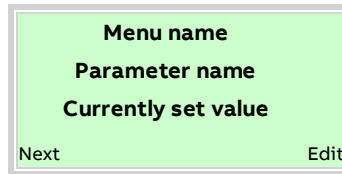

1. Select the parameters you want to set in the menu.
2. Use to call up the parameter for editing. The decimal place that is currently selected is highlighted.

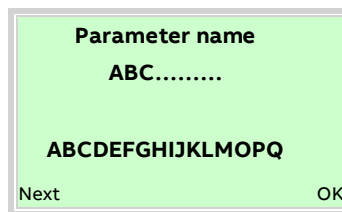

3. Use to select the decimal place to change.
4. Use / to set the desired value.
5. Use to select the next decimal place.
6. If necessary select and set additional decimal places in accordance with steps 3 to 4.
7. Use to confirm your setting.

This concludes the procedure for changing a parameter value.



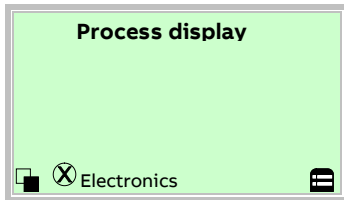

Error messages on the LCD display

In the event of an error, a message consisting of a symbol and text (e.g. Electronics) appears at the bottom of the process screen.

The text displayed provides information about the area in which the error has occurred.



The error messages are divided into four groups in accordance with the NAMUR classification scheme. The group assignment can only be changed using a DTM or EDD:

Symbol	Description
	Error / failure
	Function check
	Outside of the specification
	Maintenance required

The error messages are also divided into the following areas:

Range	Description
Fonctionnement	Error / alarm due to the current operating conditions.
Sensor	Error / alarm of the flowmeter sensor.
Electronics	Error / alarm of the electronics.
Configuration	Error / alarm due to device configuration.

Note

For a detailed description of errors and troubleshooting instructions, please see **Diagnosis / error messages** on page 136.

... 10Operation

Parameter overview

Note

This overview of parameters shows all the menus and parameters available on the device. Depending on the version and configuration of the device, not all of the menus and parameters may be visible in it.

The various operating modes have different menu displays. In this overview, menus are marked with numbers that appear only in certain operating modes.

Operating modes*

1 Liquid Mass	5 Gas Std/Norm Vol.
2 Liquid Volume	10 Gas Act. Volume
3 Gas Mass	12 Steam Act. Volume
4 Steam/Water Mass	13 Steam/Water Energy

Easy Setup

Language

Active Mode* / Medium Type**

Current Out

DO Function

Pulses Per Unit

Pulse Width

Lower Frequency

Upper Frequency

Logic on DO

Unit Qv

Unit Qm ^{1,3,4}

Unit Qn

Unit Qpower

Unit Density ^{1,3,4}

Unit Temperature

Unit Pressure ^{3,4,5}

Unit Volume

Unit Mass

Unit Std/Norm Vol.

Unit Energy

HART In Value

Analog In Value

T Ext. Upper Range ^{1,4,5}

T Ext. Lower Range ^{1,3,4,5}

Pressure Upper Range

Pressure Lower Range

P(abs) Upper Range

P(abs) Lower Range

Continued on next page

* Only for devices with HART® or Modbus® communication.

** Only for devices with PROFIBUS® or FOUNDATION Fieldbus® communication.

Continued
Density Upper Range
Density Lower Range
Ext.Cutoff Trigger
Gas Density Selec.
Gas Ref. Conditions^{3,5}
Water/Steam Type⁴
Density Selection
Energy calc. method
Ref. Density^{1,3}
Preset Density^{1,3,4}
Ref. Temperature^{1,3}
Preset Int.Temp^{1,3,4,5}
Preset Ext.Temp
Preset Pressure(abs)</v>^{3,4,5}
Qvmax
QnMax^{3,5}
QmMax^{3,4}
QpowerMax
Damping Qv
Damping Qn^{1,3,5}
Damping Qm^{3,4}
Damping Qpower
Temp->l=0%
Damping Temperature
Iout at Alarm
Low Alarm Value
High Alarm Value
Auto Zero
Low Flow Cutoff

... 10Operation

... Parameter overview

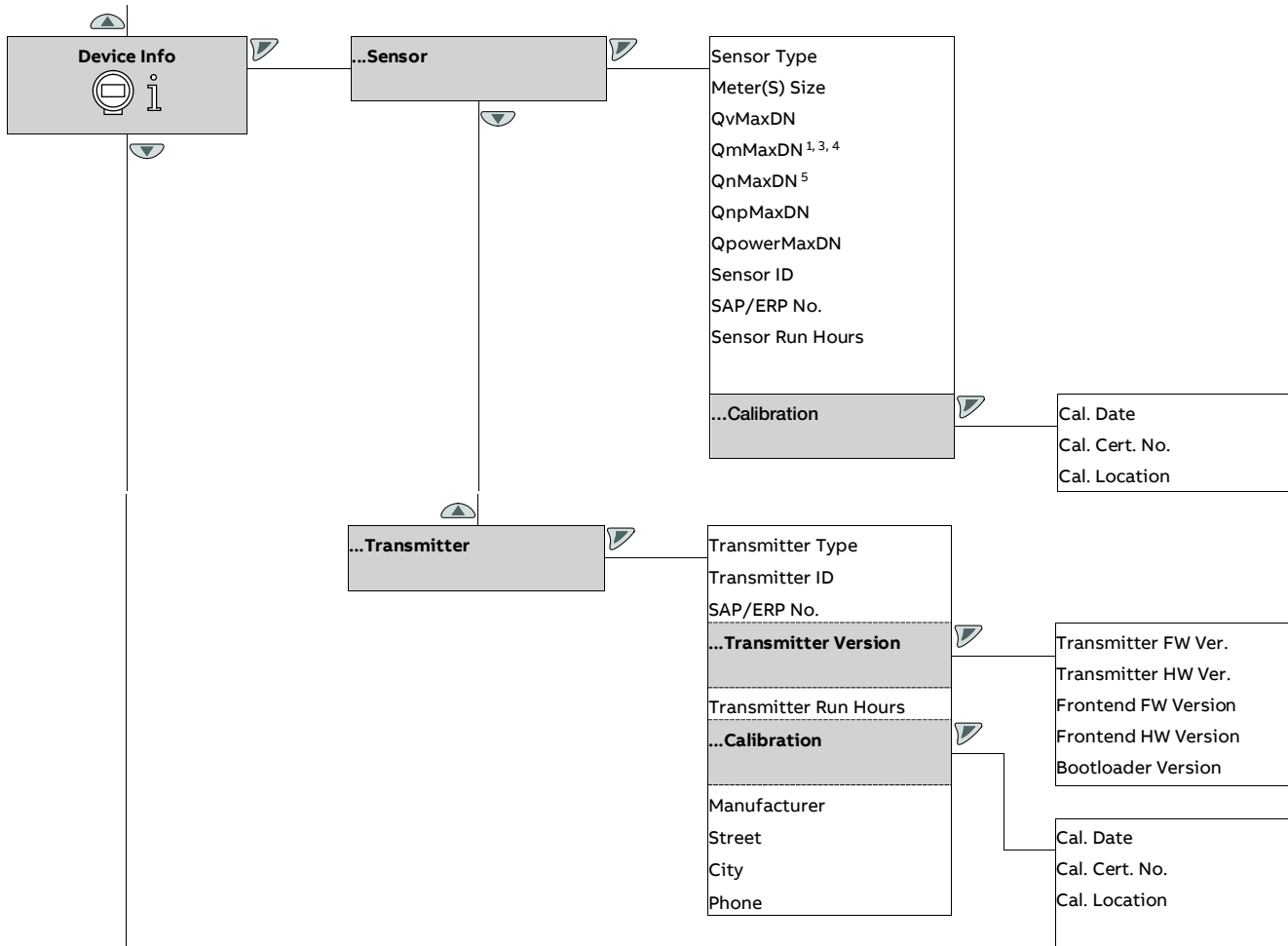

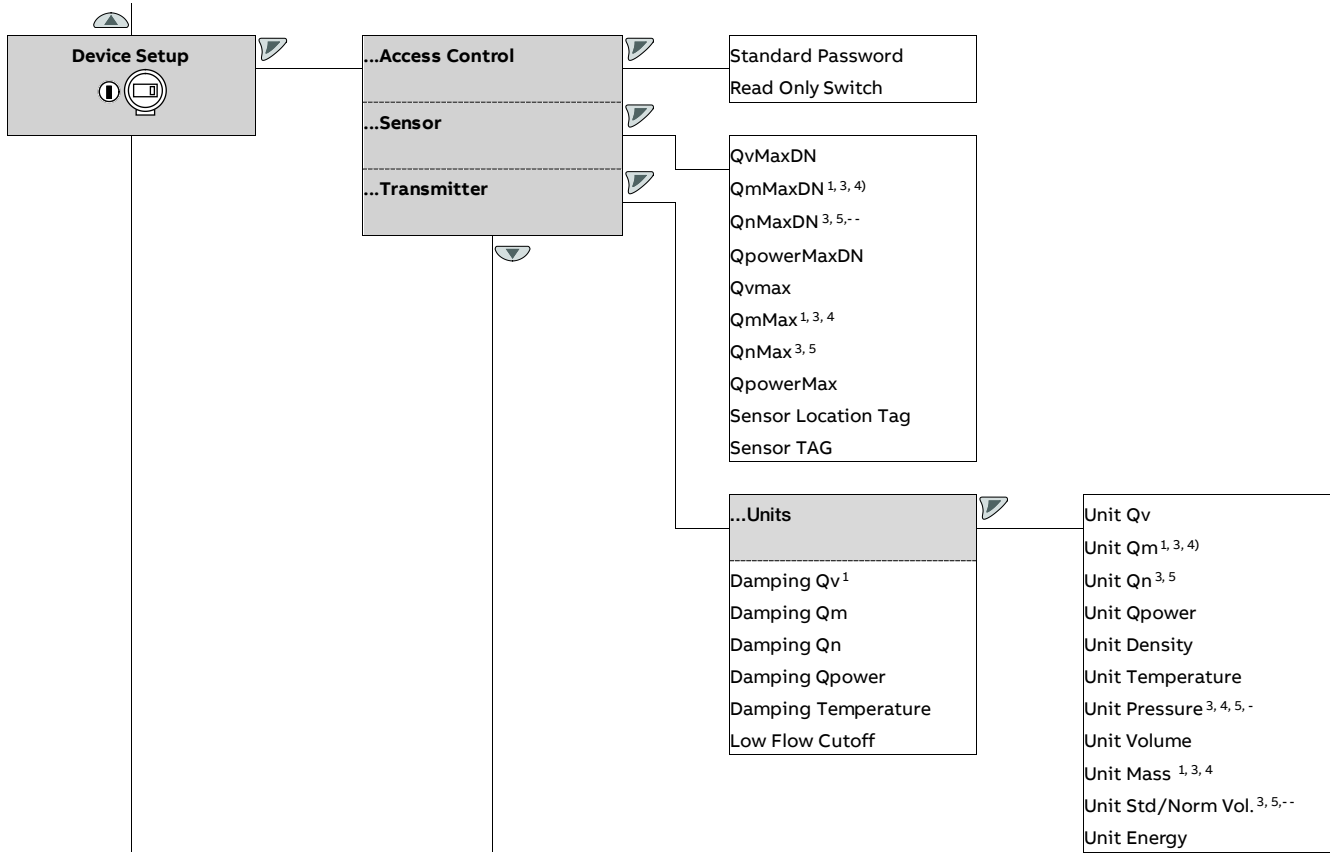

... 10Operation

... Parameter overview

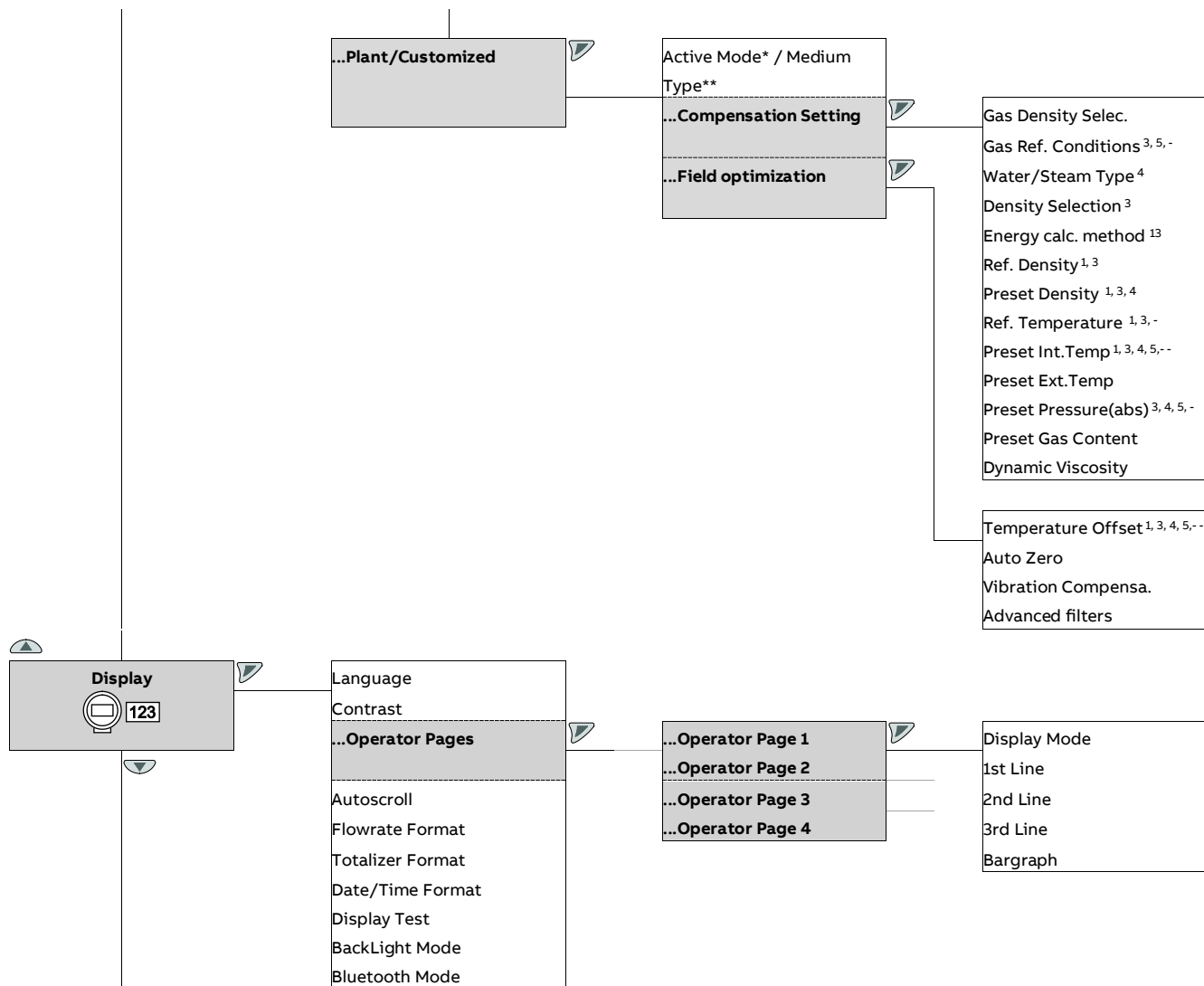

* Only for devices with HART® or Modbus® communication.

** Only for devices with PROFIBUS® or FOUNDATION Fieldbus® communication.

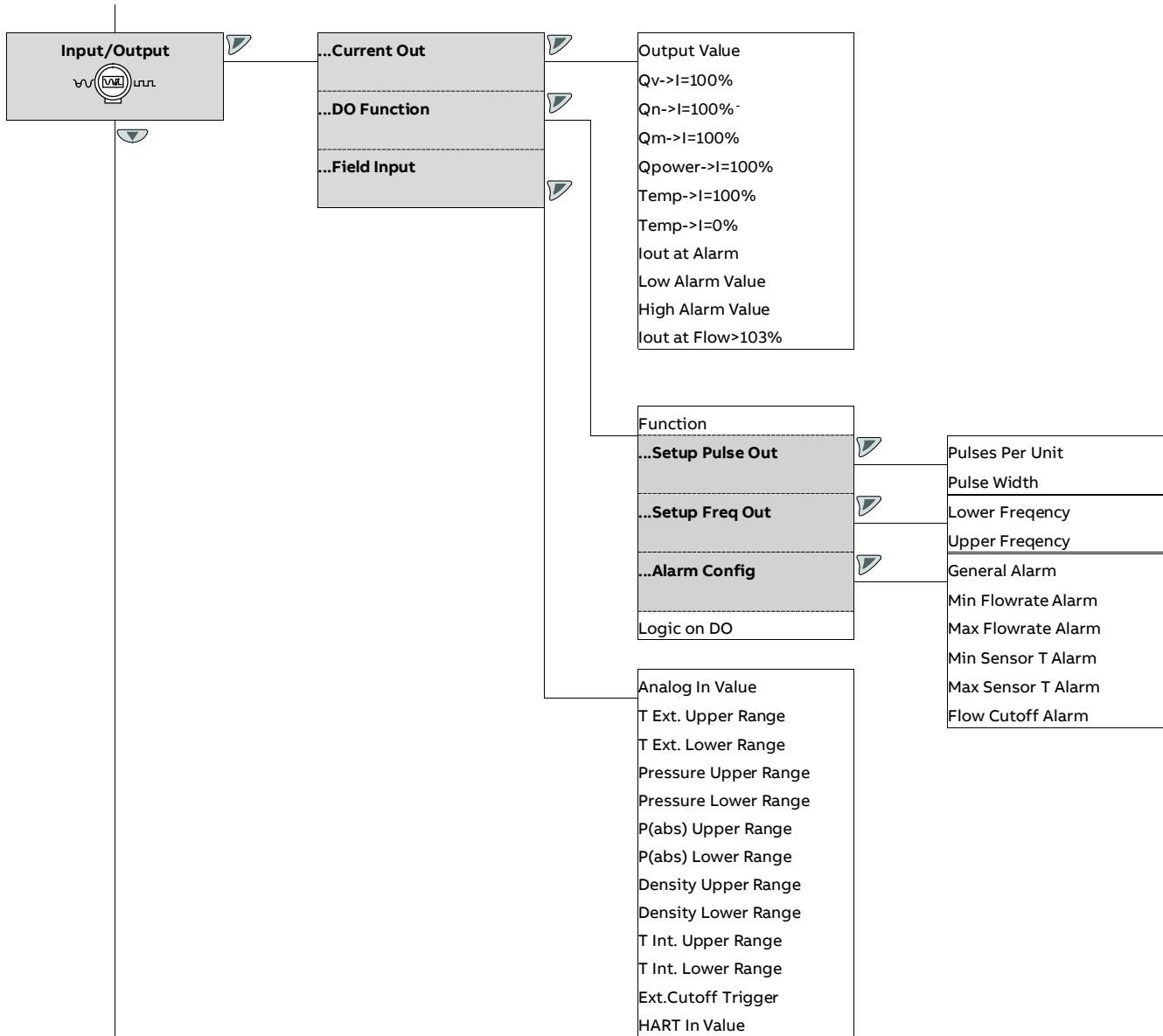

... 10Operation

... Parameter overview

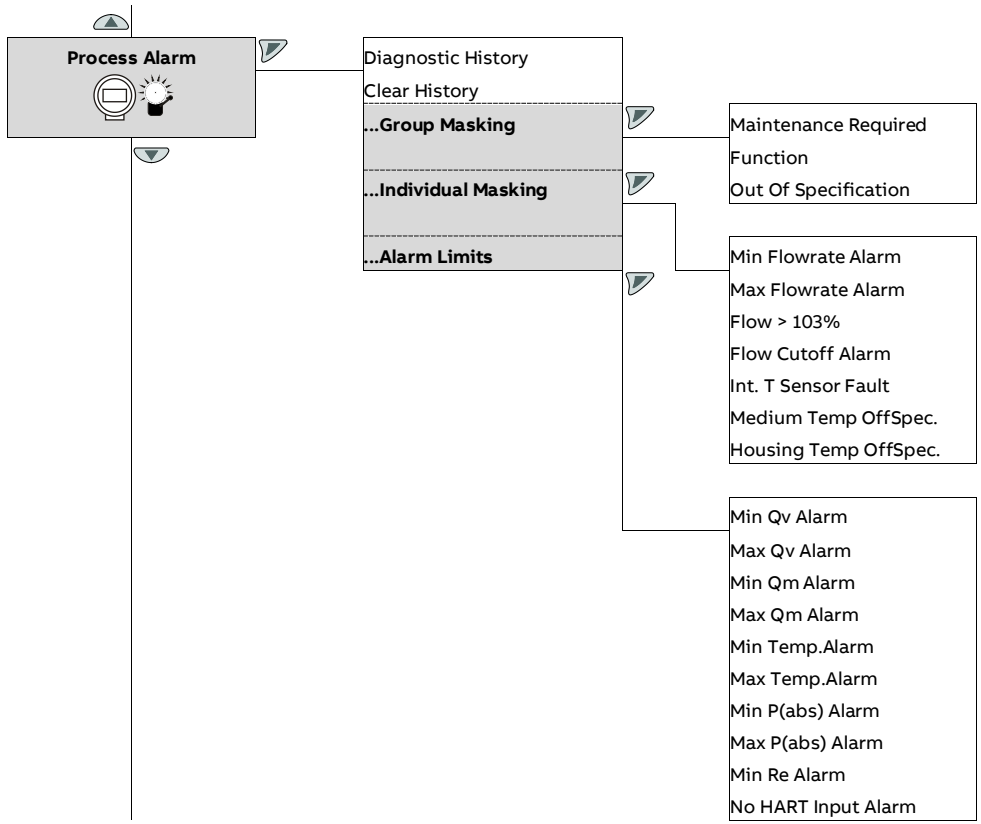

Note

The menu Communication depends on the device design.

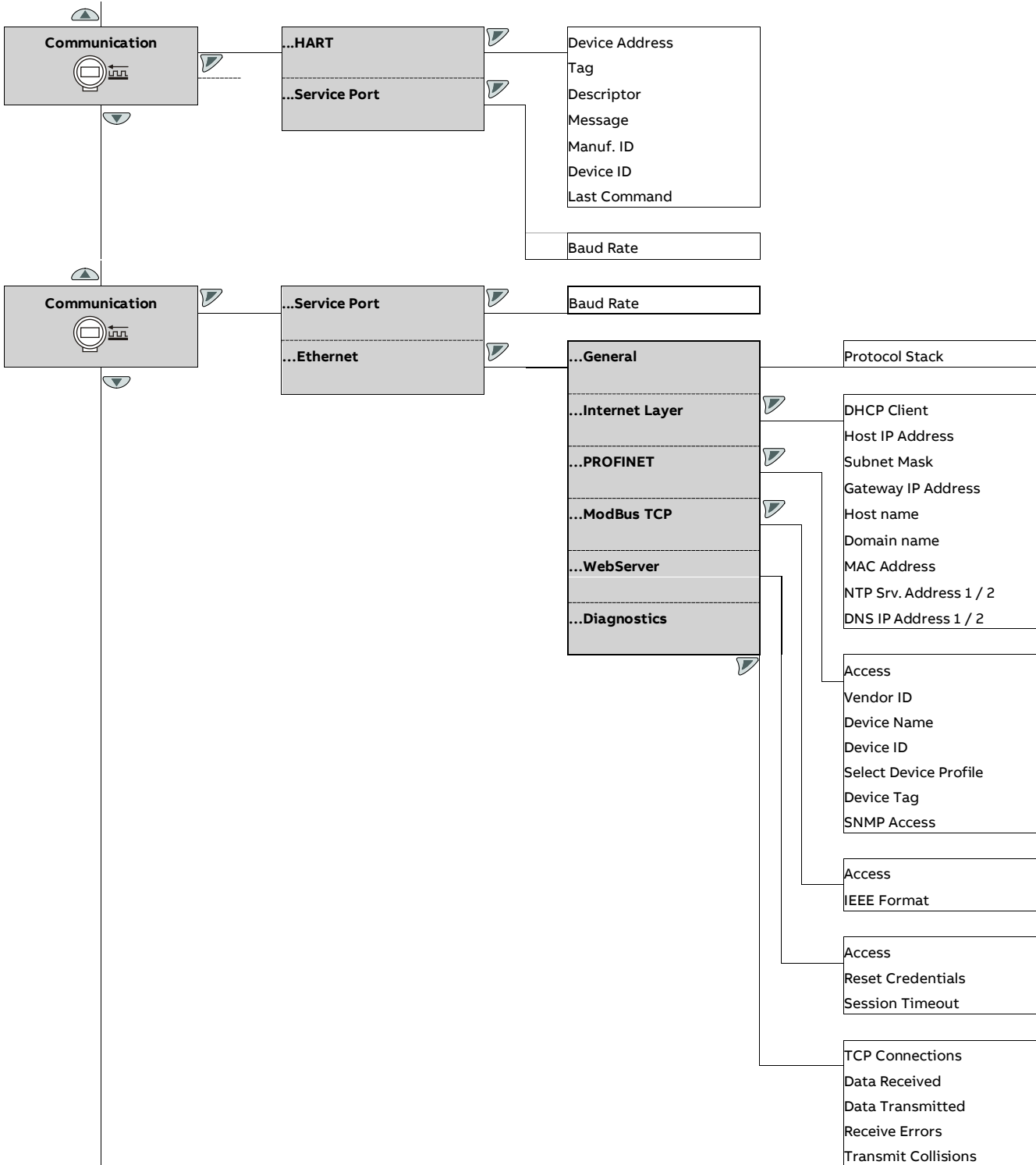

... 10Operation

... Parameter overview

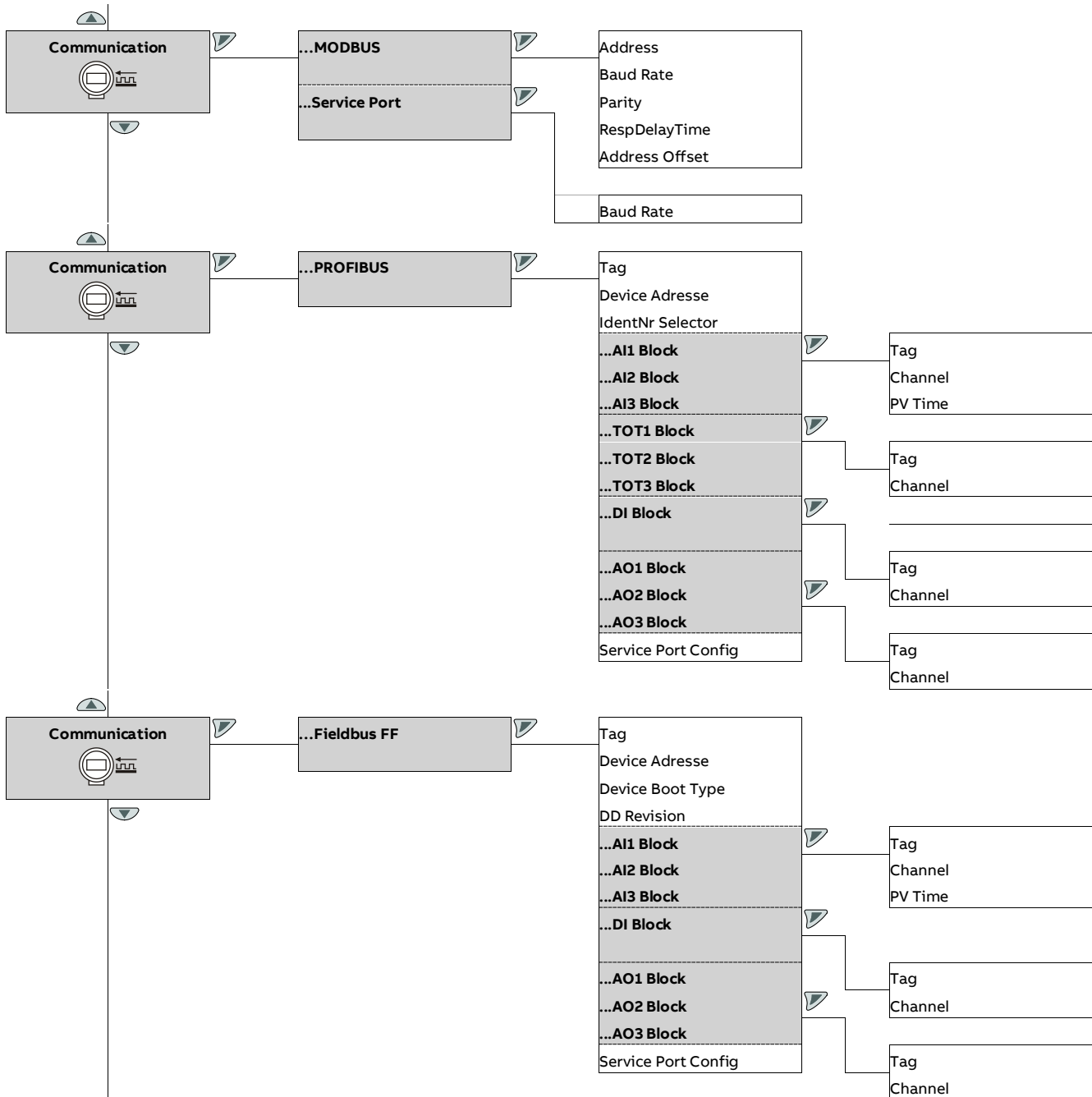

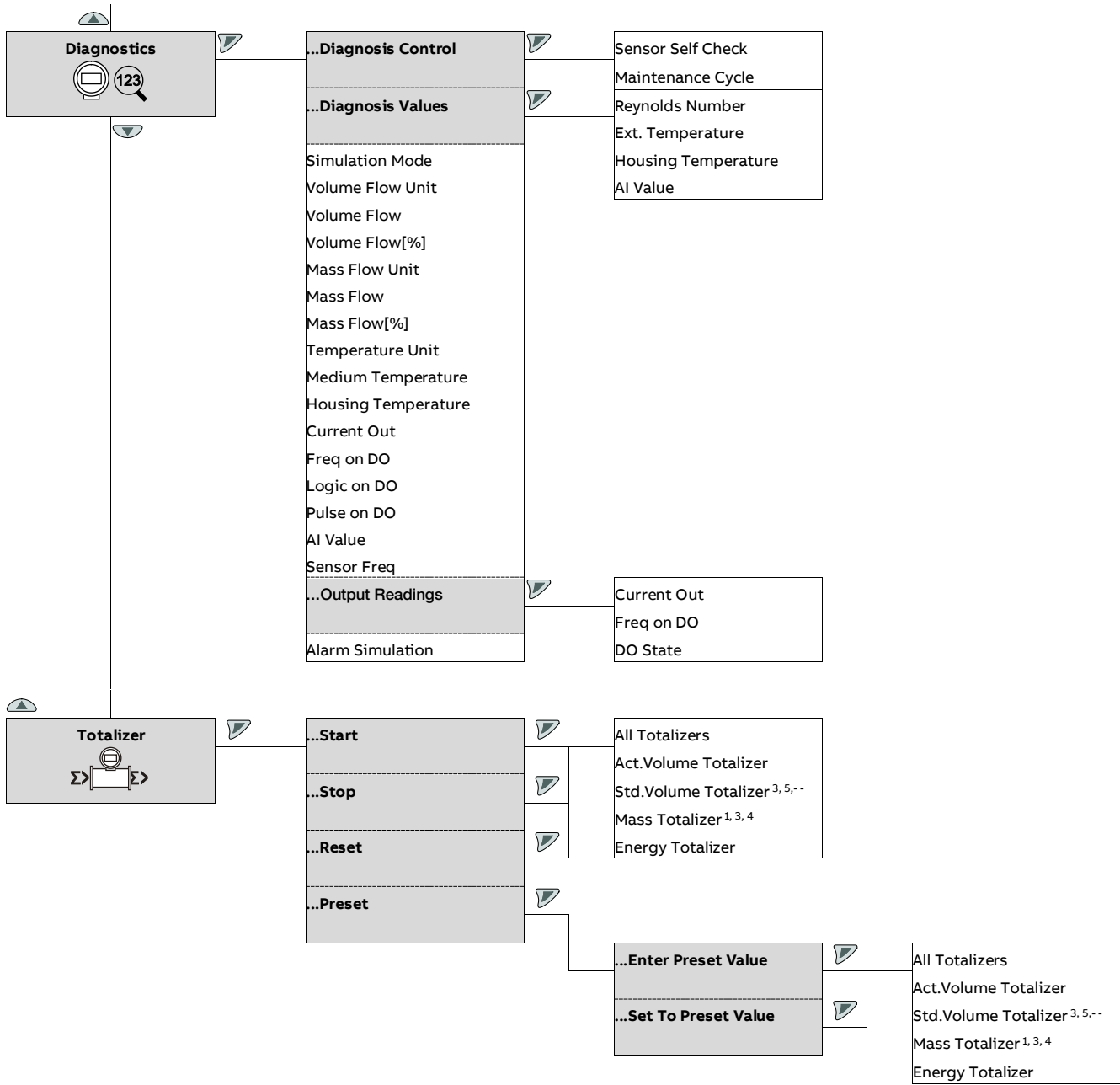

... 10Operation

Parameter descriptions

Note

This overview of parameters shows all the menus and parameters available on the device. Depending on the version and configuration of the device, not all of the menus and parameters may be visible in it.

Menu: Easy Setup

Menu / parameter	Description
Easy Setup	
Language	Selection of menu language.
Active Mode	Selection of operating mode (only for devices with HART® or Modbus® communication). See Operating modes on page 78 for further information.
Medium Type	Selection of the measuring medium type (only for devices with PROFIBUS® or FOUNDATION Fieldbus® communication). <ul style="list-style-type: none"> Liquid: Liquid measuring media Gas: Gaseous measuring media Steam: Steam as a measuring medium
Output Value	Selection of the process variable issued at the current output. <ul style="list-style-type: none"> Q: Flow T: Temperature
DO Function	Selection of the function for the digital output (not for devices with FOUNDATION Fieldbus® communication). <ul style="list-style-type: none"> None: Digital output deactivated. Logic on DO: Digital output as a binary output (e.g. as an alarm output). Pulse on DO: Digital output DO1 as a pulse output. In pulse mode, pulses are output per unit (e.g. 1 pulse per m3) Freq on DO: Digital output DO1 as a frequency output. In frequency mode, a frequency is issued that is proportional to the flow rate. The maximum frequency can be configured in accordance with the upper range value.
Pulses Per Unit	Setting of the pulses per unit of the selected operating mode and pulse width for the 'Pulse on DO' function of the digital output.
Pulse Width	Available only if the digital output has been configured as a pulse output.
Lower Frequency	Setting of the frequency range for the 'Freq on DO' function of the digital output.
Upper Frequency	Available only if the digital output has been configured as a frequency output.
Logic on DO	Select switching properties for the binary output. <ul style="list-style-type: none"> Normally Closed: Binary output to open a normally closed contact. Normally Open: Binary output to close a normally open contact.
Unit Qv	Selection of unit for volume flow. m ³ /s, m ³ /min, m ³ /h, m ³ /d, ft ³ /s, ft ³ /min, ft ³ /h, ft ³ /d, l/s, l/min, l/h, l/d, USgal/s, USgal/min, USgal/h, USgal/d, impgal/s, impgal/min, impgal/h, impgal/d, bbl/s, bbl/min, bbl/h, bbl/d, Mft ³ /s, M ft ³ /min, M ft ³ /h, M ft ³ /day, MM ft ³ /s, MM ft ³ /min, MM ft ³ /h, MM ft ³ /day Factory setting: l/min
Unit Qm	Selection of unit for mass flow. g/s, g/min, g/h, kg/s, kg/min, kg/h, kg/d, t/s, t/min, t/h, t/d, lb/s, lb/min, lb/h, lb/d, US t/s, US t/min, US t/h, US t/d
Unit Qn	Selection of unit for the standard volume flow. m ³ /s, m ³ /min, m ³ /h, m ³ /d, ft ³ /s, ft ³ /min, ft ³ /h, ft ³ /d, kft ³ /s, kft ³ /min, kft ³ /h, kft ³ /d, l/s, l/min, l/h, l/d, Mft ³ /s, M ft ³ /min, M ft ³ /h, M ft ³ /day, MM ft ³ /s, MM ft ³ /min, MM ft ³ /h, MM ft ³ /day Factory setting: l/min
Unit Qpower	Selection of unit for energy measurement. W, MW, kW, kJ/s, kJ/min, kJ/h, kJ/d, MJ/h, BTU/s, BTU/min, BTU/h, BTU/d, MBTU/min, MBTU/h, MBTU/d, MMBTU/h, MMBTU/d, MJ/s, MJ/min, MJ/d, MBTU/s, MMBTU/s, MMBTU/min

Menu / parameter	Description
Easy Setup	
Unit Density	Selection of unit for density. kg/m ³ , g/cm ³ , kg/l, g/ml, g/l, lb/in ³ , lb/ft ³
Unit Temperature	Selection of unit for temperature. kelvin, celsius, fahrenheit
Unit Pressure	Selection of unit for pressure measurement. Pa, MPa, KPa, HPa, bar, mbar, mm H ₂ O, psi, kg/cm ³
Unit Volume	Selection of unit for the volume totalizer. m ³ , ft ³ , l, imp gal, US gal, bbl, Mft ³ , MMft ³
Unit Mass	Selection of unit for the mass counter. g, kg, t, lb, US t
Unit Std/Norm Vol.	Selection of unit for the standard volume totalizer. m ³ , ft ³ , l, imp gal, US gal, bbl, Mft, MMft
Unit Energy	Selection of unit for the energy counter. J, kJ, MJ, BTU, MMBTU, Wh, MWh, kWh, MBTU
HART In Value	Selection of the process variables measured via the HART input (only for devices with HART® communication). <ul style="list-style-type: none"> • None: No remote transmitter at the input. • Temperature: Remote temperature transmitter at the input (transmitter in the reverse flow of a heating or cooling cycle for net energy calculation or transmitter in the device outlet (see Installation for external pressure and temperature measurement on page 37) for temperature compensation, if no internal temperature measurement is possible / desired). • Pressure: Remote pressure transmitter at the input. • Pressure(abs): Remote absolute pressure transmitter at the input. • Density: Remote transmitter at the input. • Int.T: External temperature transmitter, e.g. for using a remote temperature transmitter instead of the internal temperature sensor to increase the accuracy or reduce the response time. Refer to HART® communication with remote transmitter on page 51.
Analog In Value	Selection of the process variables measured via the analog input (only for devices with HART® communication). For description, see parameter "HART In Value". Refer to Analog input 4 to 20 mA on page 64.
T Ext. Upper Range	Setting of the measuring range limits for the external transmitter at the analog input.
T Ext. Lower Range	The upper value applies for a current of 20 mA at the analog input, the lower value for a current of 4 mA.
Pressure Upper Range	The availability of this parameter depends on the process variable selected for the analog input.
Pressure Lower Range	
P(abs) Upper Range	
P(abs) Lower Range	
Density Upper Range	
Density Lower Range	

... 10Operation

... Parameter descriptions

Menu / parameter	Description
Easy Setup	
Ext.Cutoff Trigger	<p>Selection of the switching point for externally switching off the output via the analog input.</p> <p>If the switching point is exceeded, the flow measurement is set to zero.</p> <p>Possible switching points: > 4 mA, > 8 mA, > 12 mA</p>
Gas Density Selec.	<p>Selection of the density source for gas mass measurement in operating mode 'Gas Mass'.</p> <ul style="list-style-type: none"> • Ref. Density: Gas mass flow, calculated using pressure, temperature, and density under reference conditions. • Act. Density: Gas mass flow, calculated using the current density in the operating condition. <p>See Operating modes on page 78 for further information.</p>
Gas Ref. Conditions	<p>Selection of the reference pressure and reference temperature for determination of the standard condition.</p> <p>Possible selection: 14.7 psi, 60°F / 14.7 psi, 70°F / 1.013 bar, 0°C / 1.013 bar, 20°C</p>
Water/Steam Type	<p>Selection of the medium type in the operating mode 'Steam/Water Mass'.</p> <ul style="list-style-type: none"> • Saturated Steam: Saturated steam. • Overheated Steam: Overheated steam. • Hot Water: Hot water. <p>See Operating modes on page 78 and Energy measurement for steam / hot water in accordance with IAPWS-IF97 on page 83 for additional information.</p>
Density Selection	<p>Selection of the steam density source in operating mode 'Steam/Water Mass'.</p> <ul style="list-style-type: none"> • Ext. Density: Remote density transmitter at HART or analog input. • Calc. From P&T: Calculation of the density for saturated steam and overheated steam using a remote pressure transmitter and the integrated temperature sensor. • Calc. From T: Calculation of the density for saturated steam using the integrated temperature sensor. • Calc. From P: Calculation of the density from the pressure only
Energy calc. method	<p>Selection of the type of energy calculation in the operating mode Steam/Water Energy.</p> <ul style="list-style-type: none"> • Gross energy: The amount of energy that flows through the device is recorded. Any energy re-flow in form of condensate is not considered. • Net energy: The amount of energy that flows through the device is recorded. Any energy re-flow in form of condensate is deducted again from the amount of energy. <p>See Operating modes on page 78 and Energy measurement for steam / hot water in accordance with IAPWS-IF97 on page 83 for additional information.</p>

Menu / parameter	Description
Easy Setup	
Ref. Density	Setting of the standard density of the measuring medium.
Preset Density	Setting of the density (operating density) of the measuring medium as a constant.
Ref. Temperature	Setting of the reference temperature.
Preset Int.Temp	Setting of the measuring medium temperature as a constant. The value entered must correspond as closely as possible to the temperature of the measuring medium in the meter tube.
Preset Ext.Temp	Adjustment of the return flow temperature as constant for the calculation of net energy consumption.
Preset Pressure(abs)	Setting of the measuring medium pressure as a constant.
Preset Gas Content	Setting of the methane content as a constant.
Qvmax	Setting of the flow rate or energy quantity at which the current output is to output 20 mA (100 %).
QnMax	The value entered must be at least 15 % of $Q_{\dots\max\text{DN}}$.
QmMax	
QpowerMax	
Damping Qv	Setting of the damping (the value relates to 1 T [Tau]).
Damping Qn	The value relates to a step change in the flow rate or energy quantity.
Damping Qvp	The value affects the instantaneous value in the process display and at the current output.
Damping Qnp	Default setting: 1 second
Damping Qm	
Damping Qpower	
Temp->I=0%	Setting of the temperature at which the current output is to output 20 mA or 4 mA. Only available if parameter 'Output Value' has been set to 'Temperature'.
Temp->I=100%	
Damping Temperature	Setting of the damping (the value relates to 1 T [Tau]). The value relates to a step change in the temperature. The value affects the instantaneous value in the process display and at the current output.
Iout at Alarm	Selection of status of the current output in error condition. The output 'min.' or 'max.' current is set in the subsequent menu.
Low Alarm Value	Sets the current for min. alarm.
High Alarm Value	Sets the current for max. alarm.
Auto Zero	Starts the automatic zero point balancing using  . Note Prior to starting the zero point adjustment, make sure that: <ul style="list-style-type: none"> • There is no flow through the sensor (close all valves, shut-off devices etc.) • The sensor must be filled completely with measuring medium for measurement. • The adjustment process takes approximately 45 seconds. • If automatic zero point balancing does not yield the desired results, see chapter Zero point balance under operating conditions on page 134.
Low Flow Cutoff	Sets the switching threshold for the low flow cut-off. The set value relates to the $Q_{\dots\max\text{DN}}$ value in the selected operating mode. If the flow rate is below the switching threshold, there is no flow measurement. The setting of 0 % deactivates the low flow cut-off.

... 10Operation

... Parameter descriptions

Menu: Device Info



Note

This menu is only used to display the device parameters. The parameters are displayed independently of the configured access level but cannot be changed.

Menu / parameter	Description
Device Info	
Sensor	Selection of submenu ' Sensor ' using  .
Transmitter	Selection of submenu ' Transmitter ' using  .

Device Info / Sensor	
Sensor Type	Displays the sensor type. <ul style="list-style-type: none"> Swirl: Swirl flowmeters FSS430, FSS450 Vortex: Vortex flowmeters FSV430, FSV450
Meter(V) Size, Meter(S) Size	Displays the sensor nominal diameter.
QvMaxDN	Display of the maximum configurable upper range value for the respective operating mode. For information purposes only; the value cannot be changed – it is calculated from $Q_{...MaxDN}$ for the respective medium and the set parameters such as density, pressure, or temperature.
QmMaxDN	
QnMaxDN	
QpowerMaxDN	
Sensor ID	Displays the ID number of the sensor.
SAP/ERP No.	Displays the order number of the sensor.
Sensor Run Hours	Displays the operating hours of the sensor.
Calibration	Selection of submenu ' Calibration ' using  .

Device Info / Sensor / Calibration	
Cal. Date	Date of sensor calibration.
Cal. Cert. No.	Identification (no.) of the relevant calibration certificate.
Cal. Location	Location of sensor calibration.

Device Info / Transmitter	
Transmitter Type	Displays the transmitter type.
Transmitter ID	Displays the transmitter ID number.
SAP/ERP No.	Displays the order number of the transmitter.
Transmitter Version	Selection of submenu ' Transmitter Version ' using  .
Transmitter Run Hours	Displays the operating hours of the transmitter.
Calibration	Selection of submenu ' Calibration ' using  .
Manufacturer	Name of manufacturer.
Street	Address of manufacturer (street).
City	Address of manufacturer (city).
Phone	Telephone number of manufacturer.

Menu / parameter	Description
Device Info / Transmitter / Transmitter Version	
Transmitter FW Ver.	Displays the transmitter software version.
Transmitter HW Ver.	Displays the transmitter hardware version.
Frontend FW Version	Displays the sensor software version.
Frontend HW Version	Displays the sensor hardware version.
Bootloader Version	Displays the boot loader version.

Note



The firmware version specified on the name plate is a combination of the transmitter software version and the sensor software version.

Menu / parameter	Description
Device Info / Transmitter / Calibration	
Cal. Date	Date of transmitter calibration.
Cal. Cert. No.	Identification (no.) of the relevant calibration certificate.
Cal. Location	Location of transmitter calibration.

... 10Operation

... Parameter descriptions

Menu: Device Setup

Menu / parameter	Description
Device Setup	
Access Control	Selection of submenu 'Access Control' using  .
Sensor	Selection of submenu 'Sensor' using  .
Transmitter	Selection of submenu 'Transmitter' using  .
Plant/Customized	Selection of submenu 'Plant/Customized' using  .

Device Setup / Access Control



Standard Password	Entry / change of the password for the 'Standard' access level.
Read Only Switch	Display of switch position of the write protection switch (hardware write protection). See Operating modes on page 78 or Operating modes on page 78.

Device Setup / Sensor

QvMaxDN	Display of the maximum configurable upper range value for the respective operating mode. For information purposes only;
QmMaxDN	the value cannot be changed – it is calculated from $Q_{\dots\text{Max}}\text{DN}$ for the respective medium and the set parameters such as
QnMaxDN	density, pressure, or temperature.
QpowerMaxDN	
Qvmax	Setting of the flow rate or energy quantity at which the current output is to output 20 mA (100 %).
QvpMax	The value entered must be at least 15 % of $Q_{\dots\text{max}}\text{DN}$.
QmMax	
QnMax	
QnpMax	
QpowerMax	
Sensor Location Tag	Enter the TAG number of the flowmeter sensor (shown in the upper left of the process display). Alphanumeric, maximum 20 characters.
Sensor TAG	Enter the TAG number for the measuring sensor. Alphanumeric, maximum 20 characters.

Device Setup / Transmitter

Units	Selection of submenu '„Units“' using  .
Damping Qv	Setting of the damping (the value relates to 1 T [Tau]).
Damping Qm	The value relates to a step change in the flow rate, energy quantity, or temperature.
Damping Qn	The value affects the instantaneous value in the process display and at the current output.
Damping Qpower	Default setting: 1 second
Damping Temperature	
Low Flow Cutoff	Sets the switching threshold for the low flow cut-off. The set value relates to the $Q_{\dots\text{max}}\text{DN}$ value in the selected operating mode. If the flow rate is below the switching threshold, there is no flow measurement. The setting of 0 % deactivates the low flow cut-off.

Menu / parameter	Description
Device Setup / Transmitter / Units	
Unit Qv	Selection of unit for volume flow. m ³ /s, m ³ /min, m ³ /h, m ³ /d, ft ³ /s, ft ³ /min, ft ³ /h, ft ³ /d, l/s, l/min, l/h, l/d, USgal/s, USgal/min, USgal/h, USgal/d, impgal/s, impgal/min, impgal/h, impgal/d, bbl/s, bbl/min, bbl/h, bbl/d, Mft ³ /s, M ft ³ /min, M ft ³ /h, M ft ³ /day, MM ft ³ /s, MM ft ³ /min, MM ft ³ /h, MM ft ³ /day Factory setting: l/min
Unit Qm	Selection of unit for mass flow. g/s, g/min, g/h, kg/s, kg/min, kg/h, kg/d, t/s, t/min, t/h, t/d, lb/s, lb/min, lb/h, lb/d, US t/s, US t/min, US t/h, US t/d
Unit Qn	Selection of unit for the standard volume flow. m ³ /s, m ³ /min, m ³ /h, m ³ /d, ft ³ /s, ft ³ /min, ft ³ /h, ft ³ /d, kft ³ /s, kft ³ /min, kft ³ /h, kft ³ /d, l/s, l/min, l/h, l/d, Mft ³ /s, M ft ³ /min, M ft ³ /h, M ft ³ /day, MM ft ³ /s, MM ft ³ /min, MM ft ³ /h, MM ft ³ /day Factory setting: l/min
Unit Qpower	Selection of unit for energy measurement. W, MW, kW, kJ/s, kJ/min, kJ/h, kJ/d, MJ/h, BTU/s, BTU/min, BTU/h, BTU/d, MBTU/min, MBTU/h, MBTU/d, MMBTU/h, MMBTU/d, MJ/s, MJ/min, MJ/d, MBTU/s, MMBTU/s, MMBTU/min
Unit Density	Selection of unit for density. kg/m ³ , g/cm ³ , kg/l, g/ml, g/l, lb/in, lb/ft ³
Unit Temperature	Selection of unit for temperature. kelvin, celsius, fahrenheit
Unit Pressure	Selection of unit for pressure measurement. Pa, MPa, KPa, HPa, bar, mbar, psi, kg/cm ³
Unit Volume	Selection of unit for the volume totalizer. m ³ , ft ³ , l, imp gal, US gal, bbl, Mft ³ , MMft ³
Unit Mass	Selection of unit for the mass counter. g, kg, t, lb, US t
Unit Std/Norm Vol.	Selection of unit for the standard volume totalizer. m ³ , ft ³ , l, imp gal, US gal, bbl, Mft, MMft
Unit Energy	Selection of unit for the energy counter. J, kJ, MJ, BTU, MMBTU, Wh, MWh, kWh, MBTU
Device Setup / Plant/Customized	
Active Mode	Selection of operating mode (only for devices with HART® or Modbus® communication). See Operating modes on page 78 for further information.
Medium Type	Selection of the measuring medium (only for devices with PROFIBUS® or FOUNDATION Fieldbus® communication). <ul style="list-style-type: none"> • Liquid: Liquid measuring media • Gas: Gaseous measuring media • Steam: Steam as a measuring medium
Compensation Setting	Selection of submenu '„Compensation Setting“' using  .
Field optimization	Selection of submenu '„Field optimization' using  .

... 10Operation

... Parameter descriptions



Menu / parameter	Description
Device Setup / Plant/Customized / Compensation Setting	
Gas Density Selec.	<p>Selection of the density source for gas mass measurement in operating mode 'Gas Mass'.</p> <ul style="list-style-type: none"> • Ref. Density: Gas mass flow, calculated using pressure, temperature, and density under reference conditions. • Act. Density: Gas mass flow, calculated using the current density in the operating condition. <p>See Energy measurement for steam / hot water in accordance with IAPWS-IF97 on page 83 for further information.</p>
Gas Ref. Conditions	<p>Selection of the reference pressure and reference temperature for determination of the standard condition.</p> <p>Possible selection: 14.7 psi, 60°F / 14.7 psi, 70°F / 1.013 bar, 0°C / 1.013 bar, 20°C</p>
Water/Steam Type	<p>Selection of the medium type in the operating mode 'Steam/Water Mass'.</p> <ul style="list-style-type: none"> • Saturated Steam: Saturated steam. • Overheated Steam: Overheated steam. • Hot Water: Hot water. <p>See Operating modes on page 78 and Energy measurement for steam / hot water in accordance with IAPWS-IF97 on page 83 for additional information.</p>
Density Selection	<p>Selection of the steam density source in operating mode 'Steam/Water Mass'.</p> <ul style="list-style-type: none"> • Ext. Density: Remote density transmitter at HART or analog input. • Calc. From P&T: Calculation of the density for saturated steam and overheated steam using a remote pressure transmitter and the integrated temperature sensor. • Calc. From T: Calculation of the density for saturated steam using the integrated temperature sensor. • Calc. From P: Calculation of the density from the pressure only
Energy calc. method	<p>Selection of the type of energy calculation in the operating mode Steam/Water Energy.</p> <ul style="list-style-type: none"> • Gross energy: The amount of energy that flows through the device is recorded. Any energy re-flow in form of condensate is not considered. • Net energy: The amount of energy that flows through the device is recorded. Any energy re-flow in form of condensate is deducted again from the amount of energy. <p>See Operating modes on page 78 and Energy measurement for steam / hot water in accordance with IAPWS-IF97 on page 83 for additional information.</p>

Menu / parameter	Description
Device Setup / Plant/Customized / Field optimization	
Ref. Density	Setting of the standard density of the measuring medium.
Preset Density	Setting of the density (operating density) of the measuring medium as a constant.
Ref. Temperature	Setting of the reference temperature.
Preset Int.Temp	Setting of the measuring medium temperature as a constant. The value entered must correspond as closely as possible to the temperature of the measuring medium in the meter tube.
Preset Ext.Temp	Adjustment of the return flow temperature as constant for the calculation of net energy consumption.
Preset Pressure(abs)	Setting of the measuring medium pressure as a constant.
Preset Gas Content	Setting of the methane content as a constant.
Dynamic Viscosity	Setting of the dynamic viscosity of the measuring medium.
Temperature Offset	<p>Setting of the offset correction for the internal temperature measurement.</p> <p>Any deviation between the internal temperature measurement and an external temperature measurement can be corrected here. When doing this, the correction value must be offset against the existing balancing value.</p> <p>The correction can significantly improve accuracy; e.g. for a saturated steam measurement that does not take pressure into account.</p> <p>The temperature sensor is factory-calibrated at 22 to 28 °C. At operating temperatures significantly outside of this range, errors of up to ± 2 K can occur, which can be corrected under operating conditions.</p>
Auto Zero	<p>Starts the automatic zero point balancing using .</p> <p>NOTICE</p> <p>Prior to starting the zero point adjustment, make sure that:</p> <ul style="list-style-type: none"> • There is no flow through the sensor (close all valves, shut-off devices etc.) • The sensor must be filled completely with measuring medium for measurement. • The adjustment process takes approximately 45 seconds. • If automatic zero point balancing does not yield the desired results, see chapter Zero point balance under operating conditions on page 134.
Auto Zero status	<p>Display of whether automatic zero point balancing has been performed.</p> <p>If the zero point is not stable (flow indicator for zero flow), automatic balancing must be performed.</p>
Low Flow Thld.	<p>Setting of manual zero point balancing. The higher the value entered, the lower the sensitivity of the sensor.</p> <p>Setting range: 7 to 2000.</p> <p>See Zero point balance under operating conditions on page 134.</p>
Advanced filters	<p>3 selections possible:</p> <ol style="list-style-type: none"> 1. Off 2. Stalling filter to eliminate drop-offs in the lower range 3. Noise filter to eliminate noise effects on the output.

... 10Operation

... Parameter descriptions

Menu: Display

Menu / parameter	Description
Display	
Language	Selection of menu language.
Contrast	Contrast setting for the LCD display.
Operator Pages	Selection of submenu 'Operator Pages' using  . Up to four user-specific operator pages (layouts) can be configured for the process display. If multiple operator pages have been configured, these can be scrolled through manually on the information level. In the factory setting only Operator Page 1 is enabled.
Autoscroll	If Multiplex operation is enabled, you can also activate the 'Autoscroll' function on the information level of the operator menu. In this function, operator pages are automatically displayed in succession on the process screen, changing every 10 seconds. Manual scrolling through pre-configured operator pages as described above is no longer necessary. When Auto scroll mode is enabled, the icon  is displayed in the lower left corner of the screen.
Flowrate Format	Selection of number of decimal places (maximum 12) used to display the corresponding process variables.
Totalizer Format	
Date/Time Format	Set the display format for the date and time.
Display Test	Start the test of the LCD display with  .



Display / Operator Pages

Operator Page 1	Selection of submenu 'Operator Page 1' using  .
Operator Page 2	Selection of submenu 'Operator Page 2' using  .
Operator Page 3	Selection of submenu 'Operator Page 3' using  .
Operator Page 4	Selection of submenu 'Operator Page 4' using  .

Display / Operator Pages / Operator Page 1 ... n

Display Mode	Configure each operator page. The following versions can be selected: Off, Graph Format, 1x4, 1x6, 1x6 bar, 1x6, 1x6 bar, 1x9, 1x9 bar, 2x9, 2x9 bar, 3x9, 4x9. Selecting 'Off' deactivates the corresponding operator page.
1st Line	Selection of process variable displayed in the respective row.
2nd Line	
3rd Line	
Bargraph	Selection of process variable displayed as a bar graph.

Menu: Input/Output



Menu / parameter	Description
Input/Output	
Current Out	Selection of submenu 'Current Out' using  .
DO Function	Selection of submenu 'DO Function' using  .
Field Input	Selection of submenu 'Field Input' using  .

Input/Output / Current Out

Output Value	Selection of the process variable issued at the current output. <ul style="list-style-type: none"> • Q: Flow • T: Temperature
Qv->I=100%	Setting of the flow rate at which the current output is to output 20 mA (100 %).
Qn->I=100%	The value range depends on the nominal diameter of the sensor and the operating mode selected.
Qm->I=100%	Parameters will be displayed only if 'Q: Flow' has been selected for parameter 'Output Value'.
Qpower->I=100%	
Temp->I=100%	Setting of the temperature limits at which the current output is to output 4 mA or 20 mA.
Temp->I=0%	Parameters will be displayed only if 'T: Temperature' has been selected for parameter 'Output Value'.
Out at Alarm	Selection of status of the current output in error condition. The output 'high' or 'low' current is set in the subsequent menu.
Low Alarm Value	Sets the current for Low Alarm.
High Alarm Value	Sets the current for High Alarm.
Out at Flow>103%	Select the status of the current output when the upper range value is up-scaled. <ul style="list-style-type: none"> • Off: Error is not output through the current output. • High Alarm: The current output assumes the value for 'High Alarm'. The current output is 'frozen' at 20.5 mA and returns to the regular range once it falls below the upper range value. • Low Alarm: The current output assumes the value for 'Low Alarm'.

Input/Output / DO Function

Not for devices with FOUNDATION Fieldbus® communication!

Function	Selection of the function for the digital output. <ul style="list-style-type: none"> • None: Digital output deactivated. • Logic on DO: Digital output as a binary output (e.g. as an alarm output). • Pulse on DO: Digital output DO1 as a pulse output. In pulse mode, pulses are output per unit (e.g. 1 pulse per m3) • Freq on DO: Digital output DO1 as a frequency output. In frequency mode, a frequency is issued that is proportional to the flow rate. The maximum frequency can be configured in accordance with the upper range value.
Setup Pulse Out	Selection of submenu 'Setup Pulse Out' using  .
Setup Freq Out	Selection of submenu 'Setup Freq Out' using  .
Alarm Config	Selection of submenu 'Alarm Config' using  .
Logic on DO	Select switching properties for the binary output. <ul style="list-style-type: none"> • Normally Closed: Binary output to open a normally closed contact. • Normally Open: Binary output to close a normally open contact.

... 10Operation

... Parameter descriptions



Menu / parameter	Description
Input/Output / DO Function / Setup Pulse Out	
Pulses Per Unit	Setting of the pulses per unit of the selected operating mode and pulse width for the 'Pulse on DO' function of the digital output.
Pulse Width	<p>The pulse value relates to the set flow unit, not the totalizer unit.</p> <p>For the kW energy unit (1 kW = 1 kJ/s), the pulse output automatically refers to kJ, meaning that a pulse value of 1 would lead to 1 pulse per second at an energy flow of 1 kW. The maximum frequency of the pulse output is 10 kHz. The device automatically calculates the max. pulse width using Q_{max} and the pulse value. The pulse length and pulse pause are considered to be equal, with a safety factor of 1.1.</p> <p>Available only if the digital output has been configured as a pulse output.</p>
Input/Output / DO Function / Setup Freq Out	
Lower Frequency	Setting of the frequency range for the 'Freq on DO' function of the digital output Available only if the digital output has been configured as a frequency output.
Upper Frequency	
Input/Output / DO Function / Alarm Config	
General Alarm	Each alarm can be activated separately. This allows for individual configuration when the digital output signals an alarm.
Min Flowrate Alarm	
Max Flowrate Alarm	
Min Sensor T Alarm	
Max Sensor T Alarm	
Flow Cutoff Alarm	
Input/Output / Field Input	
Analog In Value	<p>Selection of the process variable measured via the analog input.</p> <ul style="list-style-type: none"> • None: No remote transmitter at the input. • Temperature: Remote temperature transmitter at the input (transmitter in the reverse flow of a heating or cooling cycle for net energy calculation or transmitter in the device outlet (see Installation for external pressure and temperature measurement on page 37) for temperature compensation, if no internal temperature measurement is possible / desired). • Pressure: Remote pressure transmitter at the input. • Pressure(abs): Remote absolute pressure transmitter at the input. • Density: Remote transmitter at the input. • Int.T: External temperature transmitter, e.g. for using a remote temperature transmitter instead of the internal temperature sensor to increase the accuracy or reduce the response time. <p>Refer to Analog input 4 to 20 mA on page 51.</p>

Menu / parameter	Description
Input/Output / Field Input (continued)	
T Ext. Upper Range	Setting of the measuring range limits for the external transmitter at the analog input.
T Ext. Lower Range	The upper value applies for a current of 20 mA at the analog input, the lower value for a current of 4 mA.
T Int. Upper Range	The availability of this parameter depends on the process variable selected for the analog input.
T Int. Lower Range	
Pressure Upper Range	
Pressure Lower Range	
P(abs) Upper Range	
P(abs) Lower Range	
Density Upper Range	
Density Lower Range	
Ext.Cutoff Trigger	<p>Selection of the switching point for externally switching off the output via the analog input.</p> <p>If the switching point is exceeded, the flow measurement is set to zero.</p> <p>Possible switching points: > 4 mA, > 8 mA, > 12 mA</p>
HART In Value	<p>Selection of the process variable measured via the HART input.</p> <p>For description, see parameter 'Analog In Value'.</p> <p>Refer to HART® communication with remote transmitter on page 51.</p>

... 10Operation

... Parameter descriptions

Menu: Process Alarm

Menu / parameter	Description
Process Alarm	
Diagnostic History	Display of the alarm history.
Clear History	Reset of the alarm history.
Group Masking	Selection of submenu ' Group Masking ' using  .
Individual Masking	Selection of submenu ' Individual Masking ' using  .
Alarm Limits	Selection of submenu ' Alarm Limits ' using  .

Process Alarm / Group Masking

Maintenance Required	Alarm messages are divided into groups.
Function Check	If masking is activated for a group (On), no alarm is issued.
Out Of Specification	For more detailed information, see Diagnosis / error messages on page 136.

Process Alarm / Individual Masking

Min Flowrate Alarm	Individual alarm messages can also be masked. These are not included in the masking for the group. If masking is activated
Max Flowrate Alarm	for an alarm (On), no alarm occurs.
Flow > 103%	For more detailed information, see Diagnosis / error messages on page 136.
Flow Cutoff Alarm	There are no alarms masked by default.
Int. T Sensor Fault	
Medium Temp OffSpec.	
Housing Temp OffSpec.	

Process Alarm / Alarm Limits

Min Qv Alarm	Sets the minimum / maximum limit value for volume measurement. If the volume flow exceeds or falls below the limit values, an alarm is triggered.
Max Qv Alarm	
Min Qm Alarm	Sets the minimum / maximum limit value for mass measurement. If the mass flow up-scales or down-scales the limit values, an alarm is triggered.
Max Qm Alarm	
Min Temp.Alarm	Sets the minimum / maximum limit value for temperature measurement. If the measuring medium temperature exceeds or falls below the limit values, an alarm is triggered.
Max Temp.Alarm	
Min P(abs) Alarm	Sets the minimum / maximum limit value for pressure measurement. If the pressure exceeds or falls below the limit values, an alarm is triggered.
Max P(abs) Alarm	
Min Re Alarm	Setting of the minimum / maximum limit values for the Reynolds number (Re). If the Reynolds number (Re) exceeds or falls below the limit values, an alarm is triggered.
No HART Input Alarm	Setting of the delay time in seconds for error message 'No HART Burst In' if the external HART input has been activated. Value range: 5 to 10800 seconds (3 hours)

Menu: Communication for devices with HART® communication

Menu / parameter	Description
Communication	
HART	Selection of submenu 'HART' using  .
Communication / HART	
Device Address	Selection of HART device address. Note The HART protocol has provisions for creating a bus with up to 15 devices (1 to 15). If an address greater than 0 is set, the device operates in multidrop mode. The current output is then fixed at 4 mA. Apart from that, the current output is only used for HART communication.
Tag	Entry of a HART TAG number as unique identifier for the device. Alphanumeric, a maximum of 8 characters, upper case only, no special characters.
Descriptor	Entry of a HART descriptor. Alphanumeric, a maximum of 16 characters, upper case only, no special characters.
Message	Display of the alphanumeric TAG number.
Manuf. ID	Display of the HART manufacturer ID. ABB = 26
Device ID	Display of the HART device ID.
Last Command	Display of the most recently sent HART command.

... 10Operation

... Parameter descriptions

Menu: Communication for devices with Ethernet-APL communication

Menu / parameter	Description
Communication	
Ethernet	Selection of submenu ' Ethernet ' using  .
Communication / ...Ethernet / ...Service Port	
Baud Rate	Selection of the transmission speed (baud rate) for the service port. Factory setting: 9600 bd.
Communication / ...Ethernet / ...General	
Protocol Stack	Set the communications protocol stack. <ul style="list-style-type: none"> • PROFINET IO
Communication / ...Ethernet / ...Internet Layer	
DHCP Client	Factory setting: Disable. If 'Disable' has been selected, the host IP address is 192.168.001.122 by default. <ul style="list-style-type: none"> • Enable • Disable For PROFINET communication, the DHCP function (Dynamic Host Configuration Protocol) is not supported, the PROFINET DCP (Discovery and Configuration Protocol) is used instead.
Host IP Address	Allows the IP address to be set. 192.168.001.122 is the factory setting, if the DHCP client is set to fixed IP.
Subnet Mask	Factory setting: 255,255,255,000
Gateway IP Address	Factory setting = 000.000.000.000 If you are dealing with a part of a subnet, the first block of numbers should be identical with the HOST IP - for example, 192.168.001.xxx.
Host name	Factory setting: ABB-FSX4x0
Domain name	Factory setting: my-domain
MAC Address	Display of the device's MAC address
NTP Srv. Address 1	Factory setting: 000.000.000.000
NTP Srv. Address 2	Factory setting: 000.000.000.000
DNS IP Address 1	automatically set at DHCP = ON: 000.000.000.000
DNS IP Address 2	

Menu / parameter	Description
Communication / ...Ethernet / PROFINET	
Access	Factory setting: Full. Set to 'Full' or 'Read only' for Omron or Rockwell PLC. <ul style="list-style-type: none"> • Disable • Read only • Full
Vendor ID	Display of the device manufacturer ID. 0xF100
Device Name	PROFINET station name (can only be written via PROFINET) 40 x ASCII characters Factoring setting value is according to meter code.
Device ID	Display of the device ID. 0xB330
Select Device Profile	Selection of device profile <ul style="list-style-type: none"> • PA Profiles 0xB330: PNO Profile GSD(factory setting) • ABB 0x3439: Manufacturer-specific GSD
Device Tag	Can only be written via PROFINET (e.g. I&M1) 32 x ASCII characters
SNMP Access	Activate / deactivate SNMP access. <ul style="list-style-type: none"> • Disable • Read only • Full (Recommended for PROFINET)

Menu / parameter	Description
Communication / ...Ethernet / ...ModBus TCP	
Access	Factory setting: Full. <ul style="list-style-type: none"> • Disable • Read only • Full
IEEE Format	Factory setting: Enable. <ul style="list-style-type: none"> • Enable • Disable

Communication / ...Ethernet / ...WebServer	
Access	Factory setting: Full. <ul style="list-style-type: none"> • Disable • Read only • Full
Reset Credentials	Allows the reset of the web server password.
Session Timeout	Time out period to close the web server session. Standard value: 5 minutes. Possible settings: Min.: 1 minute, Max. 99999 minutes.



Communication / ...Ethernet / ...Diagnostics	
TCP Connections	Active TCP connections.
Data Received	No. of bytes received from client.
Data Transmitted	No. of Bytes send to client.
Receive Errors	No. of error frames received.
Transmit Collisions	No. of transmission collisions.

* If base PROFINET protocol selected.

... 10Operation

... Parameter descriptions





Menu: Communication for devices with Modbus® communication

Menu / parameter	Description
Communication	
Service Port	Selection of submenu 'Service Port' using  .
MODBUS	Selection of submenu 'MODBUS' using  .
Communication / Service Port	
Baud Rate	Selection of the transmission speed (baud rate) for the service port. Factory setting: 9600 bd.
Communication / MODBUS	
Address	Setting of the Modbus device address. Setting range: 1 to 247. Factory setting: 247
Baud Rate	Selection of the transmission speed (bit rate) for the Modbus communication. <ul style="list-style-type: none"> • 1200 bps • 2400 bps • 4800 bps • 9600 bps Factory setting: 9600 bps
Parity	Selection of the parity for the Modbus communication. <ul style="list-style-type: none"> • NULL • Even • Odd Factory setting: NULL
RespDelayTime	Setting of the pause time in milliseconds after receiving a Modbus command. The device sends a response no earlier than expiration of the set pause time. Setting range: 0 to 200 ms Factory setting: 50 ms
Address Offset	Selection of the address offset for the Modbus address (PLC Base 0 or PLC Base 1). In the Modbus protocol, there are two options for register addressing. Depending on the manufacturer, the start address of the register is defined as '0' (e.g. 40000) or '1' (e.g. 40001). <ul style="list-style-type: none"> • Zero Base: Modbus addresses PLC Base 0 • One Base: Modbus addresses PLC Base 1 Factory setting: One Base

Menu: Communication for devices with PROFIBUS PA® communication

Menu / parameter	Description
Communication	
...PROFIBUS	Selection of submenu ' PROFIBUS ' using  .

Communication / PROFIBUS

Tag	Entry of a unique PROFIBUS TAG number as an identifier for the device. Alphanumeric, a maximum of 8 characters, upper case only, no special characters.
Device Adresse	Setting the PROFIBUS PA device address (1 to 126).
IdentNr Selector	Selecting the PROFIBUS PA identification number
AI1 Block	Selection of submenu ' AI1 Block, AI2 Block, AI3 Block ' using  .
AI2 Block	
AI3 Block	
TOT1 Block	Selection of submenu ' TOT1 Block, TOT2 Block, TOT3 Block ' using  .
TOT2 Block	
TOT3 Block	
DI Block	Selection of submenu ' DI Block ' using  .
AO1 Block	Selection of submenu ' AO1 Block, AO2 Block, AO3 Block ' using  .
AO2 Block	
AO3 Block	
Service Port Config	Selection of the transmission speed (baud rate) for the service port. Factory setting: 9600 bd.

Communication / PROFIBUS / AI1 Block**Communication / PROFIBUS / AI2 Block****Communication / PROFIBUS / AI3 Block**

Tag	Entry of a name for the respective AI input block. Alphanumeric, a maximum of 8 characters, upper case only, no special characters.
Channel	Display of the process variables assigned to the respective AI input blocks.*
PV Time	Damping of the output signal

Communication / PROFIBUS / TOT1 Block**Communication / PROFIBUS / TOT2 Block****Communication / PROFIBUS / TOT3 Block**

Tag	Entry of a name for the respective TOT output block. Alphanumeric, a maximum of 8 characters, upper case only, no special characters.
Channel	Display of the process variables assigned to the respective TOT output blocks.*

* The process variables are assigned to the blocks via the control system during commissioning.

... 10Operation

... Parameter descriptions



Menu / parameter	Description
Communication / PROFIBUS / DI Block	
Tag	Entry of a name for the respective DI input block. Alphanumeric, a maximum of 8 characters, upper case only, no special characters.
Channel	Display of the DI input block function.* <ul style="list-style-type: none"> • Output deactivation: remote output deactivation through the DI input block, sets the flow measurement to 0. • Low flow: Remote low flow volume deactivation through the DI input block
Communication / PROFIBUS / AO1 Block	
Communication / PROFIBUS / AO2 Block	
Communication / PROFIBUS / AO3 Block	
Tag	Entry of a name for the respective AO output block. Alphanumeric, a maximum of 8 characters, upper case only, no special characters.
Channel	Display of the process variables assigned to the respective AO output blocks.* <ul style="list-style-type: none"> • Temperature: Output of the temperature of the internal temperature sensor. • Temperature 2: Output of the temperature of the remote temperature sensor. • Pressure: Output of the measured value of the remote pressure transmitter • Pressure(abs): Output of the measured value of the remote pressure transmitter (absolute pressure) • Density: Output of the density. • Gas Content: Output of the gas proportion

* The process variables and functions are assigned to the blocks via the control system during commissioning.

Menu: Communication for devices with FOUNDATION Fieldbus® communication

Menu / parameter	Description
Communication	
Fieldbus FF	Selection of the 'Fieldbus FF' submenu using  .

Communication / Fieldbus FF

Tag	Entry of a unique FOUNDATION Fieldbus TAG number as an identifier for the device. Alphanumeric, a maximum of 8 characters, upper case only, no special characters.
Device Adresse	Setting the FOUNDATION Fieldbus device address (1 to 126).
Device Boot Type	Selection of the FOUNDATION Fieldbus operating mode. <ul style="list-style-type: none"> • Basic: Operation of the device as a 'basic device'. • Link Master: Operation of the device as a 'Link Master'.
DD Revision	Selection of the FOUNDATION Fieldbus DD Revision.
A11 Block	Selection of submenu ' A11 Block, A12 Block, A13 Block ' using  .
A12 Block	
A13 Block	
DI Block	Selection of submenu ' DI Block ' using  .
AO1 Block	Selection of submenu ' AO1 Block, AO2 Block, AO3 Block ' using  .
AO2 Block	
AO3 Block	
Service Port Config	Selection of the transmission speed (baud rate) for the service port. Factory setting: 9600 bd.

Communication / Fieldbus FF / A11 Block**Communication / Fieldbus FF / A12 Block****Communication / Fieldbus FF / A13 Block**

Tag	Entry of a name for the respective AI input block. Alphanumeric, a maximum of 8 characters, upper case only, no special characters.
Channel	Display of the process variables assigned to the respective AI input blocks.*
PV Time	Damping of the output signal

* The process variables are assigned to the blocks via the control system during commissioning.





... 10Operation

... Parameter descriptions

Menu / parameter	Description
Communication / Fieldbus FF / DI Block	
Tag	Entry of a name for the respective DI input block. Alphanumeric, a maximum of 8 characters, upper case only, no special characters.
Channel	Display of the DI input block function.* <ul style="list-style-type: none"> • Output deactivation: remote output deactivation through the DI input block, sets the flow measurement to 0. • Low flow: Remote low flow volume deactivation through the DI input block
Communication / Fieldbus FF / AO1 Block	
Communication / Fieldbus FF / AO2 Block	
Communication / Fieldbus FF / AO3 Block	
Tag	Entry of a name for the respective AO output block. Alphanumeric, a maximum of 8 characters, upper case only, no special characters.
Channel	Display of the process variables assigned to the respective AO output blocks.* <ul style="list-style-type: none"> • Temperature: Output of the temperature of the internal temperature sensor. • Temperature 2: Output of the temperature of the remote temperature sensor. • Pressure: Output of the measured value of the remote pressure transmitter • Pressure(abs): Output of the measured value of the remote pressure transmitter (absolute pressure) • Density: Output of the density. • Gas Content: Output of the gas proportion

* The process variables and functions are assigned to the blocks via the control system during commissioning.

Menu: Diagnostics

Menu / parameter	Description
Diagnostics	
Diagnosis Control	Selection of submenu ' Diagnosis Control ' using  .
Diagnosis Values	Selection of submenu ' Diagnosis Values ' using  .
Simulation Mode	Selection of submenu ' Simulation Mode ' using  .
Output Readings	Selection of submenu ' Output Readings ' using  .
Alarm Simulation	Selection of submenu ' Alarm Simulation ' using  .

Diagnostics / Diagnosis Control

Sensor Self Check	Start of sensor self-test using  . The device runs a self-test of the Piezo sensor and PT100 temperature sensor for wire breaks or short-circuits. Any errors detected will immediately trigger a corresponding error message. Refer to Possible error messages on page 138.
Maintenance Cycle	Sets the service interval. After the maintenance interval has expired, the corresponding error message 'Maintenance Warning' is set. A new interval can be started by entering a new value to reset the maintenance alarm.

Diagnostics / Diagnosis Values

Reynolds Number	Display of the current Reynolds number (Re).
Ext. Temperature	Display of the current measuring medium temperature.
Housing Temperature	Display of the current housing temperature in °C.
AI Value	Display of the current measured value at the analog input.

Diagnostics / Simulation Mode

Off	Manual simulation of measured values. After selecting the value to be simulated, a corresponding parameter is displayed in
Volume Flow Unit	the menu 'Diagnostics / Simulation Mode'. The simulation value can be set here.
Volume Flow	The output values correspond to the simulated flowrate entered.
Volume Flow[%]	Information 'Configuration' appears in the lower line of the display.
Mass Flow Unit	Only one measured value / output can be selected for simulation.
Mass Flow	After power-up / restart of the device, the simulation is switched off.
Mass Flow[%]	
Temperature Unit	
Medium Temperature	
Housing Temperature	
Current Out	
Freq on DO	
Logic on DO	
Pulse on DO	
AI Value	
Sensor Freq	

... 10Operation

... Parameter descriptions

Menu / parameter	Description
Diagnostics / Output Readings	
Current Out	Display the current values and statuses of the listed inputs and outputs.
DO Pulse	
DO Frequency	
DO State	

Diagnostics / Alarm Simulation

Manual simulation of alarms / error messages.

The simulated alarm is selected by setting the parameter to the corresponding error.

Refer to **Diagnosis / error messages** on page 136.

The following error messages can be simulated:

Off, sim. current output, sim. switch output, Sig. Sensor Fault, Int. T Sensor Fault, Vbr.Sensor Fault, AI Out of Range, Max Flowrate Alarm, Max Int. Temp Alarm, AI Cut Off, Max Pressure Alarm, Min Flowrate Alarm, Min Int. Temp Alarm, Current Output Saturated, Min Pressure Alarm, Bad SNR , Sensor NV Error, Sensor Not Calibrated, Sync. Signal Error, Sensor Comm Error, Transmitter NV Error, AI Comm Error, Pulse Output Cutoff, Re. Out of Range, Wrong Steam Type, Maintenance Warning, Voltage Warning, Min Housing T Alarm, Flowrate Cutoff, Flowrate > 103%, Data Simulation, Alarm Simulation, Fixed Current Output, Current Output Fault , CO Readback High, CO Readback Low, NV Replace Warning, Sensor RAM Fault, Totalizer Stop, FE Electronic out of Limit, No HART Burst In.

Menu: Totalizer

Menu / parameter	Description
Totalizer	
Start	Selection of submenu ' Start ' using  .
Stop	Selection of submenu ' Stop ' using  .
Reset	Selection of submenu ' Reset ' using  .
Preset	Selection of submenu ' Preset ' using  .

Totalizer / Start

All Totalizers	Starts all counters.
Act.Volume Totalizer	Starts the selected counters.
Std.Volume Totalizer	
Mass Totalizer	
Energy Totalizer	



Totalizer / Stop

All Totalizers	Stops all counters.
Act.Volume Totalizer	Stops the selected counters.
Std.Volume Totalizer	
Mass Totalizer	
Energy Totalizer	

Totalizer / Reset

All Totalizers	Resets all counters.
Act.Volume Totalizer	Resets the selected counters.
Std.Volume Totalizer	
Mass Totalizer	
Energy Totalizer	

Totalizer / Preset

Enter Preset Value	Selection of submenu ' Enter Preset Value ' using  .
Set To Preset Value	Selection of submenu ' Set To Preset Value ' using  .

... 10Operation

... Parameter descriptions

Menu / parameter	Description
Totalizer / Preset / Enter Preset Value	
Act.Volume Totalizer	Input from meter readings (e.g. when replacing the transmitter).
Std.Volume Totalizer	
Mass Totalizer	
Energy Totalizer	

Totalizer / Preset / Set To Preset Value	
Act.Volume Totalizer	Sets the counters to the values entered under 'Totalizer / Preset / Enter Preset Value'.
Std.Volume Totalizer	
Mass Totalizer	
Energy Totalizer	

Counter overflow

All counters count up to 10 million (in the selected totalizer unit). After a value of 10 million is reached, the corresponding overflow counter is incremented by one and the totalizer value is reset to zero to continue counting the flow.

To indicate in the process display that an overflow has occurred, a corresponding warning is displayed on the LCD indicator.

Threshold for counter overflow = 10,000,000 Kg (m³ or KJ)

Counter reading = Current counter reading + (number of counter overflows × 10,000,000)

Software history

In accordance with NAMUR recommendation NE53, ABB offers a transparent and traceable software history.

Standard and HART® Version

Firmware version (name plate)	Transmitter firmware version	Sensor firmware version	Date	Type of change	Associated operating instruction
01.00.00	01.03.00	01.04.00	06.2014	New release	OI/FSS/FSV430/450 Rev. B
02.00.00	01.04.00	01.04.02	11.2015	Supplement to the hot water calculation, SIL introduction	OI/FSS/FSV430/450 Rev. D
02.00.01	01.04.00	01.04.03	03.2018	Improvement of signal stability	OI/FSS/FSV430/450 Rev. D
02.01.00	01.05.00	01.04.03	05.2018	Update of steam calculation	OI/FSS/FSV430/450 Rev. E
02.01.01	01.05.00	01.04.04	09.2018	Improvement of filter settings	OI/FFS/FSV430/450 Rev. E
02.02.00	02.00.00	01.04.04	11.2019	Improvement of the stability of the analog input	OI/FFS/FSV430/450 Rev. F
03.00.01	02.00.02	01.04.15	08.2021	New advanced filter	OI/FFS/FSV430/450 Rev. G
07.01.00	02.01.00	02.01.00	08.2024	New FE board generation	OI/FFS/FSV430/450 Rev. H
07.01.01	02.01.02	02.01.02	11.2024	Bug fixing	OI/FFS/FSV430/450 Rev. H
07.01.02	02.01.10	02.01.10	08.2025	SIL version for new FE board generation	OI/FFS/FSV430/450 Rev. I
07.01.03	02.01.11	02.01.10	08.2025	CB compatibility enhancement (Not for SIL)	OI/FFS/FSV430/450 Rev. I

Ethernet-APL™ Version

Firmware version (name plate)	Transmitter firmware version	Sensor firmware version	Date	Type of change	Associated operating instruction
01.00.00	01.00.11	02.01.00	08.2024	New release	OI/FSS/FSV430/450 Rev. H

Modbus RTU® Version

Firmware version (name plate)	Transmitter firmware version	Sensor firmware version	Date	Type of change	Associated operating instruction
01.00.00	01.00.00	01.04.00	10.2015	New release	OI/FSS/FSV430/450 Rev. C
01.00.01	01.00.00	01.04.03	03.2018	Improvement of signal stability	OI/FSS/FSV430/450 Rev. D
01.00.02	01.00.02	01.04.04	11.2019	Bug fixing, improvement of filter settings	OI/FFS/FSV430/450 Rev. F
02.00.00	02.00.xx	01.04.15	09.2021	FSx450 Modbus	OI/FFS/FSV430/450 Rev. G
02.01.00	02.01.00	01.04.15	04.2024	Bugfixing	OI/FFS/FSV430/450 Rev. H
02.02.00	02.02.04	02.01.10	08.2025	New FE board generation	OI/FFS/FSV430/450 Rev. I

PROFIBUS PA® Version

Firmware version (name plate)	Transmitter firmware version	Sensor firmware version	Date	Type of change	Associated operating instruction
01.00.06	01.00.06	01.04.03	07.2018	New release	OI/FSS/FSV430/450 Rev. E
01.00.08	01.00.08	01.04.04	04.2020	Bug fixing, improvement of filter settings	OI/FFS/FSV430/450 Rev.F
01.00.09	01.00.09	01.04.15	02.2022	Bug fixing	OI/FFS/FSV430/450 Rev. G
01.00.13	01.00.13	01.04.15	08.2025	Bug fixing	OI/FFS/FSV430/450 Rev. I

FOUNDATION Fieldbus® Version

Firmware version (name plate)	Transmitter firmware version	Sensor firmware version	Date	Type of change	Associated operating instruction
01.00.06	01.00.06	01.04.03	07.2018	New release	OI/FSS/FSV430/450 Rev. E
01.00.08	01.00.08	01.04.04	04.2020	Bug fixing, improvement of filter settings	OI/FFS/FSV430/450 Rev.F
01.00.10	01.00.10	01.04.15	01.2022	Bug fixing	OI/FFS/FSV430/450 Rev. G

... 10Operation

Zero point balance under operating conditions

Automatic zero point balancing

With automatic zero point balancing, the transmitter determines the noise threshold of the sensor signal automatically. As long as the sensor signal remains above the determined noise threshold, this is recognized as a valid flow signal.

Automatic zero point balancing should be rerun in the event of the following changes:

- Change in external installation conditions, such as more or fewer vibrations, pulsations, or electromagnetic field interspersions.
- Replacement of the communication board in the transmitter.
- Replacement of the sensor or sensor electronics.

For zero point balancing, the conditions in the meter tube have to correspond to the operating conditions for zero flow.

Automatic zero point balancing is started in the 'Device Setup / Plant/Customized / Field optimization / Auto Zero' menu.

Note

If the results of automatic zero point balancing are not acceptable, manual zero point balancing can be performed.

Manual zero point balancing

For manual zero point balancing, the noise threshold of the sensor signal must be determined manually. The same requirements apply for manual zero point balancing as for automatic zero point balancing.

1. Read out the signal amplitude of the source of interference in the 'Service / Sensor / Sig. Amplitude' menu. Note down the maximum value of the signal amplitude.
2. Multiply the calculated maximum value by a safety factor of between 1.2 and 2.0. Experience has shown that a value of 1.7 yields very good results.
3. Enter the calculated value in the 'Device Setup / Field optimization / Low Flow Thld.' menu.
4. Check the zero point setting in the process display / at the current output.
5. Check whether the lowest desired lower range value can be achieved with the new zero point setting.

Note

Zero point settings > 3000 (> 200 for previous HART FW revisions ≤ 03.00.01 or Modbus FW revision ≤ 02.01.00) indicate an elevated potential for interference (vibrations, pulsations or EMC interference).

The installation location and installation of the device should therefore be checked and appropriate measures taken, if necessary, to eliminate interference.

Advanced filter

In order to eliminate spikes on the output, caused by drop-offs or temporary loss of the signal, 2 optional advanced filters are available. Activating one of the advanced filters will have an impact on the device reaction time on real flow changes. The setting of the damping is no longer relevant for the meter response time. The default device set-up for the filters is 'off'.

Stalling filter

This filter is to eliminate drop-offs on the output signal caused by signal loss caused by temporarily poor flow pulses. As long as the quality of the picked-up pulses are sufficient to determine a flow frequency, the filter can help to stabilize the signal quality specifically at the low end. This filter only works in the lower 30 % range of Q_{maxDN} of the device. An additional measuring error is possible.

Noise filter

This filter is to minimize noise effects on the output in both directions, up and down. This filter works over the full meter range and help to eliminate noise effects caused by the application, e.g. pulses, cavitation, vibration or the environment, e.g. EMC impact. An additional measuring error is possible.

Noise suppression

50 or 60 Hz power-line interference will inevitably superimpose on the sensor signal. The calculation principle of swirl and vortex flowmeter is based on the calculation of a signal frequency. In the case of low flow and zero flow, 50 or 60 Hz power-line interference can be recognized by the flowmeter as a real flow signal and a wrong flow value will be obtained.

In case of power line interferences, a 50 or 60 Hz interference suppression can be applied:

1. Shut off the flow pipe, create zero flow conditions.
2. Execute Autozero as described above.
3. Select Menu 'Device Setup / ...Plant/Customized / Noise Suppression'
4. Select depending on the AC frequency of the field power supply 50 Hz or 60 Hz suppression mode.
5. Check the result in the LCD indicator.
6. In case the device still does not show zero flow, increase the noise upper limit manually by 10 % steps.

NOTICE

Impairment of the meter performance

Activating the noise compression can impact the meter performance at the lower flow range.

- After activating the suppression carefully check the measuring performance in the working range.

11 Diagnosis / error messages

General Notes

The following checks should be performed whenever a malfunction occurs. This will help to isolate and remedy the cause of the malfunction.

Sensor

Check the following:

- Has the device been installed in accordance with the installation conditions?
- Have the nominal diameter and measuring range been selected in accordance with the application?
- Does the flow direction correspond to the direction indicated on the device?
- Have the electrical connections been completed correctly?
- Run the device self-test in the 'Diagnostics / Diagnosis Control / Sensor Self Check' menu. Take note of any error messages.

Application conditions

Check the following:

- Do the density and viscosity of the measuring medium correspond to the requirements of the selected nominal diameter of the device?
- Is the measuring medium a multiphase medium?
- Gas inclusions in liquid measuring media and condensate in gaseous measuring media can cause significant measuring errors. Multiphase media should therefore be avoided.

Zero point balancing

Complete zero point balancing in accordance with **Zero point balance under operating conditions** on page 134.

Pipe vibrations

Please observe the following points:

- Take appropriate measures to dampen pipe vibrations at the sensor inlet and outlet.
- Take suitable measures to dampen vibrations in the kHz range, which are transferred by brackets, for example.

Transmitter

Check the following:

- Check the supply voltage at the transmitter terminals. Check the length of the power supply cable, see **Current output / HART output** on page 50.
- Make sure the transmitter unit is seated correctly. Check the transmitter plug connectors for damage.
- Check the following parameters in the order specified.
Sensor Type: Swirl or Vortex (in accordance with the name plate).
Meter(V) Size: Nominal diameter of the device (in accordance with the name plate).
Active Mode / Medium Type: Corresponds to the application.
- Make sure the electrical connections of the device are correct.
- The sensor, transmitter and power supply for the device should be connected to the same potential, if possible.
- The signal cable for the remote mount design must not be exposed to strong magnetic fields.

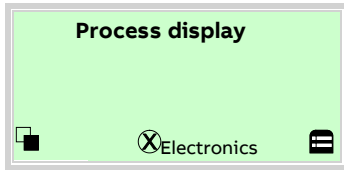

Calling up the error description

Additional details about the error that has occurred can be called up on the information level.

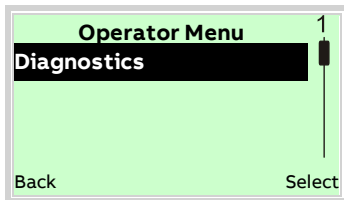

1. Use  to switch to the information level (Operator Menu).



2. Use  /  to select the submenu 'Diagnostics'.
3. Confirm the selection with .

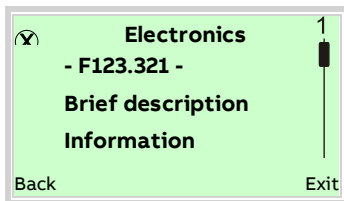

The error message is shown on the display according to priority.

The first line shows the area in which the error has occurred.

The second line shows the unique error number. It is made up of the priority (Fxxx) and the error position (.xxx)

The next lines show a brief description of the error and information on how to remedy it.

You absolutely need to scroll the display further to read the error message in more detail.

Note

For a detailed description of the error messages and information on troubleshooting, see the following pages.

... 11 Diagnosis / error messages

Possible error messages

The error messages are divided into four groups in accordance with the NAMUR classification scheme. Depending on the model variant, not all error messages are always available.

Errors

Error no. / Range		Text on the LCD display	Cause	Remedy
HART / Modbus	PA / FF			
F217.041 / Electronics*	—	CO Readback High	Incorrectly calibrated current output or faulty electronics.	Contact ABB Service.
F216.042 / Electronics*	—	CO Readback Low	Incorrectly calibrated current output or faulty electronics.	Contact ABB Service.
F215.020 / Electronics	F215.001 / Electronics	Sensor Comm Error	Communication errors between sensor and transmitter.	Check electrical connections between sensor and transmitter.
F214.019 / Electronics	F214.002 / Sensor	Sync. Signal Error	Error in SensorMemory.	Switch transmitter off and back on again. If the error remains, contact ABB Service.
F213.000 / Sensor	F213.003 / Sensor	Sig. Sensor Fault	Errors in sensor self-test. Signal errors from Piezo sensor.	Contact ABB Service.
F212.001 / Sensor*	F212.004 / Sensor	Int. T Sensor Fault	Errors in internal temperature sensor.	Contact ABB Service.
F211.002 / Sensor	F211.005 / Sensor	Vbr.Sensor Fault	Errors in sensor self-test. Signal errors from Piezo sensor.	Contact ABB Service.
F210.016 / Electronics	F210.006 / Electronics	Bad SNR	Signal-to-noise ratio for the sensor signal is outside of the set limit values.	Increase the flow rate. Check the setting in the 'Process Alarm / Alarm Limits' menu and adjust if necessary.
F209.017 / Electronics	F209.007 / Electronics	Sensor NV Error	Faulty transmitter electronics.	Replace transmitter electronics or contact ABB Service.
F208.044 / Electronics	F207.008 / Electronics	Sensor RAM Fault	Faulty transmitter electronics.	Replace transmitter electronics or contact ABB Service.
F207.023 / Electronics	—	Transmitter NV Error	Faulty communication board.	Replace the communication board or contact ABB Service.
F203.040 / Electronics*	—	Current Output Fault	Current output errors.	Contact ABB Service.

* Not for devices with Modbus communication

Function check

Error no. / Range		Text on the LCD display	Cause	Remedy
HART / Modbus	PA / FF			
C202.024 / Electronics*	—	AI Comm Error	Errors in signal at analog input.	Check the electrical connection at the analog input.
—	C160.000 / Operation**	Not Remove FF Check	One of the blocks is out of service.	Contact ABB Service.
C155.045 / Configuration	S155.023 / Operation**	Totalizer Stop	Counter stopped.	Start counter in menu 'Totalizer / Start'.
C154.039 / Configuration*	—	Fixed Current Output	The current output is simulated and is currently set to a specific value. The error message is displayed if the HART address is not 0 (HART multidrop mode, current output is set permanently to 4 mA).	In the 'Diagnostics / Simulation Mode' menu, deactivate simulation mode. Alternatively, set the HART address to 0 in the 'Communication' menu.
—	C153.009 / Operation	No AO Input	Error in AO block.	Check DCS signal.
C153.047 / Configuration*	—	No HART Burst In	Errors in signal at HART input.	Check HART communication with remote transmitter. If necessary, deactivate monitoring of the external HART signal in the 'Process Alarm / Alarm Limits / No HART Input Alarm' menu. Refer to HART® communication with remote transmitter on page 51.
C152.038 / Configuration	C152.010 / Operation	Alarm Simulation	An alarm is being simulated. Alarm simulation is switched on.	Switch off alarm simulation in the 'Diagnostics / Alarm Simulation' menu.
C151.037 / Configuration	C151.011 / Operation	Data Simulation	A process variable is being simulated. Simulation mode is activated.	In the 'Diagnostics / Simulation Mode' menu, deactivate simulation mode. If necessary, deactivate the simulation via the HART communication.

* Not for devices with Modbus® communication

** Not for devices with PROFIBUS PA® communication

... 11 Diagnosis / error messages

... Possible error messages

Operation outside of specifications (out of spec)

Error no. / Range HART / Modbus	PA / FF	Text on the LCD display	Cause	Remedy
S116.030 / Operation	S116.022 / Operation	Wrong Steam Type	Incorrect steam type configured.	Check the steam type setting in the 'Device Setup / Plant/Customized / Water/Steam Type' menu.
S115.036 / Operation	—	Flowrate > 103%	The flow rate exceeds the configured upper range value by more than 3 %.	Increase the upper range value in the 'Device Setup / Sensor' menu.
S114.004 / Operation	S114.012 / Operation	Max Flowrate Alarm	The present flow rate is greater than the max. alarm configured.	Reduce the flow rate or increase the value for the max. alarm.
S113.010 / Operation	S113.013 / Operation	Min Flowrate Alarm	The present flow rate is lower than the min. alarm configured.	Increase the flow rate or reduce the value for the min. alarm.
S112.005 / Operation	S112.014 / Operation	Max Int. Temp Alarm	The measuring medium temperature is greater than the max. alarm configured.	Check the measuring medium temperature or increase the value for the max. alarm.
S111.011 / Operation	S111.015 / Operation	Min Int. Temp Alarm	The measuring medium temperature is lower than the min. alarm configured.	Check the measuring medium temperature or reduce the value for the min. alarm.
S110.035 / Operation	S110.016 / Operation	Low Flow Cutoff	The instantaneous flow rate is lower than the set leak flow volume.	Increase flow rate or value for the low flow cut-off in the menu 'Device Setup / Transmitter / Low Flow Cutoff'.
S109.026 / Operation	S109.017 / Operation	Re. Out of Range	The Reynolds number (Re) is lower than the set minimum alarm. Measuring accuracy is reduced if the Reynolds number (Re) falls below a specific value. Refer to Measuring range table on page 150.	Check the device set-up. Increase the flow rate. If necessary, reduce the value for the min. alarm.
S108.012 / Operation*	—	Current Output Saturated	The current output has fallen below or exceeded the measuring range limits. The process value output via the current output is outside of the set limits (3.8 to 20.5 mA).	Check the device set-up. Check the measuring range limit setting for the current output in the 'Input/Output / Current Out' menu and adjust if necessary.
S107.006 / Operation*	—	AI Cut Off	External switching off of output via analog input is active.	Check analog input value. Check the switching point setting for the external output switch-off in the 'Input/Output / Field Input / Ext.Cutoff Trigger' menu and adjust if necessary.

* Not for devices with Modbus® communication

** Not for devices with PROFIBUS PA® communication

Error no. / Range		Text on the LCD display	Cause	Remedy
HART / Modbus	PA / FF			
S106.003 / Operation*	—	AI Out of Range	The signal at the analog input is outside the permissible limits of 3.8 to 20.5 mA.	Check analog input value.
S105.034 / Operation	—	Min Housing T Alarm	The ambient temperature of the transmitter is outside permissible limits.	Ensure that the ambient temperature of the transmitter is within permissible limits.
S104.033 / Operation*	—	Flowrate Cutoff		Check the device installation in accordance with Installation conditions on page 35.
S103.025 / Operation	S103.018 / Operation	Pulse Output Cutoff	Incorrect configuration of pulse output. The maximum pulse rate has been exceeded.	Check the pulse rate in the 'Input/Output / DO Function / Setup Pulse Out' menu and adjust if necessary.
S102.007 / Operation*	—	Max Pressure Alarm	The measuring medium pressure is greater than the max. alarm configured.	Check the measuring medium pressure or increase the value for the max. alarm.
S101.013 / Operation*	—	Min Pressure Alarm	The measuring medium pressure is lower than the min. alarm configured.	Check the measuring medium pressure or reduce the value for the min. alarm.

Maintenance

Error no. / Range		Text on the LCD display	Cause	Remedy
HART / Modbus	PA / FF			
M054.043 / Operation	M54.019 / Operation	NV Replace Warning	The communication board or frontend board has been replaced without downloading the system data. The system data was not downloaded correctly.	Download the system data, see Replacing the transmitter, downloading system data on page 147.
M053.032 / Operation	—	Voltage Warning	The supply voltage to the transmitter is outside permissible limits.	Check the supply voltage at the transmitter terminals. Check the length of the power supply cable, see Current output / HART output on page 50. Check the external power supply and replace if necessary.
M052.031 / Operation	M53.020 / Operation	Maintenance Warning	Maintenance interval reached.	Adjust the maintenance interval or contact ABB Service to have the device recalibrated.
M051.018 / Operation	M52.021 / Operation	Sensor Not Calibrated	The sensor has not been calibrated or the calibration status has not been set to 'Calibrated'.	Contact ABB Service to have the device recalibrated.

* Not for devices with Modbus® communication

** Not for devices with PROFIBUS PA® communication

... 11 Diagnosis / error messages

... Possible error messages

Response of the outputs to error messages

Error no. / Range	Error text	Current output	Digital output	Error maskable?
F217.041 / Electronics	— CO Readback High	High Alarm	Collective alarm	No
F216.042 / Electronics	— CO Readback Low	Low Alarm	Collective alarm	No
F215.020 / Electronics	F215.001 / Electronics Sensor Comm Error	High Alarm or Low Alarm, depending on parameter 'Iout at Alarm'.	Collective alarm	No
F214.019 / Electronics	F214.002 / Sensor Sync. Signal Error		Collective alarm	No
F213.000 /	Sensor F213.003 / Sensor Sig. Sensor Fault		Collective alarm	No
F212.001 / Sensor*	F212.004 / Sensor Int. T Sensor Fault		Collective alarm	Menu 'Individual Masking'.
F211.002 /	Sensor F211.005 / Sensor Vbr. Sensor Fault		Collective alarm	No
F210.016 / Electronics	F210.006 / Electronics Bad SNR		Collective alarm	No
F209.017 / Electronics	F209.007 / Electronics Sensor NV Error		Collective alarm	No
F208.044 / Electronics	F207.008 / Electronics Sensor RAM Fault		Collective alarm	No
F207.023 / Electronics	— Transmitter NV Error		Collective alarm	No
F203.040 / Electronics*	— Current Output Fault		Collective alarm	No
C202.024 / Electronics*	— AI Comm Error		Collective alarm	No
—	C160.000 / Operation** Not Remove FF Check	—	No change	No
C155.045 / Configuration	S155.023 / Operation Totalizer Stop	Current value - no change.	No change	Menu 'Group Masking'.
C154.039 / Configuration*	— Fixed Current Output	Fixed value set by simulation.	No change	Menu 'Group Masking'.
—	C153.009 / Operation No AO Input	—	No change	Menu 'Individual Masking'.
C153.047 / Configuration	— No HART Burst In	Current value - no change.	No change	Menu 'Group Masking'.
C152.038 / Configuration	C152.010 / Operation Alarm Simulation	*	**	Menu 'Group Masking'.
C151.037 / Configuration	C151.011 / Operation Data Simulation	Current or simulated value. Parameter "Simulation Mode / Current Out".	Current or simulated value. Parameter "Simulation Mode / Logic on DO".	Menu 'Group Masking'.

* If the Int. T Sensor Fault alarms or Flowrate > 103% are simulated, the current output assumes the value for High Alarm or Low Alarm, depending on the 'Iout at Alarm' parameter. The currently measured value is output for all other alarms.

** If the Int. T Sensor Fault, Flowrate > 103%, Max Flowrate Alarm, Min Flowrate Alarm alarms or Low Flow Cutoff are simulated, the digital output assumes the status, depending on the 'Alarm Config' parameter. The status remains unchanged for all other alarms.

Error no. / Range		Error text	Current output	Digital output	Error maskable?
S116.030 / Operation	S116.022 / Operation	Wrong Steam Type	Current value - no change.	No change	Menu 'Group Masking'.
S115.036 / Operation	—	Flowrate > 103%	High Alarm or Low Alarm, depending on parameter 'Iout at Alarm'.	Collective alarm	Menu 'Individual Masking'.
S114.004 / Operation	S114.012 / Operation	Max Flowrate Alarm	Current value - no change.	Depending on parameter 'Max Flowrate Alarm'.	Menu 'Individual Masking'.
S113.010 / Operation	S113.013 / Operation	Min Flowrate Alarm	Current value - no change.	Depending on parameter 'Min Flowrate Alarm'.	Menu 'Individual Masking'.
S112.005 / Operation	S112.014 / Operation	Max Int. Temp Alarm	Current value - no change.	Depending on parameter 'Max Sensor T Alarm'.	Menu 'Individual Masking'.
S111.011 / Operation	S111.015 / Operation	Min Int. Temp Alarm	Current value - no change.	Depending on parameter 'Min Sensor T Alarm'.	Menu 'Individual Masking'.
S110.035 / Operation	S110.016 / Operation	Low Flow Cutoff	4 mA	Depending on parameter 'Flow Cutoff Alarm'.	Menu 'Individual Masking'.
S109.026 / Operation	S109.017 / Operation	Re. Out of Range	Current value - no change.	No change	Menu 'Group Masking'.
S108.012 / Operation	—	Current Output Saturated	Configured maximum current.	No change	Menu 'Group Masking'.
S107.006 / Operation	—	AI Cut Off	4 mA	No change	Menu 'Group Masking'.
S106.003 / Operation	—	AI Out of Range	Current value - no change.	No change	Menu 'Group Masking'.
S105.034 / Operation	—	Flowrate Cutoff	Current value - no change.	No change	Menu 'Individual Masking'.
S104.033 / Operation	—	Min Housing T Alarm	Current value - no change.	No change	Menu 'Individual Masking'.
S103.025 / Operation	S103.018 / Operation	Pulse Output Cutoff	Current value - no change.	No change	Menu 'Group Masking'.
S102.007 / Operation	—	Max Pressure Alarm	Current value - no change.	No change	Menu 'Group Masking'.
S101.013 / Operation	—	Min Pressure Alarm	Current value - no change.	No change	Menu 'Group Masking'.
M054.043 / Operation	M54.019 / Operation	NV Replace Warning	Current value - no change.	No change	Menu 'Group Masking'.
M053.032 / Operation	—	Voltage Warning	Current value - no change.	No change	Menu 'Group Masking'.
M052.031 / Operation	M53.020 / Operation	Maintenance Warning	Current value - no change.	No change	Menu 'Group Masking'.
M051.018 / Operation	M52.021 / Operation	Sensor Not Calibrated	Current value - no change.	No change	Menu 'Group Masking'.

... 11 Diagnosis / error messages

Malfunctions without error messages

Failure	Corrective action	
No flow measurement when there is a flow through the piping	General	See the general information in General Notes on page 136.
		Check whether the flow rate is within the selected measuring range limits of the device.
	Sensor	Check the measuring tube for damage, foreign matter, and deposits that could impair the flow profile. Clean the meter tube if necessary.
		Check the guide body, bluff body, and Piezo sensor in the meter tube for damage.
		Overheating of the Piezo sensor as a result of the permissible measuring medium temperature having been exceeded can damage the Piezo sensor and impair the measurement.
	Application	Check whether there is sufficient back pressure downstream of the device to prevent cavitation.
		Refer to Avoiding cavitation on page 37.
		For test purposes, increase the measuring medium pressure.
		For test purposes, increase / reduce the flow rate.
	Transmitter	Determine the sensor frequency in the 'Diagnostics / Sensor Freq' menu. The frequency must correspond with the requirements set out in the measuring range tables. Refer to Measuring range table on page 150.
		If the sensor frequency seems plausible, check the configuration of the transmitter and the electrical connection.
		Check the function of the outputs in the 'Diagnostics / Simulation Mode' menu.
		Check the configuration of the outputs in the 'Input/Output' menu.
Incorrect flow measurement when there is a flow through the piping	General	See the general information in Sensor on page 136.
		Check whether the flow rate is within the selected measuring range limits of the device.
	Sensor	Check the meter tube gaskets.
		Even very small leaks can cause a hissing noise and impair the measurement. In the event of low flow rates in relation to the nominal diameter, this results in excessively high flow rates being measured. Hardly any errors occur with higher flow rates.
		If necessary, tighten the flange screws or replace the gaskets.
		Check the measuring tube for damage, foreign matter, and deposits that could impair the flow profile. Clean the meter tube if necessary.
	Application	For test purposes, check the response of the device to changes in the flow.
	Installation	Check whether the inside diameters of the sensor and piping are different from one another.
		Check the inlet and outlet sections and the distances from setting equipment and pipe bends. Refer to Installation conditions on page 35.
		Check the distances from internal piping components such as pressure and temperature measuring points.
		Refer to Installation for external pressure and temperature measurement on page 37.
		Check whether valves are installed in the piping upstream of the sensor. Valves can disrupt the flow profile of the measuring medium and therefore impair the measurement.
		Valves can cause a hissing noise and impair the measurement.
	Refer to Installation of setting equipment on page 37.	

Error / Malfunction	Corrective action	
Incorrect flow measurement when there is a flow through the piping	Outgassing of measuring media and cavitation	<p>Check whether there is sufficient back pressure downstream of the device to prevent cavitation.</p> <p>Refer to Avoiding cavitation on page 37.</p> <p>For test purposes, increase the measuring medium pressure.</p> <p>Pressure variations in measuring media at high pressures and temperatures can result in outgassing. A typical example is a pressure variation from a high to a low pressure through a valve.</p>
	Pulsating measuring media	<p>Pumps can cause hydraulic oscillations of the measuring medium in the piping. The frequency of this oscillations can be within the range of measuring frequency and thus have an effect on the measuring accuracy.</p> <p>Take appropriate measures to suppress hydraulic oscillations in the measuring medium.</p> <p>When selecting the nominal diameter and device type of piston pumps, ensure that the pump frequency is below the minimum measuring frequency of the sensor.</p>
	Transmitter	<p>Determine the sensor frequency in the 'Diagnostics / Sensor Freq' menu. The frequency must correspond with the requirements set out in the measuring range tables. Refer to Measuring range table on page 150.</p> <p>If the sensor frequency seems plausible, check the configuration of the transmitter and the electrical connection.</p> <p>Check the function of the outputs in the 'Diagnostics / Simulation Mode' menu.</p> <p>Check the configuration of the outputs in the 'Input/Output' menu.</p>
	The flowmeter measures a flow rate even though there is no flow through the piping.	General
	Sensor	<p>Check the meter tube gaskets.</p> <p>Even very small leaks can cause a hissing noise and impair the measurement. In the event of low flow rates in relation to the nominal diameter, this results in excessively high flow rates being measured. Hardly any errors occur with higher flow rates.</p> <p>If necessary, tighten the flange screws or replace the gaskets.</p>
	Application	For test purposes, check the response of the device to changes in the flow.
	Installation	<p>Check the seal integrity of closed valves.</p> <p>Valves can cause a hissing noise and impair the measurement.</p>
Pulsating measuring media		<p>Pumps can cause hydraulic oscillations of the measuring medium in the piping. The frequency of this oscillations can be within the range of measuring frequency and thus have an effect on the measuring accuracy.</p> <p>Take appropriate measures to suppress hydraulic oscillations in the measuring medium.</p>
		In long lengths of piping, temperature changes and pressure fluctuations can cause movement in the measuring medium, which is then interpreted as flow.
Transmitter		<p>Determine the sensor frequency in the 'Diagnostics / Sensor Freq' menu. The frequency must correspond with the requirements set out in the measuring range tables. Refer to Measuring range table on page 150.</p> <p>If the sensor frequency seems plausible, check the configuration of the transmitter and the electrical connection.</p>
		Check the function of the outputs in the 'Diagnostics / Simulation Mode' menu.
		Check the configuration of the outputs in the 'Input/Output' menu.

12 Maintenance

Safety instructions

WARNING

Risk of injury due to live parts!

When the housing is open, contact protection is not provided and EMC protection is limited.

- Before opening the housing, switch off the power supply.

CAUTION

Risk of burns due to hot measuring media

The device surface temperature may exceed 70 °C (158 °F), depending on the measuring medium temperature!

- Before starting work on the device, make sure that it has cooled sufficiently.

NOTICE

Damage to components!

The electronic components of the printed circuit board can be damaged by static electricity (observe ESD guidelines).

- Make sure that the static electricity in your body is discharged before touching electronic components.

Corrective maintenance work may only be performed by trained personnel.

- Before removing the device, depressurize it along with any adjacent lines or vessels.
- Check whether hazardous materials have been used as measuring medium before opening the device. Residual amounts of hazardous material may still be present in the device and could escape when it is opened.

Within the scope of operator responsibility, check the following as part of a regular inspection:

- pressure-carrying walls / pressure equipment liner
- the measurement-related function
- the leak tightness
- the wear (corrosion)

Cleaning

When cleaning the exterior of meters, make sure that the cleaning agent used does not corrode the housing surface and the seals.

To avoid static charge, a damp cloth must be used for cleaning.

Sensor

Essentially no maintenance is required for the sensor.

The following items should be checked annually:

- Ambient conditions (air circulation, humidity).
- Tightness of the process connections,
- Cable entries and cover screws,
- Operational reliability of the power supply, lightning protection, and station ground.

13 Repair

Repair and maintenance activities may only be performed by authorized customer service personnel.

When replacing or repairing individual components, use original spare parts.

Replacing the transmitter, downloading system data

The sensor is equipped with storage capacity — known as the SensorMemory — in which the sensor calibration data and transmitter settings are saved.

In case of a replacement of components, these system data must be loaded into the new component.

Loading of system data is controlled by the DIP switches on the communication board.

See **DIP switch on the HART® communication board** on page 64, **DIP switch on the PROFIBUS PA®- / FOUNDATION Fieldbus® communication board** on page 68 and **DIP switch on the PROFIBUS PA®- / FOUNDATION Fieldbus® communication board** on page 68.

Note

Depending on the model version (HART® / Modbus® / PROFIBUS®, FOUNDATION Fieldbus®), the positions and designations of the DIP switches may differ.

After you replace the complete transmitter or the communication board:

The system data must be transferred from the **sensor** to the **transmitter**.

1. Switch off the power supply.
2. Set DIP switch SW 1.2 (HART) / SW 1.1 (Modbus) / DIP 2 (PROFIBUS, FOUNDATION Fieldbus) to 'ON'.
3. Switch on the power supply.
4. Wait at least 60 seconds and then switch off the power supply.
5. Set DIP switch SW 1.2 (HART) / SW 1.1 (Modbus) / DIP 2 (PROFIBUS, FOUNDATION Fieldbus) to 'OFF'.
6. Switch on the power supply.

The system data has now been transferred from the sensor to the transmitter.

After you replace the sensor or the sensor board:

The system data must be transferred from the **transmitter** to the **sensor**.

1. Switch off the power supply.
2. Set DIP switch SW 1.2 (HART) / SW 1.1 (Modbus) / DIP 2 (PROFIBUS, FOUNDATION Fieldbus) to 'ON'.
3. Set DIP switch SW 1.3 (HART) / SW 1.2 (Modbus) / DIP 3 (PROFIBUS, FOUNDATION Fieldbus) to 'ON'.
4. Switch on the power supply.
5. Wait at least 60 seconds and then switch off the power supply.
6. Set DIP switch SW 1.2 (HART) / SW 1.1 (Modbus) / DIP 2 (PROFIBUS, FOUNDATION Fieldbus) to 'OFF'.
7. Set DIP switch SW 1.3 (HART) / SW 1.2 (Modbus) / DIP 3 (PROFIBUS, FOUNDATION Fieldbus) to 'OFF'.
8. Switch on the power supply.

The system data has now been transferred from the transmitter to the sensor.

Note

Check the device parameterization before restarting the process!

Returning devices

Use the original packaging or a secure transport container of an appropriate type if you need to return the device for repair or recalibration purposes.

Fill out the return form (see **Return form** on page 149) and include this with the device.

In accordance with the EU Directive governing hazardous materials, the owner of hazardous waste is responsible for its disposal or must observe the following regulations for shipping purposes:

All devices delivered to ABB must be free from any hazardous materials (acids, alkalis, solvents, etc.).

Address for returns:

Please contact Customer Center Service acc. to page 6 for nearest service location.

14 Dismounting and disposal

Dismounting

WARNING

Risk of injury due to process conditions.

The process conditions, for example high pressures and temperatures, toxic and aggressive measuring media, can give rise to hazards when dismantling the device.

- If necessary, wear suited personal protective equipment during disassembly.
- Before disassembly, make sure that the process conditions do not pose any safety risks.
- Depressurize and empty the device / piping, allow to cool and purge if necessary.

Bear the following points in mind when dismantling the device:

- Switch off the power supply.
- Disconnect electrical connections.
- Allow the device / piping to cool and depressurize and empty. Collect any escaping medium and dispose of it in accordance with environmental guidelines.
- Use suited tools to disassemble the device, taking the weight of the device into consideration.
- If the device is to be used at another location, the device should preferably be packaged in its original packing so that it cannot be damaged.
- Observe the notices in **Returning devices** on page 34.

Disposal

Note



Products that are marked with the adjacent symbol may **not** be disposed of as unsorted municipal waste (domestic waste).

They should be disposed of through separate collection of electric and electronic devices.

This product and its packaging are manufactured from materials that can be recycled by specialist recycling companies.

Bear the following points in mind when disposing of them:

- As of 8/15/2018, this product will be under the open scope of the WEEE Directive 2012/19/EU and relevant national laws (for example, ElektroG - Electrical Equipment Act - in Germany).
- The product must be supplied to a specialist recycling company. Do not use municipal waste collection points. These may be used for privately used products only in accordance with WEEE Directive 2012/19/EU.
- If there is no possibility to dispose of the old equipment properly, our Service can take care of its pick-up and disposal for a fee.

15 Specification

Note

The device data sheet is available in the ABB download area at www.abb.com/flow.

16 Additional documents

Note

All documentation, declarations of conformity, and certificates are available in ABB's download area.

www.abb.com/flow

17 Appendix

Return form

Statement on the contamination of devices and components

Repair and/or maintenance work will only be performed on devices and components if a statement form has been completed and submitted.

Otherwise, the device/component returned may be rejected. This statement form may only be completed and signed by authorized specialist personnel employed by the operator.

Customer details:

Company:

Address:

Contact person:

Telephone:

Fax:

Email:

Device details:

Type:

Serial no.:

Reason for the return/description of the defect:

Was this device used in conjunction with substances which pose a threat or risk to health?

Yes No

If yes, which type of contamination (please place an X next to the applicable items):

biological

corrosive / irritating

combustible (highly / extremely combustible)

toxic

explosive

other toxic substances

radioactive

Which substances have come into contact with the device?

1.

2.

3.

We hereby state that the devices/components shipped have been cleaned and are free from any dangerous or poisonous substances.

Town/city, date

Signature and company stamp

... 17 Appendix

Measuring range table

FSV430, FSV450

Flow measurement for liquids (Water, 1 bar (a) 20 °C)

Nominal diameter	Flange	[m ³ /h]		[Usgpm]		[Hz]	
		QV _{min} DN ¹⁾	QV _{max} DN	QV _{min} DN ¹⁾	QV _{max} DN	Min. Frequency ²⁾	Max. Frequency ²⁾
DN 15 (½ in)	DIN	1.0	7.0	4.4	30.8	10	480
	ASME	1.0	7.0	4.4	30.8	12	640
DN 25 (1 in)	DIN	1.6	18.0	7	79	10	300
	ASME	1.6	18.0	7	79	8	440
DN 40 (1½ in)	DIN	2.4	48.0	10	210	10	300
	ASME	2.4	48.0	10	210	6	300
DN 50 (2 in)	DIN	3.1	75.0	14	330	4	220
	ASME	3.1	75.0	14	330	4.5	220
DN 80 (3 in)	DIN	9.0	170.0	40	748	3	150
	ASME	9.0	170.0	40	748	3	150
DN 100 (4 in)	DIN	10.0	270.0	44	1188	2	110
	ASME	10.0	270.0	44	1188	2	110
DN 150 (6 in)	DIN	24.0	630.0	106	2770	1	70
	ASME	24.0	630.0	106	2770	1.5	70
DN 200 (8 in)	DIN	70.0	1100.0	310	4840	0.8	44
	ASME	70.0	1100.0	310	4840	1	50
DN 250 (10 in)	DIN	70.0	1800.0	310	7920	0.6	40
	ASME	70.0	1800.0	310	7920	0.75	40
DN 300 (12 in)	DIN	135.0	2600.0	600	11400	0.6	30
	ASME	135.0	2600.0	600	11400	0.5	30

Flow measurement of gases and steam (Air, 1013 mbar (a) 20 °C)

Nominal diameter	Flange	[m ³ /h]		[ft ³ /min]		[Hz]	
		QV _{min} DN ¹⁾	QV _{max} DN	QV _{min} DN ¹⁾	QV _{max} DN	Min. Frequency ²⁾	Max. Frequency ²⁾
DN 15 (½ in)	DIN	7.4	42.0	4.4	24	60	2900
	ASME	7.4	33.0	4.4	19.4	60	3000
DN 25 (1 in)	DIN	12.2	150.0	7.2	88	50	2250
	ASME	12.2	120.0	7.2	70	60	2930
DN 40 (1 ½ in)	DIN	18.5	390.0	11	229	50	2400
	ASME	18.5	390.0	11	229	50	2400
DN 50 (2 in)	DIN	23.4	630.0	14	370	40	1850
	ASME	23.4	630.0	14	370	40	1850
DN 80 (3 in)	DIN	50.0	1380.0	30	810	30	1250
	ASME	50.0	1380.0	30	810	30	1250
DN 100 (4 in)	DIN	75.0	2400.0	45	1400	20	950
	ASME	75.0	2400.0	45	1400	15	920
DN 150 (6 in)	DIN	165.0	5400.0	100	3170	10	630
	ASME	165.0	5400.0	100	3170	10	590
DN 200 (8 in)	DIN	230.0	9600.0	140	5650	8	380
	ASME	230.0	9600.0	140	5650	8	440
DN 250 (10 in)	DIN	450.0	16300.0	270	9590	6	330
	ASME	450.0	16300.0	270	9590	7	360
DN 300 (12 in)	DIN	630.0	23500.0	370	13800	5	280
	ASME	630.0	23500.0	370	13800	5	280

1) For other media or other operating conditions please refer to a proper sizing to our ABB Product and Selection Assistant, www.abb.com/flow-selector.

2) Frequency range for full measuring range coverage. The effectively used frequency range can vary depending on medium conditions and device set-up. The frequency range covered by calibration can be found on the test report supplied with each device.

FSS430, FSS450**Flow measurement for liquids (Water, 1 bar (a) 20 °C)**

Nominal diameter	[m ³ /h]		[Usgpm]		[Hz]	[Hz]
	Qv _{min} DN ¹⁾	Qv _{max} DN	Qv _{min} DN ¹⁾	Qv _{max} DN	Min. Frequency ²⁾	Max. Frequency ²⁾
DN 15 (½ in)	0.49	2.5	2.2	11	6	310
DN 20 (¾ in)	0.64	4.0	2.8	17.6	4	200
DN 25 (1 in)	0.79	8.0	3.5	35.2	4	200
DN 32 (1¾ in)	1.00	16.0	4.4	70.4	3	160
DN 40 (1½ in)	1.2	20.0	5.3	88	2.5	120
DN 50 (2 in)	1.4	30.0	6.2	132	2	100
DN 80 (3 in)	2.3	120.0	10	528	2	100
DN 100 (4 in)	5.0	180.0	22	792	2	90
DN 150 (6 in)	8.0	400.0	35	1760	1	50
DN 200 (8 in)	18.0	700.0	79	3080	0.8	40
DN 300 (12 in)	60.0	1600.0	264	7040	0.5	30
DN 400 (16 in)	110.0	2500.0	484	11000	0.4	20

Flow measurement of gases and steam (Air, 1013 mbar (a) 20 °C)

Nominal diameter	[m ³ /h]		[ft ³ /min]		[Hz]	[Hz]
	Qv _{min} DN ¹⁾	Qv _{max} DN	Qv _{min} DN ¹⁾	Qv _{max} DN	Min. Frequency ²⁾	Max. Frequency ²⁾
DN 15 (½ in)	3.7	20.0	2.2	11.8	52	2440
DN 20 (¾ in)	4.8	44.0	2.8	25.9	52	2150
DN 25 (1 in)	6.0	90.0	3.5	53	52	2200
DN 32 (1¾ in)	8.0	230.0	4.7	135	52	2320
DN 40 (1½ in)	10.7	300.0	6.3	176	40	1830
DN 50 (2 in)	16.8	440.0	10	259	30	1480
DN 80 (3 in)	60.0	1160.0	36	682	20	960
DN 100 (4 in)	48.0	1725.0	28	1015	18	840
DN 150 (6 in)	150.0	3800.0	88	2236	10	510
DN 200 (8 in)	160.0	5800.0	94	3400	10	340
DN 300 (12 in)	420.0	13600.0	250	8000	4	220
DN 400 (16 in)	560.0	21500.0	330	12650	3	180

1) For other media or other operating conditions please refer for a proper sizing to our ABB Product and Selection Assistant PSA tool,

www.abb.com/flow-selector.

2) Frequency range for full measuring range coverage. The effectively used frequency range can vary depending on medium conditions and device set-up. The frequency range covered by calibration can be found on the test report supplied with each device.

... 17 Appendix

vFCC / ISED certification

FCC statement

This device complies with part 15 of the FCC Rules. Operation is subject to the following two conditions:

1. This device may not cause harmful interference, and
2. this device must accept any interference received, including interference that may cause undesired operation.

This equipment has been tested and found to comply with the limits for a Class B digital device, pursuant to part 15 of the FCC Rules. These limits are designed to provide reasonable protection against harmful interference in a residential installation.

This equipment generates, uses and can radiate radio frequency energy and, if not installed and used in accordance with the instructions, may cause harmful interference to radio communications. However, there is no guarantee that interference will not occur in a particular installation.

If this equipment does cause harmful interference to radio or television reception, which can be determined by turning the equipment off and on, the user is encouraged to try to correct the interference by one or more of the following measures:

- Reorient or relocate the receiving antenna.
- Increase the separation between the equipment and receiver.
- Connect the equipment into an outlet on a circuit different from that to which the receiver is connected.
- Consult the dealer or an experienced radio/TV technician for help.

ISED (Canada) regulatory information

This device contains licence-exempt transmitter(s)/receiver(s) that comply with Innovation, Science and Economic Development Canada's licence-exempt RSS(s).

Operation is subject to the following two conditions:

1. This device may not cause interference.
2. This device must accept any interference, including interference that may cause undesired operation of the device.

L'émetteur/récepteur exempt de licence contenu dans le présent appareil est conforme aux CNR d'Innovation, Sciences et Développement économique Canada applicables aux appareils radio exempts de licence.

L'exploitation est autorisée aux deux conditions suivantes:

1. L'appareil ne doit pas produire de brouillage;
2. L'appareil doit accepter tout brouillage radioélectrique subi, même si le brouillage est susceptible d'en compromettre le fonctionnement.

NOTICE

Changes or modifications to this unit not expressly approved by the party responsible for compliance could void the user's authority to operate the equipment.

Trademarks

HART is a registered trademark of FieldComm Group, Austin, Texas, USA

Ethernet-APL is a trademark of the FieldComm Group, ODVA Inc., OPC Foundation and PROFIBUS Nutzerorganisation e.V.

Modbus is a registered trademark of Schneider Automation Inc.

PROFIBUS and PROFIBUS PA are registered trademarks of PROFIBUS & PROFINET International (PI)

FOUNDATION Fieldbus is a registered trademark of FieldComm Group, Austin, Texas, USA.

Kalrez and Kalrez Spectrum are registered trademarks of DuPont Performance Elastomers.

Hastelloy C is a trademark of Haynes International

Notes

Notes

ABB Measurement & Analytics

For your local ABB contact, visit:
www.abb.com/contacts

For more product information, visit:
www.abb.com/flow

We reserve the right to make technical changes or modify the contents of this document without prior notice. With regard to purchase orders, the agreed particulars shall prevail.

ABB does not accept any responsibility whatsoever for potential errors or possible lack of information in this document.

We reserve all rights in this document and in the subject matter and illustrations contained therein. Any reproduction, disclosure to third parties or utilization of its contents – in whole or in parts – is forbidden without prior written consent of ABB.