

JUMO LOGOSCREEN nt

Paperless recorder with TFT display,
CompactFlash card, and
USB interfaces

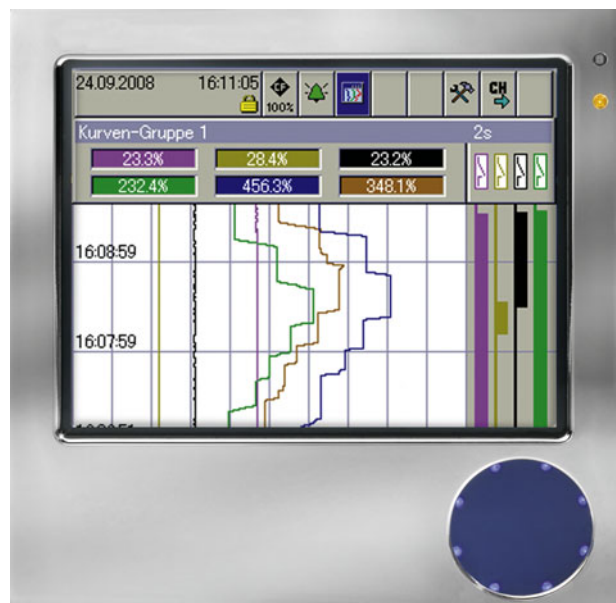

B 706581.1 Operating Instructions



Menu structure of the paperless recorder



⇒ Chapter 8 "Device Manager"



⇒ Chapter 7 "Memory Manager"



⇒ Chapter 6 "Alarm and Event Lists"



⇒ Chapter 4 "Visualization"



⇒ Chapter 5 "Memory Presentation (History)"

New device functions

The device software version 187.03.xx is replaced by version 187.04.xx. The following additional functions are available with the new version:

- additional horizontal recorder image; applicable for curve presentation, for binary presentation, for display of a closed batch, and for memory presentation
- Expansion of the external inputs from 24 to 54
- Expansion of the external texts from 9 to 27
- Time synchronization through SNTP
- New web server
- Modbus slave monitoring (timeout monitoring)

The device software can be checked in the menu *Device manager* → *Device info* → *Version* → *SW version*.

Contents

1	Introduction	7
1.1	Preface	7
1.2	Arrangement of the Documentation	8
1.3	Typographical Conventions	10
2	Instrument Description	13
2.1	Displays and Controls	15
3	Operating Principle	19
3.1	Operating Principle and Graphic Elements	19
3.2	Operating Example	24
3.3	Group and Plant Management (Batches)	26
4	Visualization	29
4.1	Activating the Operator Level	29
4.2	Overview of Header Lines	30
4.3	Curve Presentation	31
4.3.1	Vertical presentation	31
4.3.2	Horizontal presentation	32
4.4	Bar Graph Presentation	33
4.5	Text Picture Presentation	34
4.6	Process Image Presentation	35
4.7	Binary diagram presentation	35
4.7.1	Vertical presentation	36
4.7.2	Horizontal presentation	36
4.8	Reports	37
4.9	Batches/Plants	38
4.9.1	Current Batches	38
4.9.2	Completed Batches	40
4.9.3	Batch Control with Barcode Reader	41
4.10	Counters and Integrators	44
4.11	Comment Entry	45

Contents

5	Memory Presentation (History)	47
5.1	Vertical presentation	48
5.2	Horizontal presentation	50
6	Alarm and Event Lists	51
6.1	Call from One of the Visualization Modes	52
6.2	Call from the Memory Presentation	54
6.3	Symbols	54
7	Memory Manager	55
8	Device Manager	59
8.1	Close Device Manager	60
8.2	Log-in and Log-out	60
8.3	Device information	62
8.4	Device Audit Trail	67
8.5	Configuration	68
8.6	Parameterization	68
8.7	Service	69
9	Entering text and values	71
9.1	Text entry	71
9.1.1	Entering characters	71
9.1.2	Insert spaces	73
9.1.3	Delete character	73
9.1.4	Move cursor	73
9.1.5	Enter text from text list	73
9.1.6	Finish entry	73
9.1.7	Reject entry	74
9.2	Entry via selection field	74
9.3	Entering values	75
9.3.1	Whole numbers (integers)	75
9.3.2	Real numbers (floating point)	76

Contents

10	Web server	77
10.1	General	78
10.2	Online Visualization (All Visualizations Except Batches)	81
10.3	Three freely programmable HTML pages	83
10.4	Online Visualization of Current Batch Reports	84
10.5	QuadView	85
10.6	General information	88
10.7	Online visualization (all visualizations other than batches)	90
10.8	Online visualization of the current batch reports	91
10.9	QuadView	92
11	Appendix	95
11.1	Bar code	95
11.1.1	Batch control	95
11.1.2	Batch texts	96
12	Index	99

Contents

1.1 Preface



Please read this manual before commissioning the instrument. Keep the instructions in a place which is accessible to all users at all times.

Please assist us in improving these instructions where necessary.

Your comments will be appreciated.



If any difficulties should arise during commissioning, you are asked not to carry out any manipulations that could endanger your rights under the instrument warranty!

Please contact the nearest subsidiary or the head office in such a case.



When returning modules, assemblies or components, the regulations of EN 61340-5-1 and EN 61340-5-2 "Protection of electronic devices from electrostatic phenomena" must be observed. Use only the appropriate **ESD** packaging for transport.

Please note that we cannot accept any liability for damage caused by ESD.

ESD = Electro Static Discharge

1 Introduction

1.2 Arrangement of the Documentation

The documentation for this instrument is addressed to equipment manufacturers (OEMs) and users with appropriate technical expertise. It consists of the following parts:

Instrument documentation in printed form

B 706581.1 Operating instructions

The operating instructions are an extract from the operating manual and cover the basic operation of the paperless recorder.

B 706581.4(.1) Installation instructions

The installation instructions describe the installation of the recorder and the connection of the supply and signal cables. The instructions also contain a list of the technical data.

B 706581.4 Installation instructions for recorder with zinc die-cast panel

B 706581.4.1 Installation instructions for recorder with stainless steel panel

Instrument documentation in the form of PDF files

The “Instrument documentation in the form of PDF files” is on the CD that is included in the delivery.

B 706581.0 Operating manual

It contains information about commissioning, operation and parameterization on the instrument, as well as about the setup program (available as an option).

B 706581.1 Operating instructions

The operating instructions are an extract from the operating manual and cover the basic operation of the paperless recorder.

B 706581.2.0 Interface description (serial interfaces)

This provides information on communication (RS 232/RS 485) with supervisory systems.

Interface description (Ethernet interface)

This provides information on the connection of a paperless recorder to a company-internal network. This description is integrated into B 706581.2.0.

B 706581.2.3 Interface description (PROFIBUS-DP interface)

This provides information on the connection of a paperless recorder to a PROFIBUS-DP system.

B 706581.4(.1) Installation instructions

The installation instructions describe the installation of the recorder and the connection of the supply and signal cables. The instructions also contain a list of the technical data.

B 706581.4 Installation instructions for recorder with zinc die-cast panel

B 706581.4.1 Installation instructions for recorder with stainless steel panel

B 706581.6 Setup program

These instructions describe the functions of the setup program. The setup program is available as an accessory.

T 706581 Data sheet

The data sheet contains general information, the order details and, technical data.

B 709701.0 PC evaluation software PCA3000

The operating manual describes the operation and the features of the PC evaluation software.

The PC evaluation software serves to visualize and evaluate process data (measurement data, batch data, messages ...). The process data can be read in via the CompactFlash memory card, or made available through the PCC software.

B 709702.0 PCA communications software PCC

The operating manual describes the operation and features of the PCA Communications software.

The PCA Communications software is responsible for the data transfer from the paperless recorder to a PC, or across a network.

Internet



All documents are available for downloading at www.jumo.net

- * Start the product search on the home page.
- * Enter 706581 and start the search.
- * Select the paperless recorder.
- * Select the download section.
- * Download the PDF file.

1 Introduction

1.3 Typographical Conventions

Warning signs

The signs for **Danger** and **Caution** are used in this manual under the following conditions:



Danger

This symbol is used when there may be **danger to personnel** if the instructions are ignored or not followed correctly!



Warning

This symbol is used when there may be **damage to equipment or data** if the instructions are ignored or not followed correctly!



Warning

This symbol is used where special care is required when handling **components liable to damage through electrostatic discharge**.

Note signs



Note

This symbol is used when your **special attention** is drawn to a remark.



Reference

This symbol refers to **further information** in other manuals, chapters or sections.



Action instruction

This symbol indicates that an **action to be performed** is described.

The individual steps are marked by this asterisk, e.g.

* Rotate control knob

* Press control knob

Presentation modes

Screen texts

*Program
manager*

Texts that are displayed in the setup program are indicated by **italic script**.

Menu items

*Edit →
Device data*

Menu items in the setup and instrument software referred to in this operating manual are shown in italics. Menu name, menu item and submenu item are separated from each other by “→”.

1 Introduction

2 Instrument Description

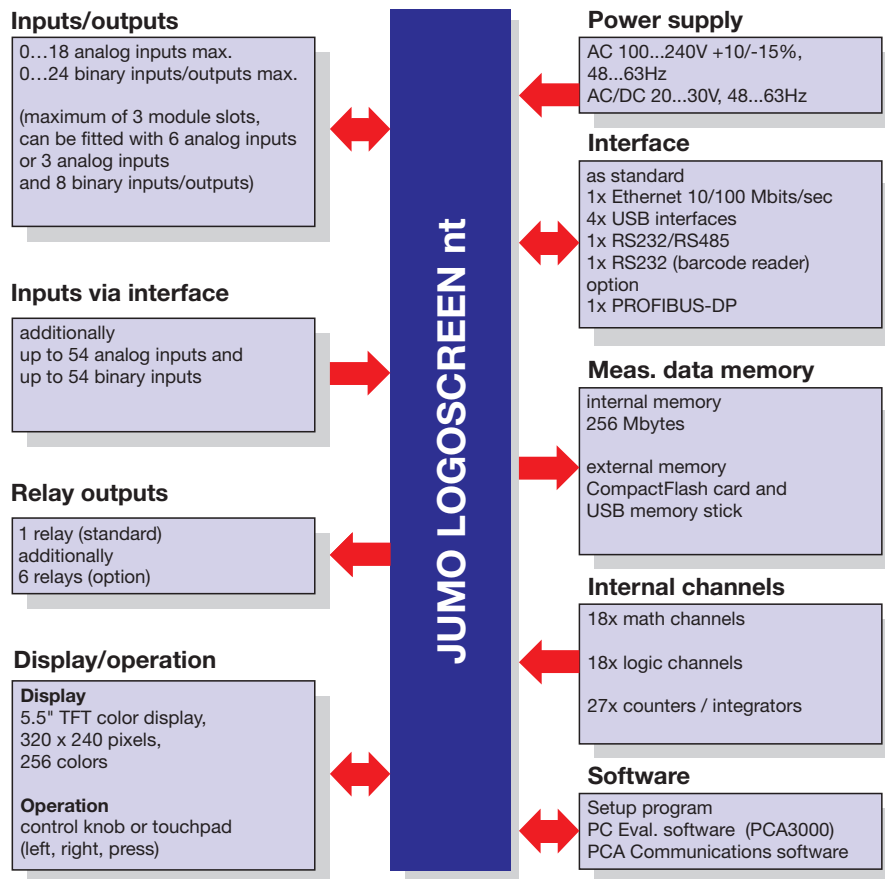





The connection diagram is described in the Installation Instructions B 706581.4(.1). When the paperless recorder is delivered, a printed version of the installation instructions is included.

- | | |
|--------------|---|
| B 706581.4 | Installation instructions for recorder with zinc die-cast panel |
| B 706581.4.1 | Installation instructions for recorder with stainless steel panel |

2 Instrument Description

Device features

		
Front panel	Zinc die-cast with lid	Stainless steel (enclosed)
Interfaces located on front panel	2x USB	None
External memory	CF-card located on front panel, maximum 4 GB	None
Operation	Control knob	Touchpad
Interfaces located on device's rear	2x USB, 1x RS232/RS485, 1x RS232, 1x Ethernet, 1x PROFIBUS-DP (option)	2x USB, 1x RS232/RS485, 1x RS232, 1x Ethernet, 1x PROFIBUS-DP (option)
Special features	Tested acc. to KTA 3505	EC type-examination Ex label  II 2G Ex px IIC  II 2D Ex px IIIC IP65

2 Instrument Description

2.1 Displays and Controls

Recorder with zinc die-cast panel

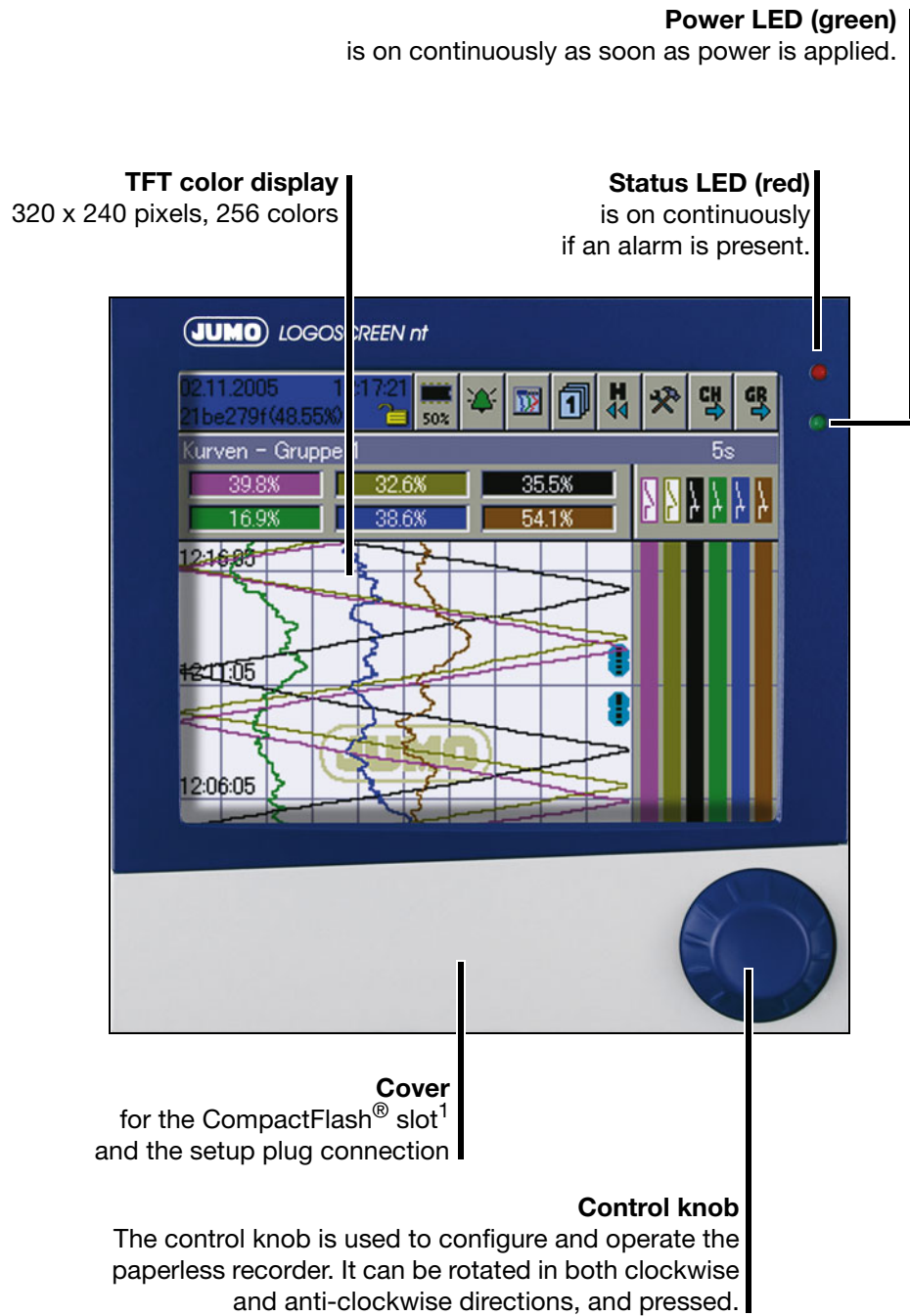

¹. CompactFlash® is a registered trademark of the SanDisk Corporation.

2 Instrument Description

Recorder with zinc die-cast panel

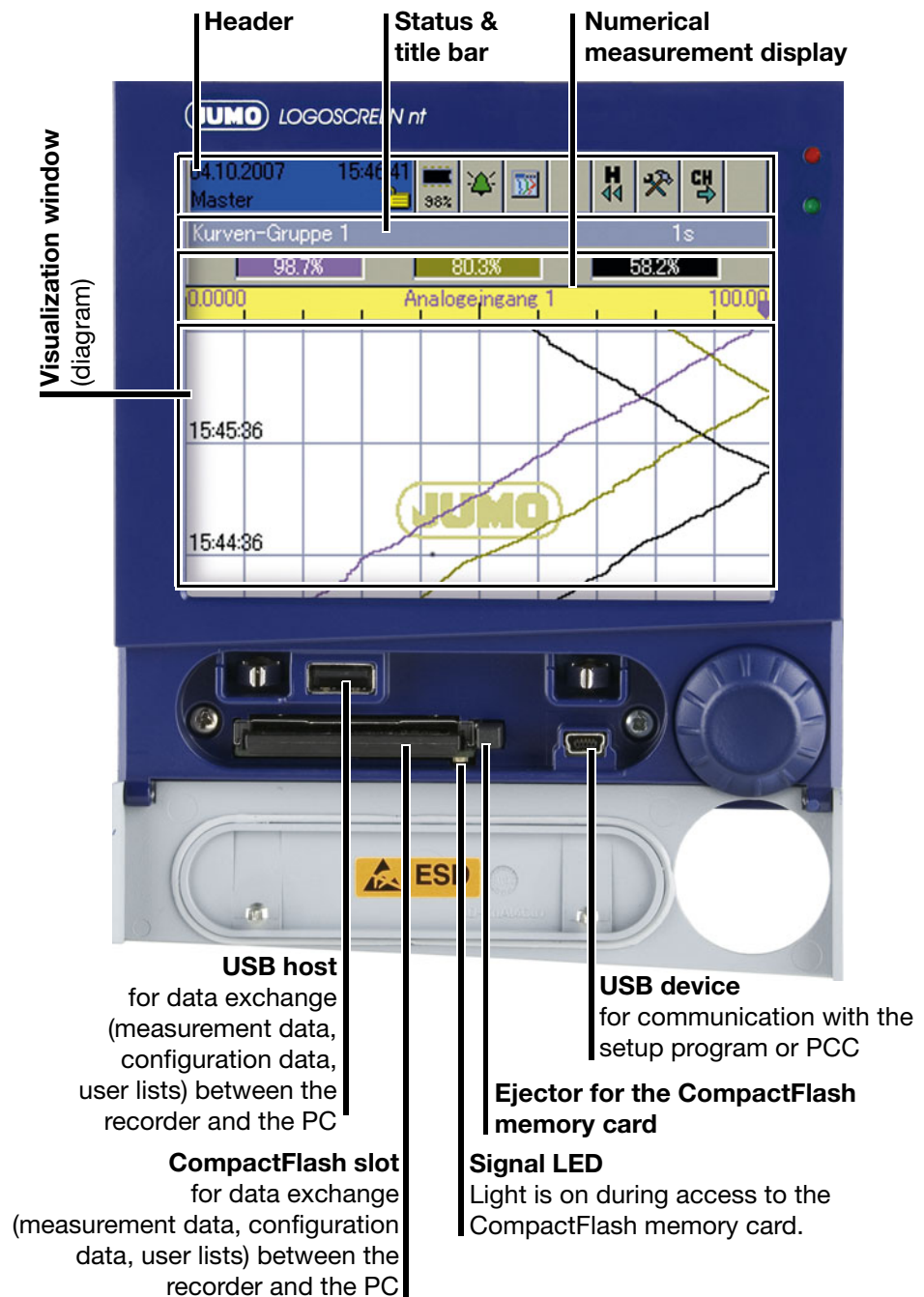

The CompactFlash memory card must not be removed during access (signal LED is on).

The USB interfaces are **not** designed for continuous use.



The life of the background illumination can be prolonged by using the parameter "Screen off".

2 Instrument Description

Recorder with stainless steel panel

Power LED (green)
is on continuously as soon as power is applied.

TFT color display
320 x 240 pixels, 256 colors

Status LED (red)
is on continuously if an alarm is present.

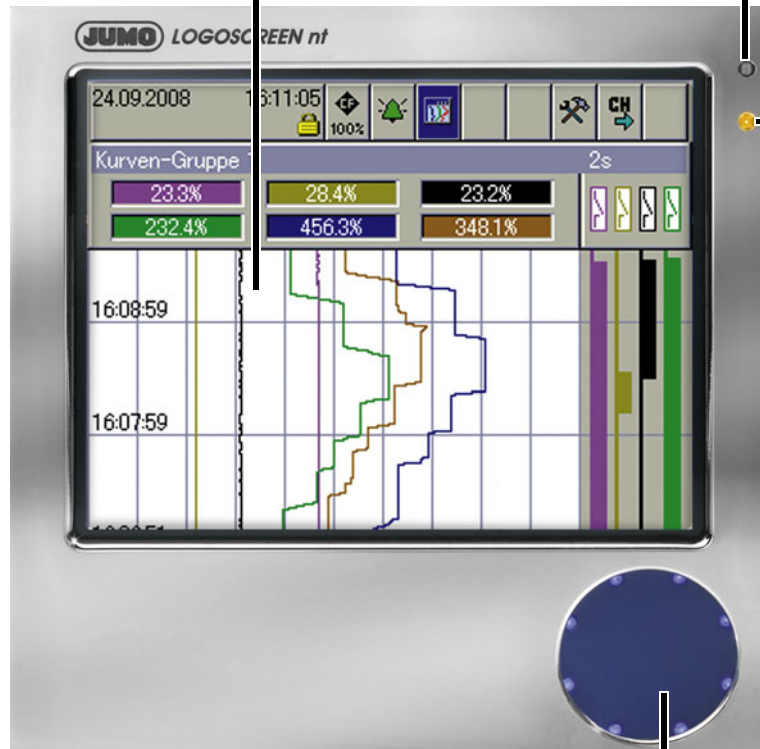

Touchpad
The touchpad is used to configure and operate the recorder. A circular motion with a finger at the outer edge has the same effect as the turning of the control knob. Tapping the middle of the touchpad has the same effect as when the control knob is pressed.

All descriptions of the control knob in this operating manual also apply to the touchpad.



For recorders with a stainless steel panel (extra code 444) the CompactFlash memory card is not available as external memory. The measured data can be saved through one of the interfaces or through a USB flash drive (on the rear side).

No interfaces at the front panel are available.

The installation instructions from B 706581.4.1 are to be heeded and complied with.

2 Instrument Description

3.1 Operating Principle and Graphic Elements

Header

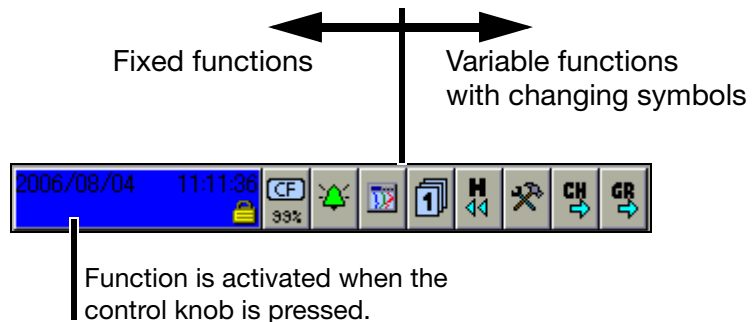

The functions of the paperless recorder are selected in the header. The selected function is indicated by a blue background.

Recorder with control knob



- Function selection by rotating the control knob (to right or left).



- Function is activated by pressing the control knob.

Recorder with touchpad (stainless steel front panel)



- Function selection through a circular motion with a finger at the outer edge of the touchpad (when activating the circular motion, two of the eight LEDs in the touchpad are on).



- Function selection by tapping the middle of the touchpad (all LEDs in the touchpad are on).

The symbols (for the variable functions) vary according to the function that is currently active.

The following diagram shows the header for normal display when the vertical diagram (curve display) has been selected.

3 Operating Principle

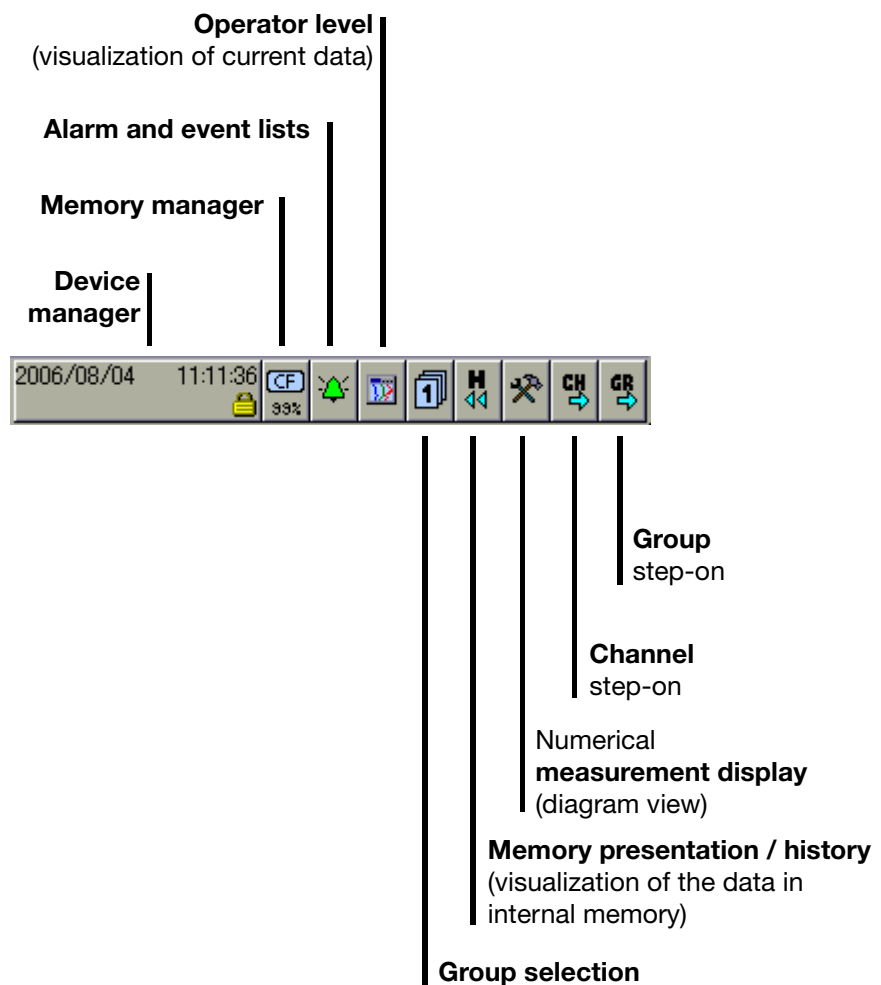

Device manager	⇒ Chapter 8
Memory manager	⇒ Chapter 7
Alarm and event lists	⇒ Chapter 6
Operator level (visualization)	⇒ Chapter 4
Group selection	⇒ See "Group selection" on Page 31.
Memory presentation (History)	⇒ Chapter 5
Numerical measurement display	⇒ See "Numerical measurement display (diagram view)" on Page 22. ⇒ See "Numerical measurement display" on Page 32.
Channel step-on	⇒ See "Channel step-on" on Page 37.
Group step-on	⇒ See "Group step-on" on Page 37.

3 Operating Principle

Status and title bar

This line (bar) shows alarm and error messages, as well as general information, and information about the active representation mode (e.g. sampling rate). It is automatically blanked out by the system, if necessary.

If the text is shown in red, this indicates an error message.



Sampling rate and operating mode

5s = normal mode

1s ! = event mode

1s 🕒 = timed mode



Data are currently being read by the PCA Communications software PCC.



Data are currently being transferred to the CF card.

Caution: Do not remove CF card!

3 Operating Principle

Numerical measurement display (diagram view)

The numerical measurement display is available for the presentation modes:

- Curves,
- history (of the curve presentation) and
- digital diagram

available.

In the **curve presentation**, the numerical display can be switched on or off. This switching on or off also applies to the history presentation.



An alarm for a channel is shown in red (HIGH alarm) or orange (LOW alarm). The colors can be configured in the setup program.

If the numerical measurement display is switched on in the **history (of the curve presentation)**, you can switch between MIN and MAX display. Whether or not MIN and MAX values are both available at the same time, depends on the settings for the group operating mode.







In the **binary presentation**, the diagram header can be switched on and off.

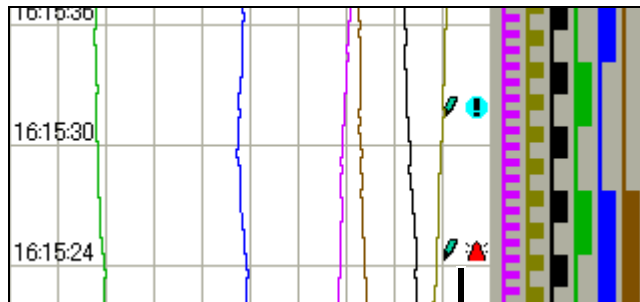

Visualization window (diagram)



Symbols for data acquisition:

-  Comment has been entered
-  Event occurred
-  Alarm is no longer present
-  Alarm has been signaled

In the visualization window, the measurement data are shown in graphical form. Alarms are indicated by a red or orange color for the curve (can be configured in the setup program).

Communication with the operator (device configuration, checking alarm and event lists etc.) also takes place via the visualization window.

3 Operating Principle

3.2 Operating Example

Start The normal display is active.

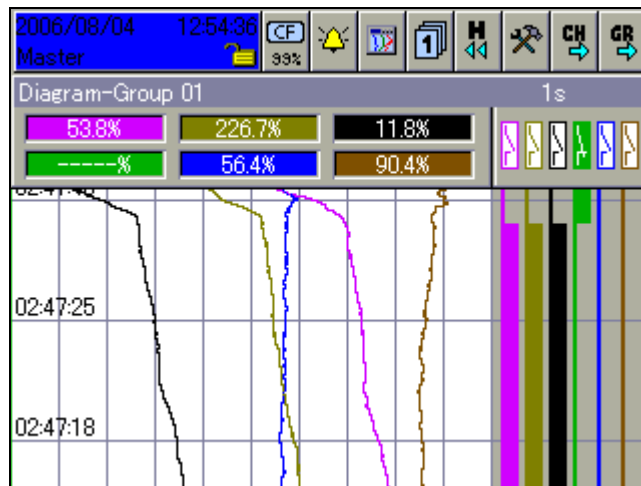

Operation



* Select the operator level by rotating the control knob.



* Activate the operator level by pressing the control knob.

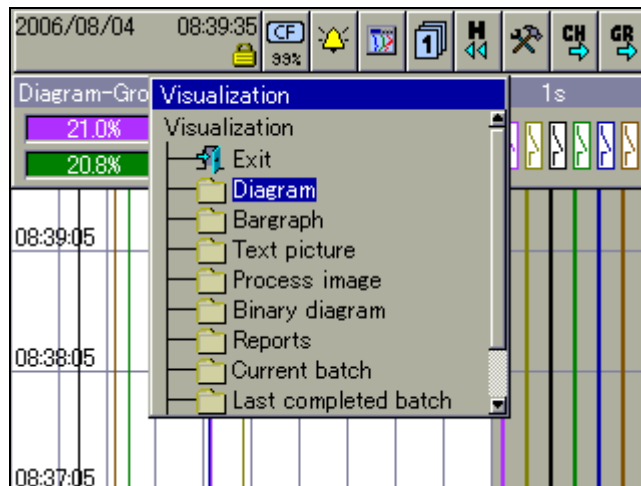

3 Operating Principle



- * Select the operator level by rotating the control knob.

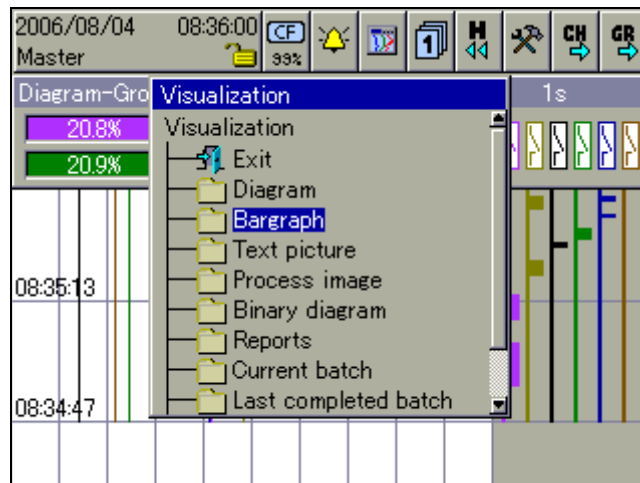

- * Activate the bar graph presentation by pressing the control knob.

Result

The bar graph presentation starts.

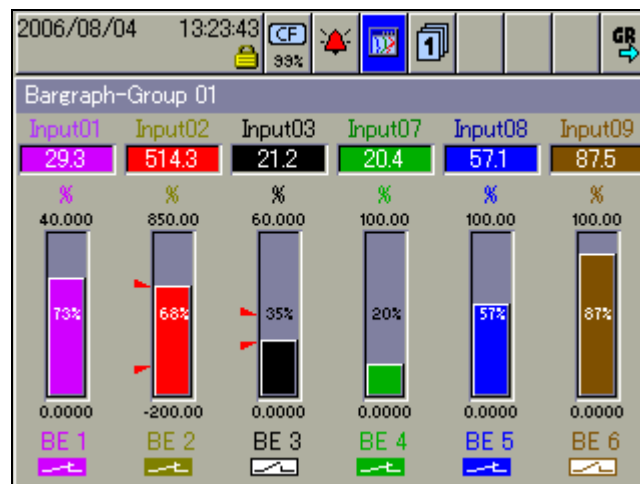

3 Operating Principle

3.3 Group and Plant Management (Batches)

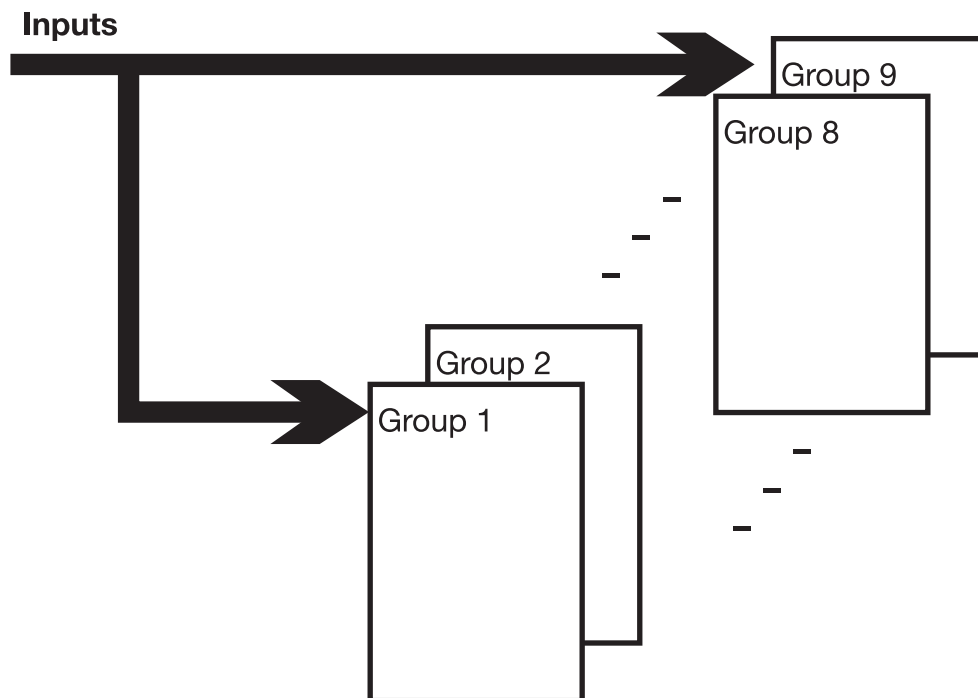

Within the recorder, all analog inputs, binary inputs, counters and integrators, are collected together into groups. A maximum of nine groups is available as a total. Each group can consist of a maximum of 6 analog inputs, 6 binary inputs (or outputs), and 4 counters/integrators.

The visualization and storage of the analog inputs and binary inputs (outputs) is always made on a group basis.

If plants (batches) are used, the groups have fixed assignments to the plants (batches).

Plant number	Group	Plant (batch)
0	1 ... 9	None
1	1 ... 9	1
2	1 ... 3 4 ... 6 7 ... 9	1 2 Not assigned
3	1 ... 3 4 ... 6 7 ... 9	1 2 3

3 Operating Principle



In order for a batch to be usable, its main group must be active (status = “Display” or “Display, save”) and at least one analog channel in the group must be assigned.

Batch for plant	Main group
1	1
2	4
3	7

The number of plants is configured through the parameter *Device manager* → *Configuration* → *Batches/plants* → *Gen. plant parameters* → *Number of plants*.

3 Operating Principle

4.1 Activating the Operator Level

The type of visualization (curve presentation, bar graph etc.) is selected at the operator level. Note that the appearance of the operator level can be influenced by the configuration.

- * Select the operator level by rotating the control knob.
- * Activate the operator level by pressing the control knob.



Operator level

You can alter the visualization after activating the operator level.

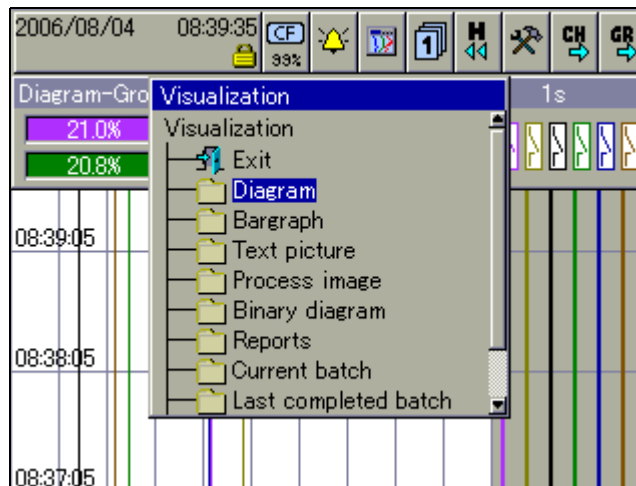

The functions in the header line will change, depending on the visualization. The following types of visualization are available:

Curves	⇒ Chapter 4.3
Bar graph	⇒ Chapter 4.4
Text picture	⇒ Chapter 4.5
Process image	⇒ Chapter 4.6
Binary	⇒ Chapter 4.7
Report	⇒ Chapter 4.8
Batch	⇒ Chapter 4.9
Counters/integrators	⇒ Chapter 4.10
Comment entry	⇒ Chapter 4.11

4 Visualization

4.2 Overview of Header Lines

Curve presentation (diagram)	
Bar graph presentation	
Text picture presentation	
Process image presentation	
Binary presentation	
Reports	
Batches (current)	
Batches (completed)	
Counters and integrators	

Comment entry The comment entry does not have its own header. The current header will remain when this function is activated. The comment that has been entered is placed in the event list.



The first four functions in the header are identical for all visualizations. These are supervisory functions (see "Header" on page 19).

Differences only arise in the last five functions.

4.3 Curve Presentation

For this type of display one distinguishes between vertical and horizontal presentation. Only one of the two presentation types can be active for all groups.

- ⇒ Configuration → Screen → Show diagrams
- ⇒ Configuration → Screen → Diagram display

4.3.1 Vertical presentation

In the display, signals are continuously displayed on the screen running from top to bottom.

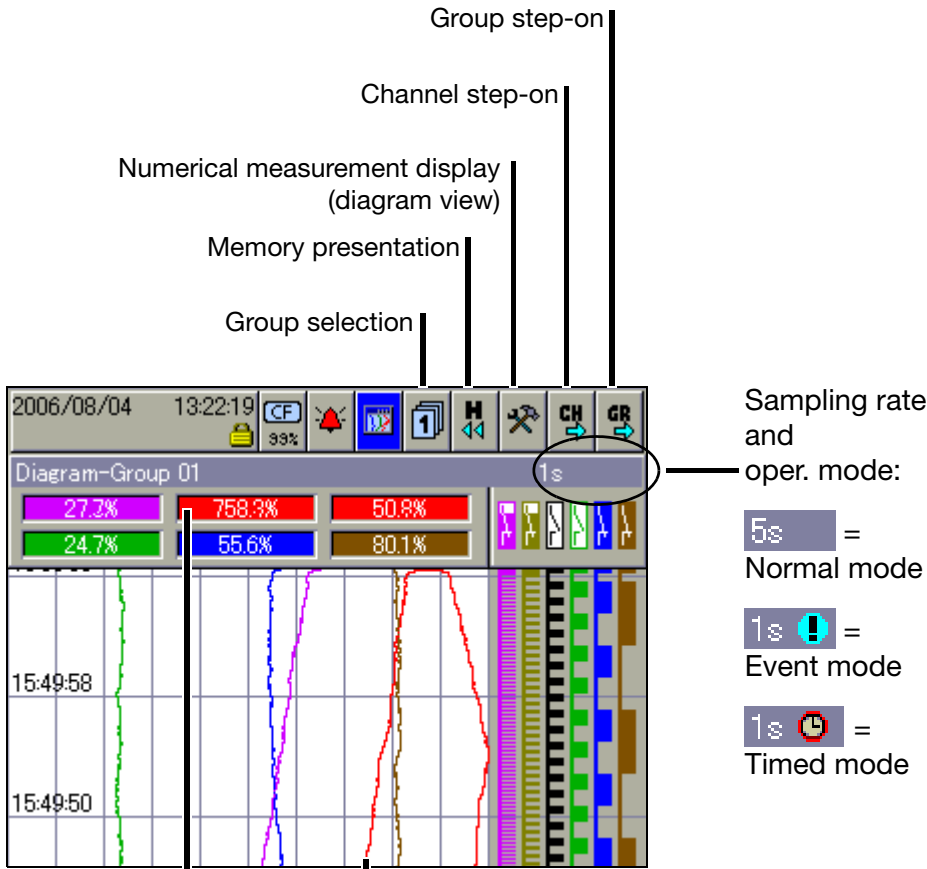

An alarm (Alarm 1 or Alarm 2) is indicated by a red or orange curve color. The colors can be configured in the setup program.

An alarm (Alarm 1 or Alarm 2) is indicated by an orange or a red background. The colors can be configured in the setup program.

Group selection You can use this function to directly select and display any one of the groups.

4 Visualization

Memory presentation This function starts the presentation of the data that are available in the history memory.

⇒ Chapter 5 "Memory Presentation (History)"

Numerical measurement display This function is used to switch the numerical measurement display (diagram header) and binary traces on or off, as well as to activate the envelope display.

Channel step-on This function activates the scaling display. Repeated activation steps through the scaling for the channels within the group, and then blanks it out again.

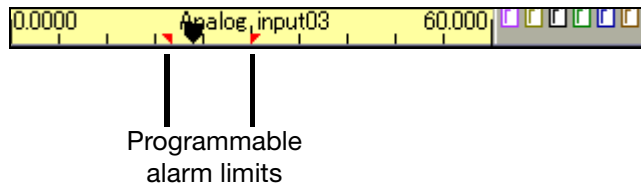

Group step-on Unlike "Group selection", where any group can be selected, this function is used to select the groups one after another.

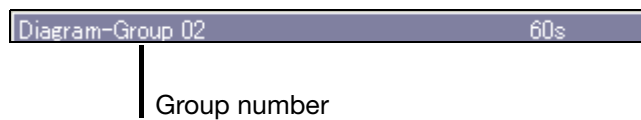

4.3.2 Horizontal presentation

In the display, signals are continuously displayed on the screen running from right to left.

The same functions as for the vertical presentation apply.

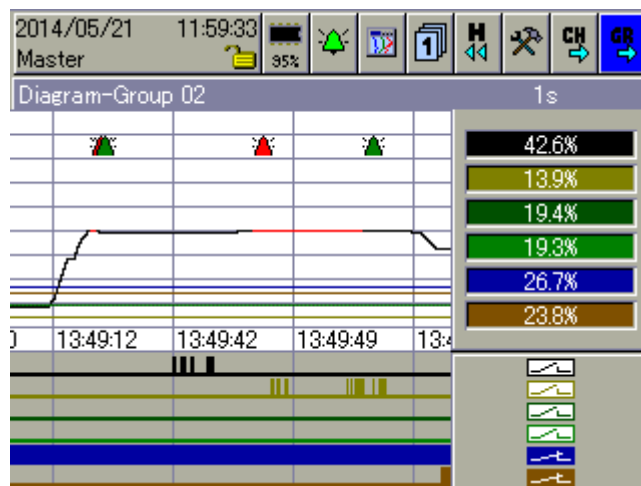

4.4 Bar Graph Presentation

In this visualization mode, the analog inputs are presented both numerically and in bar graph form. In addition to the analog channels, the digital inputs can also be visualized at the bottom of the display.

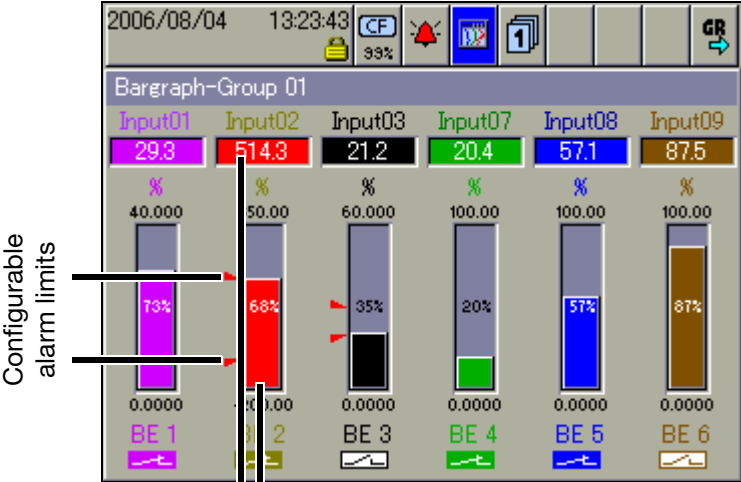

An alarm (Alarm 1 or Alarm 2) is indicated by an orange or red background. The colors can be configured in the setup program.

If only digital channels are to be presented, then Chapter 4.7 "Binary diagram presentation" is recommended.

4 Visualization

4.5 Text Picture Presentation

In the presentation, the analog channels are presented numerically, together with the channel name and the channel description. In addition to the analog channels, the digital inputs can also be visualized at the right-hand edge of the display.

Group presentation

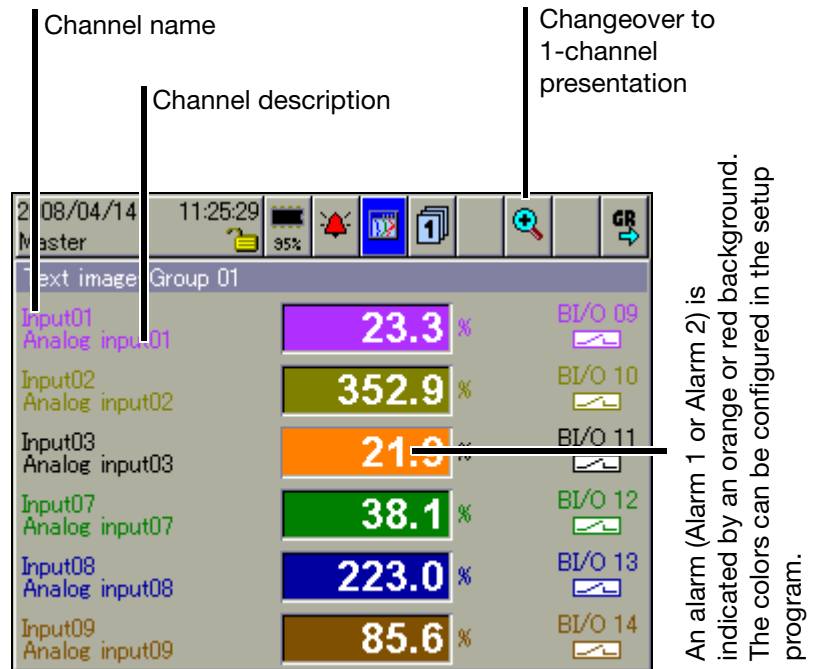

1-channel presentation

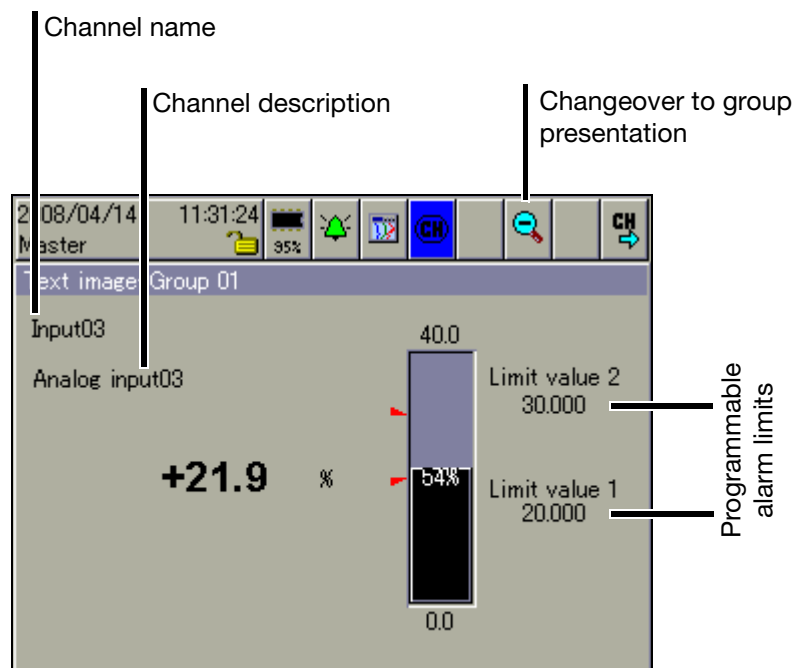

4.6 Process Image Presentation

The display shows selected measurement signals and background pictures in a maximum of nine process images. The setup program is used to prepare and configure the images.

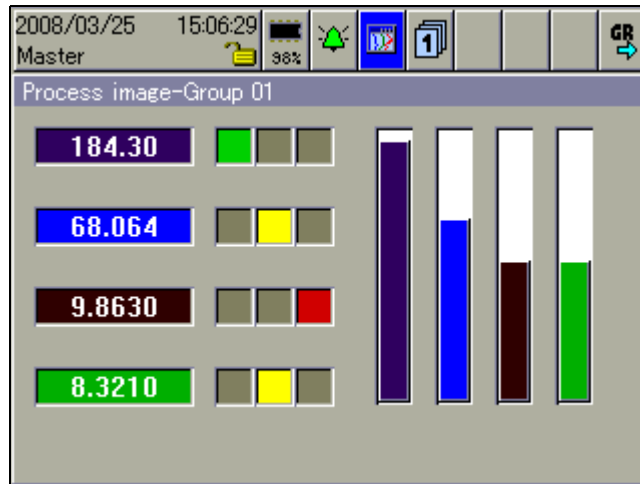

Each process image can be freely configured by the user. One background image (316 × 188 pixel) and 25 objects (analog/binary signals, icons, texts, bars) can be used per process image. Further information can be obtained from the instructions on the setup program (B 706581.6).

4.7 Binary diagram presentation

In the display the analog channels are dispensed with; only the binary channels and signals are visualized.

For this type of display one distinguishes between vertical and horizontal presentation. Only one of the two presentation types can be active for all groups.

⇒ *Configuration* → *Screen* → *Show binary image*

⇒ *Configuration* → *Screen* → *Diagram display*

4 Visualization

4.7.1 Vertical presentation

In the display, signals are continuously displayed on the screen running from top to bottom.

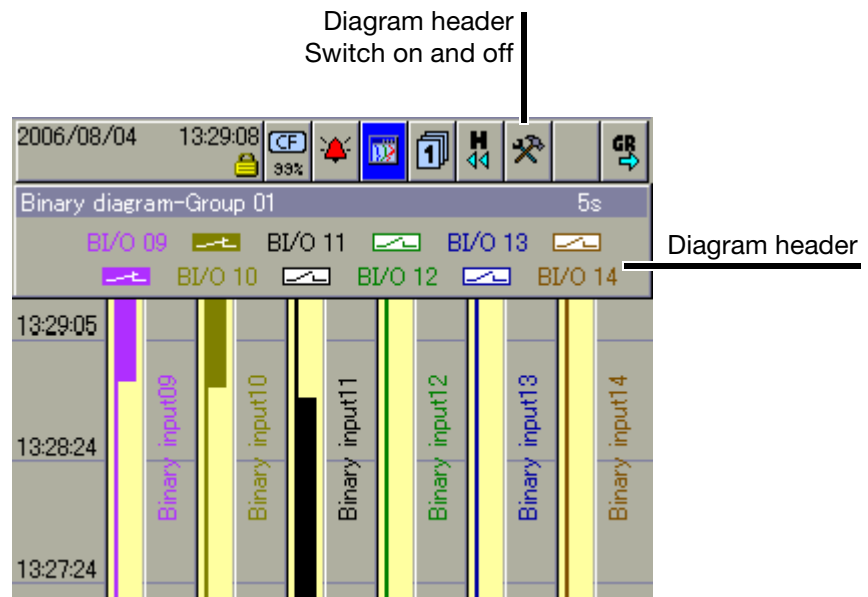

4.7.2 Horizontal presentation

In the display, signals are continuously displayed on the screen running from right to left.

The same functions as for the vertical presentation apply.

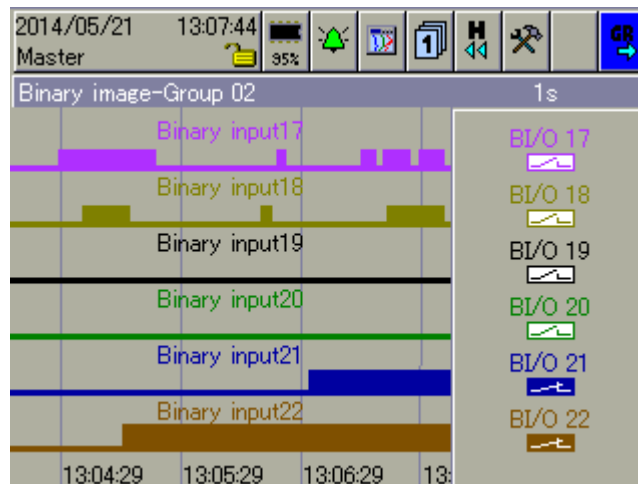

4.8 Reports

Each one of the reports covers all the analog channels in a group. Each group has its own configurable report.

The current reports are visualized in the presentation.

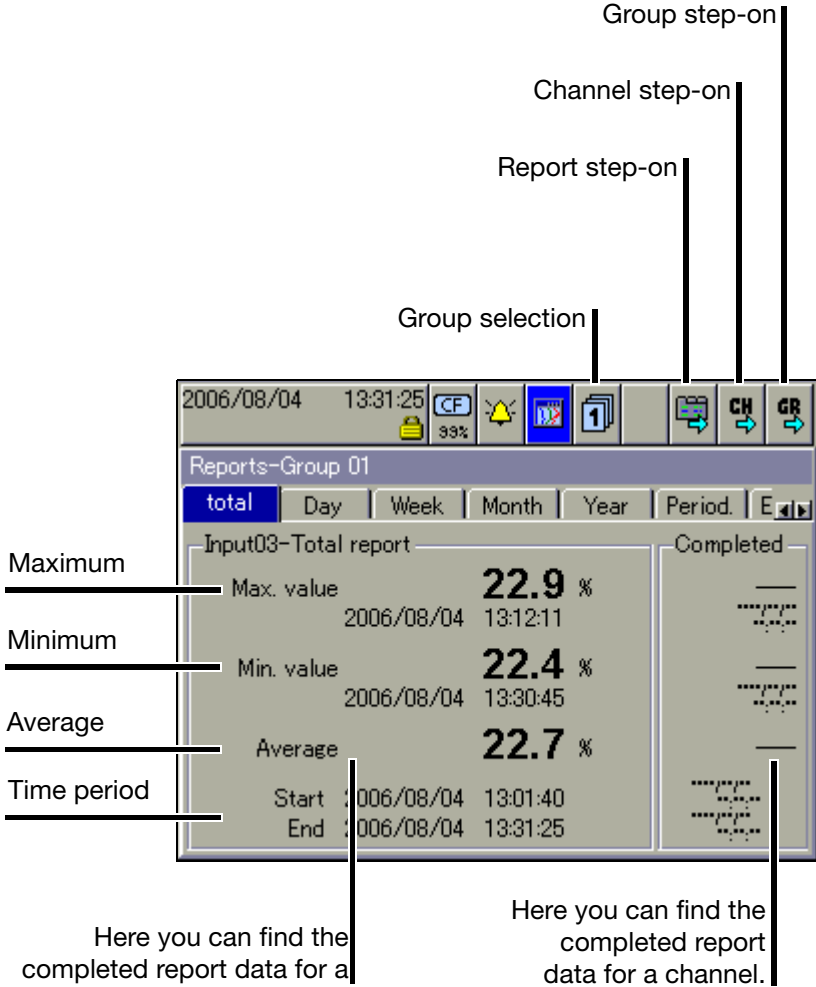

- Group selection** You can use this function to directly select any one of the groups and display the report data.
- Report step-on** This function is used to switch between the various types of report for the current channel.
- Channel step-on** This function can be used to switch between the individual channels of the group that is currently active.
- Group step-on** Unlike “Group selection”, where any group can be selected, this function is used to select groups one after another.

4 Visualization

4.9 Batches/Plants

When recording batch processes, a distinction is made between the plant and the batch.

The instrument can combine and record the data from up to 3 plants in batches (batch report). The number of batches for a plant is not limited. The instrument distinguishes between “current batch” and the most recently “completed batch” for a plant. The number of plants that are used and the texts in the batch template can be configured on the instrument or in the setup program.

4.9.1 Current Batches

This display shows the current data for the batch(es). Further information about entering the texts in the left and right columns can be found in.

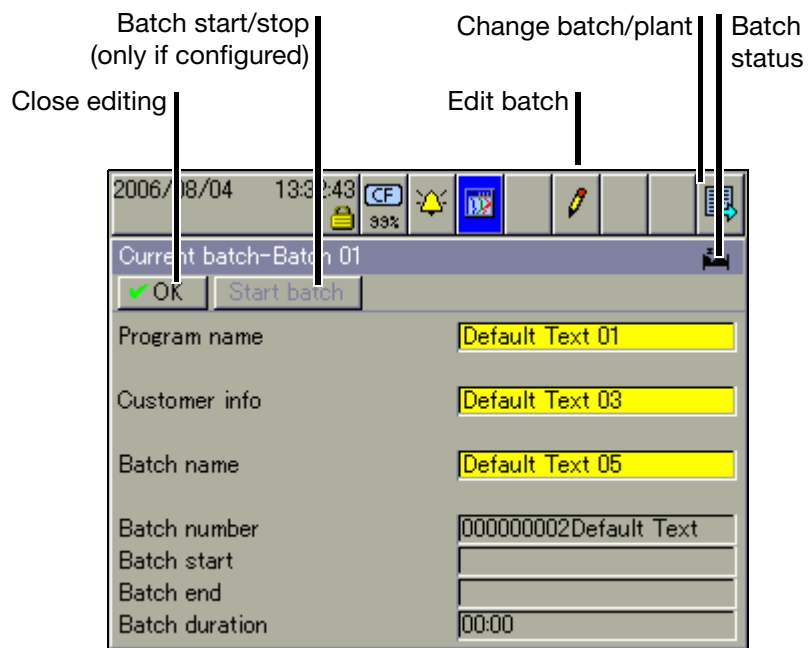

The batch texts on the right-hand side can be entered with one of the following options:

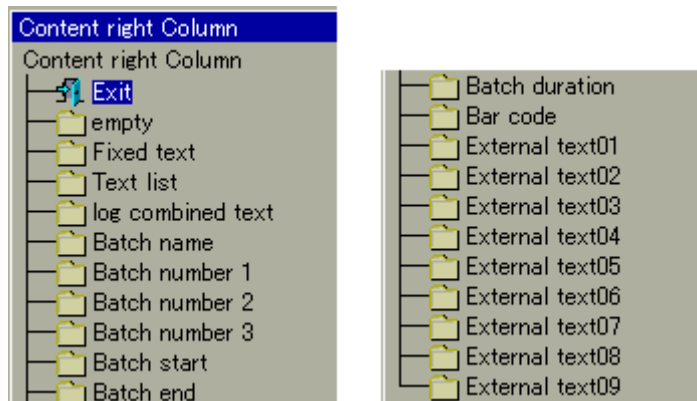

Edit batch

This function can be used to edit the batch text fields that are available (configured for this purpose). When the function has been called up, the first editable field in the screen template will be activated.



- * Press the control knob to start editing.
- * Enter the text (Chapter 9 "Entering text and values").



- * Rotate the control knob to select a new field or button, and activate it by pressing the control knob.

Change batch/ plant

Switching between the individual batches/plants. Max. 3 plants can be configured.

Start/stop batch

Use the parameter *Device manager* → *Configuration* → *Batches/plants* → *Plant X* → *General* → *Batch start* to configure how a batch starts and stops. The following are available:

- Start/stop by a binary signal (control signal)
- Start/stop by a barcode reader, and
- Manual start/stop by control knob.



At least 5 seconds must elapse between the stop of a batch (batch end) and the next start (batch start). A new batch cannot be started until this time has elapsed.

Batch status



The batch report that is displayed is active.



The batch report that is displayed is **not** active.

4 Visualization

4.9.2 Completed Batches

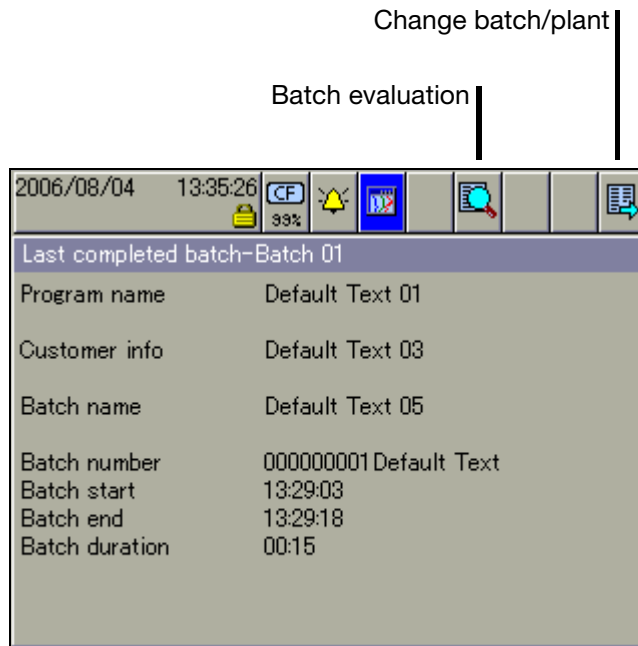

Batch evaluation

Completed batches can be evaluated in three different ways:

- Curves (graphical presentation)
- Report (numerical presentation)
- Attachments (e.g. recipes)

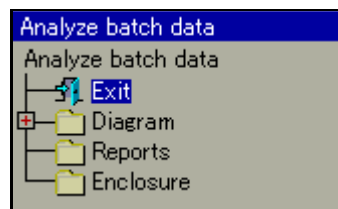

- * Rotate the control knob to select a type of presentation, then press the knob to activate this type.



Activating the door symbol in the header closes the selected presentation, and the batch data will be displayed again.

Change batch/plant

The corresponding batch data will be shown in its own batch visualization, depending on how many plants have been configured.

4.9.3 Batch Control with Barcode Reader

If a barcode reader is connected to the interface “RS232 for barcode reader” (connector 2) or “RS232/RS485” (connector 7), then the batch start, batch stop, and input of batch texts in a current batch report, can be controlled by the barcode reader. The bar codes that are used all correspond to the type “Code39”.

Preconditions

- The interface must be configured for bar code operation.
Example:
Configuration → Interface → RS232 for barcode reader → General → Protocol = bar code.
- The batch start (= batch stop) must be configured.
Example for batch start/stop:
Configuration → Batch/plant → Batch (Plant) 1 → General → Batch start = bar code.
- Every line that is to be set by the bar code must be configured.
Example for plant 1, line 1 (program name):
Configuration → Batch/plant → Batch (Plant) 1 → Line 1 → Content of right column = bar code.

Activate batch



Before entering commands through a barcode reader, the corresponding batch/plant 1 — 3 must be prepared by scanning in “BATCH1 — 3” for the bar code commands, regardless of whether or not they are automatically displayed.

Show batch report

If one of the visualizations is active, and nothing is being entered or edited at the moment, then the current batch report can be inserted via the barcode reader. The precondition is that the batch is active and the parameter is set to *Configuration → Screen → Bar code -> current batch = Yes.*

Activate and display (if required) batch report for batch (plant) 1:



BATCH1

Activate and display (if required) batch report for batch (plant) 2:



BATCH2

4 Visualization

Activate and display (if required) batch report for batch (plant) 3:



Start and stop batch report

If the batch report is configured for start/stop via barcode reader, then it will be started and stopped as follows.

Start batch:

- * Scan bar code for “Batch report for batch (plant) 1 — 3”.
- * Scan start.



Stop batch:

- * Scan bar code for “Batch report for batch (plant) 1 — 3”.
- * Scan stop.



If a batch report is stopped, then texts that have been activated by a bar code will be reset to the standard text in the currently active batch report depending on the parameter "Delete line". In the completed batch report, the texts will be saved.

Activate batch texts

If a line in a batch report is configured for barcode activation, the activation proceeds as follows.

Activate text:

* Scan bar code for "Batch report for batch (plant) 1 – 3".

Scan text.



The first line of the activated batch report that has been configured for text input via bar code will automatically be filled with the text that corresponds to the bar code. If several line have been configured for barcode activation, then they will be processed one after another, from top to bottom.

Reset entry

Execution of the following bar code will reset the activation of the batch texts. The standard texts (parameter *Factory setting*) will be displayed, and the first line will be prepared for input.



Summary of the bar codes

All the bar codes that are required are also collected together in Chapter 11.1 "Bar code".



The codes for batch control (BATCH1, BATCH2, BATCH3, START, STOP, RESET) cannot be used for setting batch texts.

4 Visualization

4.10 Counters and Integrators

In this presentation, the current states of the counters and integrators (totalizers) are displayed, as well as the operating hours counter. Up to 9 counters and integrators can be shown in one screen template. The functional characteristics (counter, integrator or operating hours counter) are defined in the device configuration.

Overview presentation

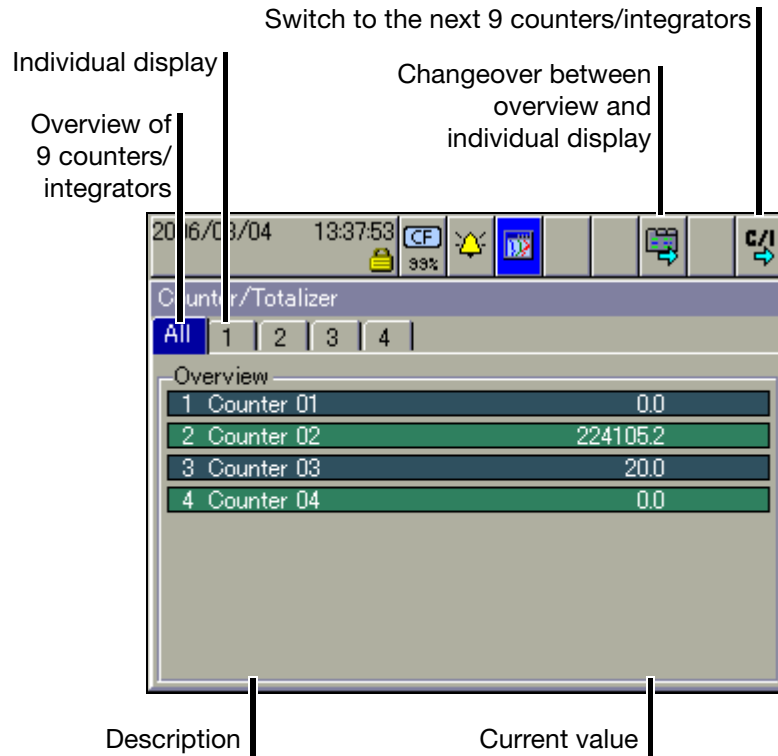

Individual presentation

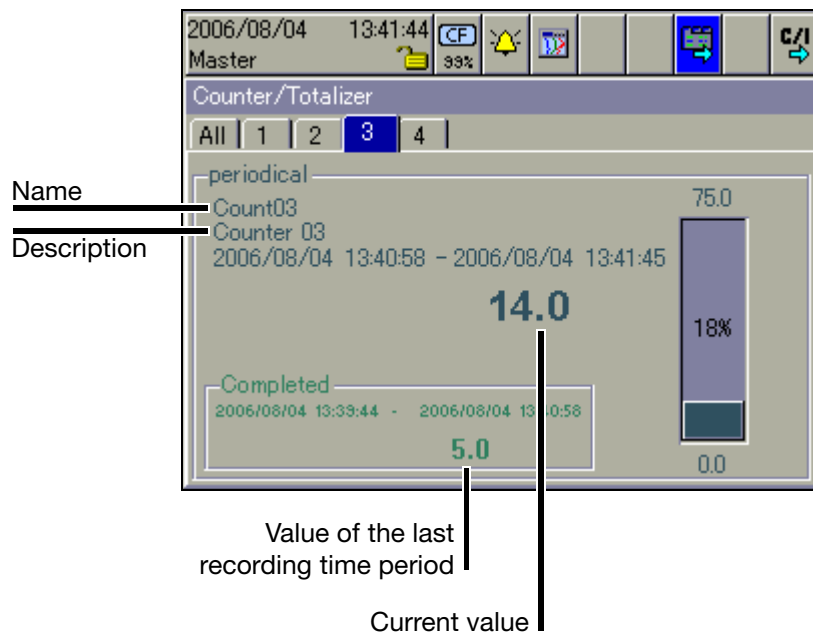

4.11 Comment Entry

This function can be used to enter a text (max. length 31 characters) that is entered in the event list when the input is completed.

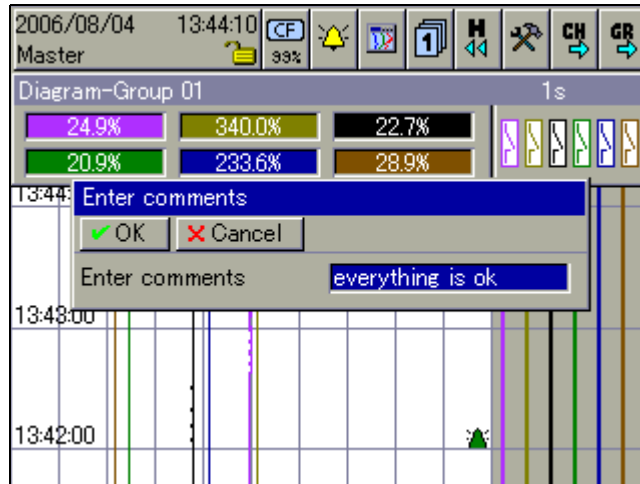

In curve presentation (in the displayed group), the text entry is marked by a pencil symbol.



- ⇒ Chapter 6 "Alarm and Event Lists"
- ⇒ Chapter 4.3 "Curve Presentation"
- ⇒ Chapter 4.11 "Comment Entry"

The text can now be found in the event list, under the heading "All events", but also under the corresponding batch.



If batches are used (parameter: *Device manager* → *Configuration* → *Batches/plants* → *Gen. plant parameters* → *Number of plants* is larger than 0), then the groups have a fixed assignment to the batches.

Plant number	Group	Plant (batch)
0	1 ... 9	None
1	1 ... 9	1
2	1 ... 3 4 ... 6 7 ... 9	1 2 Not assigned
3	1 ... 3 4 ... 6 7 ... 9	1 2 3

4 Visualization

5 Memory Presentation (History)

The Memory presentation function can be used to display and check data from the internal main memory (SRAM) of the instrument. The size of the memory for memory presentation can be configured.

The memory presentation can be activated in the visualization modes “Curve presentation” and “Binary presentation”, and is also used to display completed batches.

For this type of display one distinguishes between vertical and horizontal presentation. Only one of the two presentation types can be active for all groups.

⇒ *Configuration* → *Screen* → *Diagram display*



The memory presentation can only be called up if the parameter *Configuration* → *Groups* → *Group x* → *Parameters* → *Status* is set to “Display, save” in the configuration for the group.

Activate memory presentation (History)



- * In “Curve presentation” or “Binary presentation”, rotate and press the “H” symbol to select and activate the History presentation.



5 Memory Presentation (History)

5.1 Vertical presentation

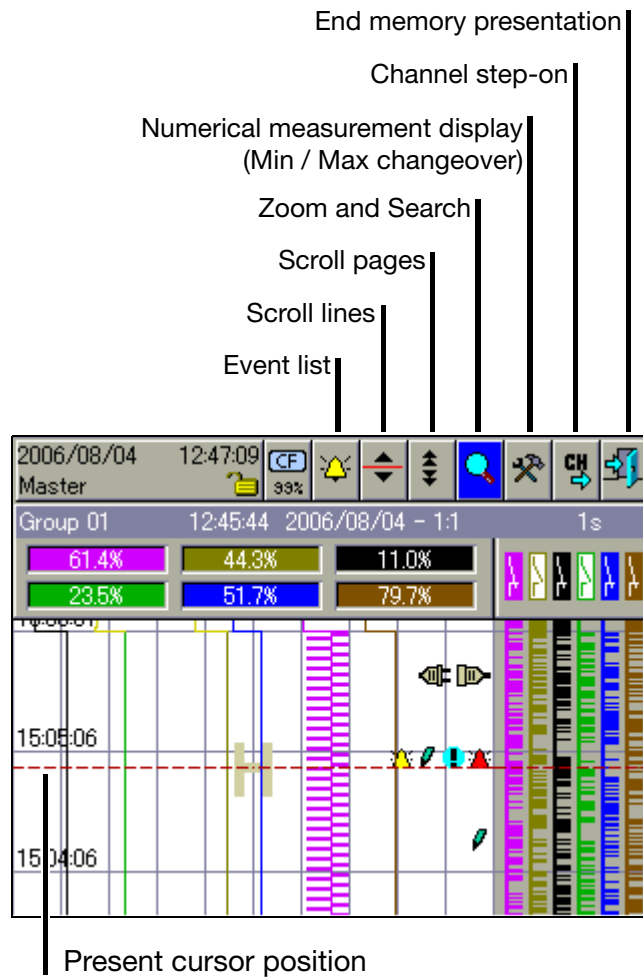

A cursor is now shown in the center of the visualization window. The corresponding measurements are shown in the line for “Numerical measurement display”. The status and title bar shows the time corresponding to the present cursor position, storage cycle that was used, and the scaling for the presentation.

Event list This function is used to present the event list for the group that is visible. The message that is closest to the cursor is shown in the list.

⇒ Chapter 6 "Alarm and Event Lists"

Scroll lines Rotating the control knob moves the cursor through the visualization window. The data in the “Numerical measurement display” are updated every time there is a shift. If you move right up to the edge of the window, the measurement curve will automatically be shifted and the required data will be presented.

“Scroll lines” can be ended by pressing the control knob.

Scroll pages Rotating the control knob moves the cursor an entire screen (=page) at a time. The data in the “Numerical measurement display” are updated every time there is a shift. The system automatically positions the cursor at the end of the

5 Memory Presentation (History)

page, as required.

“Scroll pages” can be ended by pressing the control knob.

Zoom and search

This function affects how many measurements are used to calculate a point in the diagram, and to search for measurements according to date and time.

Zoom

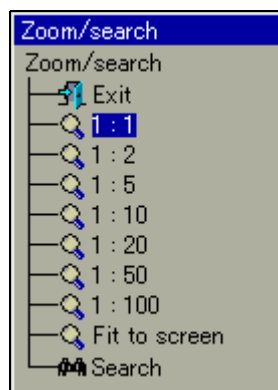

The factory setting is “1:1”, which means that every measurement in the History memory will be displayed. “1:2” means that every second measurements is displayed, and so on.

- * Select the zoom factor by rotating the control knob.
- * Close the dialog window and activate the new zoom factor by pressing the control knob.
- * Selecting “Exit” closes the dialog window, and the presentation remains unchanged.

Fit to screen

This function is only available for presenting the data for a completed batch. If this function is selected, the zoom factor will automatically be adjusted so that the measurement curve for the completed batch is shown in one window. However, 1:1 presentation should be used for evaluating a batch.

Search

If you select “Search”, the dialog window for entering the date will be shown.

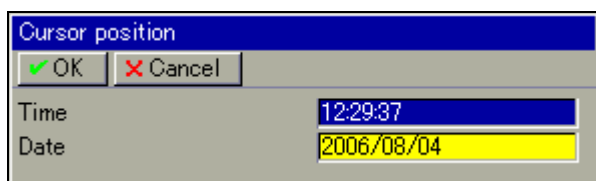

- * Select the date and time, and use OK to close the dialog.

If the date that was entered is in the History memory, the cursor will move to this position and the data will be shown.

5 Memory Presentation (History)

Numerical measurement display

This function decides whether the MAX or MIN values are shown in the “Numerical measurement display”. Min or Max values arise when more measurements are recorded than are displayed. This will be the case if “Min/Max recording” is activated in a group operating mode.

Channel step-on

This function activates the scaling display. Repeatedly activating the function steps through the scaling for the channels within the group, and then blanks it out again.

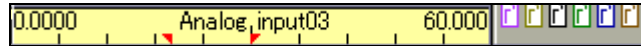

Close memory presentation

This function starts the presentation of the data that are available in the internal main memory of the instrument.

5.2 Horizontal presentation

In the display the individual signals run across the screen from right to left (horizontal presentation).

The same functions as for the vertical presentation apply.

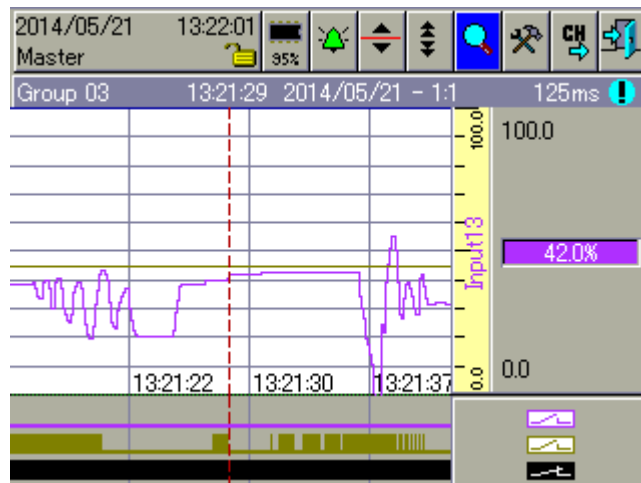

6 Alarm and Event Lists

The alarm and event lists can be called up in two ways:

- A call from one of the visualization modes, e.g. curve presentation (diagram)
(Chapter 4.2 "Overview of Header Lines")

and

- A call from the memory presentation
(Chapter 5 "Memory Presentation (History)").

Alarm lists

Alarm lists contain only the alarms and errors that are currently present.



The alarm list will not be updated as long as the window is open.
Remedy: Close once, and open again. This will update the alarms.

Event lists

Events list contain all the events that have occurred, including all alarms and errors.



A maximum of 150 entries can be fitted into the two lists. The lists will be deleted if a reconfiguration takes place.



The following description assumes that three batches are being used. The number of batches may vary, because it can be configured by the user.

6 Alarm and Event Lists

6.1 Call from One of the Visualization Modes

- * In the header line, rotate and press the control knob to select and activate the bell symbol.



- * Select the required list.

Activate alarm list

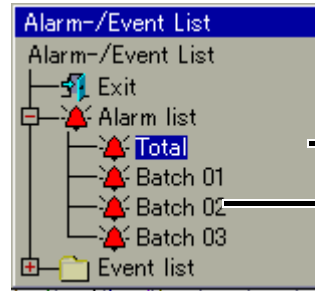

Complete list of alarms

Batch-related alarm lists if the number of batches is reduced, then fewer entries will be displayed.

- * Rotate the control knob to select a list, then press the knob to activate the list.

Activate event list

First, the directory tree for the event lists must be “unfolded”.

- * Rotate the control knob to select an event list, then press the knob to activate the list.

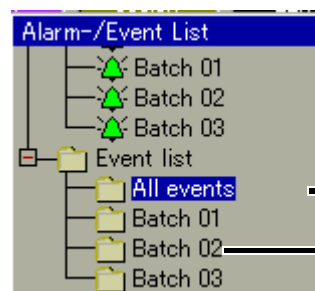
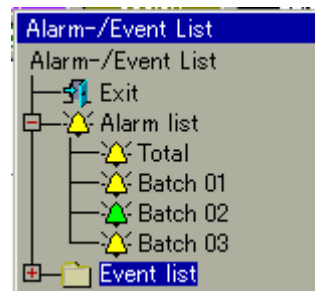

Complete list of events

Batch-related event lists

6 Alarm and Event Lists

- * Rotate the control knob to select a list, then press the knob to activate the list.

Example

In the example, you can see a complete event list.

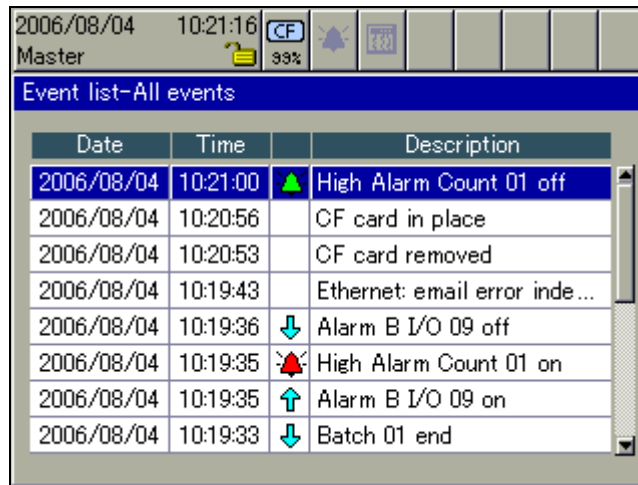

Date	Time		Description
2006/08/04	10:21:00	▲	High Alarm Count 01 off
2006/08/04	10:20:56		CF card in place
2006/08/04	10:20:53		CF card removed
2006/08/04	10:19:43		Ethernet: email error inde...
2006/08/04	10:19:36	▼	Alarm B I/O 09 off
2006/08/04	10:19:35	▲	High Alarm Count 01 on
2006/08/04	10:19:35	▲	Alarm B I/O 09 on
2006/08/04	10:19:33	▼	Batch 01 end

Close list

- * Close the event list by pressing the control knob.

The visualization that was active before the list was called up will now be displayed again.

6 Alarm and Event Lists

6.2 Call from the Memory Presentation



- * In the header line, rotate and press the the control knob to select and activate the bell symbol.



Only the event list for the active group will be shown in the memory presentation. The message that is closest to the cursor is shown in the list.

Close list

- * Close the event list by pressing the control knob.

The memory presentation that was active before the list was called up will now be displayed again.

6.3 Symbols

	Power on (instrument has been switched on)
	Power off (instrument has been switched off)
	Error
	Alarm disappears (alarm is no longer present)
	Alarm occurs (an alarm is present)
	Comment
	Event occurs (e.g. binary input has been closed)
	Event disappears (e.g. binary input has been opened)
(no symbol)	Other messages

7 Memory Manager

The memory manager contains functions for data exchange between the paperless recorder and CF memory cards or USB memory sticks.



Symbols

The symbol for the Memory manager (menu: Memory manager) in the header can be shown in different ways.



This shows the available memory of the CompactFlash memory card that has been inserted.



Shows the available memory of the USB memory stick.

If no CF card or no USB memory card has been inserted, then one of the following symbols will be shown, depending on the type of data read-out that was configured.



This shows the available internal memory for reading out data via the CompactFlash memory card.



This shows the available internal memory for reading out data via the interface.

Activation for CF cards



Access to the memory manager menu via the header is only possible if a CF card is inserted in the device.

If one of the visualization modes, (see Chapter 4 - e.g. Curve Presentation), is active when a CF card is inserted in the instrument, then the menu appears automatically.

If not all functions are available, then you must log in to the device first, in order to obtain the required access rights.

⇒ Chapter 8.2 "Log-in and Log-out"



The CF card must not be removed while a data transfer to or from the card is in progress.



If this symbol appears in the status and title bar, do **not** remove the CF card!

7 Memory Manager

Activation for USB stick



Access to the Memory manager menu via the header is **not** possible with a USB memory stick.

If one of the visualization modes (Chapter 4 - e.g. Curve Presentation) is active when a USB memory stick is inserted, the menu automatically appears and remains active until the memory stick is removed again.

If not all functions are available, then you must log in to the device first, in order to obtain the required access rights.

⇒ Chapter 8.2 "Log-in and Log-out"



The USB memory card must not be removed while a data transfer to or from the stick is in progress.

Start via menu

- * Activate the memory manager by rotating and pressing the control knob (CF card must be inserted).

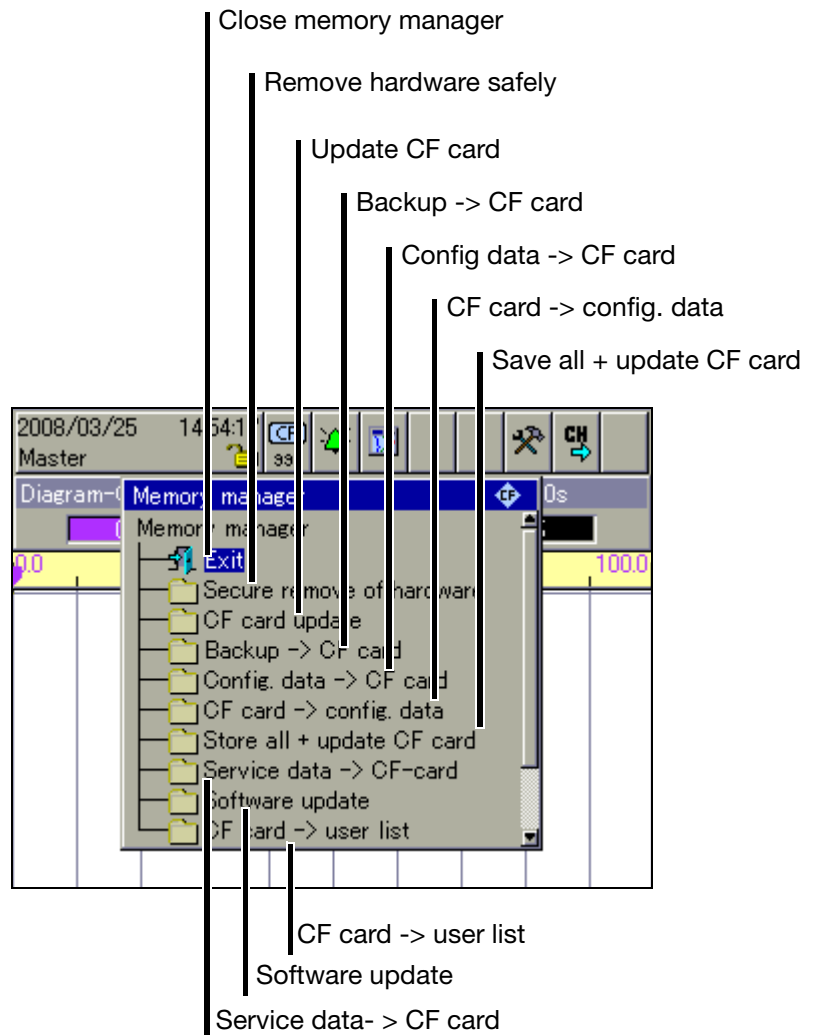

7 Memory Manager



The functions of the memory manager are the same for CF cards and USB memory sticks. For USB sticks, the menu entries have "USB stick" instead of "CF card".

Close memory manager (Exit)

Close the memory manager and reactivate the previous visualization.

Safely removing hardware

The function should always be called before removing a CF card or a USB stick. This is the only way to ensure that files are properly stored on the data storage medium.

When the message "Hardware can be removed now" appears, the data storage medium can be removed.

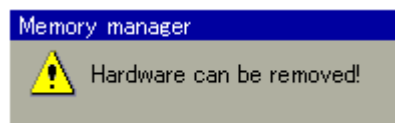

Update CF card

Measurement data not yet saved to a CF card (a USB stick) are written to the data storage medium.

Backup -> CF card

All measurement data in the memory (also those which have already been fetched) are written to the data storage medium.

Config data -> CF card

The configuration data and the user list (for password management) are written to the data storage medium.

CF card -> config. data

Configuration data are read into the device from the data storage medium.



This will give the recorder a new configuration.

Subsequently, the data recording will be started again.

Save all + update CF card

All current reports will be concluded and written to the data storage medium, together with the measurement data that have not yet been saved. The present counter and integrator states will also be saved.

Service data -> CF card

Special data are saved to the CF card. The function may only be carried out if the user has been asked to do so by a service engineer from the instrument manufacturer.

Software update

This function serves for reading in a new device software (firmware). To do this, a special CF card is required. Only a service engineer from the instrument manufacturer may perform the update.

CF card -> user list

The user list is read in from the data storage medium and activated in the paperless recorder.

7 Memory Manager

General information



The function *CF card update* reads out data that have not yet been read out. After read-out, data are not marked as read in the recorder but are not deleted.

Function *Backup → CF card* reads all data from internal memory, including what had already been read. After read-out, the data are marked as read in the recorder. The function *Backup → CF card* is therefore ideal for test and service work.



Only one data storage medium can ever be inserted at a time, either a CF memory card or a USB memory stick. Paperless recorders without extra code Stainless steel are equipped with two USB host interfaces (one on the front and one on the back). In this case also, only one can be used at a time, **never** both together.

8 Device Manager

The functions of the Device manager vary, depending on whether a user is logged in or not.

**No user
logged in**

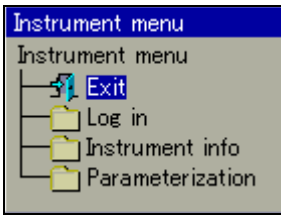
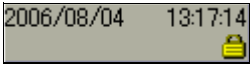

**“User”
logged in**

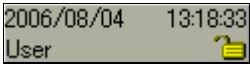

**User
“Master”
logged in**

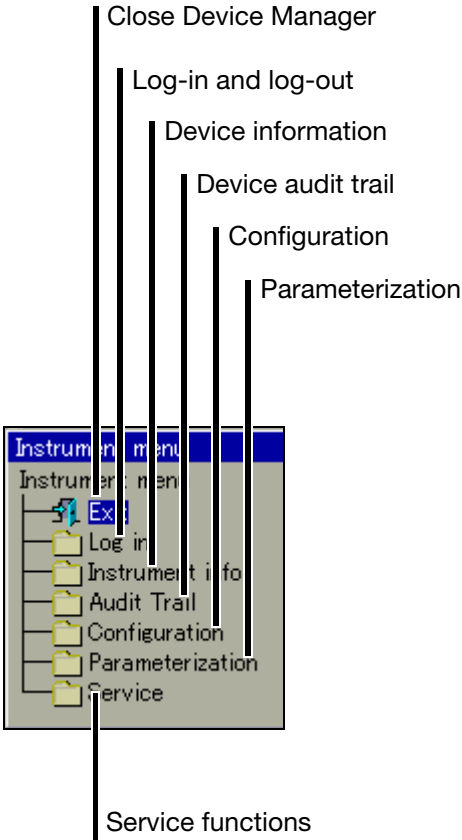
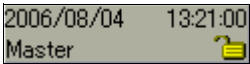

The differences between “No user logged in” and “User logged in” only become visible in the submenu “Parameterization”.

8 Device Manager

8.1 Close Device Manager

Close the device manager and reactivate the previous visualization.

8.2 Log-in and Log-out

- * Select the *Device manager* in the header, by rotating the control knob.
- * Activate the *Device manager* by pressing the control knob.
- * In the *Device manager* activate the function *Log in*.

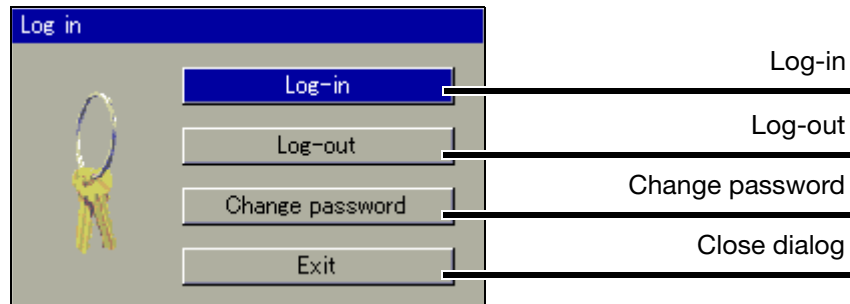

Default users



The paperless recorder is delivered ex-factory with an internal user list which contains two users.

1. User: Master password: 9200
2. User: User password: 0

The setup program can be used to alter the two user names and their passwords and access rights, and transfer this information to the device.

Log-in

- * In the menu *Device manager* → *Log-in*, activate the function *Log-in*.

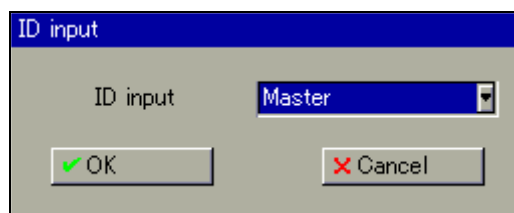

- * Select the user. The user name can be changed by rotating the control knob.

8 Device Manager

- * Select "OK" with the control knob, and press the control knob.



- * Enter the password by rotating and pressing the control knob, and finish the entry with "OK".

You are now logged in to the system.

2006/08/04 11:41:43
Master 

8 Device Manager

8.3 Device information

This function provides you with information on the hardware and software components of the instrument. The momentary values of all the internal and external inputs can also be checked.

The control knob can be rotated to display every single table. The function is terminated by pressing the control knob.

Version

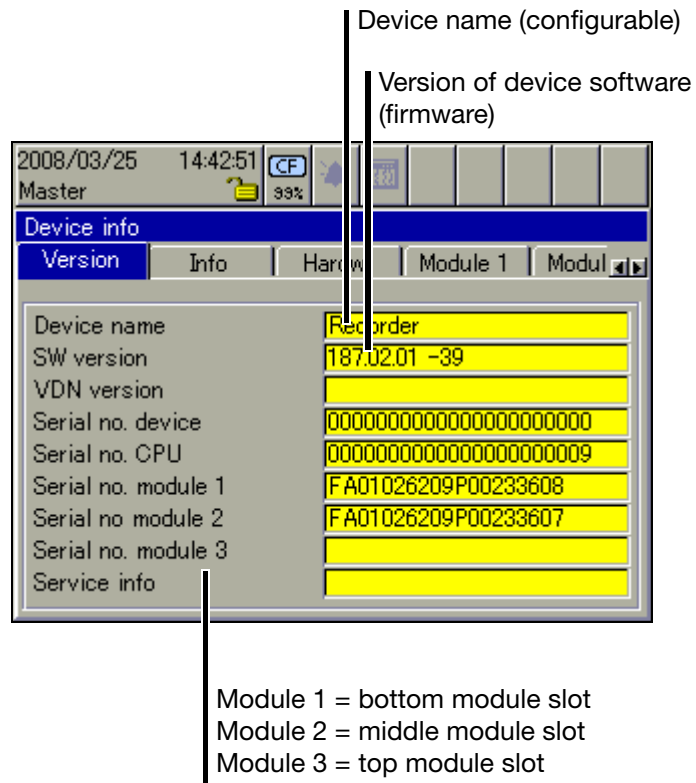

The screenshot shows the 'Device info' screen with the 'Version' tab selected. The screen displays the following information:

Field	Value
Device name	Recorder
SW version	187.02.01 -39
VDN version	
Serial no. device	00000000000000000000
Serial no. CPU	00000000000000000009
Serial no. module 1	FA01026209P00233608
Serial no. module 2	FA01026209P00233607
Serial no. module 3	
Service info	

Annotations:

- Device name (configurable)
- Version of device software (firmware)
- Module 1 = bottom module slot
- Module 2 = middle module slot
- Module 3 = top module slot

8 Device Manager

Info

Module 1 = bottom module slot
Module 2 = middle module slot
Module 3 = top module slot

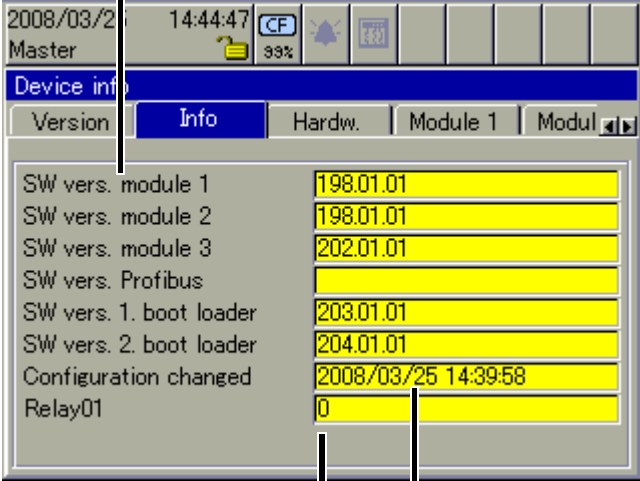

Date and time of last reconfiguration

Switching state of relay 1 (fitted as standard);
0= not switched

Hardware

Bottom module slot
Middle module slot
Top module slot

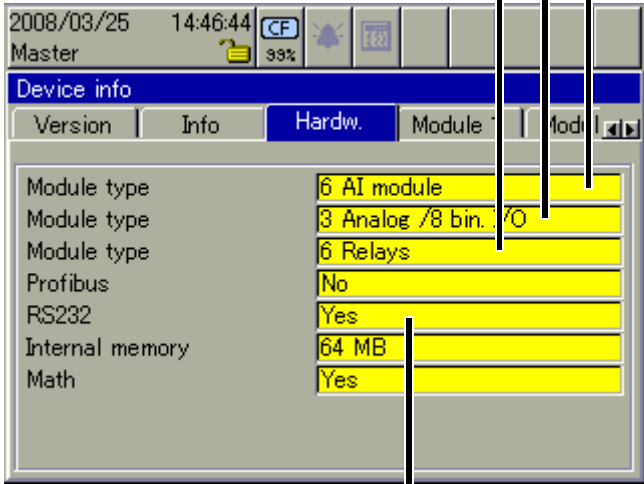

RS232 for barcode reader

8 Device Manager

Module 1

The picture below shows a module that has been fitted with 6 analog inputs. Depending on the hardware level, the picture may look different. Module 1 is in the bottom module slot.

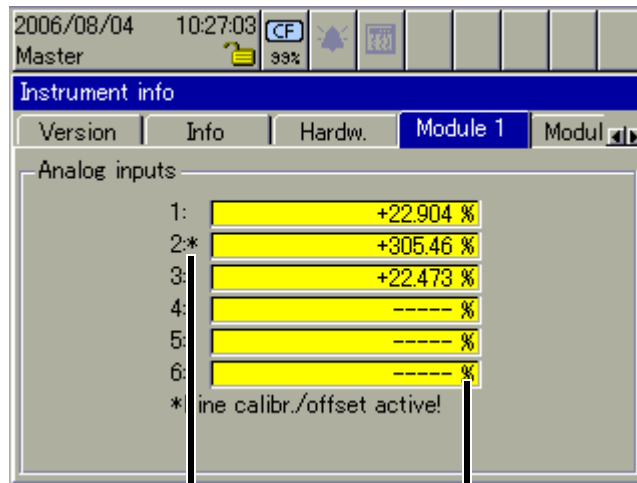

The * indicates that an offset or fine calibration is active on this channel.

Display of the current analog values from module

Module 2

The picture below shows a module that has been fitted with 3 analog inputs and 8 binary inputs/outputs. Depending on the hardware level, the picture may look different. Module 2 is in the middle slot.

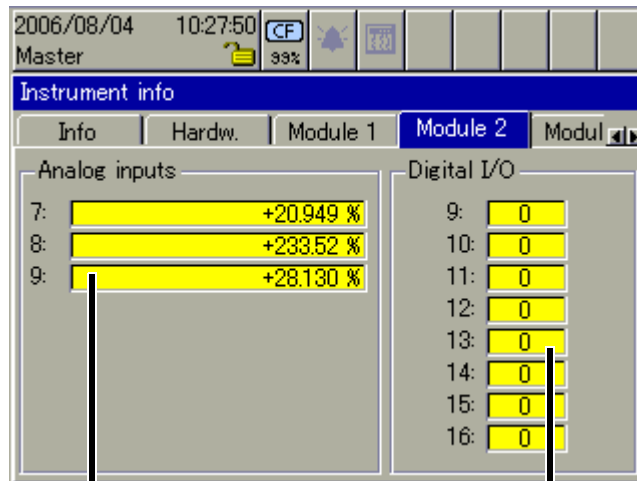

Display of the current analog values from module

States of the binary inputs/ outputs (0 = not active).

Module 3

The picture below shows a module that has been fitted with a relay card (6 relays). Depending on the hardware level, the picture may look different. Module 3 is in the top slot.

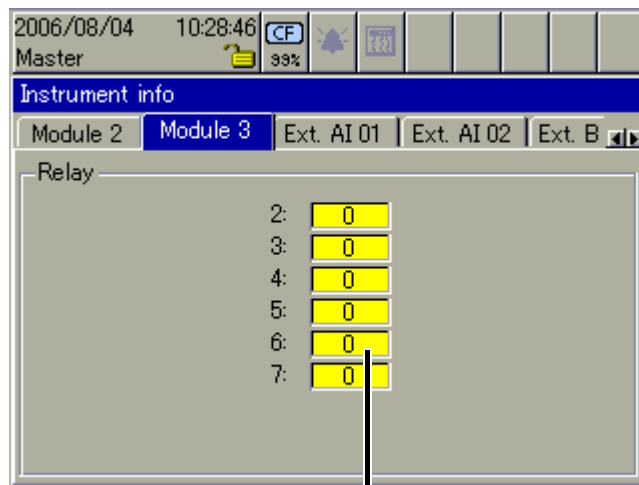

Switching state of relays
(0 = not switched).

Ext. analog input (AE) 1 – 2

The two windows show the current external analog inputs. External analog inputs are read into the recorder via one of the interfaces (e.g. through the Modbus Master function).

Ext. binary input (BE)

The window shows the current external binary inputs. External binary inputs are read into the recorder via one of the interfaces (e.g. through the Modbus Master function). Unlike the internal binary inputs/outputs, external binary outputs are not available.

Ext. texts

The three windows display the current external texts that can be integrated as inscription or informational text in the batch protocols. External texts are read into the recorder via one of the interfaces (e.g. through the Modbus Master function).

8 Device Manager

Eth. info 1

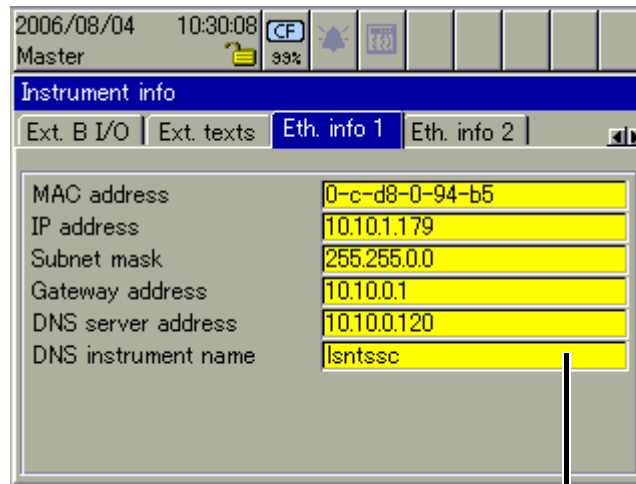

Information about the current Ethernet configuration

Eth. info 2

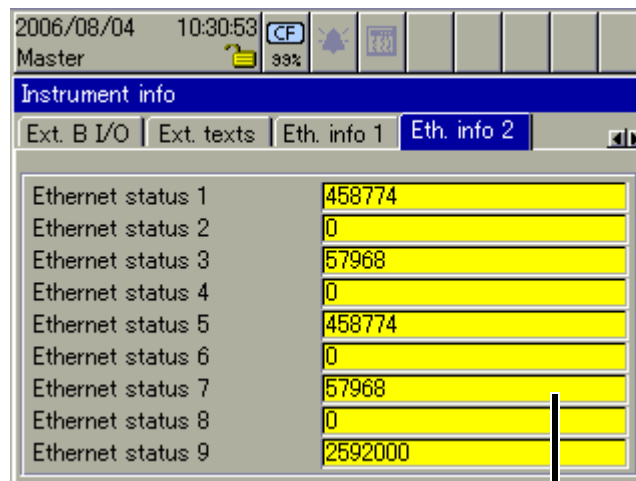

Information about the current Ethernet communication

Parameter	Description
Ethernet status 1	Received Ethernet packets
Ethernet status 2	Received Ethernet packets with errors
Ethernet status 3	Transmitted Ethernet packets
Ethernet status 4	Transmitted Ethernet packets with errors

Parameter	Description
Ethernet status 5	Received TCP packets
Ethernet status 6	Received TCP packets with errors
Ethernet status 7	Transmitted TCP packets
Ethernet status 8	Transmitted TCP packets with errors
Ethernet status 9	Received Lease time, in seconds

USB info

Information appears in the window via the USB interfaces. This information is only of interest for servicing.

Interface

Information about the serial interfaces and PROFIBUS DP interface appears in the window. The user can see the set interface parameters without having to go to the configuration. Parameters are also visible if there are no users logged in on the instrument.

8.4 Device Audit Trail

The audit trail contains a log of all user actions on the recorder.

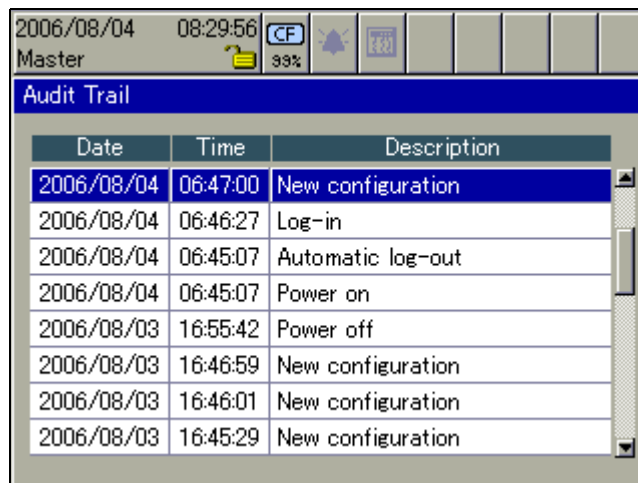

The screenshot shows a software window titled "Audit Trail". At the top, it displays the date "2006/08/04", time "08:29:56", and the user "Master". Below this is a table with three columns: "Date", "Time", and "Description". The table contains the following entries:

Date	Time	Description
2006/08/04	06:47:00	New configuration
2006/08/04	06:46:27	Log-in
2006/08/04	06:45:07	Automatic log-out
2006/08/04	06:45:07	Power on
2006/08/03	16:55:42	Power off
2006/08/03	16:46:59	New configuration
2006/08/03	16:46:01	New configuration
2006/08/03	16:45:29	New configuration

The function is terminated by pressing the control knob.

8 Device Manager

8.5 Configuration

This function can be used to alter the configuration of the recorder.

⇒ B 706581.0.



An alteration of the configuration results in the current recording being closed down and the new data being recorded in a separate time frame from the “old” data. It is not possible to present the data before reconfiguration and the data after reconfiguration as a single entity. The instrument works with a new configuration.

8.6 Parameterization

For parameterization, some functions will not be available if no user is logged in, or the user who is logged in does not have the access rights for these functions.

Only the setting of individual current batch numbers is enabled in the factory (default) setting.

⇒ B 706581.0.

8.7 Service

The “Service” functions will also not be available if no user is logged in, or the user who is logged in does not possess access rights for these functions.

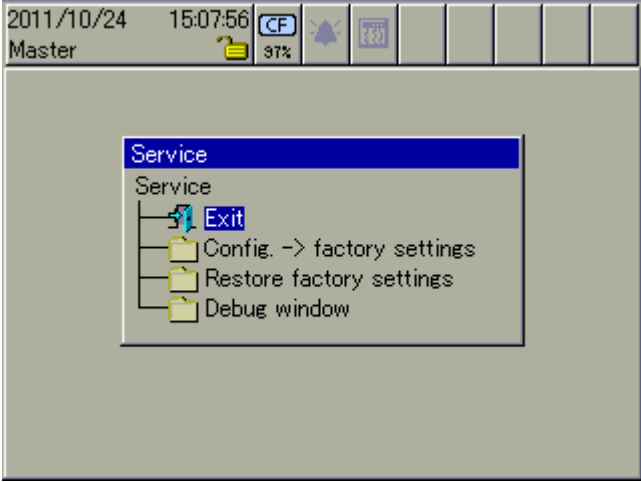

- Config. -> factory settings** The current configuration can be saved within the device as the new factory setting.

- Restore factory settings** The factory setting, e.g. created by “Set->curr. settings as default”, is called up and the instrument is reset.

- Debug window** Only a service engineer from the instrument manufacturer may use this function.

8 Device Manager

9 Entering text and values

9.1 Text entry

9.1.1 Entering characters

If a Text entry field is selected, and then activated by pressing the control knob, then a text can be entered or altered.



The cursor (position marker) is at the end of the current setting. The active key or function that will be performed when the control knob is pressed is shown in blue.

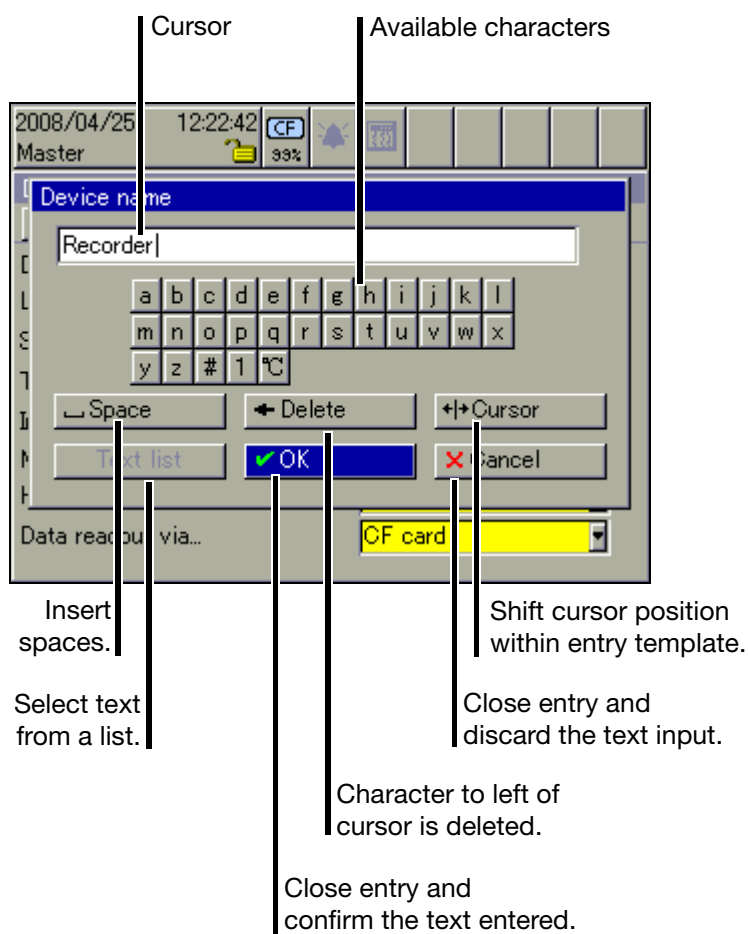

Available characters



The characters that are shown as available are just an example. They can be adjusted to suit your needs through the setup program.

9 Entering text and values

Character entry

- * Move the cursor onto the required character, and press the control knob. Another selection window will open.

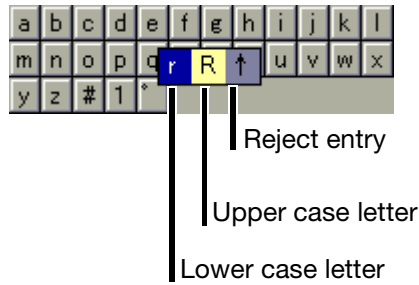

- * Rotate the control knob to select upper case (capital) or lower case (small) letters, or reject an entry, and activate/confirm the choice by pressing the control knob.

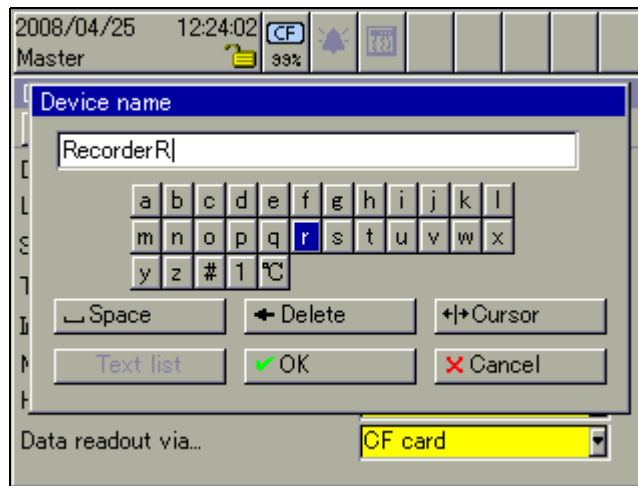

Entering special characters

Special characters are entered as text.

- * Select the # symbol and press the control knob.

All the special characters that can be selected will now be shown.

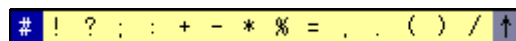

Here too the selection and confirmation of the characters are made by rotating and pressing the control knob.

Number entry

- * Select number "1", and press the control knob.

All the numbers that can be selected will now be shown.

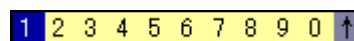

The selection and confirmation of the numbers are made by rotating and pressing the control knob.

9 Entering text and values

Select temperature unit

- * Select “ ” and press the control knob.

All the temperature units that can be selected will now be shown. For better legibility, the degree sign (°) and the unit of measure (C or F) are separated, and must be individually selected.

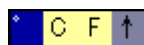

The selection and confirmation of the symbol is made by rotating and pressing the control knob.

9.1.2 Insert spaces

- * Select the space button () and press the control knob.

The space character will be inserted to the right of the cursor.

9.1.3 Delete character

- * Select the delete button () and press the control knob.

The character to the left of the cursor will be deleted.

9.1.4 Move cursor

- * Select the cursor positioning button () and press the control knob.

The cursor can now be moved. To end shifting, press the control knob again.

9.1.5 Enter text from text list

The last 20 texts that were entered (confirmed by OK) will be stored in the recorder, in an internal text list. This function can be used to call up the list and select a text for current application.

- * Call text list ().

The selection and confirmation of the required text are made by rotating and pressing the control knob.

9.1.6 Finish entry

- * Select the “OK” button () and press the control knob.

Character entry will now be ended. The text that was entered is accepted, and the dialog window is closed.

9 Entering text and values

9.1.7 Reject entry

- * Select the “Cancel” button () and press the control knob.

Character entry will now be ended. The text that was entered is **not** accepted, and the dialog window is closed. The previously active setting is retained.

9.2 Entry via selection field

If a selection field is selected, and then activated by pressing the control knob, then the text (value) can be entered from a previously defined list.



The cursor (position marker) is on the current setting.

- * Make the selection by rotating and pressing the control knob.

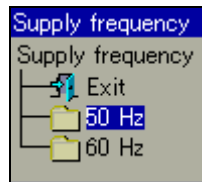

9.3 Entering values

9.3.1 Whole numbers (integers)

There are two possibilities for entering integer numbers:

- selection by altering the individual digits of a number, or
- selection by incrementing and decrementing.

Digit-by-digit entry of an integer

For this entry, each digit of the number (units, tens, ...) and the sign are selected with the control knob.

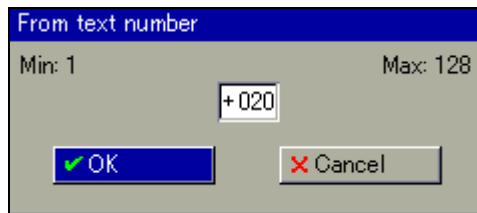

Example

- * Select "2" (the tens digit) by rotating the control knob ().
- * Press the control knob.

The tens digit is now shown in red, to indicate that this digit can now be altered (.

- * Rotate the control knob to alter the tens digits, and then confirm the entry by pressing the control knob.

The tens digit has now been altered, and is shown in blue again (.

Selection by incrementing and decrementing

For this entry, the complete number is reduced by 1 (decremented) or increased by 1 (incremented) with the control knob.

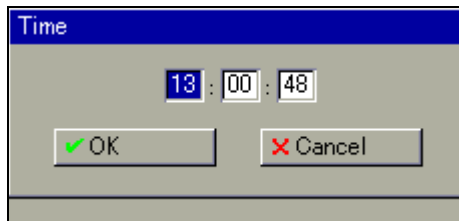

Example

- * Select the hour by rotating the control knob (.
- * Press the control knob.

The number is now shown in red, to indicate that it can now be altered (.

- * Rotate the control knob to alter the number, and then confirm the entry by pressing the control knob.

The number has now been altered, and is shown in blue again (.

9 Entering text and values

9.3.2 Real numbers (floating point)

To enter real numbers (with a decimal point), each digit of the number (units, tens, etc.), the decimal point position, and the sign are selected with the control knob.

Sequence

- Position the cursor.
- Enter the number or define the decimal point position.

For number entry, the number is inserted at the right of the cursor.

Cursor positioning

- * Select "Cursor" and press the control knob.

The real number is indicated by a blue background.

- * Rotate the control knob to move the cursor to the required position, and then press the control knob.



When a number is entered, it is inserted at the right of the cursor.
When deleting, the digit to the left of the cursor is deleted.

Character deletion

- * Position the cursor.
- * Select "Delete" and press the control knob.

The character to the left of the cursor will be deleted.

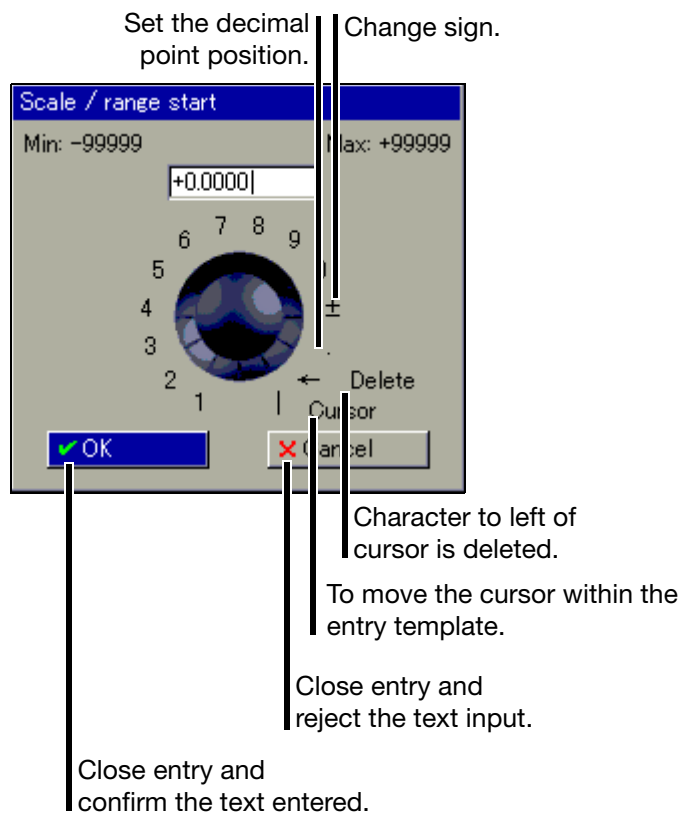

The web server functionality depends on the software version of the device.



Which device software version is installed?

⇒ Chapter 8.3 "Device information"

Up to 187.03.xx ⇒ Chapter 10.1 "General" to Chapter 10.5 "QuadView"

As of 187.04.xx ⇒ Chapter 10.6 "General information" to Chapter 10.9 "QuadView"



The web server only supports the vertical recorder image

10 Web server

10.1 General

The web server is integrated in the paperless recorder as a standard feature. Four different modes of presentation are available:

- "Online Visualization (All Visualizations Except Batches)"
- "Three freely programmable HTML pages"
- "Online Visualization of Current Batch Reports"
- "QuadView"

The web server can be accessed on the PC side with Microsoft® Internet Explorer by entering the IP address (e. g. http://10.10.90.45). DNS names can be assigned on the device. Therefore a device can also be accessed using the DNS names. For visualizing graphics, the SVG Viewer from Adobe® must be installed on the PC in addition to Internet Explorer.



Up to 4 PCs (clients) can have access to the device via the Ethernet interface.

Log-in

A password query has been activated in the factory. The user can switch it to inactive with the PC setup program.



If the option is active () the entry template will automatically be filled in the next time the web browser is restarted. The user only needs to confirm with OK.

Factory setting:
User = Master
Password = 9200



When entering the user name and password, distinctions of upper- and lower-case letters must be observed.

Home page

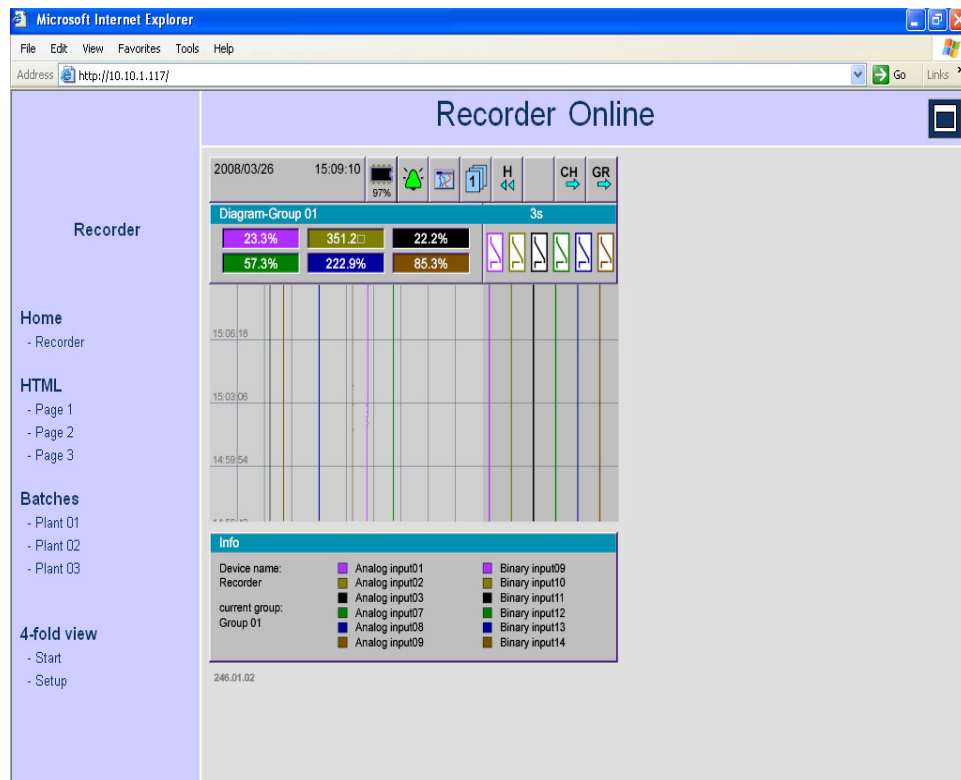

Online visualization automatically comes up as the home page if the web server is started by the browser or, if it has already been activated, the user (left) clicks the "Recorder" link.

Areas

The web server's display is divided into three areas:

- Header
- Navigation
- Visualization area

Header

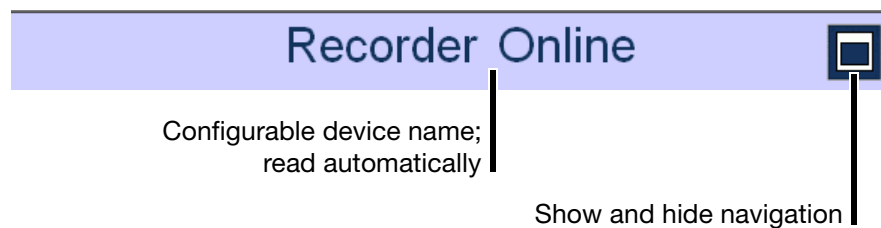

10 Web server

Navigation

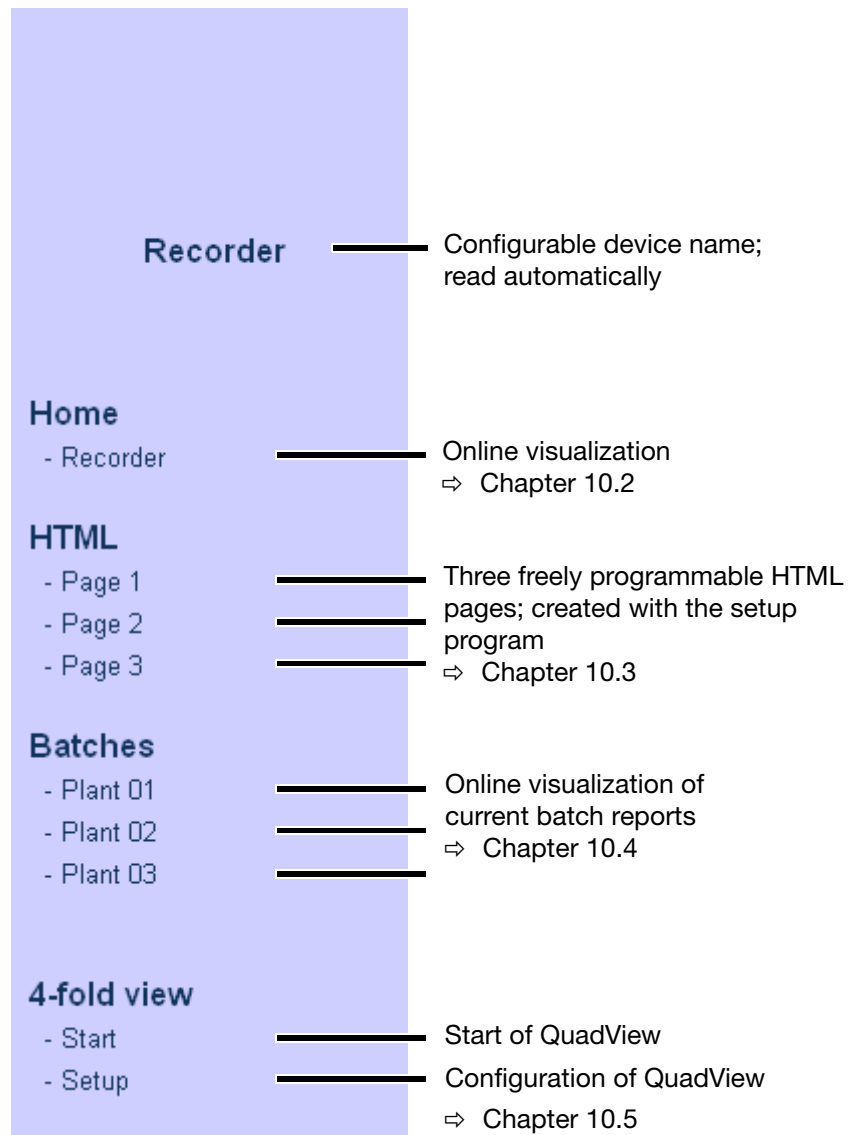

Individual pages can be brought up by clicking (left mouse button).

Visualization area

The visualization area shows current data for the paperless recorder. The most recent data are read from the device automatically every 3 seconds.

10.2 Online Visualization (All Visualizations Except Batches)

Data that are displayed correspond to the configured groups of the recorder.

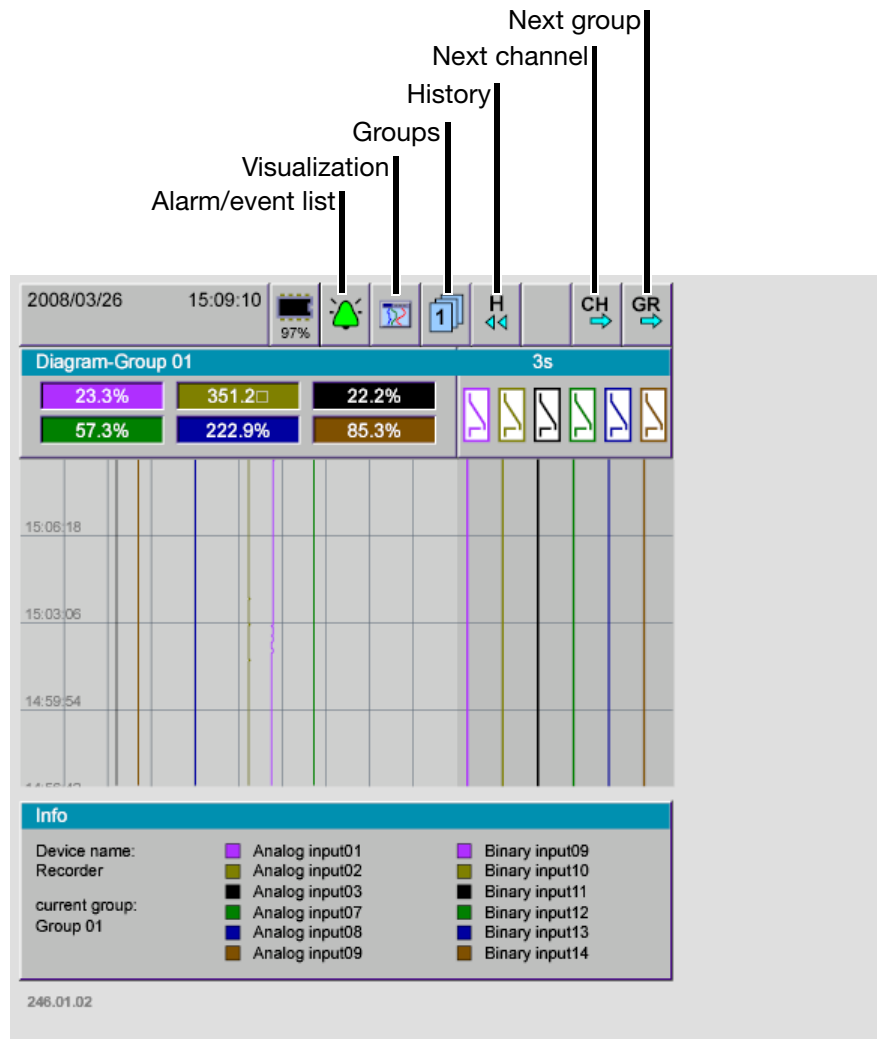

The sample screen shows the web server's home page. This page can be used to represent channels in the same manner as on the recorder's screen. (Left) click to bring up the available menus of the recorder.

10 Web server

Example

Switching to bar graph presentation

- * (Left) click the Visualization menu.

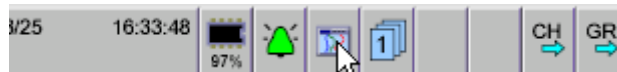

- * (Left) click the bar graph.

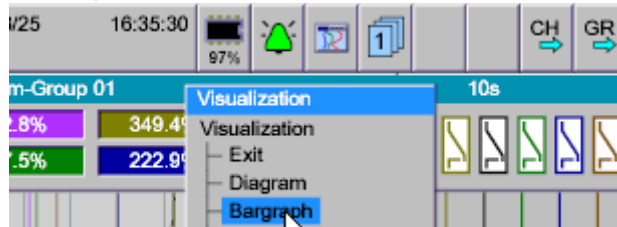

Result: The bar graph visualization type is activated.

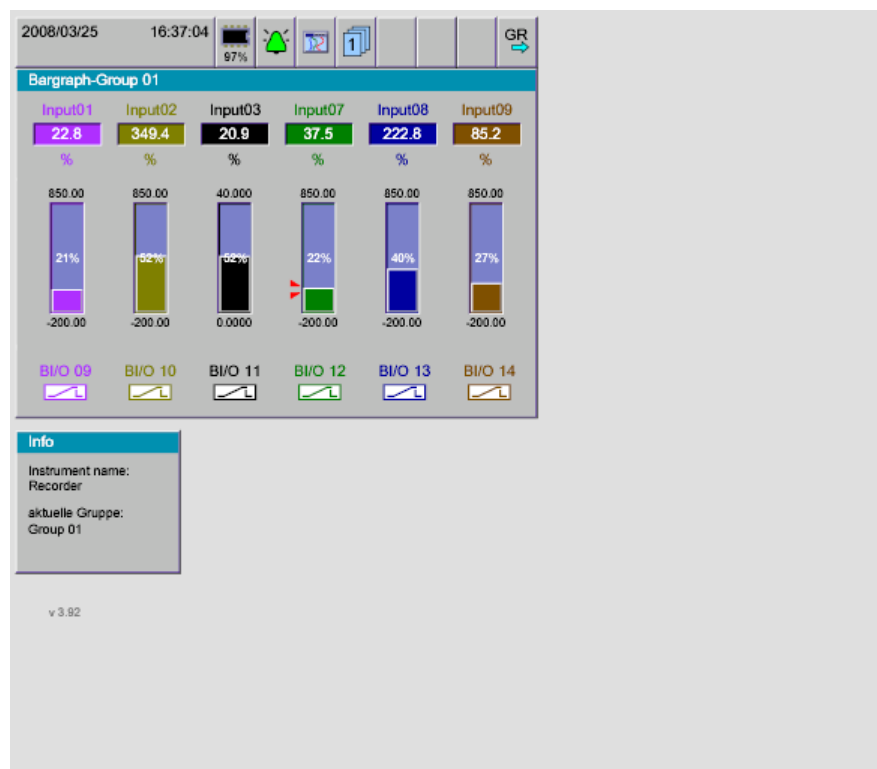

10.3 Three freely programmable HTML pages

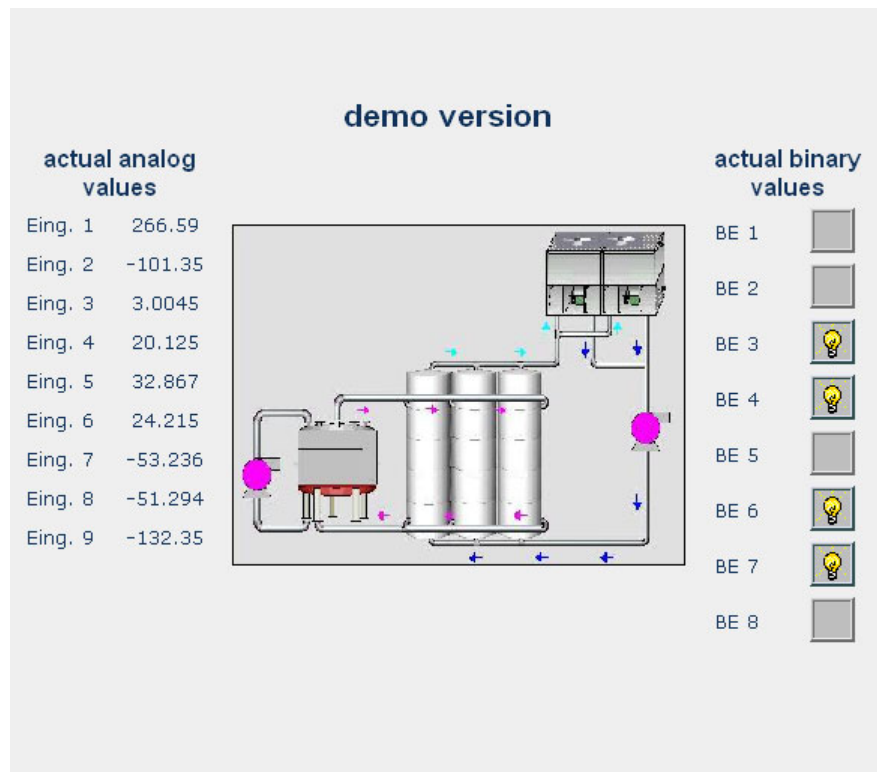

The sample screen shows one of three freely programmable HTML pages. These pages can be created and modified with the setup program.



Further information can be obtained from the instructions on the setup program (B 706581.6).

10 Web server

10.4 Online Visualization of Current Batch Reports

When batch pages of a plant are called up, the current data from the recorder is read and displayed.

The screenshot shows a web interface for 'Batch 01'. At the top, it says 'Batch recording is active' with a lightbulb icon and 'or inactive' with a grey square. Below this is 'Batch 01 active:' with a lightbulb icon. The main area contains a table of batch data:

Program name	Default Text 01
Customer info	Default Text 03
Batch name	Default Text 05
Batch number	900000006Default Text
Batch start	2008/03/25 16:12:56
Batch end	2008/03/25 16:13:05
Batch duration	00:09
Remarks	<div style="border: 1px solid black; height: 80px; width: 100%;"></div>

Annotations with lines pointing to specific elements:

- 'Batch recording is active or inactive' points to the lightbulb icon and the grey square.
- 'Editable text field; (left) click and enter text' points to the 'Batch 01 active:' label.
- 'The "Appendix" can be viewed in visualization "Completed batch" using function "Batch evaluation"' points to the 'Remarks' field.
- 'Restore original texts' points to the left arrow button.
- 'Send texts to the recorder' points to the right arrow button.



The plant pages (batch pages) only match the pages in the recorder if the factory setting of the instrument has been retained. If plant data have been changed in the recorder, HTML pages must be updated to reflect the changes.

10.5 QuadView

Visualization for up to four devices is possible with QuadView. The visualizations may involve one device or up to four different ones. Different visualizations can be activated for each display (for example two views of a device, curve presentation and bar graph display).

Before QuadView can be used, the function must be configured.

- * (Left) click "Setup".



Setup

The setup window appears, where all IP addresses in use can be configured.

Configuration of Quad View isn't done. Please fill out adresse fields and save config.

Quad View - Setup

Quad View	
Adress 1 <input type="text"/>	Adress 3 <input type="text"/>
Adress 2 <input type="text"/>	Adress 4 <input type="text"/>

If all or some fields are empty, they have not been configured for QuadView yet.

- * Complete the configuration and click "Save config".

10 Web server

Result: IP addresses (or DNS names) that have been entered are saved as cookies in the PC and remain intact until cookies are deleted (forexample by the PC browser).

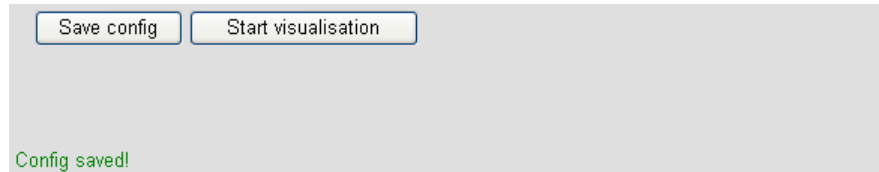

* Click "Start" or "Start visualization".

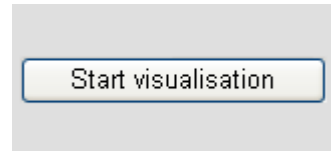

Result: QuadView starts.

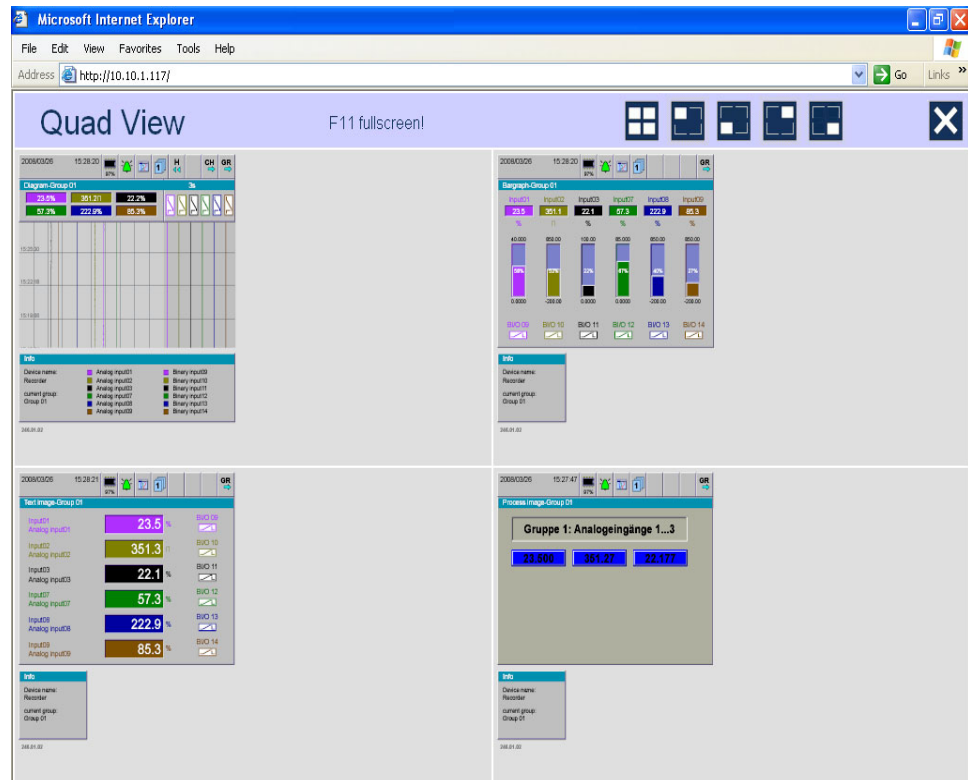

In the example shown here, two different recorders are accessed (recorder 1 top left and top right, recorder 2 bottom left and bottom right). Two different visualizations are shown for each recorder.

Switching between the four visualizations works as shown in Chapter 10.2 "Online Visualization (All Visualizations Except Batches)".

Unlike a normal online visualization, the header contains modified buttons.

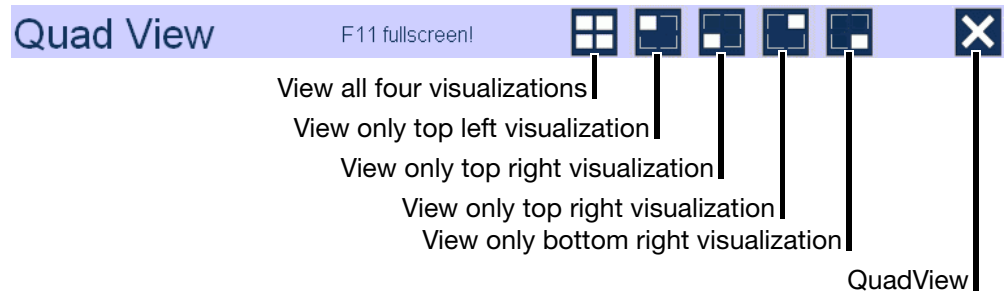

10 Web server

10.6 General information

The web server is integrated into the paperless recorder as standard. Three different display types are available:

- "Online Visualization (All Visualizations Except Batches)"
- "Online Visualization of Current Batch Reports"
- "QuadView"

The web server can be queried from the PC with the following programs (among others) without a SVG viewer having to be installed.

- Microsoft Internet Explorer 11
- Mozilla Firefox 26.0
- Google Chrome 32.0

The web server starts when the IP address (e.g. `http://10.11.101.102`) or the DNS name is entered.



A maximum of 4 PCs (clients) can access the device (server) at the same time via the Ethernet connection.

Logon

A password query is active per default. The user can set this query to inactive in the setup program.



User name and password are case sensitive.

Default settings
User = Master
Password = 9200

Start page

The start page is automatically shown after a successful logon.

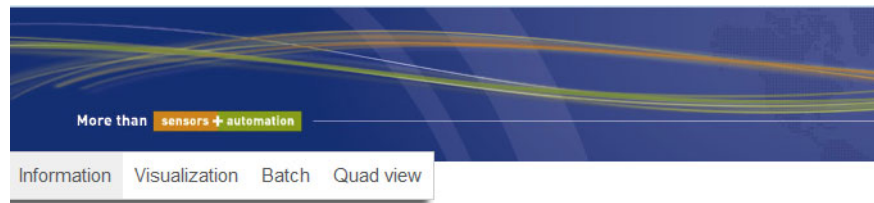

JUMO LOGOSCREEN nt/fd



Paperless recording of analog and digital process data.

JUMO. More than **sensors+automation**

Distribution

The display of the web server is divided into two areas:

- Navigation
- Visualization area

Navigation

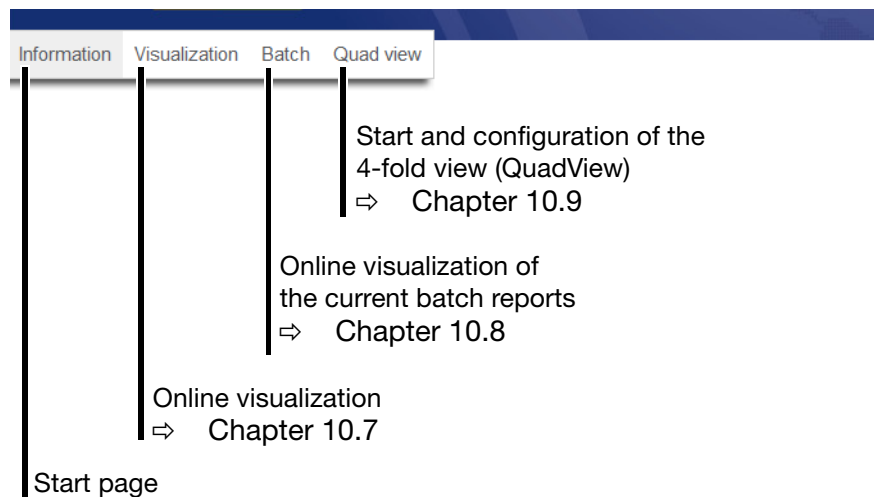

The individual pages can be accessed by clicking the left mouse button.

10 Web server

Visualization area

The visualization area shows the current data from the paperless recorder. Updating occurs automatically through the web server.

JUMO LOGOSCREEN nt/fd



Paperless recording of analog and digital process data.

JUMO. More than **sensors+automation**

10.7 Online visualization (all visualizations other than batches)

The operation conforms to the operation as described in Chapter 10.2.

10.8 Online visualization of the current batch reports

If batch reports from a plant are requested then the current data is extracted from the recorder and shown.

Display available batch report

Click text edit fields (marked in yellow) with the left mouse button and enter text (once authorization has been obtained)

Program name Text 01
Customer info Text 03
Batch name Text 05
Batch number 000000000Text 07
Batch start
Batch end
Batch duration 00:00

Remarks

set edit mode on send

The "attachment" can be viewed at the recorder in the "Completed batch" visualization using the "Batch evaluation" function.

Send texts to the recorder

Allow editing (release) or do not allow



Texts that are sent to the recorder are reset at the end of a recording by the device and must be re-sent.

10 Web server

10.9 QuadView

Up to four devices can be visualized with the 4-fold view (QuadView). This applies to the same device or to two to four different devices. For each display, different visualizations can be activated (e.g. the curve presentation and the bar graph display of a device in two views).

Before the 4-fold view can be used the function must first be configured.

Configuration * Left-click "[+]"

[-] [+]

[+] [+]

* Enter the IP address or the DNS name in the corresponding field and finish the input by clicking the "Ok" button.

[-]

Result: the entered IP addresses (or DNS names) are saved on the PC as cookies and therefore remain until the cookies are deleted (e.g. with the PC browser). Visualization starts automatically.



Delete configuration

[-]



By left-clicking "[-]" the configuration will be deleted and new addresses can be entered.

11.1 Bar code

11.1.1 Batch control

Plant 1



BATCH1

Plant 2



BATCH2

Plant 3



BATCH3

Start



START

Stop



STOP

Reset
entry



RESET

11 Appendix

11.1.2 Batch texts

Product name SUPER PRODUCT



SUPER PRODUCT

NORMAL PRODUCT



NORMAL PRODUCT

TOOTHED DISK 34



TOOTHED DISK 34

AXIS ROD 45



AXIS ROD 45

Product numbers 645736



645736

012876



012876

345435



345435

Job numbers

A83737



A83737

A4555455



A4555455

A455445



A455445

**Personnel
number**

4576



4576

7665



7665

Numerics

1-channel presentation 34
4-fold view 85, 92

A

Alarm and event lists 20, 51
Alarm limits 32–34
Alarm lists 51
Arrangement of the documentation 8
Audit trail 67

B

Backup -> CF card 57
Bar code 41, 95
Bar graph presentation 29–30, 33
Batch 29–30, 38
 analyze 40
 automatic start 39
 change 38, 40
 edit 38
Batch start/stop 39
Batch status 39
Batches 26, 45, 51
 Start manually 38
Binary 29
Binary presentation 30, 35

C

CF card -> config. data 57
CF card -> user list 57
Change password 60
Channel description 34
Channel name 34
Channel step-on 20, 31, 37, 48
Color display 15, 17
Comment Entry 45
Comment entry 29–30
Commissioning 7
CompactFlash 9, 15–16
Completed batches 40
Config data -> CF card 57
Configuration 68
Control knob 14–15, 17, 19
Counter 44
Counters/integrators 29–30, 44
Cursor 48

Curve presentation 29–32, 36

D

Data readout
 via interface 55
 with a CF memory card 55
Device Information 62
Device Manager 59
Device manager 20
Diagram header 20, 36
Diagram view 22
Display 15, 17
Display off 16
Displays and controls 15
DNS 78

E

Edit batch 39
Electrostatic discharge (ESD) 7
Entering values 75
Eth. info 66
Event lists 51
Event mode 31
Ext. texts 65

F

Factory setting 69
Firmware 57

G

Group 45
Group presentation 34
Group selection 20, 31, 37
Group step-on 20, 31, 37
Groups 26

H

Hardware 63
Header 16, 19
History 20, 47
horizontal presentation 32, 36

I

Info 63
Installation Instructions 13
Instrument documentation in printed form 8
Instrument documentation in the form of PDF files 8
Integrators 44
Introduction 7
IP address 78, 88

K

Keys 11

L

Log-in 60
Log-in and Log-out 60
Log-out 60

M

Max. value 37
Memory manager 20
Memory managers 55
Memory presentation 20, 31, 47
Module 64

N

Normal display 24
Normal mode 31
Note signs 10
Numerical measurement display 16, 20, 22, 31, 48

O

Operating mode 31
Operator level 20, 24, 29

P

Parameterization 68
Password 60, 78, 88
Password management 57
PCA3000 9
PCC 9
Plant 38
Plants 26

12 Index

Power LED 15, 17
Presentation modes 11
Process image presentation 29–30, 35

Q

QuadView 85

R

Report 29–30, 37
Report step-on 37
Returning 7
Rights 60

S

Sampling rate 31
Save all + update CF card 57
Screen saver 16
Screen texts 11
Scroll 48
Search 48
Service 69
Stainless steel 14
stainless steel 13
Status bar 16, 21
Status LED 15, 17
SVG 78
Symbols 23, 54

T

Text entry 71
Text picture presentation 29–30
Textual presentation 34
Time period 37
Timed mode 31
Title bar 16, 21
Touchpad 14, 17, 19
Typographical Conventions 10

U

Update CF card 57
USB 16, 55–57
User 78
User list 57
Users 59–60, 88

logged in 59
logged out 59
Standard (default) password 60
Standard (default) user 60

V

Version 62
vertical presentation 31, 36
Visualization 20, 29
Visualization window 16, 23

W

Warning signs 10
Warranty 7
Web server 78, 88
Writing configuration data to CF card / reading from CF card 57

Z

Zoom 48



JUMO GmbH & Co. KG

Street address:
Moritz-Juchheim-Straße 1
36039 Fulda, Germany
Delivery address:
Mackenrodtstraße 14
36039 Fulda, Germany
Postal address:
36035 Fulda, Germany
Phone: +49 661 6003-0
Fax: +49 661 6003-607
E-mail: mail@jumo.net
Internet: www.jumo.net

JUMO Instrument Co. Ltd.

JUMO House
Temple Bank, Riverway
Harlow - Essex CM20 2DY, UK
Phone: +44 1279 63 55 33
Fax: +44 1279 63 52 62
E-mail: sales@jumo.co.uk
Internet: www.jumo.co.uk

JUMO Process Control, Inc.

6733 Myers Road
East Syracuse, NY 13057, USA
Phone: 315-437-5866
1-800-554-5866
Fax: 315-437-5860
E-mail: info.us@jumo.net
Internet: www.jumousa.com