

LOGOSCREEN es
Paperless Recorder
for secure acquisition
of FDA-compliant
measurement data

B 70.6560.1
Operating Instructions

Menu structure of the paperless recorder

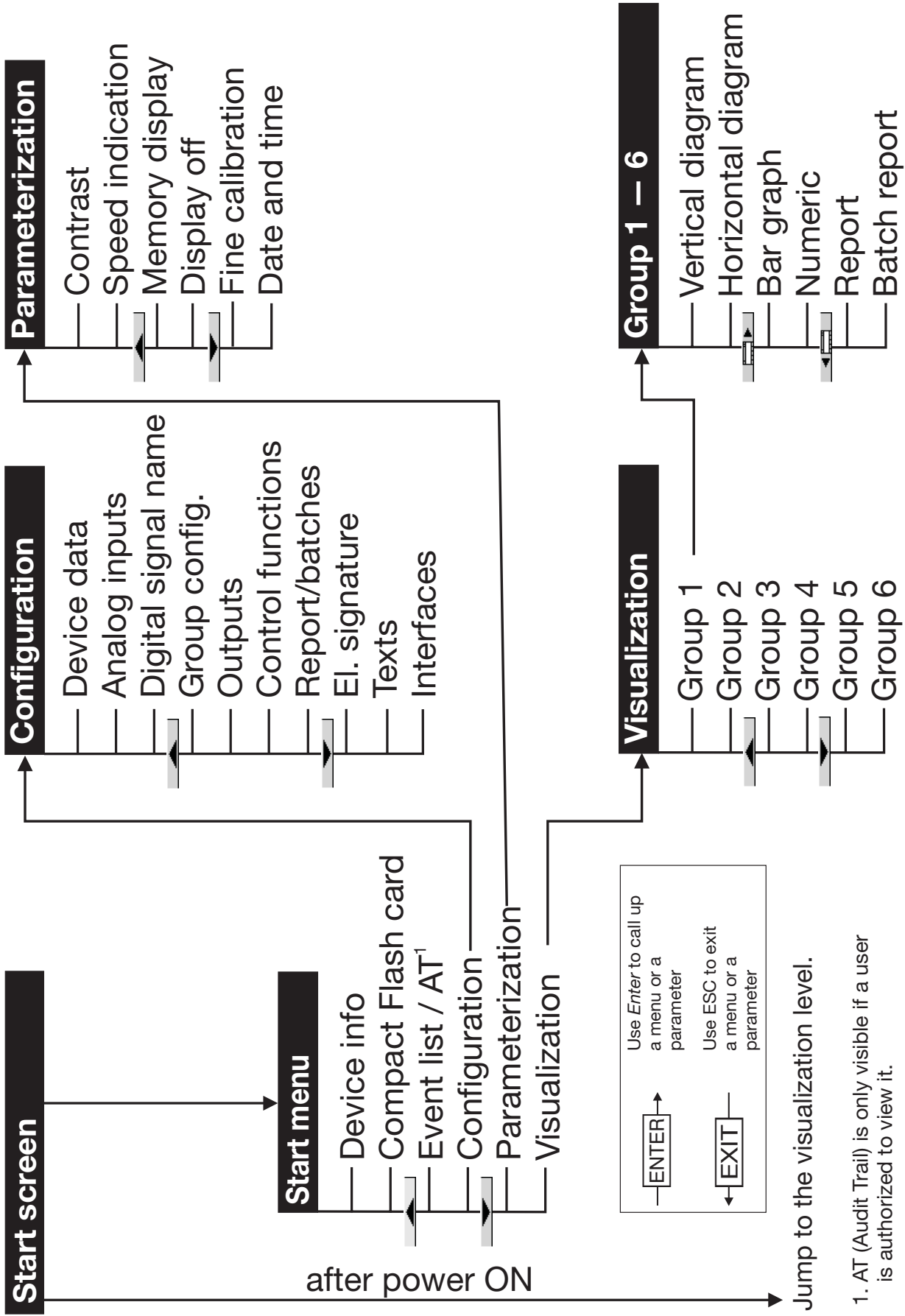

| | | |
|----------|---|-----------|
| 1 | Introduction | 5 |
| 1.1 | Preface | 5 |
| 1.2 | Arrangement of the documentation | 6 |
| 1.3 | Typographical conventions | 9 |
| 2 | Instrument description | 11 |
| 2.1 | Displays and controls | 11 |
| 2.2 | Operating principle and graphic elements | 14 |
| 3 | Operation and visualization | 17 |
| 3.1 | Start menu | 18 |
| 3.1.1 | Overview | 18 |
| 3.1.2 | Logging in and logging out | 19 |
| 3.2 | Visualization | 23 |
| 3.2.1 | Vertical diagram | 24 |
| 3.2.2 | Horizontal diagram | 25 |
| 3.2.3 | Evaluation of the stored measurement data | 26 |
| 3.2.4 | Bar graph representation | 29 |
| 3.2.5 | Numerical representation | 30 |
| 3.2.6 | Numerical 1-channel representation | 31 |
| 3.2.7 | Reports | 32 |
| 3.2.8 | Batch reports | 33 |
| 3.3 | Parameterization | 43 |
| 3.4 | Configuration | 46 |
| 3.5 | Event list / AT | 47 |
| 3.5.1 | Event list | 47 |
| 3.5.2 | Audit trail list | 50 |
| 3.6 | CompactFlash card | 51 |
| 3.7 | Device info | 55 |
| 3.8 | Text entry | 57 |
| 4 | Index | 59 |

Contents

1.1 Preface



Please read this Operating Manual before commissioning the instrument. Keep the manual in a place that is accessible to all users at all times.

Please assist us to improve this operating manual, where necessary.

Your suggestions will be appreciated.



However, if any difficulties should arise during start-up, please do not carry out any manipulations. You could endanger your rights under the instrument warranty!

Please contact the nearest subsidiary or the head office in such a case.



When returning modules, assemblies or components, the regulations of EN 61340-5-1 and 61340-5-2 "Protection of electronic devices from electrostatic phenomena" must be observed. Use only the appropriate **ESD** packaging for transport.

Please note that we cannot accept any liability for damage caused by ESD.

ESD=electrostatic discharge

1 Introduction

1.2 Arrangement of the documentation

The documentation for this instrument is addressed to equipment manufacturers (OEMs) and users with appropriate technical expertise. It consists of the following parts:

Sales documentation in the form of PDF files

White Paper The JUMO White Paper presents the company's position on the regulation “21 CFR Part 11” of the American health authority FDA (Food and Drug Administration). With each section of the regulatory text, the user is given information on the fulfillment of the requirements.

Product description The product description illustrates the security and operating concepts behind the system, and the results that can be achieved by JUMO in the course of validation of an installation. It is intended to serve as an introduction to the system, and not as a formal technical document.

Instrument documentation in printed form

B 70.6560.1 **Operating Instructions**

The operating instructions are an extract from the operating manual and cover the basic operation of the paperless recorder.

B 70.6560.4 **Installation Instructions**

The installation instructions describe the installation of the recorder and the connection of the supply and signal cables. The instructions also contain a list of the technical data.

Instrument documentation in the form of PDF files

The “Instrument documentation in the form of PDF files” is on the CD that comes with the delivery.

B 70.6560.0 **Operating Manual**

It contains information about commissioning, operation and parameterization on the instrument, as well as about the PC setup program (available as an option).

B 70.6560.1 **Operating Instructions**

The operating instructions are an extract from the operating manual and cover the basic operation of the paperless recorder.

- B 70.6560.2.0** **Interface Description (Modbus)**
- This provides information on the communication (RS232; RS422/RS485) with supervisory systems.
- Interface Description (Ethernet interface)**
- This provides information on the connection of a paperless recorder to a company-internal network. The description is integrated in the B 70.6560.2.0.
- B 70.6560.2.1** **Interface Description (LON interface)**
- This provides information on the connection and use of modules of the “JUMO mTRON automation system”.
- B 70.6560.2.3** **Interface Description (PROFIBUS-DP interface)**
- This provides information on the connection of a paperless recorder to a PROFIBUS-DP system.
- B 70.6560.4** **Installation Instructions**
- The installation instructions describe the installation of the recorder and the connection of the supply and signal cables. The instructions also contain a list of the technical data.
- T 70.6560** **Data Sheet**
- The data sheet contains general information, the order details and the technical data.
- B 70.9701.0** **PC Evaluation Software (PCA3000)**
- The operating manual describes the operation and the features of the PC evaluation software.
- PCA3000 serves to visualize and evaluate process data (measurement data, batch data, messages, instrument audit trails, ...). The process data can be read in via the CompactFlash memory card, or made available through the PCC software.
- B 70.9702.0** **PCA Communications Software (PCC)**
- The operating manual describes the operation and the features of the PCA communications software.
- PCC is responsible for the data transfer from the recorder to a PC, or to a network.
- B 70.9703.0** **PC Security Manager Software (PCS)**
- The operating manual describes the operation and the features of the PC Security Manager software.
- The PCS ensures that only authorized persons can gain access to the system components (instrument, PC software) and use electronic signatures on electronic documents.
- The configuration of the Security Manager can only be performed by the system administrator.

1 Introduction

B 70.9704.0

PC Audit Trail Manager Software (PCAT)

The operating manual describes the operation and the features of the PC audit trail manager software.

PCAT documents actions performed in the PC software components, which lead to modifications of files, user lists (rights files), device lists etc. The different message types are: "Information", "Warnings" and "Errors".

Audit trail records cannot be modified.



Device audit trail data are not shown in PCAT, only in PCA3000.



All documents are available for downloading at: www.jumo.net

1.3 Typographical conventions

Warning signs

The symbols for **Danger** and **Caution** are used in this manual under the following conditions:



Danger

This symbol is used when there may be **danger to personnel** if the instructions are ignored or not followed correctly!



Caution

This symbol is used when there may be **damage to equipment or data** if the instructions are ignored or not followed correctly!



Caution

This symbol is used where special care is required when handling **components liable to damage through electrostatic discharge**.

Note signs

Note



This symbol is used when your **special attention** is drawn to a remark.

Reference



This symbol refers to **further information** in other manuals, chapters or sections.

Footnote

abc¹

Footnotes are remarks that **refer to specific points** in the text. Footnotes consist of two parts:

A marker in the text, and the footnote text.

The markers in the text are arranged as continuous superscript numbers.

Action

*

This symbol indicates that an **action to be performed** is described.

The individual steps are marked by this asterisk, e.g.

* Press the  key

* Confirm with 

1 Introduction

Representation

Keys

 + 

Keys are **shown in a box**. Both **symbols and text** are possible. If a key has a multiple function, then the text shown is the one that corresponds to the function **that is active at the moment**.

Screen texts

*Program
Manager*

Texts that are displayed in the setup program are indicated by **italic script**.

Menu items

*Edit →
device data*

Menu items in the setup and instrument software referred to in this manual are shown in italics. Menu name, menu item and submenu item are separated from each other by “→”.

2 Instrument description

2.1 Displays and controls

Power LED (green)

is on continuously as soon as power is applied.
Flashes when screen saving is active.
Pressing any key will de-activate screen saving.

Status LED (red)

is on continuously while an alarm is present

Color display

320 x 240 pixel, 27 colors

Cover

for the CompactFlash[®] slot¹
and the setup plug connection

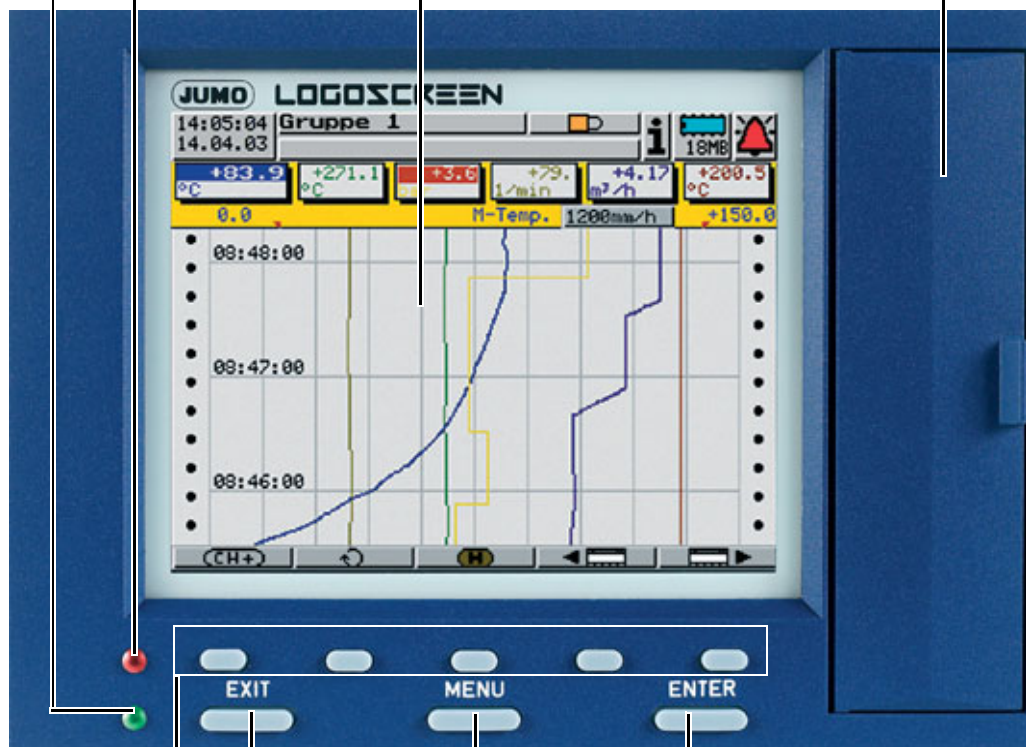

Enter

- select menu item
- enter selection

Menu

back to the start menu²

Exit

- previous window
- cancel current action

Softkeys

screen-dependent functions, represented by text or symbols

1. CompactFlash[®] is a registered trademark of the SanDisk Corporation.

2. Not from the configuration level if a parameter has already been modified there.

2 Instrument description

CompactFlash slot

for exchanging data (measurement data, configuration data, user lists) between the recorder and the PC

Signal LED; lights up on accessing the CompactFlash memory card. The card must not be removed while being accessed.

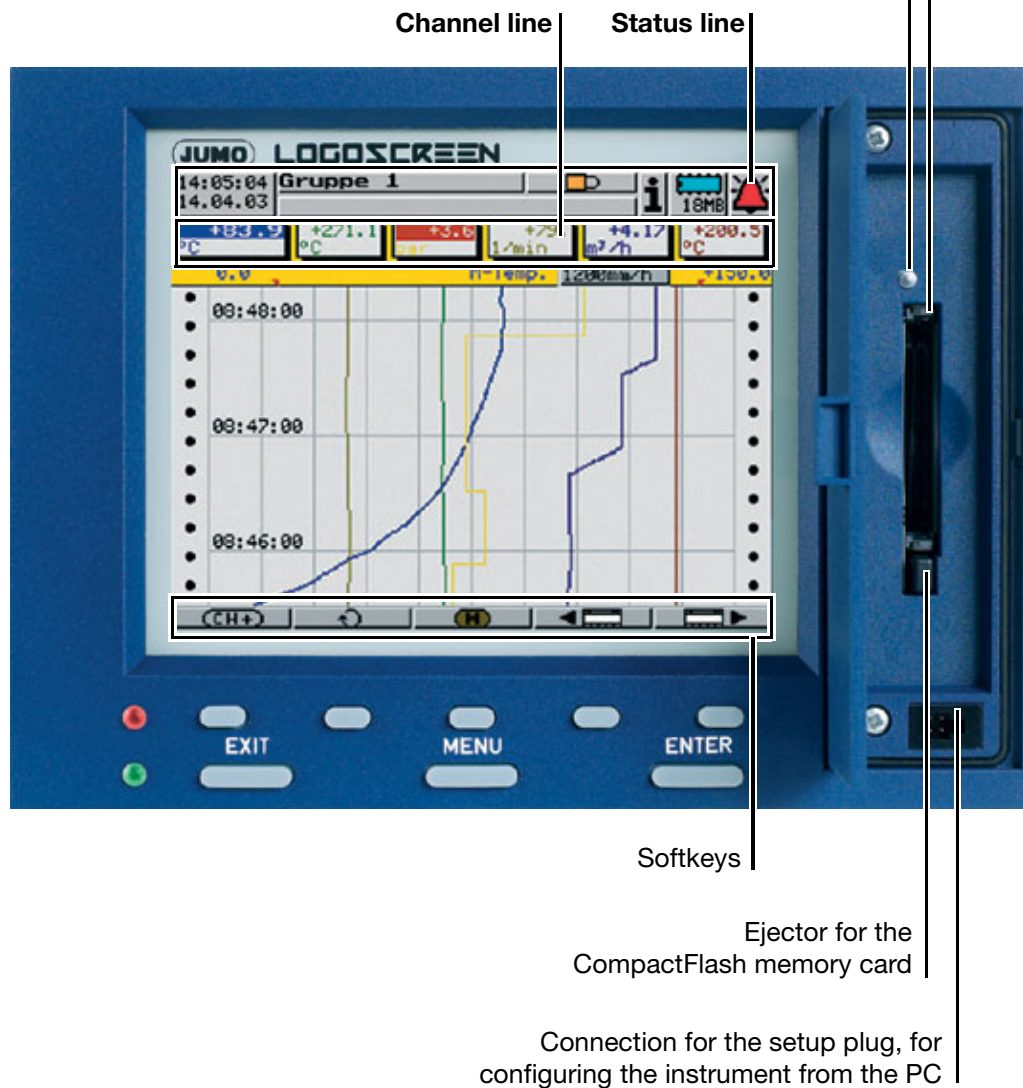

The life of the background illumination can be prolonged through the parameter "Display off" (screen saving).



The CompactFlash memory card must not be removed during access (signal LED is on).

2 Instrument description

Version with
stainless steel
front

Status LED (red)

is on continuously while an alarm is present

Power LED (green)

is on continuously as soon as power is applied.

Flashes when screen saving is active.

Pressing any key will de-activate screen saving.

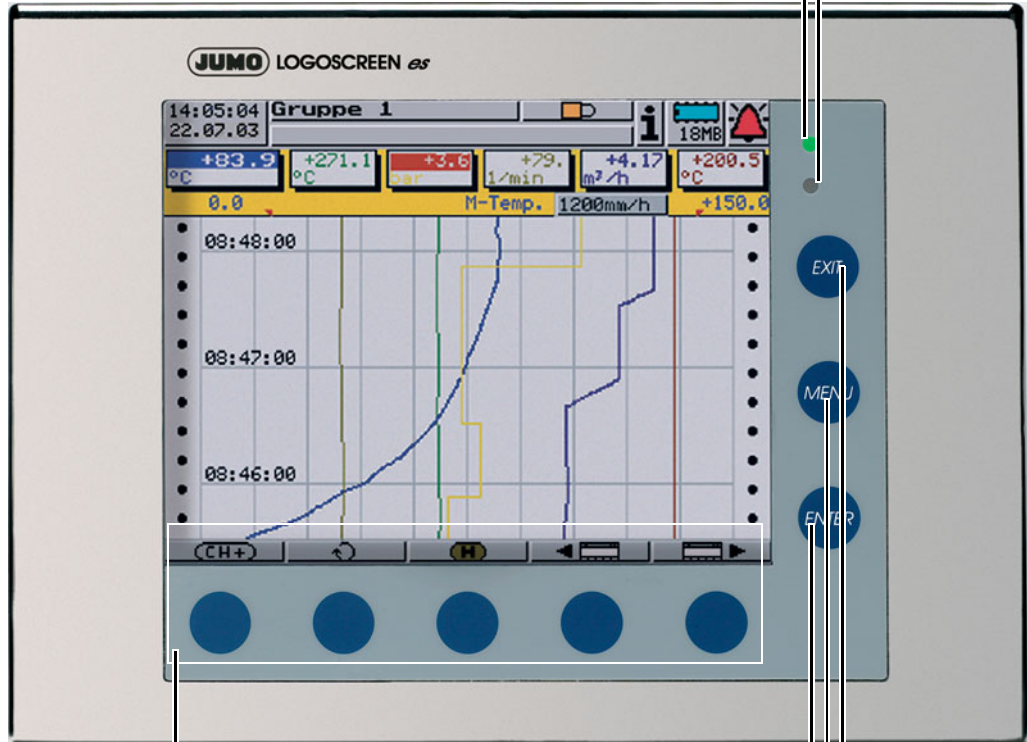

Softkeys

screen-dependent function,
represented by text or symbols

Exit

- previous window
- cancel current action

Menu

back to the start menu

Enter

- select menu item
- enter selection



On the stainless steel version, the CompactFlash slot and the setup plug connection are located at the instrument rear.

2 Instrument description

2.2 Operating principle and graphic elements

Keys The recorder is operated from eight keys. Three of these have fixed functions, the other five (softkeys) have screen-dependent functions.
⇒ Chapter 2.1 “Displays and controls”

Softkeys The functions of the softkeys appear in the bottom line of the display, as symbols or in plain text.



Status line The status line is shown in the top section of the display. It provides information on important actions and states. The status line is always visible, irrespective of the level (operation, parameters, configuration).

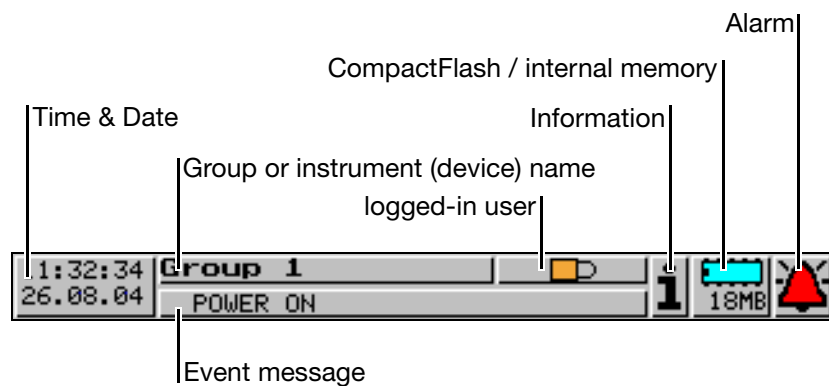



Time & Date

shows the current time and date

Group or instrument name

The visualization displays show the group name. All other menus show the instrument name.

Logged-in user

If the symbol  appears in the display, no user is logged into the recorder. If somebody is logged in, then the user name is shown here (e.g. .

Event message

shows last entry in event list

Information



The egg timer appears whenever the instrument is busy and can therefore not be operated.



The “H” informs you that the indicated measurements are derived from the past (history). The data in the RAM are shown.



In the event of an error, an “i” flashes here. The cause of the error can be read out from the instrument (device) info window (⇒ Chapter 3.7 “Device info”).



If the keys are inhibited, a key flashes in this position.

2 Instrument description

CompactFlash / internal memory

indicates the free capacity of the CompactFlash memory or the internal backup memory. Which symbol is shown, can be set in the "Parameterization" menu.

⇒ Chapter 3.6 "CompactFlash card"



Free capacity of the CompactFlash memory card.



Free capacity of the internal backup memory.

This turquoise symbol is shown when the data are read out via the CompactFlash memory card.



Free capacity of the internal backup memory.

This dark blue symbol is shown when the data are read out via the serial interface or the Ethernet interface.

Alarm

If an alarm occurs (e.g. out-of-limit), the (alarm) bell flashes in this field.

Channel line

The channel line shows the measured values for the active channels of the group together with their unit. In addition, alarms and out-of-range conditions are made directly visible in this line.

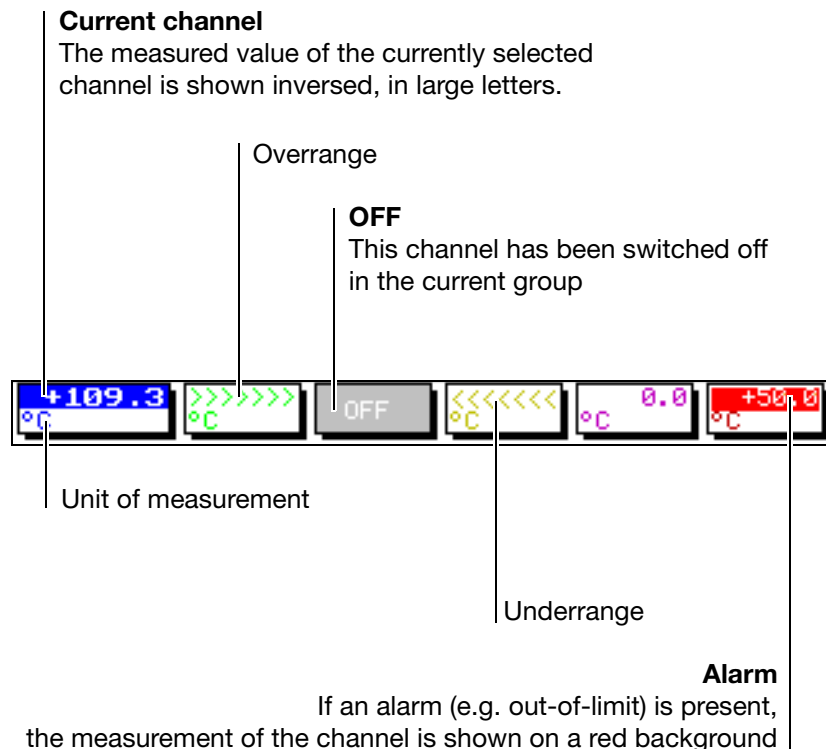

2 Instrument description

3 Operation and visualization

After starting up the paperless recorder by switching on the supply (power ON), you will see the start logo (company logo).

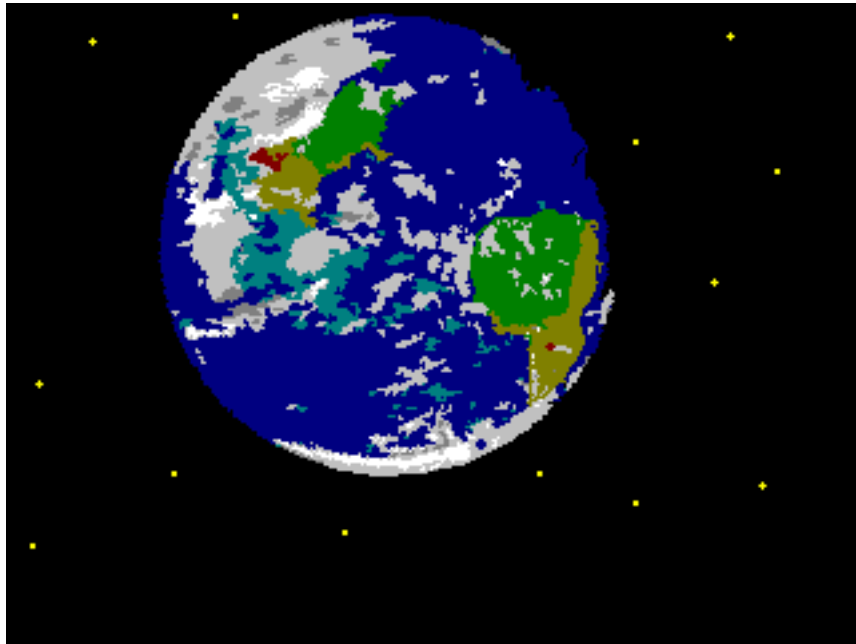

During screen build-up, the recorder is initialized with the data of the last configuration.



After the initialization phase, the view that was last selected at the visualization level is shown, provided that it was active at the time when the instrument was switched off (power OFF).

If this is not the case, the start menu is displayed.

3 Operation and visualization

3.1 Start menu

3.1.1 Overview

The start menu is the central point from which the various instrument levels branch out.

The following levels are available:

- visualization,
- parameters
- configuration
- event list / AT (audit trail),
- CompactFlash card and
- device info

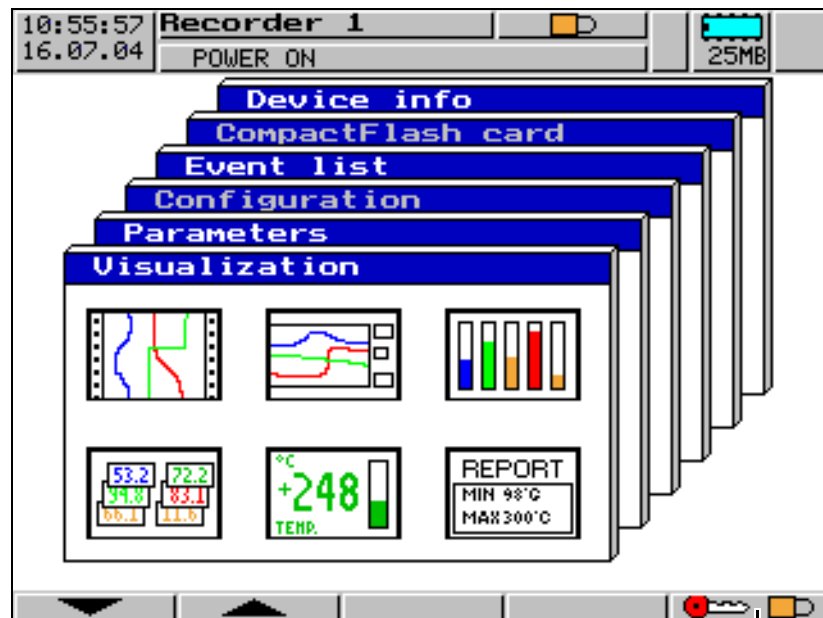

Log in and log out

- * Select the required level
- * Enter selection with **ENTER**

The start menu is displayed:

- after pressing the **MENU** key¹
- after (repeatedly) pressing the **EXIT** key

1. Not from the configuration level, if a parameter has already been modified there.

3 Operation and visualization

3.1.2 Logging in and logging out

Logging in and logging out is one of the most important functions of the recorder.



Logging in and logging out

- * Call the “Log-in and log-out” function, and the following menu is started automatically:



- * Select the required function
- * Enter selection with **ENTER**

The following functions are available in the menu:

- log in,
- log out (only if logged in) and
- change password

- * Select the desired function und press **ENTER**.

Standard (default) users



The recorder is delivered ex-factory with an internal user list which comprises two users.

User 1: Master Password: 9200

User 2: User Password: 0

Through the PC Security Manager Software, another user list (device rights file) can be created and transferred to the instrument.

3 Operation and visualization

Logging in

- * Select ID (user name) and confirm with **[ENTER]**.



- * Enter password via softkeys.



If the simplified password entry has been switched off by the PC Security Manager Software (PCS), please enter the password as described in Chapter 3.8 “Text entry”.

- ⇒ Additional information about the PC Security Manager Software (PCS) can be found in the Operating Manual B 70.9703.0.
- * Conclude password entry by pressing the **[ENTER]** key.

This position shows
the logged-in user



An error message is output for wrong entries.
Please confirm the message by pressing any key, then repeat entry.

3 Operation and visualization

Logging out

- * Select the “Log-out” function.

The user who is currently logged in is shown on the screen.

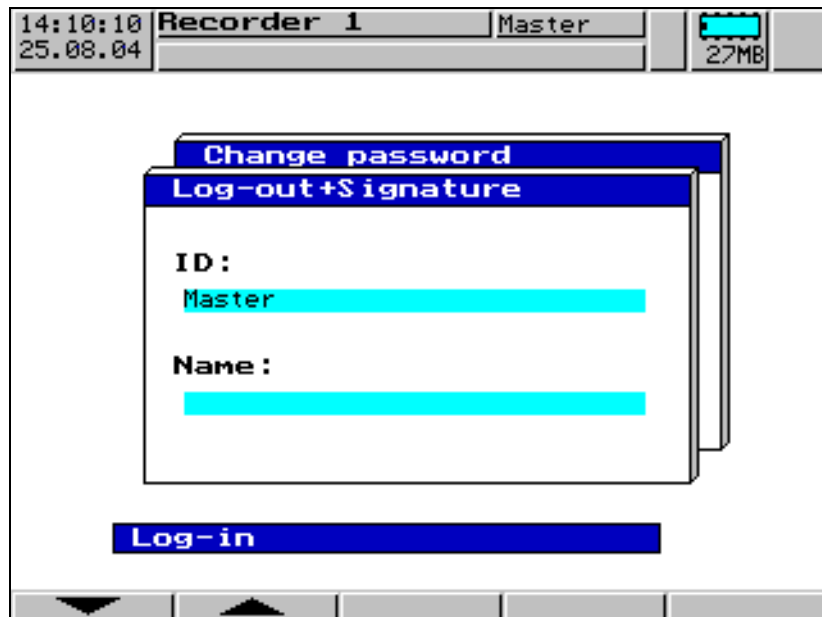

- * Please press **ENTER** to log out.

Logging out without signature

If it was established in the PC Security Manager Software (PCS) that **no signature** has to be executed when logging out, you are logged out now.

Logging out with signature

If it was established in the PC Security Manager Software (PCS) that **a signature** has to be executed when logging out, proceed as follows:

- * Enter details about the “significance of the signature” (conclude entry with **ENTER**).

Configuration of the parameter *El. signature* → *Text list signif.* → *for log-out* → *Text list?* determines whether a query is made. If the parameter is set to “Yes”, a query is made.

- * Enter your password (conclude with **ENTER**).
- * Confirm the security information by pressing **ENTER**.

You are logged out now.



Wrong entries will produce an error message. Confirm the message with **EXIT** and repeat entry.

3 Operation and visualization

Altering the password

- * Select the function “change password” and press the **ENTER** key.

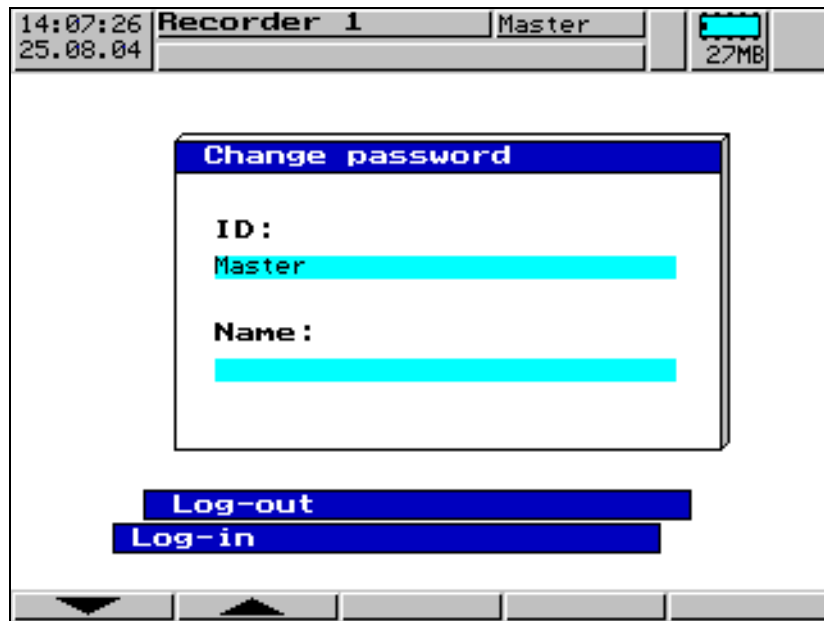

- * From the list, select the user who the password has to be altered for, and confirm with **ENTER**.
- * Enter the current password (conclude with **ENTER**).
- * Enter the new password (conclude with **ENTER**).

The new password is entered as described in Chapter 3.8 “Text entry”.

- * Enter the new password once more (via the softkeys).
Conclude entry with **ENTER**.

If the entry was free from errors, then the new password is active now.



Wrong entries will produce an error message.
Confirm the message with **EXIT** and repeat entry.

3 Operation and visualization

3.2 Visualization

Start menu → Visualization After selecting the level *Start menu → Visualization*, the group manager appears.

Group manager The instrument manages six visualization groups of measurement inputs. Each group can consist of up to six analog and three digital channels. Operation within the visualization level is always group-oriented.

Group window

The current analog and digital measurements, as well as the channel name, are displayed here.

The group name is shown on a red background in the window title if an alarm is present within the group. The measurement of the channel which triggered the alarm is also shown on a red background.



If an alarm is present within a group, the alarm bell is shown flashing.

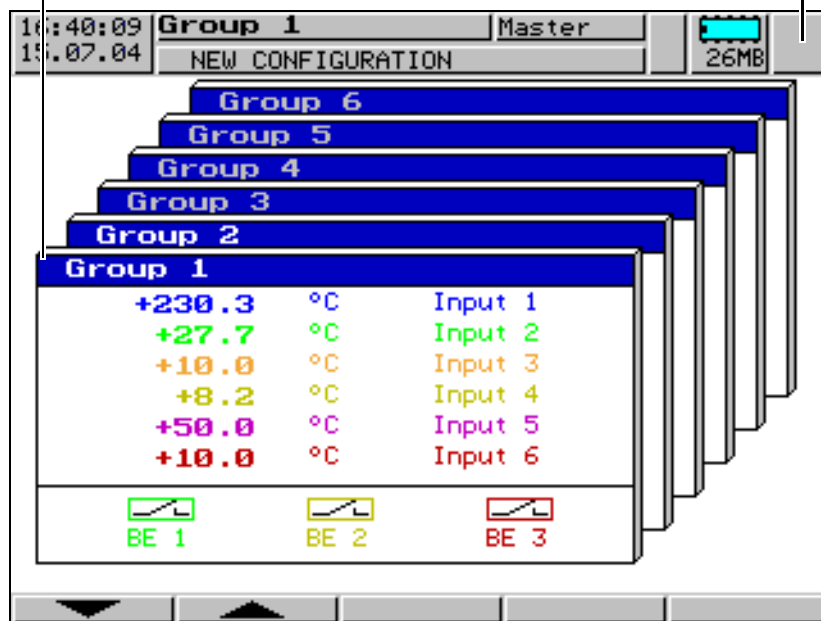

* Select group



Confirmation of a group with `[ENTER]`, is followed by a switch to vertical diagram representation.

3 Operation and visualization

3.2.3 Evaluation of the stored measurement data



It is possible to evaluate the measurement data of a group if the status of the group (*Group status*) has been configured to *Displ.+store*.

History



Using this function, all measurement data of the internal RAM (approx. 350,000 measurement data for all groups) can be displayed and evaluated.

Evaluation of the measurement data can be carried out in the horizontal and vertical diagrams. Since the same principle applies to both representation types, the example describes the vertical diagram.

The softkey function changes during evaluation and, in addition, the current zoom factor and cursor position (date and time) are displayed.

Older data from the internal backup memory can only be evaluated after data transmission using the PC Evaluation Software (PCA3000).

Scroll operation

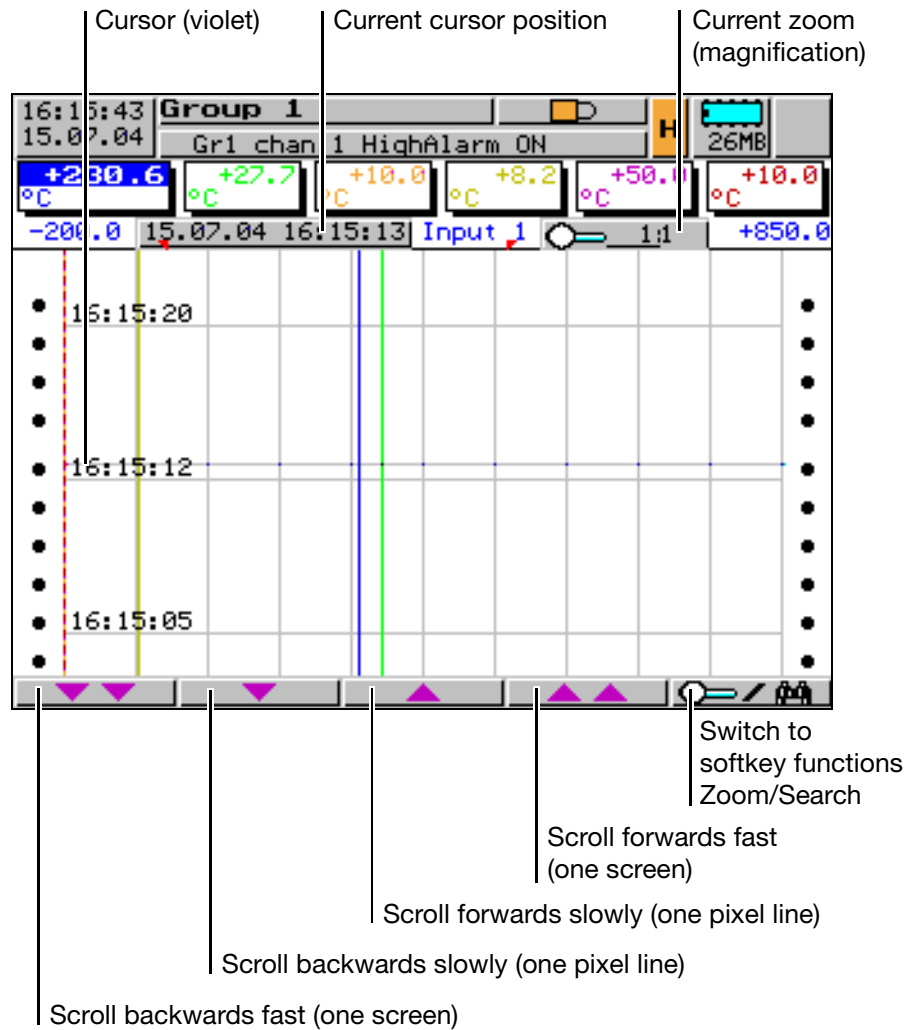

Using these softkeys, the measurement data display can be scrolled (shifted) on the screen within the measurement data stored in the SRAM.

3 Operation and visualization

Zoom

If the zoom factor has to be adjusted, or specific values have to be searched, then it is necessary to switch the softkey functions.

* Press  softkey

The degree of compression of the measurement data on the screen is given as a ratio in steps (1:1, 1:2, 1:5, 1:10, 1:20, 1:50 and 1:100).

For instance, 1:100 means that 1 screen pixel corresponds to 100 measurements.

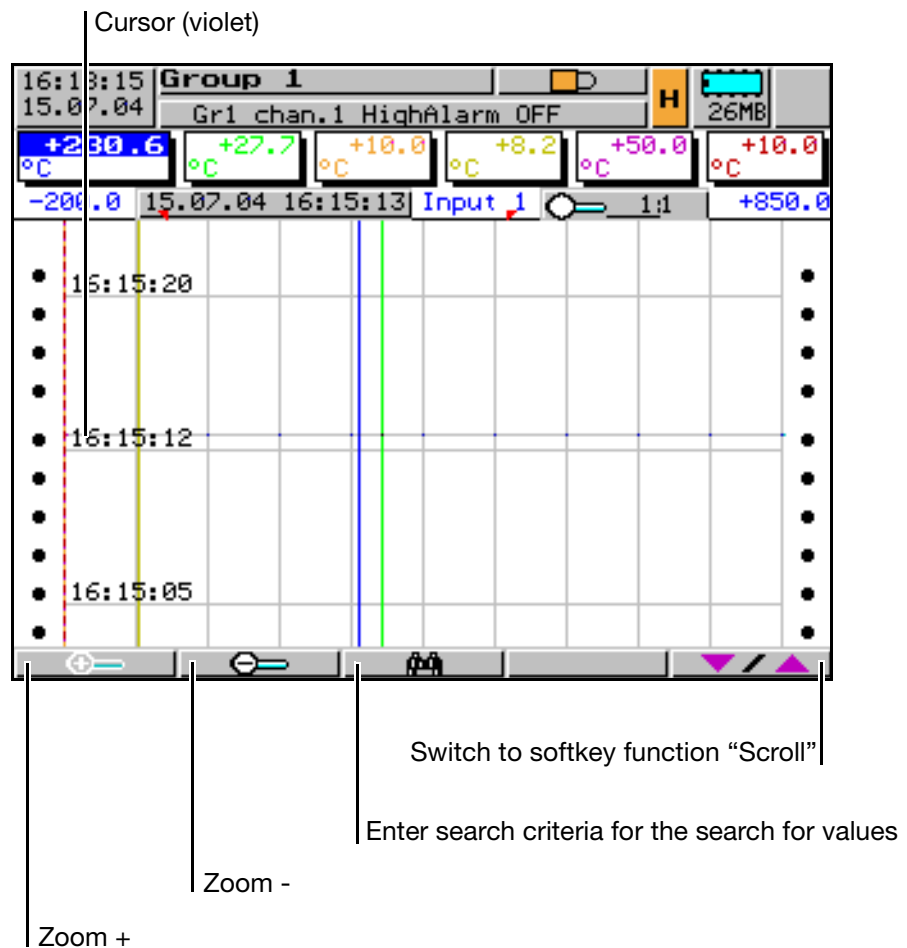

Search criteria



Several search criteria can be employed in the search for values:

- Limitation to a time period within the stored measurement data.
If no comparison operator is defined, a search is made for the set start time. The measurements are shown, as far as they are available.
- Comparison of the measurements of a channel against a comparison value.
If the search has been successful, the position is shown in the center of the screen, below the cursor.
- Combination (AND, OR) of the measurement check on a channel with a second measurement check on the same or another channel.

3 Operation and visualization

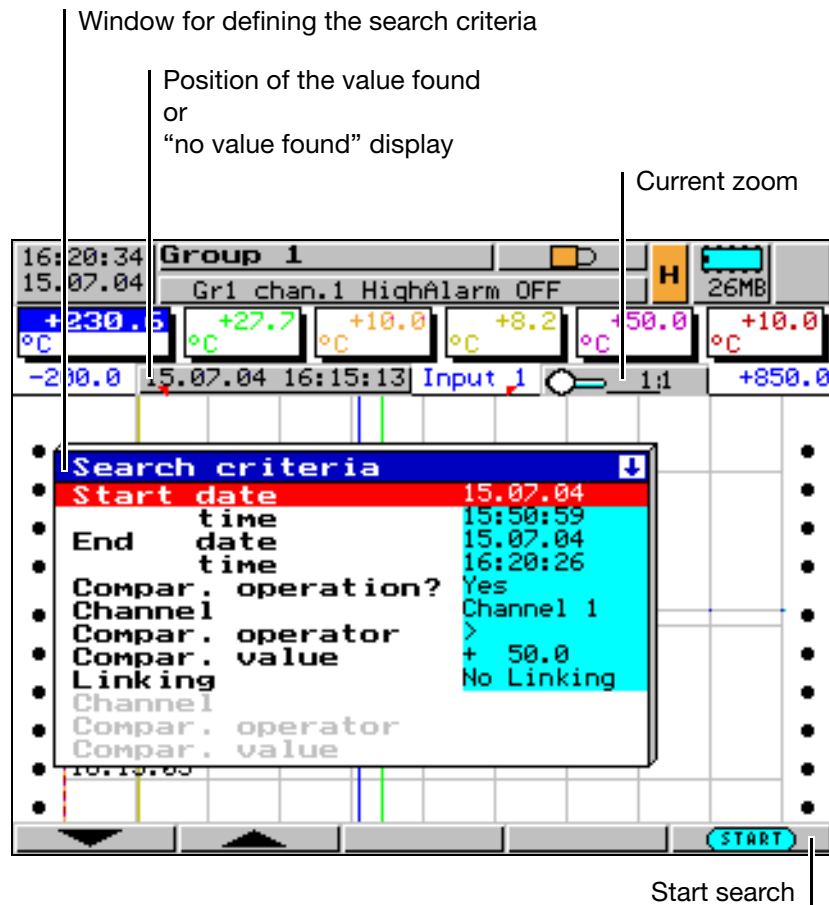

The example above shows the search for the first occurrence of a measurement >50 on channel 1 on the 15.07.04 within the period from 15:50:59 to 16:20:26.

Search result

Two results are possible:

- no (further) value was found (display: "no value found")
- a value which fulfils the search criteria was found

"no value found"

If no (further) value was found, the text "no value found" is shown in the cursor position field.

Value found

If a (further) value was found, the measurement representation is shifted in such a way as to display the value that was found in the center of the displayed range. The cursor (violet line) is positioned there.

Continue search

If a (further) value was found which meets the search criteria, the softkey can be used to search for further values until no further value is found.



3 Operation and visualization

3.2.4 Bar graph representation

In bar graph representation, the latest measurements of the group are shown as bar graphs, in addition to the numerical display.

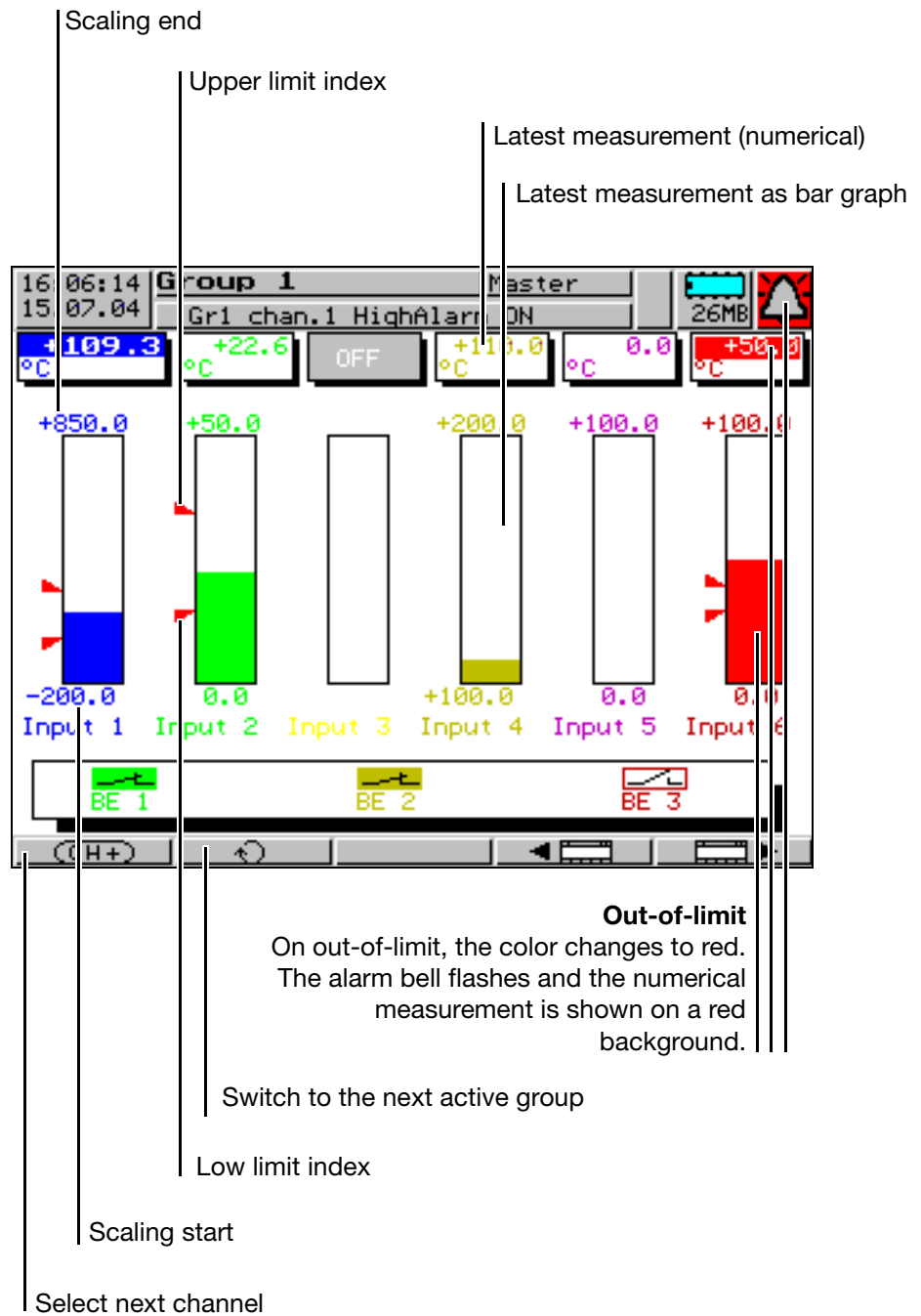

3 Operation and visualization

3.2.5 Numerical representation

In numerical representation, the currently measured values of a group are shown in large characters. The exact measurements can then be read easily from a distance of several meters.

The window of the selected channel is in the foreground so that the channel name, description and unit can be seen.

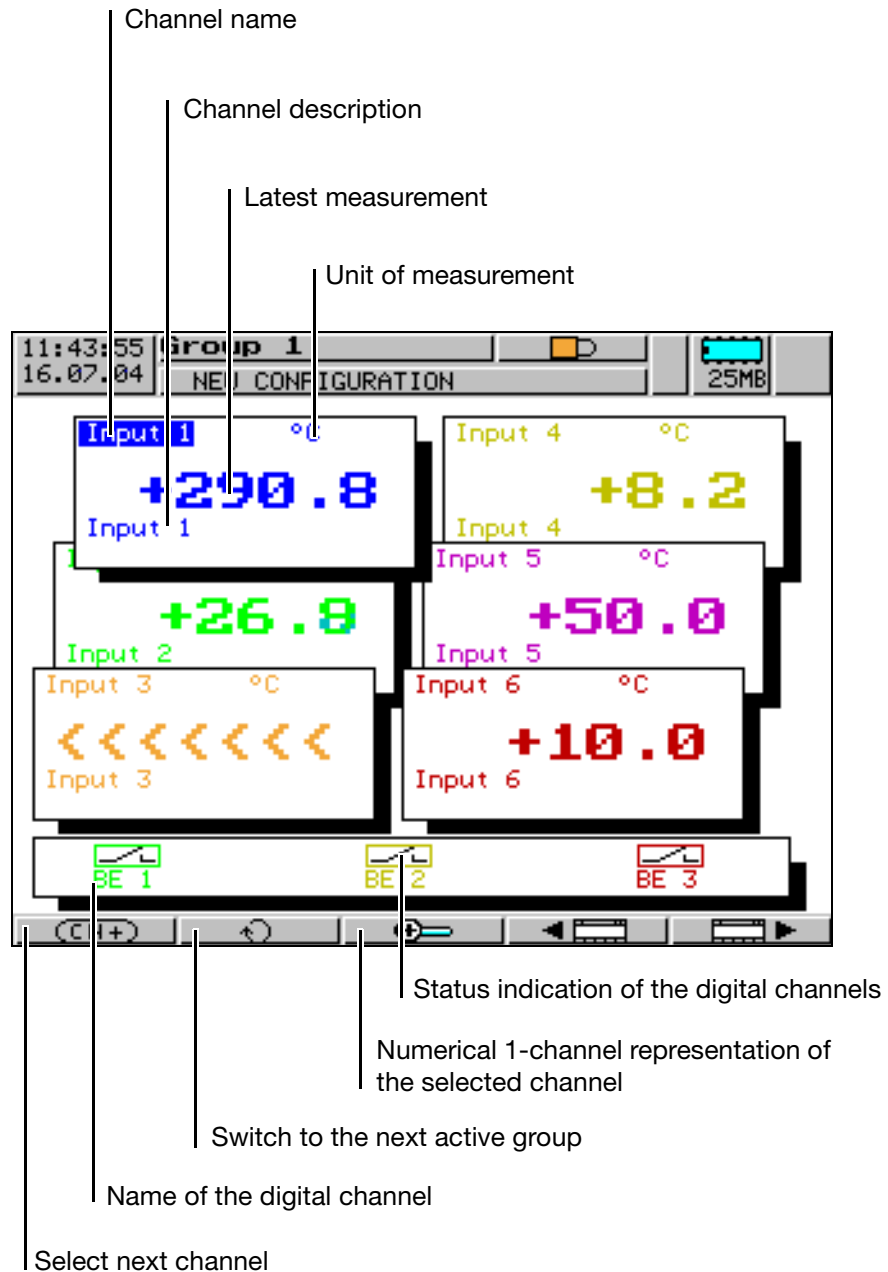

3 Operation and visualization

3.2.6 Numerical 1-channel representation

The numerical 1-channel representation is called up from the numerical representation, via the softkey .

In the numerical 1-channel representation, the latest measurement of a channel is shown in large letters both numerically and as a bar graph.

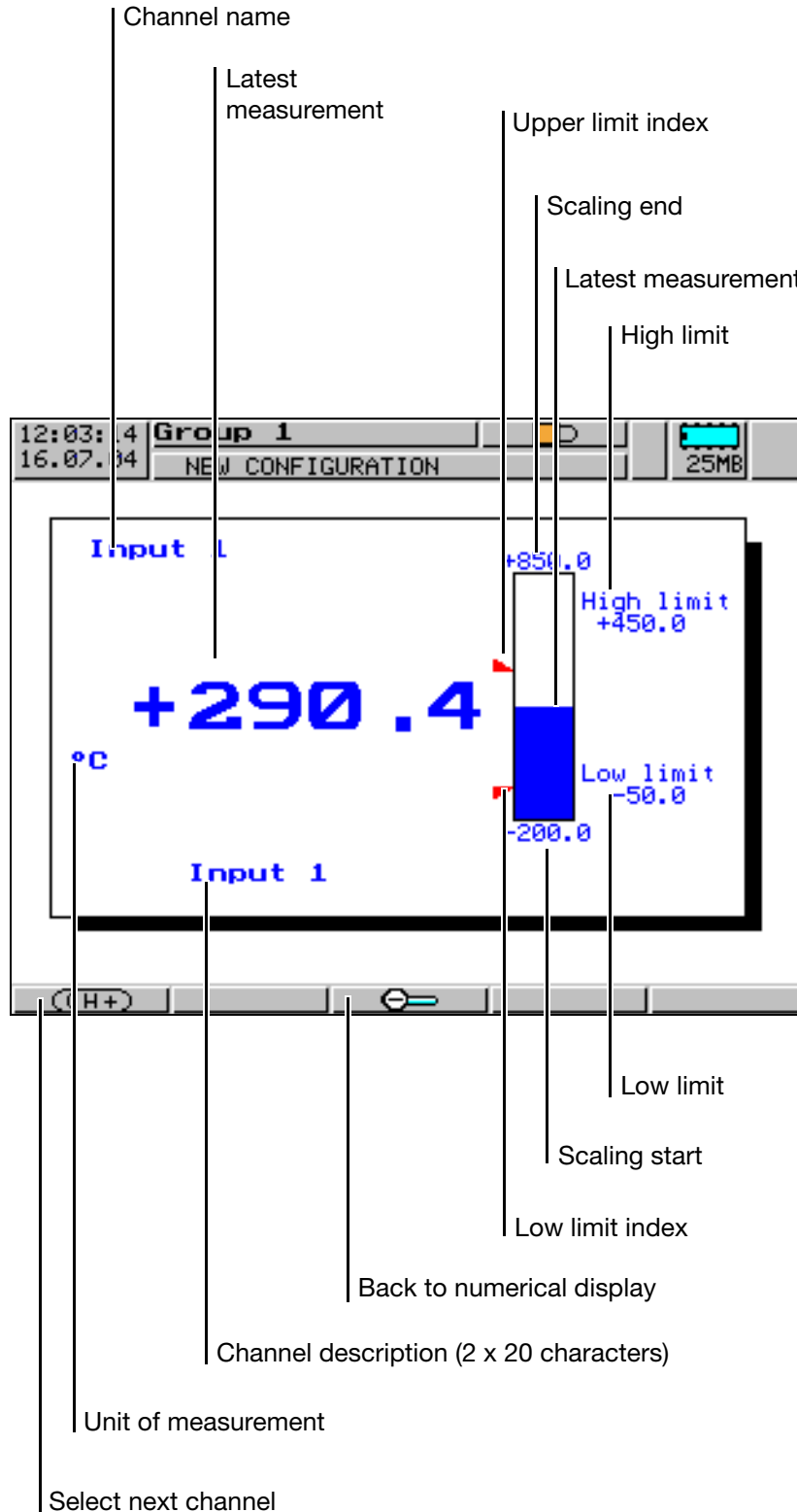

3 Operation and visualization

3.2.7 Reports

Definition A report is a set of statistics covering a specific period of time, which contains the minimum, maximum, average and, possibly, the integration value.

Types The recorder can run five different types of report:

- periodic report
(a report of a specific length of time, which is repeated periodically)
- external report/batches
(a report which is activated by a control signal, e. g. logic input, alarm, fault, memory alarm, ...).
- daily report
- monthly report
- annual report

Synchronization time All reports, apart from the external report, will be repeated according to a configurable synchronization time.

Current/completed report For each type of report, the currently running and the latest concluded report can be displayed.

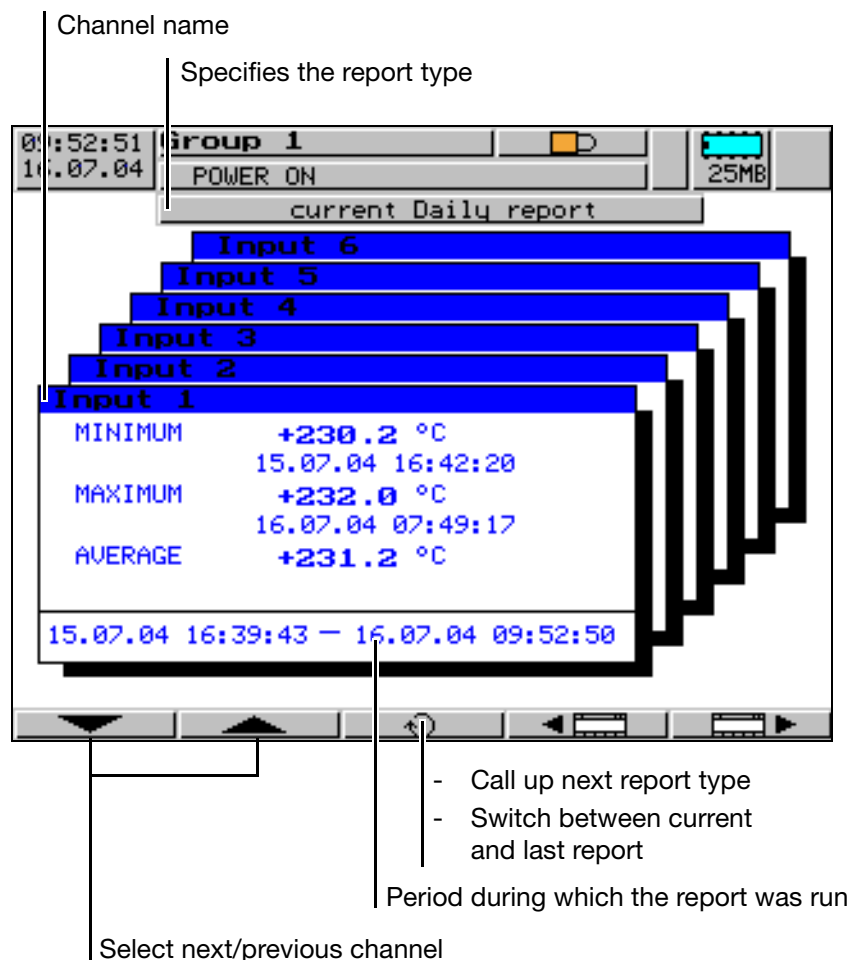

3 Operation and visualization

3.2.8 Batch reports

Batch reporting enables the creation of a flexible form to describe a batch process within the recorder. It can only be run parallel to an external report and is active when the parameter *Configuration* → *Report/Batches* → *Ext.Report/Batches* → *Status* has been configured to “E.R.+batches”.

Batch reporting (external report) can be controlled through one of the digital signals. The selection is made using the parameter *Configuration* → *Report/Batches* → *Ext.Report/Batches* → *Control signal*.

Two different screen representations are available for batch reporting:

- current batch report and
- completed batch report



The batch reporting function is described more fully on the following pages.

The batch report shown only serves as an example.

It can be adapted to match your specific requirements through reconfiguration.

Please note that, depending on the user, specific functions can be disabled through the PC Security Manager Software (PCS).

3 Operation and visualization

General

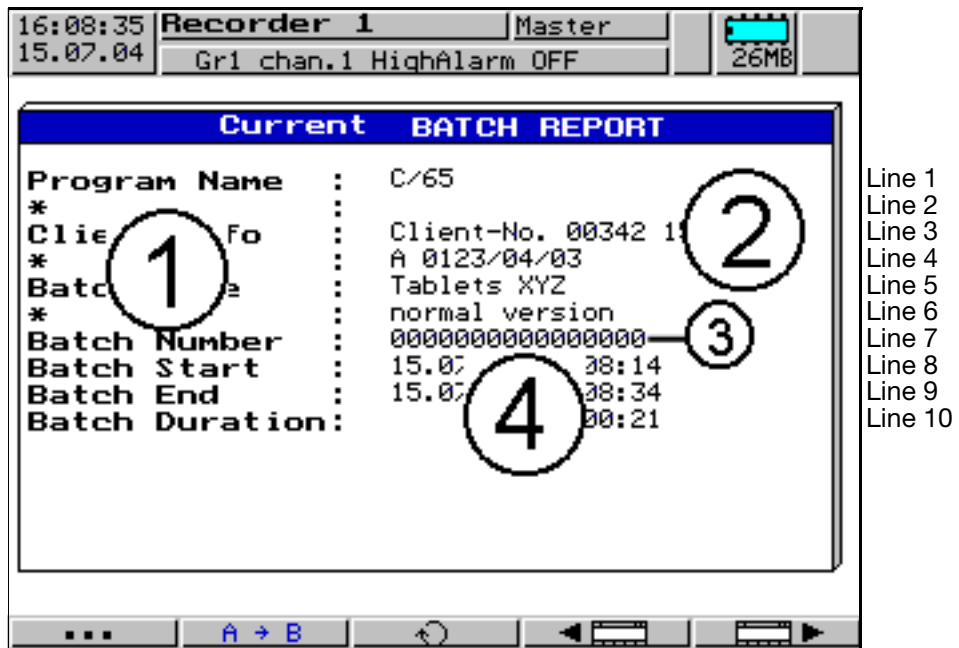

The screen arrangement is identical for both batch reports. It consists of 10 lines on the screen and 2 columns.

The left column “Text field (1)” contains text which describes the text in the right column “Text fields (2), (3) and (4)”. Text field (2) is used for “general batch texts”, text field (3) for the designation of the “batch number” and text field (4) defines the “time report”.

The table below describes by which means the individual text fields can be configured.

| Text field | Setup program | Text editor | automatic | Serial interface | Ethernet |
|------------|---------------|-------------|-----------|------------------|----------|
| (1) | yes | yes | | yes | yes |
| (2) | yes | yes | | yes | yes |
| (3) | | yes | yes | | |
| (4) | | | yes | | |



Each of the 10 lines is freely selectable and can be freely positioned.

3 Operation and visualization

Text field (1)

Text field (1) has to be set up before commissioning the system. Each line consists of a maximum of 15 characters.

Example: Parameter setting for line 1

| Parameter for line 1 | Parameter setting |
|--|-------------------|
| <i>Configuration → Report/Batches → Ext.Report/Batches → Batches → Line 1 → Text left column</i> | Program name |

Text field (2)

Text field (2) “Lines 1 – 6” was pre-assigned during recorder configuration, but can be overwritten as long as the batch is not completed. Each line can hold text with a maximum of 20 characters.



Example: Parameter setting for line 1

| Parameter for line 1 | Parameter setting |
|---|-------------------|
| <i>Configuration → Report/Batches → Ext.Report/Batches → Batches → Line 1 → Contents right column</i> | Fixed text |
| <i>Configuration → Report/Batches → Ext.Report/Batches → Batches → Line 1 → Default text</i> | C/65 |
| <i>Configuration → Report/Batches → Ext.Report/Batches → Batches → Line 1 → Text editable?</i> | Yes |

Using the text editor (button ), which is integrated in the recorder, the texts can be altered at a later stage, through the setting “Text editable = Yes”.

Example: Parameter setting for line 5

| Parameter for line 5 | Parameter setting |
|---|-------------------|
| <i>Configuration → Report/Batches → Ext.Report/Batches → Batches → Line 5 → Contents right column</i> | Text list |
| <i>Configuration → Report/Batches → Ext.Report/Batches → Batches → Line 5 → from text No.</i> | 90 |
| <i>Configuration → Report/Batches → Ext.Report/Batches → Batches → Line 5 → to text No.</i> | 91 |
| <i>Configuration → Report/Batches → Ext.Report/Batches → Batches → Line 5 → Text editable?</i> | Yes |
| <i>Configuration → Texts → Text 90</i> | Tablets XYZ |
| <i>Configuration → Texts → Text 91</i> | Tablets 123 |

The text in line 5 is selected from the internal text list of the recorder by calling up the button  followed by .

3 Operation and visualization

Example: Parameter setting for line 6

| | |
|---|--------------------|
| Parameter for line 6 | Parameter setting |
| <i>Configuration → Report/Batches → Ext.Report/Batches → Batches → Line 6 → Contents right column</i> | Binary-linked text |
| <i>Configuration → Report/Batches → Ext.Report/Batches → Batches → Line 6 → Binary linking</i> | Logic inp1-2 |
| <i>Configuration → Report/Batches → Ext.Report/Batches → Batches → Line 6 → from text No.</i> | 80 |
| <i>Configuration → Report/Batches → Ext.Report/Batches → Batches → Line 6 → Text editable?</i> | Yes |
| <i>Configuration → Texts → Text 80</i> | normal version |
| <i>Configuration → Texts → Text 81</i> | heavy version |
| <i>Configuration → Texts → Text 82</i> | plus version |
| <i>Configuration → Texts → Text 83</i> | plusC version |

The text in line 6 is selected from the internal text list of the recorder by linking the internal logic inputs.

| Parameter <i>Configuration ... Binary-linked texts</i> | Number of possible texts |
|---|--------------------------|
| Logic inp1-2 | 4 |
| Logic inp1-3 | 8 |
| Logic inp1-4 | 16 |
| Logic inp1-5 | 32 |
| Logic inp1-6 | 64 |

Text field (3)

Text field (3) (line 7) can be written to as long as the batch is not completed. The internal text editor (button ) can be used to input any number of up to 16 digits. After the batch has been completed, the batch number is automatically incremented.

Example: Parameter setting for line 7

| | |
|---|-------------------|
| Parameter for line 7 | Parameter setting |
| <i>Configuration → Report/Batches → Ext.Report/Batches → Batches → Line 7 → Contents right column</i> | Batch No. |

3 Operation and visualization

Text field (4)

Text field (4) is filled automatically by the recorder and cannot be altered.

Example: Parameter setting for line 8

| Parameter for line 8 | Parameter setting |
|---|-------------------|
| <i>Configuration → Report/Batches → Ext.Report/Batches → Batches → Line 8 → Contents right column</i> | Batch start |

Example: Parameter setting for line 9

| Parameter for line 9 | Parameter setting |
|---|-------------------|
| <i>Configuration → Report/Batches → Ext.Report/Batches → Batches → Line 9 → Contents right column</i> | Batch end |

Example: Parameter setting for line 10

| Parameter for line 10 | Parameter setting |
|--|-------------------|
| <i>Configuration → Report/Batches → Ext.Report/Batches → Batches → Line 10 → Contents right column</i> | Batch duration |

3 Operation and visualization

Batch texts

How can something be edited? Here is the summary again:

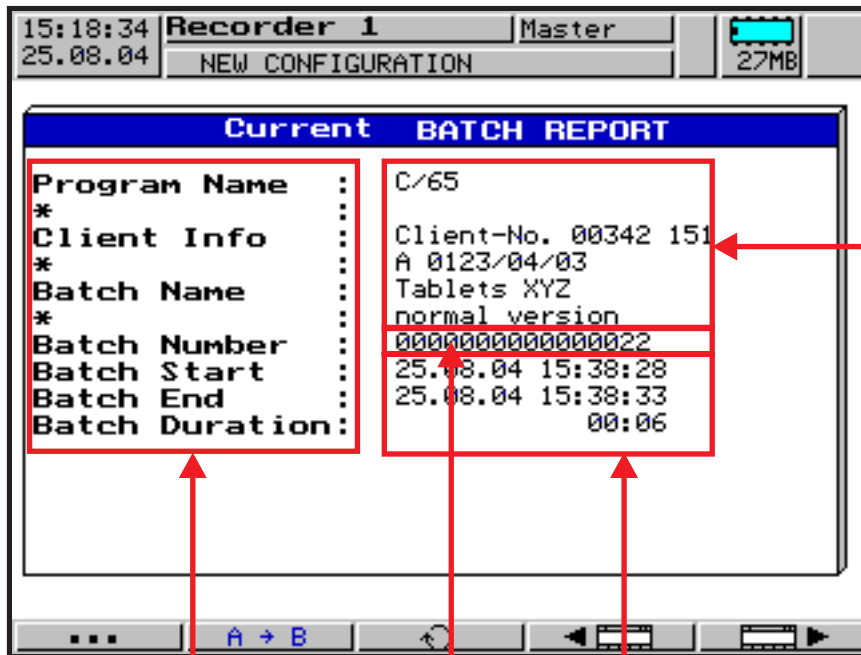

Texts can be edited on the instrument and by using the setup software. They can also be transferred online to an instrument, through the setup software.

Instrument:

- configuration
- report/batches
- ext. report/batches
- batches
- line 1 – 10
- default text

Instrument:¹

- visualization
- group 1 – 6
- current batch report
- press **A → B**
- place red bar
- press **A → B** again²
- edit

Setup software:

- report / batches
- ext. report / batches
- edit
- batch report

Setup software (online):

- make connection
- extras
- write interface texts³

Texts can be edited on the instrument and through the setup software.

Instrument:

- configuration
- report/batches
- ext. report/batches
- batches
- line 1 – 10
- text in left column

Setup software:

- report / batches
- ext. report / batches
- edit
- batch report

If batch start/end/duration are used, the lines cannot be edited.

The batch number can only be edited on the instrument.

1. Only available, if the batch parameter "Text editable?" is set to "Yes".

2. According to option, also or .

3. Each line has to be activated in the configuration for writing via interface.

3 Operation and visualization

Current batch report

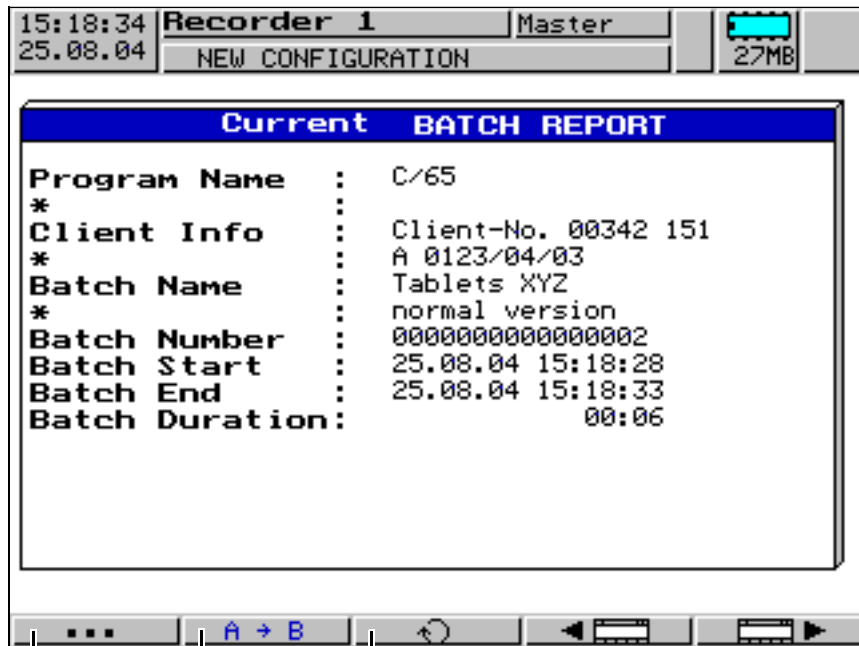

- Change to the previous/next visualization
- Change between "current" and last "completed" batch report
- Edit all editable parameters in the right column
- Switch the four right-hand softkeys to additional functions





- Show report data of batch report
- Show data of batch report as history in "horizontal diagram".
- Show data of batch report as history in "vertical diagram".
- Switch the four right-hand softkeys to original functions

3 Operation and visualization



Texts in the right column can only be edited here, in the current batch report.

After calling up the function, the field to be modified can be selected using the  and  buttons. How the field is modified, depends on the field type.







Activate the button to modify the field using the text editor.



Activate the button to select an entry from the text list.



Activate the button to modify the field using the , , , and  buttons.

The editing options are only displayed if the present field type allows it. Each entry is completed by pressing **[ENTER]**. **[EXIT]** cancels the editing procedure.

Example:
Editing the
batch
number

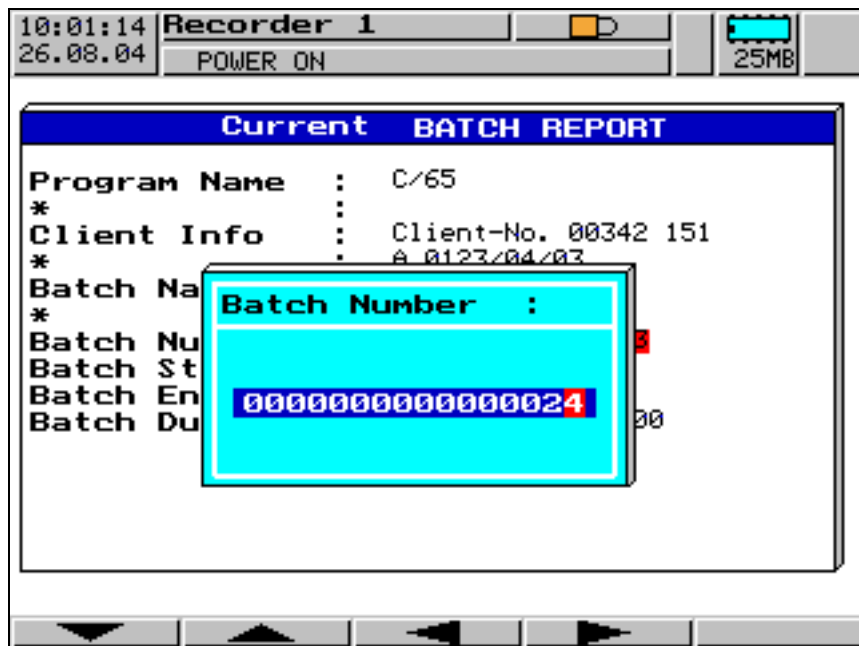

3 Operation and visualization

Completed batch report

The screenshot shows a completed batch report that does not include the possibility of executing an electronic signature.

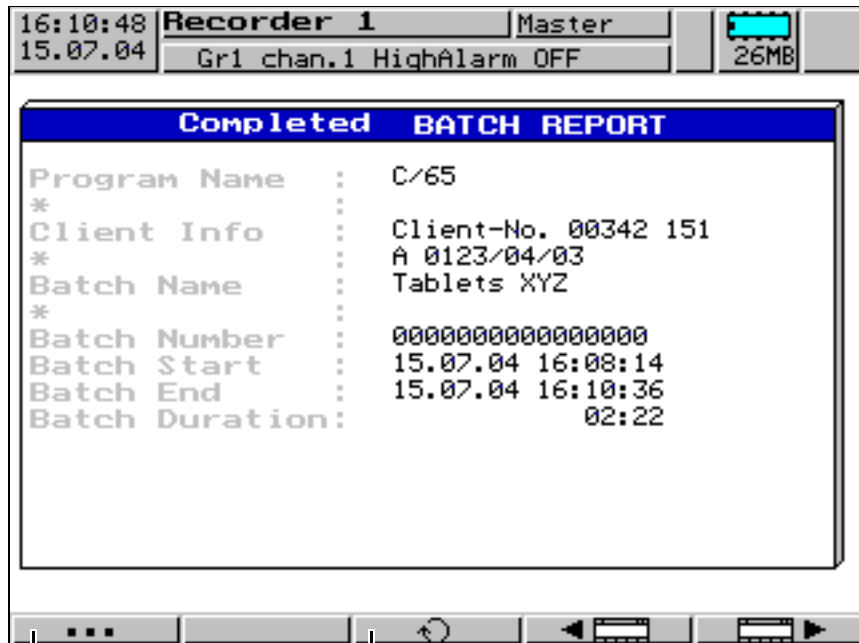

Change to the previous/next visualization

Change between "completed" and "current" batch report

Switch the four right-hand softkeys to additional functions



Show report data of batch report

Show data of batch report as history in "horizontal diagram".

Show data of batch report as history in "vertical diagram".

Switch the four right-hand softkeys to original functions

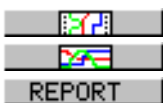

How to operate the "vertical" and "horizontal diagrams" is described in Chapter 3.2.3 "Evaluation of the stored measurement data".

Pressing the **EXIT** key will call up the batch report again.

3 Operation and visualization

Completed batch report

The screenshot shows a completed batch report that includes the possibility of executing an electronic signature.

Whether an electronic signature can be executed, is decided through the PC Security Manager Software (PCS).

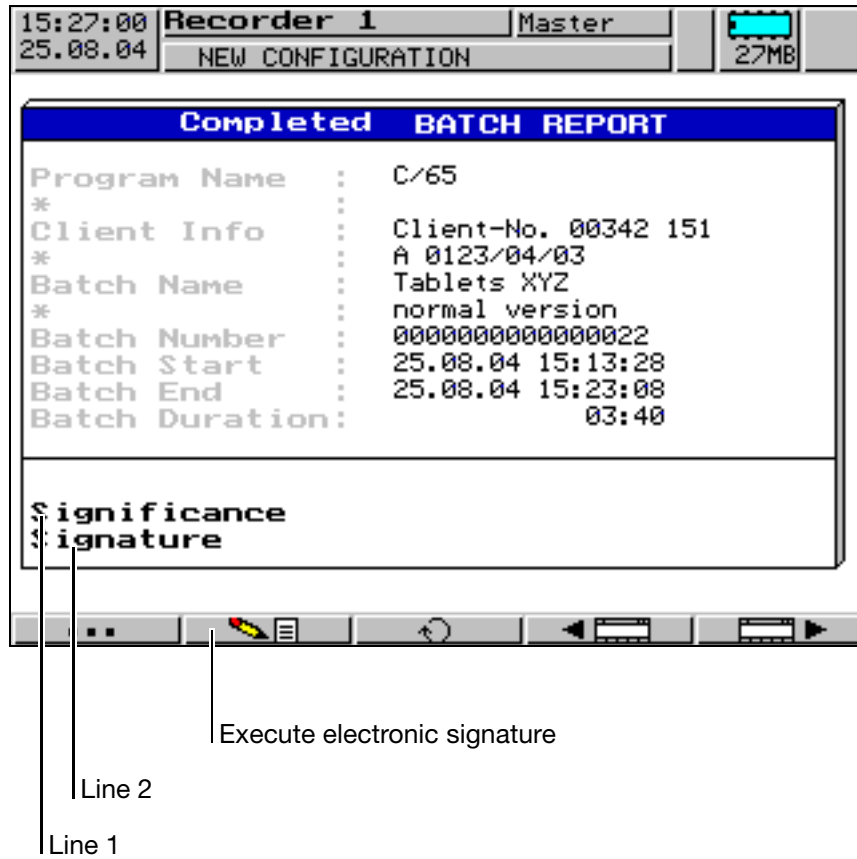

Executing the signature

The electronic signature is executed by calling up the  function.

Line 1

The text in the left-hand column is inserted in the *Configuration* menu, through the parameter *El. signature* → *Designation* → *Significance*.

The text in the right-hand column is inserted during signing, if, in the *Configuration* menu, the parameter *El. signature* → *Select significance* → *for batches* → *Text list?* has been set to "Yes". You can choose one from up to 146 texts. The contents of the 146 texts is set in the menu *Configuration* → *Texts*.

Line 2

The text in the left-hand column is inserted in the *Configuration* menu, through the parameter *El. signature* → *Designation* → *El. signature*.

After signing, the user name will appear in the right-hand column

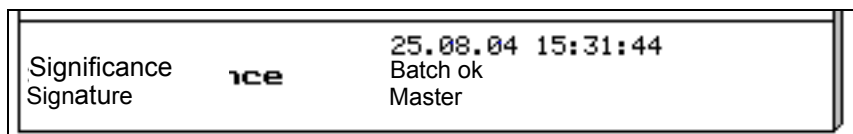

3 Operation and visualization

Signing batches at a later stage Only a completed batch protocol can be made visible and signed in the recorder. If you fail to sign, the electronic signature can be executed at a later stage in the PC Evaluation Software (PCA3000).

3.3 Parameterization







The following can be set at the parameter level:

- contrast,
- speed indication,
- memory indication,
- display off (screen saving),
- fine calibration and
- date and time



Functions which have been disabled using the PC Security Manager Software (PCS) cannot be called up. Which functions these are, can be different from user to user.



All parameter are selected using the  and  or  and  buttons.

3 Operation and visualization

Contrast The contrast of the screen can be set here. This ensures that the screen is always highly legible, even under difficult light conditions.

Speed indication Here, “time/div“ or “mm/h” can be selected for the speed display in the vertical and horizontal diagrams.

Example: a diagram speed of 1 h/div corresponds to 22mm/hr.

Memory indication You can determine the appearance of a part of the status line here.

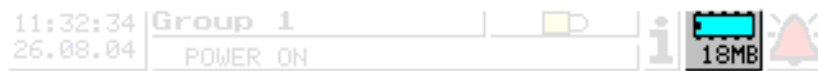

The following symbols can be set:



Memory indication → CF card (external) = always

or

Memory indication → CF card (external) = if inserted

If “CF card (external)” is not set to “always”, there is a further parameter:



Memory indication → Internal memory: for = read-out via CF

or

Memory indication → Internal memory: for = ser. read-out



⇒ Chapter 2.2 “Operating principle and graphic elements”

Display off (screen saving)

Display off → Switch-off event = waiting time

For screen saving, a time between 0 and 32767min can be set here. If no key on the recorder is operated during this time, then the screen goes dark. If 0min is set, then screen saving is deactivated.

Display off → Switch-off event = control signal

Display switch-off is initiated by one of the digital signals.



The power LED blinks during screen saving.

3 Operation and visualization

Fine calibration Using fine calibration, the analog measurements can be calibrated (adjusted). The adjustment is carried out using a linear equation. After selecting the channel, first set the parameter *Fine calibration* → *Calibration status* = ON, then enter the parameters for fine calibration.

| | |
|---------------------------|--------------------------------|
| <i>Actual start value</i> | Start value of the actual line |
| <i>Target start value</i> | Start value of the target line |
| <i>Actual end value</i> | End value of actual line |
| <i>Target end value</i> | End value of target line |

Systematic errors, such as those caused by an unsuitable probe mounting, for example, can be compensated through fine calibration.

Example:

A probe provides measurements that cover a temperature range from 200 to 300 °C. It has been installed in a tunnel oven so unfavorably as to always indicate 10°C less than the temperature of the charge. The incorrect measurement can be corrected through fine calibration.

| | |
|--------------------|---------|
| Actual start value | : 200°C |
| Target start value | : 210°C |
| Actual end value | : 300°C |
| Target end value | : 310°C |



Performing a fine calibration is handled in the same way as altering the configuration. After fine calibration, the recorder can be reset.

Date and time

Here you can set the internal clock of the recorder.



Setting the date and time is treated in the same way as altering the configuration. After setting the date or the time, the recorder is reset.

3 Operation and visualization

3.4 Configuration

The configuration level can only be called up if the user who is logged in has the right to do so. The rights are administered with the PC Security Manager Software (PCS).

Window technology

As for the other levels, the principle of configuration is also based on menu-led window technology. Individual menu items can be selected in the windows. The window title describes the contents of the window.

When a menu item has been selected, a further window with new menu items is opened, until the required parameter is finally reached. If several windows are open, the window title assists in orientation.

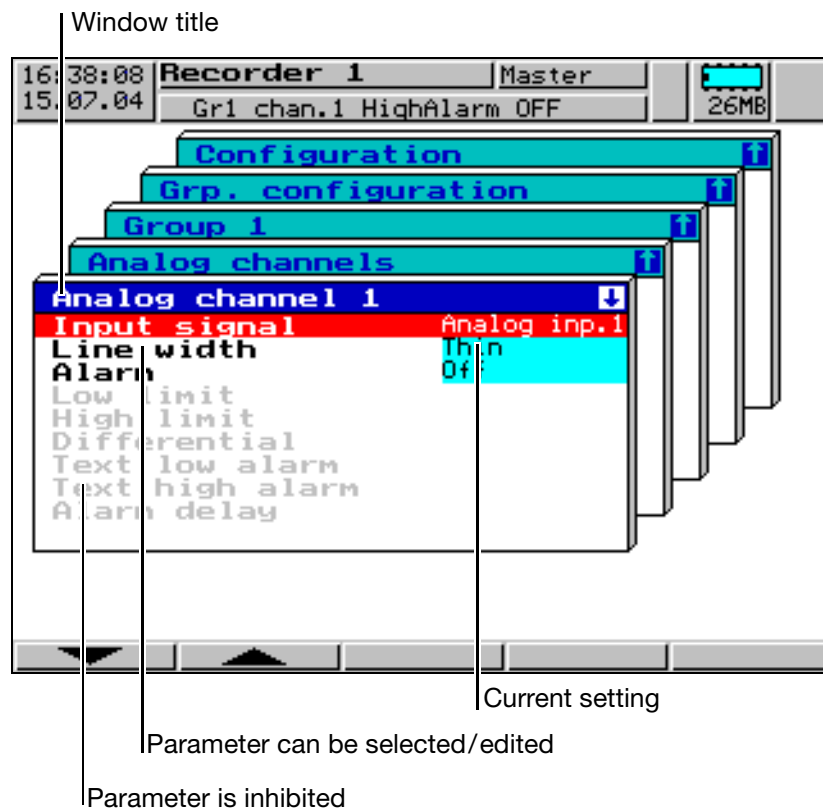

The configuration of the recorder is sub-divided into the following levels:

- device data,
- analog inputs,
- digital signal name,
- group configuration,
- outputs,
- control functions,
- report / batches
- electronic signature,
- texts and
- interfaces.

3.5 Event list / AT

The following tabular lists are concealed behind the menu item:

- event list and
- audit trail list.

Different events can initiate texts in the recorder, which are included in the event list. Special events that are important as far as compliance with FDA regulations is concerned (e.g. registration of operator actions) are stored in the audit trail list. The audit trail list can only be called up if the user who is logged in has the right to do so. The rights are administered with the PC Security Manager Software (PCS).

Both lists are stored in the RAM and on the CompactFlash memory card.

3.5.1 Event list

Events may include:

- alarms triggered by out-of-limit conditions on individual channels,
- external texts triggered through logic inputs,
- message texts received via the serial interface,
- system messages (e.g. power ON/OFF, summer/winter time changeover),
- incrementing/decrementing of an (event) counter (usually triggered through a logic input).

Event definition

For all events, except for system messages, it is possible to configure whether:

- the message text is to be included in the event list,
- the instrument-internal standard text
- or one of the texts (see below) is used.

Text assignment

The texts (standard texts which include 146 freely definable texts) are assigned to events at the operating level "Configuration".

3 Operation and visualization

Standard texts The recorder offers standard texts as listed in the following table:

| Standard text | Comment |
|--|--|
| Grx Chan y low alarm ON Grx Chan y low alarm OFF Grx Chan y high alarm ON Grx Chan y high alarm OFF Logic input x ON Logic input x OFF Ext. input x ON Ext. input x OFF | x = group number y = channel number |
| Power ON Power OFF Data lost Summer time start Summer time end New configuration | |
| Counter 1: +xxxxx Counter 2: +xxxxx | 5 digits plus sign, no decimal point |

Freely definable texts 146 texts belonging to the group of standard texts can be freely defined, up to a length of 20 characters.

| Standard text | Comment |
|---|--|
| “Text 1 – 146” In the case of logic signals and alarms, the supplementary text “ON” or “OFF” is added automatically, on counters the current count is added. | 146 freely definable texts with 20 characters each |

Supplementary text The recorder automatically supplements the texts by “ON” or “OFF” in order to distinguish between the appearance and disappearance of the signal.

Example:

| Standard text | Supplementary text | Entry in event list |
|---------------|--------------------|---------------------|
| Logic input 2 | ON | Logic input 2 ON |
| Logic input 2 | OFF | Logic input 2 OFF |

Interface text A text of up to 20 characters length can be entered in the event list via the serial interface. For further information, please refer to the Interface Description B 70.6560.2.0.

3 Operation and visualization

Start menu→
Event list

The event list is called up via the start menu:

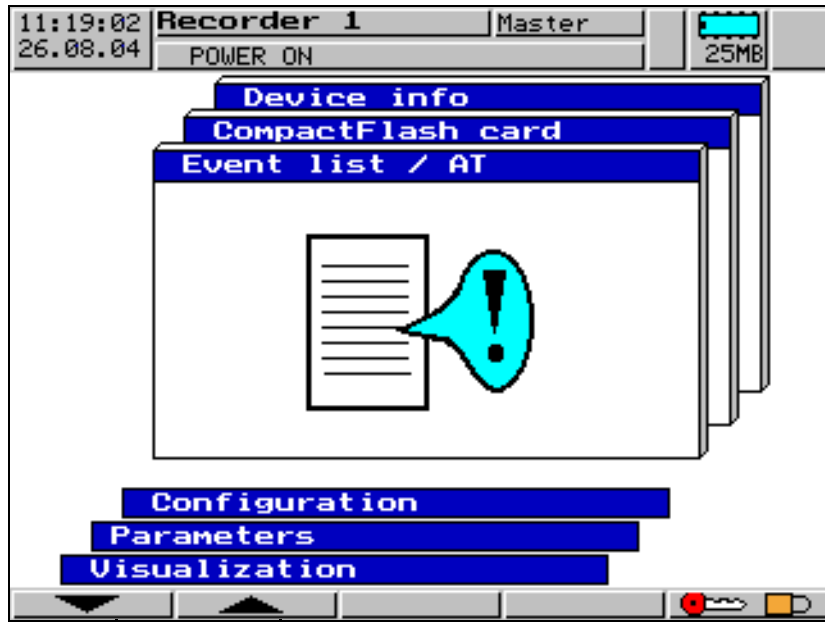

- * Select operating level *Event list*
- * Enter selection with

Event list

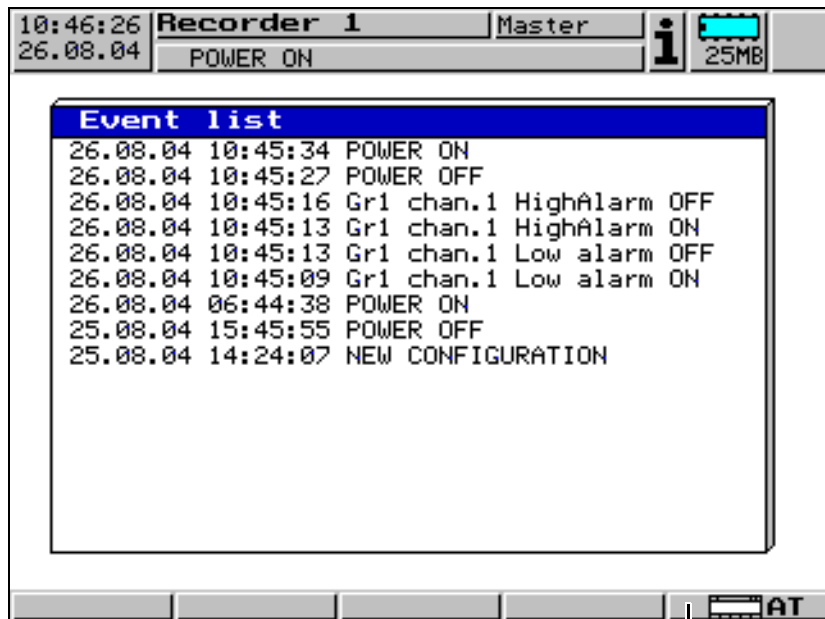

Call up audit trail list

3 Operation and visualization

3.5.2 Audit trail list

Starting from the event list, call up the audit trail list using the  button.

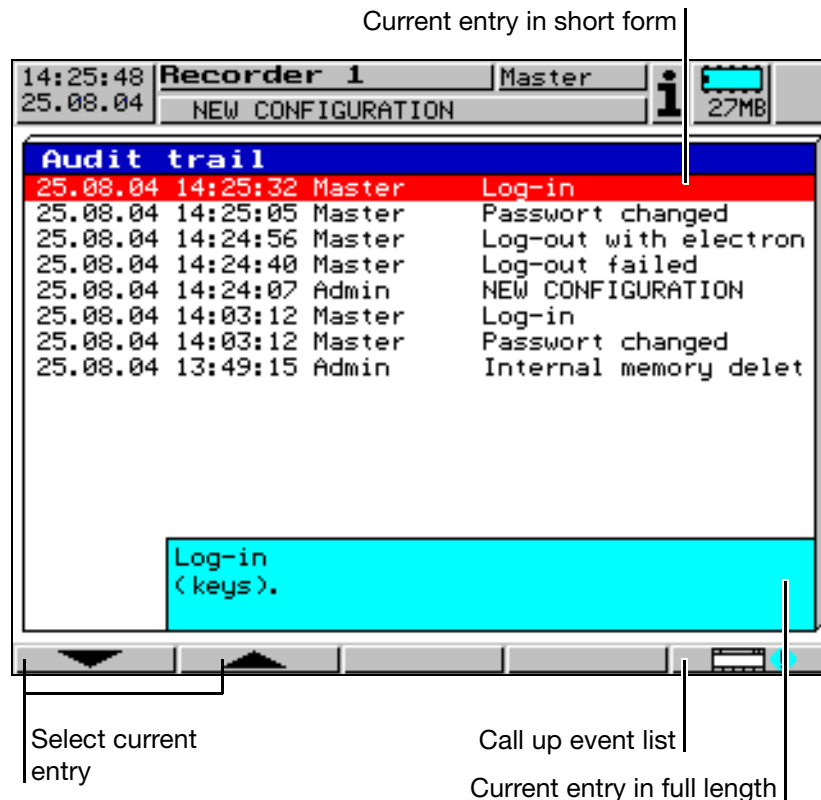

The following are entered in the audit trail list:

- each operator intervention with time stamp, name, ID, alteration (reason for alteration). An operator intervention is any alteration of the system resulting in an alteration of process data, configuration data, or in the audit trail,
- electronic signing,
- configuration alterations,
- fine calibration,
- successful or failed log-in or log-out attempts,
- alteration of user rights and password changes,
- CompactFlash memory card was removed or inserted,
- process data transfer via interface (start, stop),
- manual time change on the recorder or through the setup software,
- time synchronization,
- removing the back panel cover and
- power ON or power OFF.

3 Operation and visualization

3.6 CompactFlash card

The CompactFlash card¹ menu can only be called up if the user who is logged in has the right to do so. The rights are administered using the PC Security Manager Software (PCS).

Automatic storage of measurement data

The data stored in the paperless recorder are automatically saved to the CompactFlash memory card at regular intervals. The PC Evaluation Software reads the data off the memory card and provides convenient functions for evaluation.

The data stored on the external CompactFlash memory card and in the recorder are not deleted when the configuration is altered.

⇒ Additional information about the PC Evaluation Software (PCA3000) can be found in the Operating Manual B 70.9701.0.

Loading and saving the configuration data

The configuration data can be downloaded from the CompactFlash memory card and saved to the CompactFlash memory card. In addition, this makes it possible to copy a configuration from one instrument to another (or to transmit it from/to the setup software).

A configuration data file can be stored on the CompactFlash memory card. Measurement data or other data already stored on the CompactFlash memory card will not be overwritten during storing.

Start menu→ CompactFlash card

The menu is called up via the start menu:



- * Select operating level *CompactFlash card*
- * Enter selection with **ENTER**

1. PC Card access made available by CSM FAT File System
Copyright © 1997-2002 CSM GmbH Filderstadt, Germany

3 Operation and visualization

CompactFlash card

Measurement data not yet saved are written to the CompactFlash memory card.

All running reports are concluded and written to the CompactFlash memory card, together with the measurement data not yet saved.

All measurement data in the memory (also those which have already been fetched) are written to the CompactFlash memory card.

The configuration data are written to the CompactFlash memory card.

The configuration data are read in from the CompactFlash memory card. The recorder will thus be freshly configured.

The user list is read in from the CompactFlash memory card.

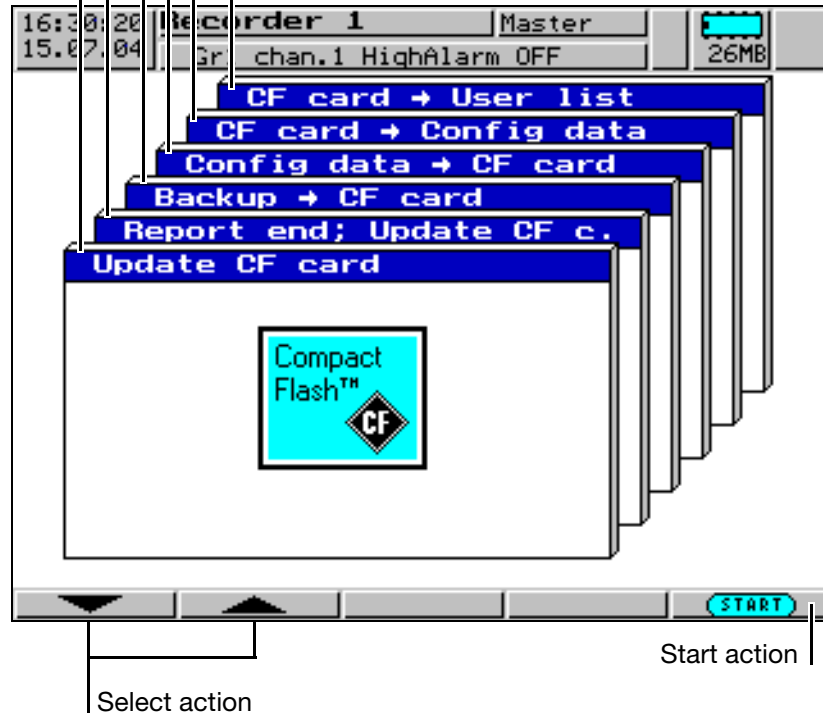

The function *Update -> CF card* reads out data that have not yet been read out. After read-out, the data are marked as read in the recorder.

The function *Backup -> CF card* reads out all the data of the internal memory, also those that have already been read out. After read-out, the data are **not** marked as read in the recorder. This means that they remain available for the function *CF card -> Update*. The function *Backup -> CF card* is therefore ideal for test and maintenance purposes.

3 Operation and visualization

Status messages

Status messages of the CompactFlash card menu are shown in a separate window in the menu.

- If you use the **EXIT** key to confirm a message, the CompactFlash menu is automatically terminated.
- If you use the **ENTER** key to confirm a message, only the message is deleted, the CompactFlash menu continues to be active.

The following status messages are possible:

| Status message | Description |
|---|--|
| Action successfully completed. | Directly before removing the CompactFlash card from the instrument, it is necessary to call up <i>Update CF card</i> so that all measurement data up to the time of removal are contained on the CompactFlash card. The data not yet stored since the last automatic saving are written. |
| Action canceled. | This message is shown when accessing the CompactFlash card has been canceled by activating the Esc button. |
| No card in disk drive! | Access to the CompactFlash card was attempted, even though there is none in the instrument. |
| Not enough memory available on card! | The CompactFlash card is full. No more data are written. Remedy: Insert a blank CompactFlash card before the measurement data memory of the recorder is also full. If this is not done, measurement data will be lost. |
| Card is write-protected! | The inserted CompactFlash card cannot be written to because it is write-protected. |
| Card is not DOS-formatted! | An error has occurred while writing to the CompactFlash card, because it was wrongly formatted or not formatted at all. Remedy: Format the CompactFlash card. |
| General error! | An error has occurred while writing to the CompactFlash card. The CompactFlash card may be faulty. Remedy: Insert new (DOS-formatted) CompactFlash card. |
| No config. data on the CompactFlash card found! | You start the function <i>CF card</i> → <i>Config. data</i> and there are no configuration data on the CompactFlash card. Remedy: Check card on PC and generate data again, if necessary. |
| No user list on the CompactFlash card found! | You start the function <i>CF card</i> → <i>User list</i> and there is no user list on the CompactFlash card. Remedy: Check card on PC and generate list again, if necessary. |

3 Operation and visualization

| Status message | Description |
|---------------------------------|--|
| The user list was not accepted! | You start the function <i>CF card</i> → <i>User list</i> , but the user list could not be accepted for unknown reasons. Remedy: Check card on PC and generate list again, if necessary. |
| Card is faulty! | The CompactFlash card does not respond. It is probably faulty. Remedy: Reformat card, or use a new one. |

3 Operation and visualization

3.7 Device info



The device info window displays general information about the instrument. It also includes the errors “Battery empty” and “Data lost”. If one of these instrument errors occur, the info symbol flashes in the status line.

Start menu→
Device info

The device info is called up from the start menu:



- * Select operating level *Device info*
- * Enter selection with

Device info

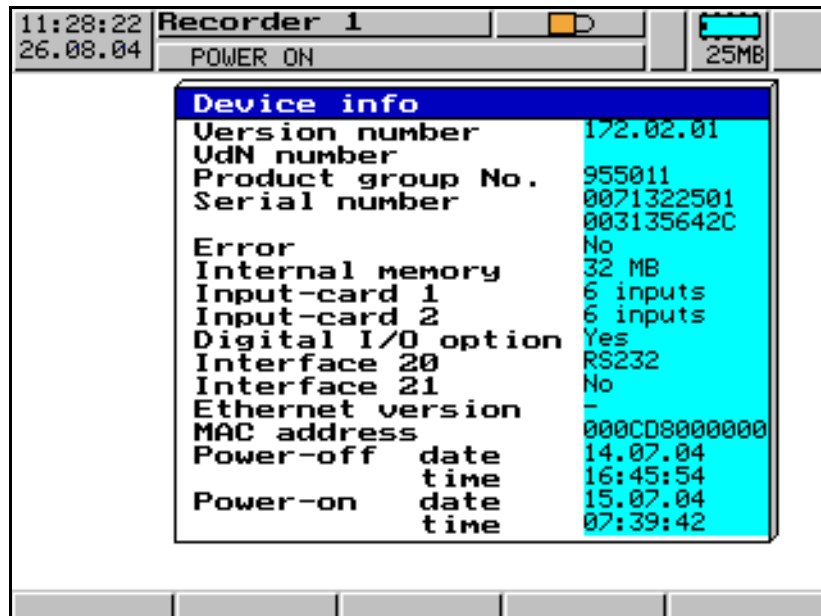

3 Operation and visualization

Error

The following errors may occur:

| Error | Description |
|-----------|---|
| none | Instrument OK |
| Data lost | <p>A discharge of the lithium battery/storage capacitor occurred during the last lengthy power interruption.</p> <p>Consequently, the measurement data stored up to now in the SRAM only will be lost. The data in the internal backup memory will be retained. The clock is set to 01.01.97, 00:00:00 hrs.</p> <p>Remedy: For instruments with storage capacitor: reset the time. For instruments with lithium battery: return instrument to the supplier for a change of battery.</p> |
| Battery ↓ | <p>The lithium battery is discharged.</p> <p>Remedy: Return instrument to the supplier for a change of battery.</p> |



Data may be lost after disconnecting the instrument from the supply: after more than > 4 years on instruments with a lithium battery, and after approx. > 2 days (ambient temperature 15 – 25°C) with storage capacitor.

3 Operation and visualization

3.8 Text entry

Entry options The configurable texts can be entered either through the setup program or on the instrument itself. This section describes the entry on the instrument.

Character selection The screen below is shown when a text (e.g. *Configuration* → *Group config.* → *Group 1* → *Group name*) has been selected at the configuration level for editing using **[ENTER]**.

You are automatically in the editing mode.

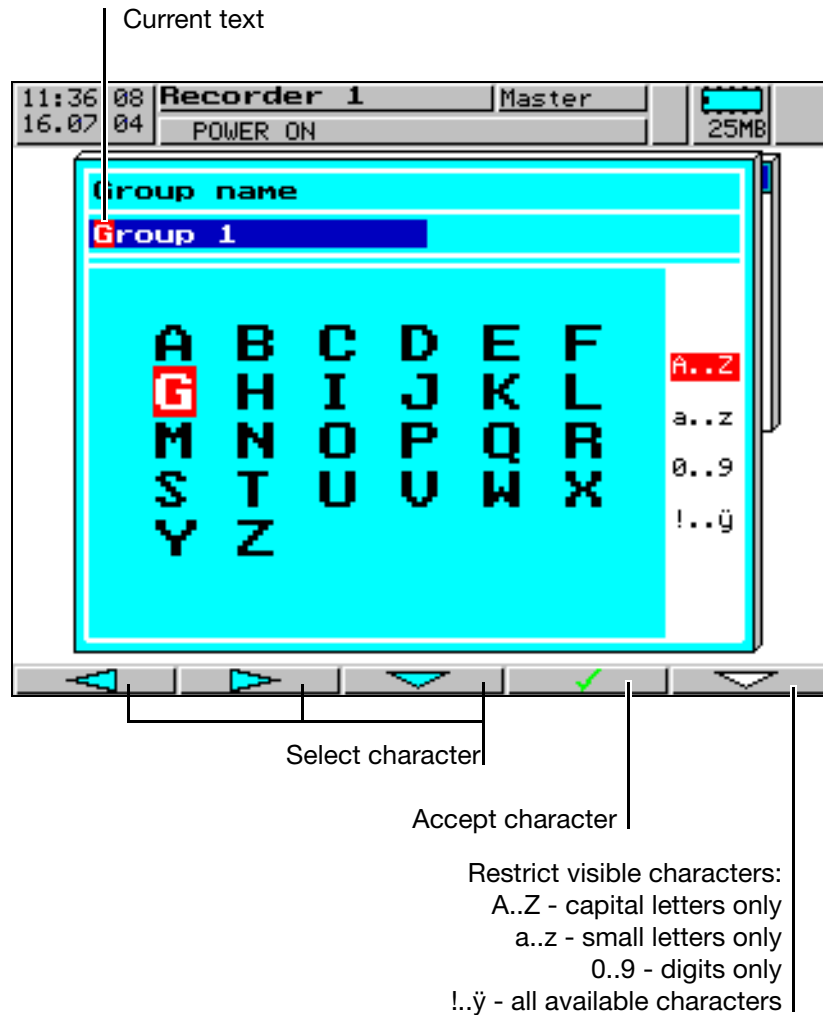

Character entry Select the required character (the required digit) using the  buttons and confirm entry with .

After the entire text has been entered, it can either be accepted or all alterations canceled.

* Enter text with **[ENTER]**

or

* cancel text entry with **[EXIT]**

3 Operation and visualization

Character restriction

Using the  button, you can restrict the number of visible characters. The fewer characters are displayed, the easier the selection.

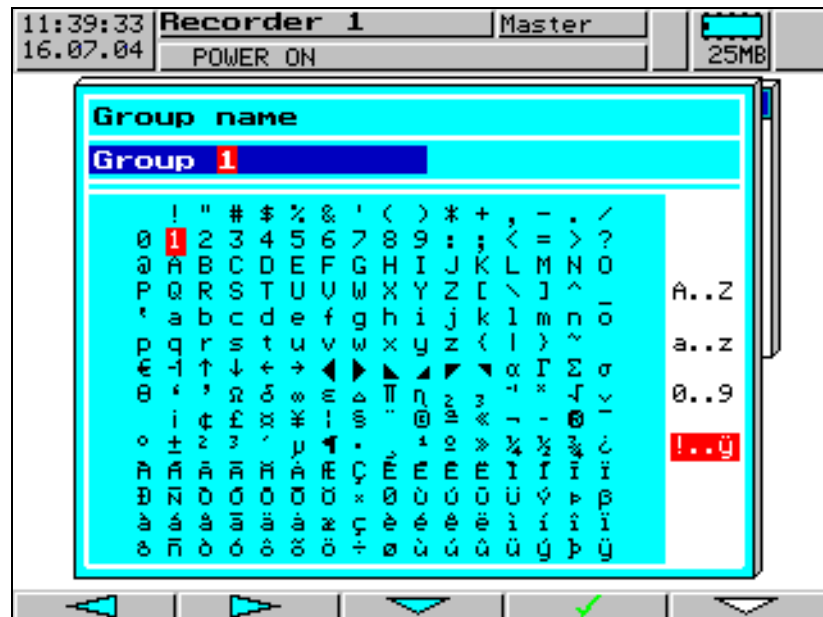
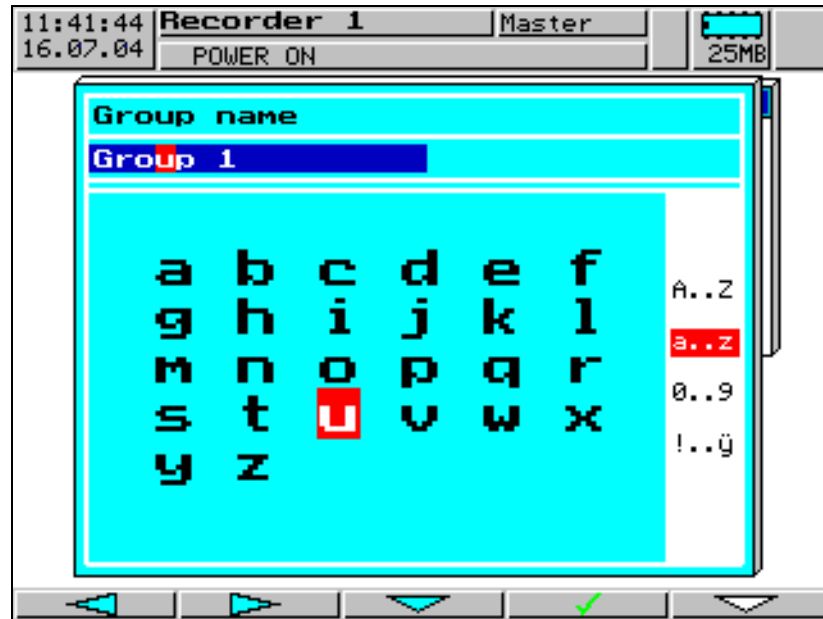

A

Alarm 15
Annual report 32
Arrangement of the documentation 6
Audit trail 47

B

Bar graph representation 29
Batch report
 Completed batch report 41–42
 Current batch report 39
 Executing the signature 42
 Signing batches at a later stage 43
Batch reports 33
Batch texts 38
Batches 32

C

Channel description 30–31
Channel line 12, 15
Channel name 30–31
Character entry 57
Character restriction 58
Character selection 57
Color display 11
Commissioning 5
CompactFlash 7, 11–12, 15
CompactFlash card 51
Continue search 28
Contrast 43–44
Counters 47

D

Daily report 32
Date 43
Diagram speed 24–25
Display 11
Display off 12, 43
Displays and controls 11

E

Electrostatic discharge (ESD) 5
Enter key 11, 13
Error 56
Error messages 56

4 Index

Evaluation of measurement data 25–26
Evaluation software 51
Event definition 47
Event list 47
Event message 14
Events 47
Exit key 11, 13, 18
External report 32

F

Falling below range 15
Fine calibration 43, 45

G

Group manager 23
Group or instrument (device) name 14

H

High limit 31
History 26, 39, 41
Horizontal diagram 25
Horizontal diagram representation 25

I

Information 14
Instrument (device) info 55
Instrument documentation in printed form 6
Instrument documentation in the form of PDF files 6
Introduction 5

K

Keys 10, 14

L

Limit index 24
Logged-in user 20
Logging in 20
Logging in/out 18–19
Logging out 21
Low limit 31

M

Memory display 43–44
Menu key 11, 13, 18
Monthly report 32

N

No value found 28
Note signs 9
Numerical 1-channel representation 31
Numerical representation 30

O

Out of limit 29

P

Parameterization 43
Password 22
Password alteration 22
Periodic report 32
Power LED 11, 13
Principle of configuration 46
Product description 6

R

Report 32
Representation 10
Returning 5

S

Sales documentation in printed form 6
Scaling 24
Screen saving 12, 43
Screen texts 10
Search result 28
Setup plug 12
Simplified password entry 20
Softkey 11–14, 20, 26
Speed 24–25
Speed indication 43–44
Stainless steel front 13
Standard text 48
Start menu 18
Status indication of the digital channels 30

4 Index

Status LED *11, 13*
Status line *12, 14*
Status message *53*
Supplementary text *48*
Synchronization time *32*

T

Text entry *57*
Texts *48*
Time *43*
Time & Date *14*
Typographical conventions *9*

U

Underrange *15*
Unit of measurement *24*
User
 Logged-in user *14*
 Signing a batch *42*
 Standard (default) password *19*
 Standard (default) user *19*

V

Value found *28*
Vertical diagram representation *24*
Visualization *23*

W

Warning signs *9*
Warranty *5*
White Paper *6*
Window technology *46*
Writing configuration data to CF card / reading from CF card *52*

Z

Zoom *27*



JUMO GmbH & Co. KG

Street address:
Moltkestraße 13 - 31
36039 Fulda, Germany
Delivery address:
Mackenrodtstraße 14
36039 Fulda, Germany
Postal address:
36035 Fulda, Germany
Phone: +49 661 6003-0
Fax: +49 661 6003-607
e-mail: mail@jumo.net
Internet: www.jumo.net

JUMO Instrument Co. Ltd.

JUMO House
Temple Bank, Riverway
Harlow, Essex CM20 2TT, UK
Phone: +44 1279 635533
Fax: +44 1279 635262
e-mail: sales@jumo.co.uk
Internet: www.jumo.co.uk

JUMO Process Control, Inc.

8 Technology Boulevard
Canastota, NY 13032, USA
Phone: 315-697-JUMO
1-800-554-JUMO
Fax: 315-697-5867
e-mail: info@jumo.us
Internet: www.jumo.us