

JUMO hydroTRANS H50

Humidity and Temperature Sensor
for High Humidity and Chemically Polluted Conditions



Operating Manual

907055



V1.00/EN/2025-03-03

Content

1	General Information	4
1.1	Explanation of Warning Notices and Symbols	4
1.2	Safety Instructions	5
1.2.1.	General Safety Instructions	5
1.2.2.	Alarm Module with Voltages >50 V (Additional Module Option 2)	5
1.2.3.	Integrated power supply 100 - 240 V AC (Additional Module Option 3)	5
1.2.4.	Intended Use	5
1.2.5.	Mounting, Start-up and Operation	6
1.3	Environmental Aspects	7
1.4	ESD Protection	7
2	Scope of Supply	7
3	Product Description	8
3.1	General	8
3.2	Product Design	8
3.3	Configuration Interface	9
3.4	Operation and Heating Modes	10
3.4.1.	Overview Operation Modes and Types	10
3.4.2.	Automatic ReCover (ARC) against Chemical Pollution	10
3.4.3.	Condensation Guard (CG) against Temporary Condensation	12
3.4.4.	High Humidity Guard (H ² G) against Continuous High Humidity and Condensing Conditions	13
3.5	Optional Features	13
3.5.1.	TFT Colour Display	13
3.5.2.	Smart Probe (Probe Connection Option 7)	15
3.5.3.	ARC Module (Additional Module Option 1)	16
3.5.4.	Alarm Module (Additional Module Option 2)	17
3.5.5.	Integrated Power Supply 100 - 240 V AC (Additional Module Option 3)	19
3.5.6.	RS485 Module - Modbus RTU (Digital Interface Option 3)	20
3.5.7.	Ethernet Module - Modbus TCP (Digital Interface Option 4)	20
3.6	Dimensions	22
4	Mounting and Installation	23
4.1	Sensor Enclosure	23
4.2	General Information for Mounting hydroTRANS H50 Sensing Probes	24
4.3	Remote Sensing Probe Type 10	24
4.4	Remote Sensing Probe Type 20	25
4.4.1.	Installation of the Probe directly in the Process	25
4.4.2.	Installation of the Probe with Ball Valve Set	26
4.5	Remote Sensing Probe Type 30	27
4.6	Remote Sensing Probes Type 40	28
4.6.1.	Installation at Normal Pressure	29
4.6.2.	Pressure-tight Installation	29
5	Electrical Connection	29
5.1	Electrical Connection and Wiring Overview	30
5.2	With Cable Glands	33
5.3	Plug Options	33
5.4	ARC Module (Additional Module Option 1)	33
5.5	Alarm Module (Additional Module Option 2)	33
5.6	Integrated Power Supply 100 - 240 V AC (Additional Module Option 3)	34

6	Setup and Configuration	35
6.1	PCS Configuration Software	35
6.1.1.	General	35
6.1.2.	Analogue Outputs.....	35
6.1.3.	Simulation Mode.....	36
6.1.4.	Multipoint Adjustment	36
6.1.5.	Eventlog and Histograms.....	36
6.2	RS485 Digital Interface	36
6.2.1.	Modbus RTU Setup	36
6.2.2.	Modbus Register Map	38
6.2.3.	Freely Configurable Custom Modbus Map.....	39
6.2.4.	Device Status Indication	40
6.2.5.	Module Status Indication	41
6.2.6.	Device Operating Conditions Indication.....	41
6.2.7.	Retrofit with RS485 Module.....	42
6.3	Modbus RTU Example	42
7	Maintenance and Service	43
7.1	Self Diagnosis and Error Messages	43
7.1.1.	Error Messages on the Display.....	43
7.1.2.	Status and Error Messages via LEDs	43
7.2	Cleaning the Sensing Head and Filter Cap Replacement.....	44
7.3	Automatic ReCovery (ARC)	44
7.4	RH and T Calibration and Adjustment	44
7.4.1.	RH and T Adjustment and Calibration for Types 10 / 20 / 30.....	45
7.4.2.	RH and T Adjustment and Calibration for Probe Type 40.....	46
7.5	Fuse Replacement for Integrated Power Supply 100 - 240 V AC (Additional Module Option 3).....	46
8	Ordering Guide hydroTRANS H50 Smart Probe	47
9	Technical Data	47
10	Conformity	50
10.1	Declarations of Conformity.....	50
10.2	FCC Part 15 Compliance Statement	50
10.3	ICES-003 Compliance Statement.....	50
11	Appendix: Display Menu Structure.....	51
11.1	Overview.....	51
11.2	Detailed Information.....	51
11.3	Optional Menus.....	55

1 General Information

This user manual serves for ensuring proper handling and optimal functioning of the device. The user manual shall be read before commissioning the equipment and it shall be provided to all staff involved in transport, installation, operation, maintenance and repair. JUMO GmbH & Co. KG does not accept warranty and liability claims neither upon this publication nor in case of improper treatment of the described products.

All information, technical data and diagrams included in this document are based on the information available at the time of writing. It may contain technical inaccuracies and typographical errors. The contents will be revised on a regular basis and changes will be implemented in subsequent versions. The described product(s) and the contents of this document may be changed or improved at any time without prior notice.

All rights reserved by JUMO GmbH & Co. KG No part of this document may be reproduced, published or publicly displayed in any form or by any means, nor may its contents be modified, translated, adapted, sold or disclosed to a third party without prior written permission of JUMO GmbH & Co. KG.

PLEASE NOTE

Find this document and further product information on our [product website](#).

1.1 Explanation of Warning Notices and Symbols

Safety precautions

Precautionary statements warn of hazards in handling the device and provide information on their prevention. The safety instruction labeling is classified by hazard severity and is divided into the following groups:

DANGER

Danger indicates hazards for persons. If the safety instruction marked in this way is not followed, the hazard will very likely result in severe injury or death.

WARNING

Warning indicates hazards for persons. If the safety instruction marked in this way is not followed, there is a risk of injury or death.

CAUTION

Caution indicates hazards for persons. If the safety instruction marked in this way is not followed, minor or moderate injuries may occur.

NOTICE

Notice signals danger to objects or data. If the notice is not observed, damage to property or data may occur.

Informational notes

Informational notes provide important information which stands out due to its relevance.

INFO

The information symbol indicates tips on handling the device or provides additional information on it. The information is useful for reaching optimal performance of the device.

The title field can deviate from "INFO" depending on the context. For instance, it may also read "PLEASE NOTE".

1.2 Safety Instructions

1.2.1. General Safety Instructions

NOTICE

Improper handling of the device may result in its damage.

- The hydroTRANS H50 enclosure, the sensing probe and the sensing module shall not be exposed to unnecessary mechanical stress.
- Do not apply the supply voltage to the RS485 data lines.
- The hydroTRANS H50 electronics is sensitive to electrostatic discharge (ESD), appropriate protective measures shall be taken when touching it.
- When replacing the filter cap make sure not to touch the sensing elements.
- The device must be operated with the filter cap on at all times.
- Installation, electrical connection, maintenance and commissioning shall be performed by qualified personnel only.
- The devices are designed for the operation with class III supply (EU) and class 2 supply (NA).
- The power supply must be switched off before opening the housing.
- Use the hydroTRANS H50 only as intended and observe all technical specifications.
- An existing Ethernet connection must be disconnected before opening the enclosure.

1.2.2. Alarm Module with Voltages >50 V (Additional Module Option 2)

WARNING

Hazards to persons may exist. If this safety instruction is not followed, there is a risk of injury or death.

- The optional alarm module is isolated from the low-voltage side of the hydroTRANS H50 by a special partition; this must remain fitted at all times in the base module of the enclosure.
- The hydroTRANS H50 enclosure must be tightly closed during operation. An open enclosure corresponds to IP00 and exposes components carrying dangerous voltage. Any work (maintenance for instance) on the device may be performed by qualified staff only.

1.2.3. Integrated power supply 100 - 240 V AC (Additional Module Option 3)

WARNING

Hazards to persons may exist. If this safety instruction is not followed, there is a risk of injury or death.

- The hydroTRANS H50 enclosure must be tightly closed during operation. An open enclosure corresponds to IP00 and exposes components carrying dangerous voltage. Any work (maintenance for instance) on the device may be performed by qualified staff only.

1.2.4. Intended Use

The hydroTRANS H50 sensors are designed to meet the highest demands of stable and highly accurate measurements of relative humidity (RH) and temperature (T) under the most challenging conditions. The RH and T sensor handles a wide range of applications from -80 °C (-112 °F) up to 180°C (356 °F) and 300 bar (4 350 psi), even under harsh environmental conditions such as constant high humidity and chemical contamination.

With different intelligent operating modes, hydroTRANS H50 can be perfectly tailored to the specific needs of each measurement task. Depending on the type and duration of the exposure (humidity, chemicals), the monolithic RH and T sensing element is exposed to an appropriate heating strategy.

The use of the hydroTRANS H50 in any other way than described in this manual bears a safety risk for people and the entire measurement installation and is therefore not allowed.

The manufacturer cannot be held responsible for damages as a result of incorrect handling, installation, and maintenance of the equipment.

The device may only be powered as described in this manual.

In order to avoid damage to the instrument or health hazards, the measuring equipment must never be manipulated with tools that are not specifically described in this manual. The sensor may only be utilized in accordance with the conditions defined in the technical data. Otherwise, measurement inaccuracies will occur and equipment failures cannot be ruled out. The steps recommended by the manufacturer for installation, inspections and maintenance work must be observed and carried out for the safety of the user and for the functionality of the equipment.

WARNING

Non-compliance with the product documentation may cause safety risk for people and the entire measurement installation.

The manufacturer cannot be held responsible for damages as a result of incorrect handling, installation and maintenance of the device.

- Do not use hydroTRANS H50 in explosive atmosphere or for measurement of aggressive gases.
- This device is not appropriate for safety, emergency stop or other critical applications where device malfunction or failure could cause injury to human beings.
- The device may not be manipulated with tools other than specifically described in this manual.

NOTICE

Failing to follow the instructions in this user manual may lead to measurement inaccuracy and device failures.

- The hydroTRANS H50 may only be operated under the conditions described in this user manual and within the specification included in chapter 9 Technical Data.
- Unauthorized product modification leads to loss of all warranty claims. Modification may be accomplished only with an explicit permission of JUMO GmbH & Co. KG!

1.2.5. Mounting, Start-up and Operation

The hydroTRANS H50 humidity and temperature sensor has been produced under state of the art manufacturing conditions, has been thoroughly tested and has left the factory after fulfilling all safety criteria. The manufacturer has taken all precautions to ensure safe operation of the device. The device has to be set up and installed in a way that does not impair its safe use. All applicable local and international safety guidelines for safe installation and operation of the device have to be observed. This user manual contains information and warnings that must be observed in order to ensure safe operation.

PLEASE NOTE

The manufacturer or his authorized agent can be only be held liable in case of willful or gross negligence. In any case, the scope of liability is limited to the corresponding amount of the order issued to the manufacturer. The manufacturer assumes no liability for damages incurred due to failure to comply with the applicable regulations, operating instructions or the specified operating conditions. Consequential damages are excluded from the liability.

WARNING

Non-compliance with the product documentation may cause accidents, personal injury or property damage.

- Mounting, installation, commissioning, start-up, operation and maintenance of the device may be performed by qualified staff only. Such staff must be authorized by the operator of the facility to carry out the mentioned activities.
- The qualified staff must have read and understood this user manual and must follow the instructions contained within.
- All process and electrical connections shall be thoroughly checked by authorized staff before putting the device into operation.
- Do not install or start-up a device supposed to be faulty. Make sure that such devices are not accidentally used by marking them clearly as faulty.
- A faulty device may only be investigated and possibly repaired by qualified, trained and authorized staff. If the fault cannot be fixed, the device shall be removed from the process.
- Service operations other than described in this user manual may only be performed by the manufacturer.

1.3 Environmental Aspects

PLEASE NOTE

Products from JUMO GmbH & Co. KG are developed and manufactured in compliance with all relevant environmental protection requirements. Please observe local regulations for the disposal of the device.



For disposal, the individual components of the device must be separated according to local recycling regulations. The electronics shall be disposed of correctly as electronics waste.

1.4 ESD Protection



The sensing elements and the electronics board are ESD (electrostatic discharge) sensitive components of the device and must be handled as such. Failure to do so may damage the device by electrostatic discharge when touching exposed sensitive components.

2 Scope of Supply

	Included in all versions	With option
hydroTRANS H50 according to ordering guide	✓	
Manual hydroTRANS H50	✓	
Inspection certificate according to DIN EN 10204-3.1	✓	
Mating plug for integrated power supply		Additional module option 3
Mating plug RKC 5/7		Additional module option 3, electrical connection options 4, 6
Mating plug RSC 5/7		Electrical connection option 4
M16 cable gland		Except for additional module option 3, electrical connection options 4, 6
Cut-in fitting		Type 907055/30

3 Product Description

3.1 General

The hydroTRANS H50 is available with 4 remote probe types according to the applications RH/T/p range and environmental condition like high humidity and chemical pollution. It offers various probe and cable lengths (for the dimensions, please refer to chapter 3.6 Dimensions)

Probe Type	Description
10	Remote probe up to 180 °C (356 °F)
20	Remote probe, pressure-tight up to 20 bar (290 psi) and 180 °C (356 °F), with sliding fitting
30	Remote probe, pressure-tight up to 300 bar (4 350 psi) and 180 °C (356 °F), with cut-in fitting
40	Two remote probes, pressure-tight up to 20 bar (290 psi) and 180°C (356 °F), with optional cut-in fitting

The employed high-end RH and T sensing element is heated autonomously and enables reliable and long-term stable measurements in extremely humid or chemically polluted environments. The monolithic structure of the RH and T sensing element ensures a fast return to normal conditions after condensation or chemical contamination. In addition, it is perfectly protected by the proprietary coating.

Different heating modes of the monolithic RH and T sensing element allow for best adaption to the specific needs of each measuring task. Furthermore, probe type 40 offers a dual heating system (probe body and sensing element are heated) to prevent condensation on the RH sensing element and on the probe body for continuous high humidity operation.

The measured data is available on two freely scalable analogue outputs, on the RS485 (Modbus RTU) or Ethernet-PoE (Modbus TCP, M12 X-coded connection) interface and on the alarm (relay) outputs. The configuration and the RH and T adjustment of the hydroTRANS H50 can be performed with the free PCS Configuration Software. An optional 3.5" colour display with push-buttons is available for configuration and visualisation.

The hydroTRANS H50 with option 7 features the intelligent pluggable probe, which enables a plug-and-play probe exchange.

The optional Automatic ReCOVERY (ARC) module allows for external triggering of the heating functionality.

With integrated power supply option, the hydroTRANS H50 can be powered with 100 - 240 V AC (50/60 Hz), 2 VA.

3.2 Product Design

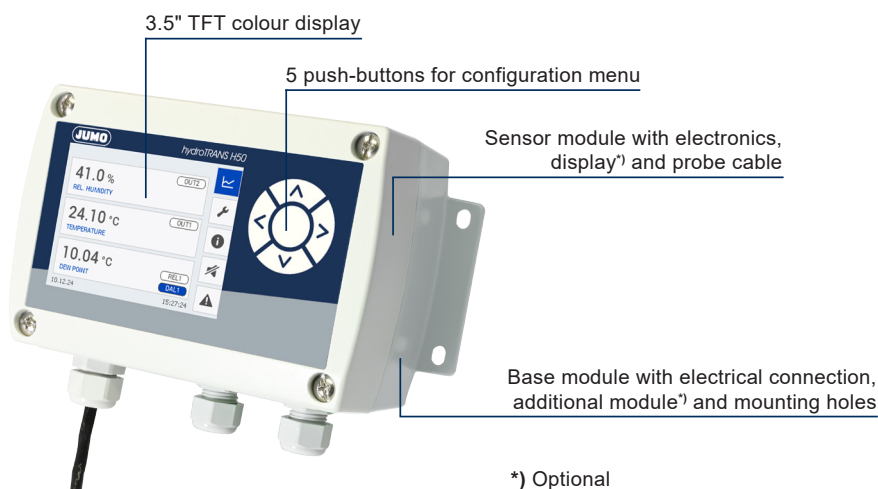
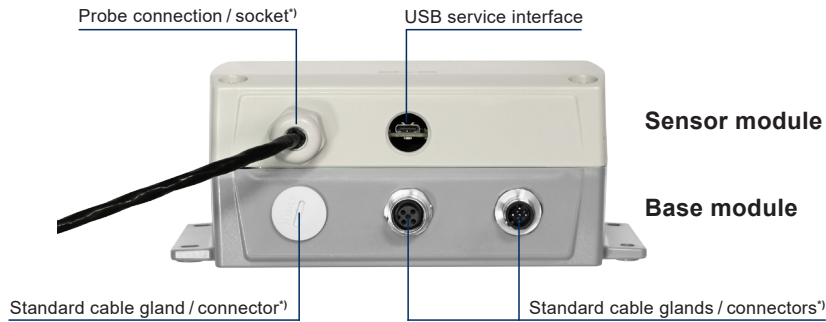

Fig. 1 hydroTRANS H50 perspective view



*) Depending on electrical connection options

Fig. 2 hydroTRANS H50 connector-side view

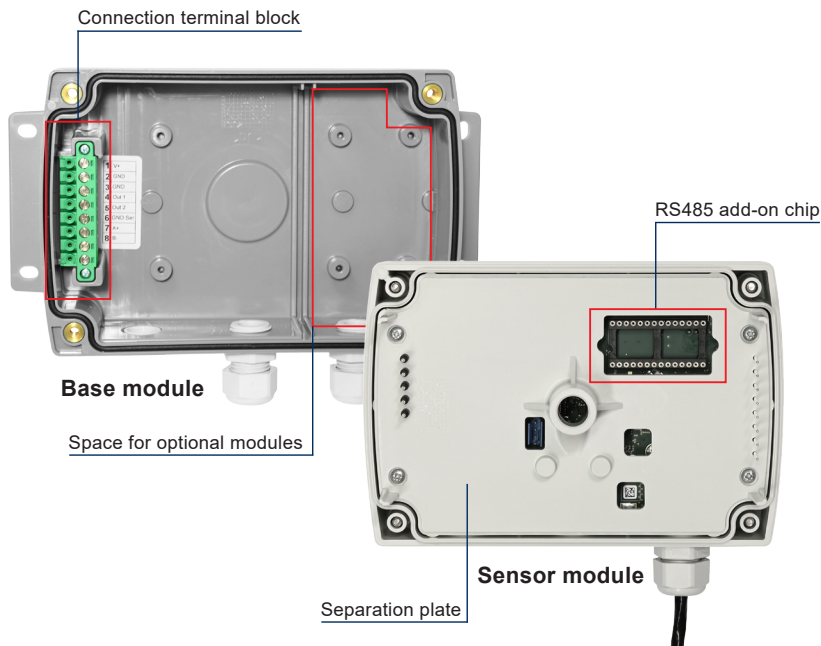

Fig. 3 hydroTRANS H50 modular polycarbonate enclosure inside view

3.3 Configuration Interface

The hydroTRANS H50 is ready to use and does not require any further configuration. The factory setup of hydroTRANS H50 corresponds to the specified order code. Please refer to the datasheet at our [product website](#). If needed, the factory setup can be changed with the

- Free PCS Configuration Software.
Please refer to chapter 6.1 PCS Configuration Software.
- Display and push-buttons (if the optional display is selected)
Please refer to chapter 1.2.1. General Safety Instructions.
- Modbus RTU protocol (if the RS485 option is selected).
Please note that configuration is limited to the Modbus communication settings.
Please refer to chapter 6.2 RS485 Digital Interface.

3.4 Operation and Heating Modes

3.4.1. Overview Operation Modes and Types

Operating Mode	Probe Type	Use in Environments with	Function Trigger
Condensation Guard (CG)	10 / 20 / 30	Temporary condensation	RH setpoint ¹⁾
High Humidity Guard (H ² G)	40	Continuous high humidity and condensation	Always on

1) Factory setting: 99 %RH

3.4.2. Automatic ReCover (ARC) against Chemical Pollution

When capacitive humidity sensing elements are exposed to chemical pollution (e.g. detergent residues), the presence of foreign molecules can distort the measurement reading of the sensor. With the ARC function foreign molecules can be evaporated from the sensing element by brief and intensive heating.

All hydroTRANS H50 types support the ARC function.

i PLEASE NOTE

Before a recalibration is done after an ARC cycle, reconditioning of the sensing element is recommended. For best reconditioning, please allow 2 free calibration cycles between 15 %RH and 90 %RH in steps of ~20 %RH and 20 min stabilisation time.

The start of the ARC function can be triggered as follows:

Manual: by using PCS or via display and push-buttons. A manual start of the ARC function is recommended when

- chemical pollution on the sensing element is expected (cleaning/sterilization)
- measurement readings deviate significantly from a calibration reference.

Cyclic: by using PCS, ARC can be configured to start periodically at a certain time interval.

The cyclic option can be extended to include an automatic start at power on. This function can be switched on and off via PCS or display and push-buttons.

Periodic heating shall be used to minimize drift effects in applications with high chemical pollution. The ideal cycle time depends on the type of pollution and its concentration and has to be determined empirically.

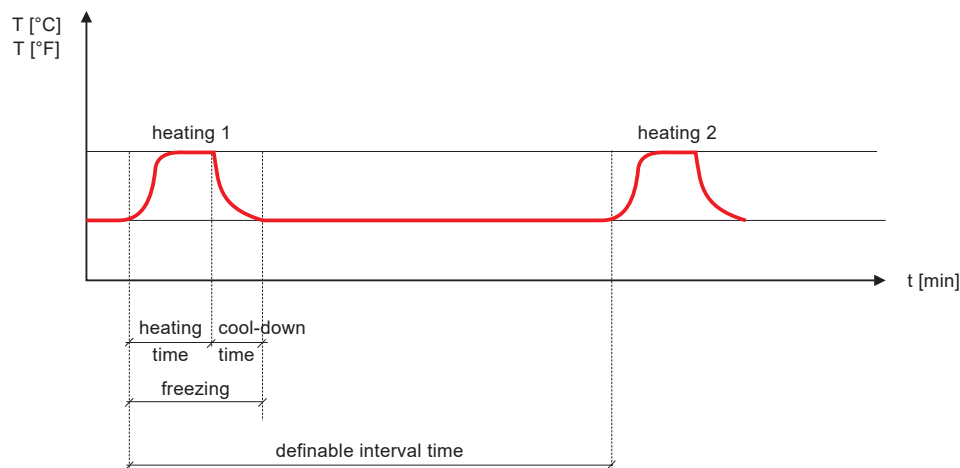

Fig. 4 ARC cycle

External: by using the optional ARC module the function can be activated using an external signal see chapter 1.2.1. General Safety Instructions. RS485 or Ethernet with Modbus commands can be used to start ARC as well.

The ARC parameters can be configured via PCS or display and push-buttons:

Heating duration: Defines the time in which the monolithic measurement cell is intensively heated. A heating time of at least 20 minutes (20 min = factory setting) is recommended if chemical pollution has occurred.

Recovery duration: The cool-down time is necessary for the sensing element to cool back down to ambient temperature. The cool-down time should be at least 3 minutes (3 min = factory setting) in order to prevent measurement errors.

During the ARC process (heating and cool-down time) the values on the outputs are frozen. In other words, the measuring values at the outputs are kept constant during the process.

The orange LED D5 at the main PCB near the USB interface is permanently lit during the ARC process. An orange frame and text on the display also indicates the ARC process. On the status page of the display, the remaining ARC process time in seconds is displayed.

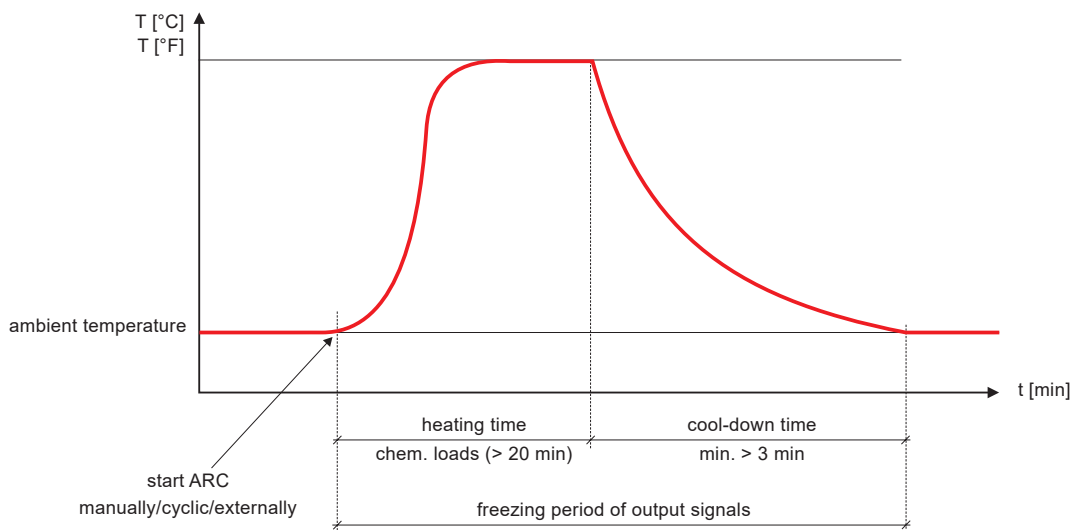

Fig. 5 ARC process in detail

i PLEASE NOTE

If the defined cool-down time is too short, the measurements may be incorrect.

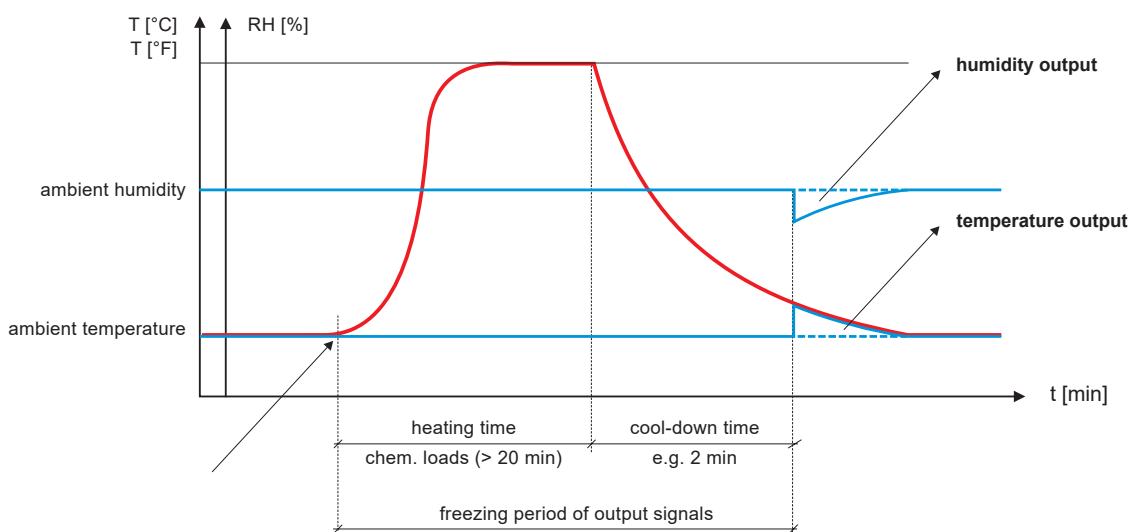

Fig. 6 ARC cycle with cool-down time too short

3.4.3. Condensation Guard (CG) against Temporary Condensation

Temporary condensation on the sensing element in highly humid environments is eliminated when a specified RH set point (factory setting: 99 %RH) is reached. By intensive heating of the sensing element for 10 seconds occurring dew is evaporated. Due to its monolithic structure, the sensing element cools off quickly within approximately 3 minutes and returns to its measurement function.

If condensation is still detected after the CG process, it restarts immediately or after a predefined lock time.

During the complete heating and cool-down process, the values on the outputs are frozen. In other words, the measuring values at the analog outputs are kept constant during the CG cycle.

The following types support the Condensation Guard: 10 / 20 / 30.

i PLEASE NOTE

The lock time has to be set according to the application needs. A too short lock time might result in permanent freezing of the outputs.

The CG function can be parameterized via the PCS Configuration Software.

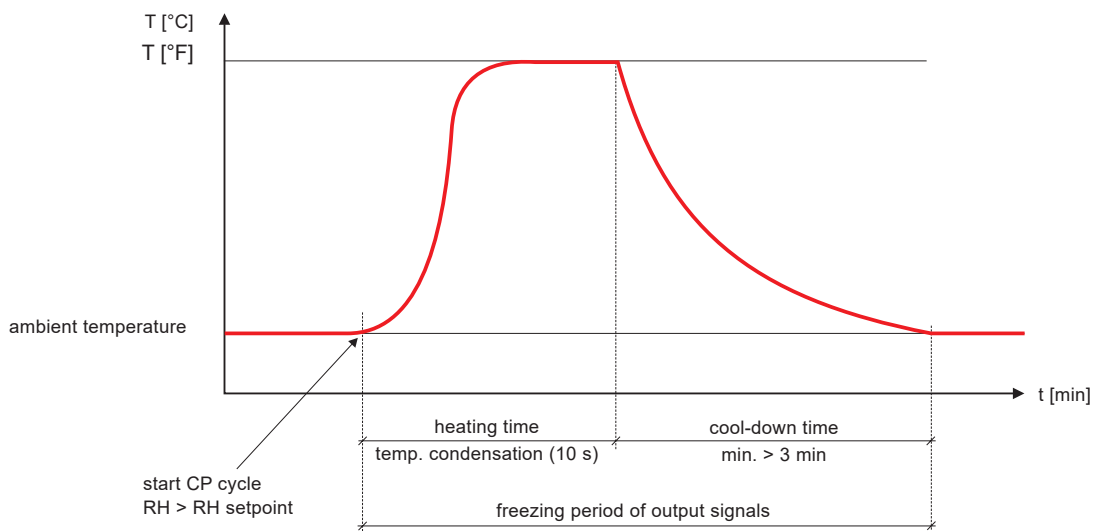

Fig. 7 CG process in detail

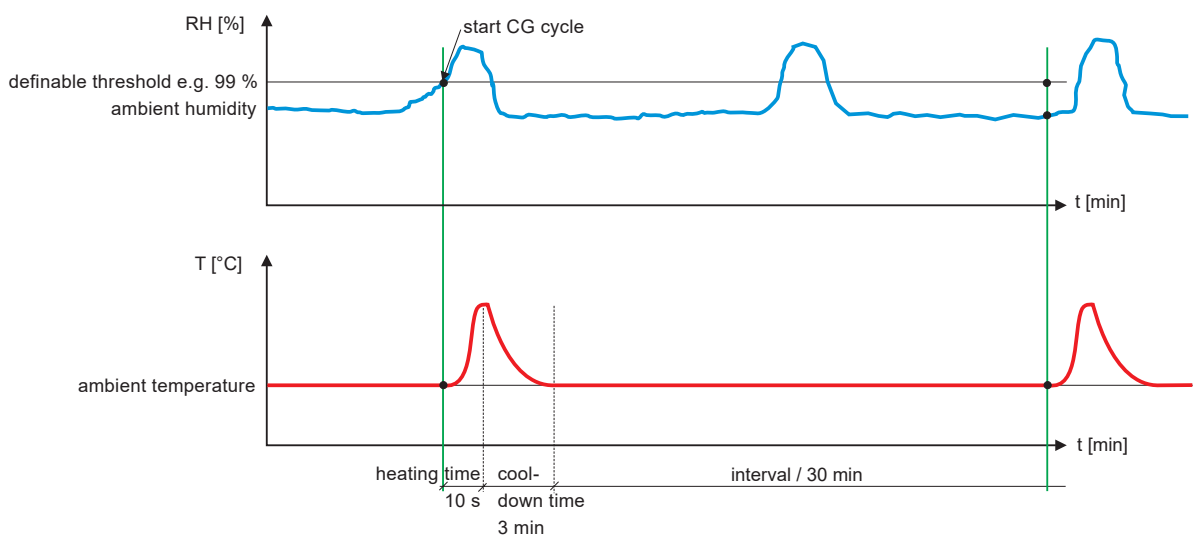

Fig. 8 CG cycles with a lock time of 30 min

i PLEASE NOTE

When heating has ended, the system blocks any subsequent heating for 30 minutes. If the ambient humidity remains above the defined set point after the initial heating, the next heating starts again after 30 minutes.

3.4.4. High Humidity Guard (H²G) against Continuous High Humidity and Condensing Conditions

In environments with continuous high humidity even the smallest deviations between the temperature of the sensor head and the ambient temperature can cause condensation. Dew on the RH / T sensing element influences the measurement accuracy and increases the risk of deposits on the active sensor surface that lead to parallel resistances and parasitic capacitances.

The dual heating system of the hydroTRANS H50 prevents both, condensation on the RH sensing element and on the probe body, by a regulated heating strategy. This leads to very short response time and fast recovery after condensing conditions. Furthermore, it enables accurate RH measurement even under continuously high humidity and condensing conditions. RH and T can be determined precisely with the help of the heated monolithic sensing element and the calculated dew point. The relative humidity near condensation is determined with the T value of an additional T probe of type 40.

The following hydroTRANS H50 type incorporates the dual heating system:
40: with additional T Sensor included for RH measurement

3.5 Optional Features

3.5.1. TFT Colour Display

This option includes a 3.5" TFT colour display and push-buttons for full configuration.

Configuration Menu

Detailed information on the configuration menu see chapter 11 Appendix: Display Menu Structure.

Menu

Data logging	Configuration of the data logger/graph - sampling rate graphs
Display settings	Display layout - measurands brightness orientation display alarm
Analog output	Output configuration - mode measurands scaling error indication
Heating mode settings	ARC and CG configuration - activation deactivation parameters
Alarm output*	Relay configuration - mode set points state
Customer adjustment	Adjustment - 1 and 2 point humidity/temperature adjustment reset to factory adjustment calibration status
Modbus settings*	Configuration of Modbus RTU data transmission
IP settings*	Configuration of Ethernet module
Device settings	Settings - language date, time parameters password protection
Status	Status and device information

* Menu only available with the corresponding optional module.

Fig. 9 Principal configuration menu structure

i CONFIGURATION HINT

Display alarms can be configured via display and push-buttons only. Configuration is to be done in the "Display settings" menu.

The hydroTRANS H50 display also includes a data logger with a storage capacity of 20 000 values per measurand or calculated quantity.

During the first 5 seconds after display start-up, the data logger and the configuration menu are initialized.

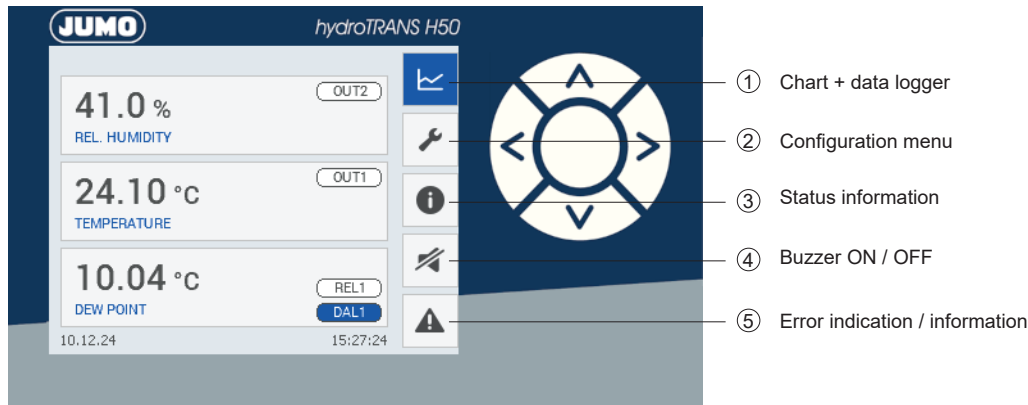

Fig. 10 Control panel with display and push-buttons

Data Logging

The TFT display with the integrated data logging function saves all measured and calculated values to the internal memory. The data logger has a real time clock (UTC time) with a battery back-up.

NOTICE

Changing the UTC time erases all stored data.

The data logger can save 20 000 values for each measurand. The logging interval is user configurable from 1 second to 12 hours. The data logging menu is also used to select the data points that make up the graph and for scaling, see chapter 11.2, Fig. 45 Data logging.

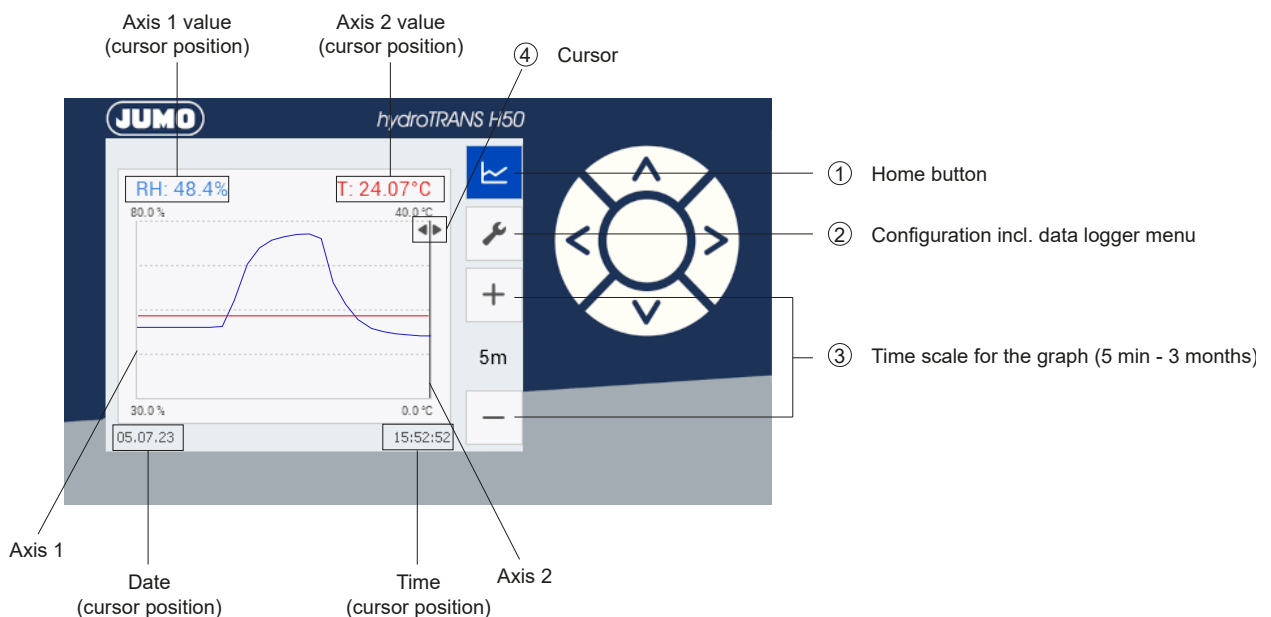

Fig. 11 Data logging

Each point in the graph represents a logged value. The points are connected by linear interpolation.



Fig. 12 Data logger graph

The data logger memory works according to the first in first out (FIFO) principle: new data is stored while the oldest data is deleted. The latest 20 000 logged values are available in the internal memory.

The logged data can be downloaded with PCS Configuration Software as .csv file by choosing the measurands and the time period.

Status Information

The status information shows all actual hydroTRANS H50 settings and measured values.

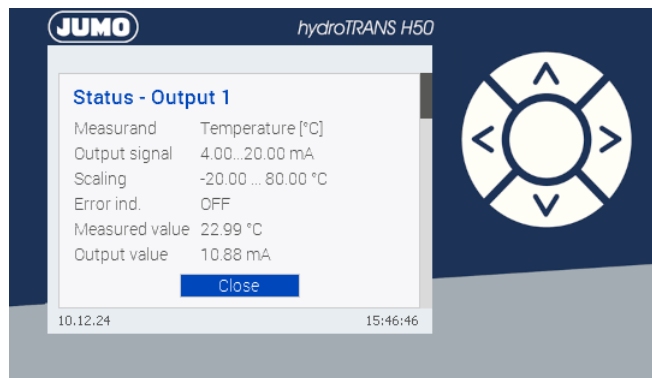

Fig. 13 Status information

Buzzer

If a previously configured limit value is violated, a buzzer sounds periodically. This buzzer can be switched off or on here. Factory default is on.

Error Indication

As soon as an error occurs, an indication shows the error code.

3.5.2. Smart Probe (Probe Connection Option 7)

The hydroTRANS H50 with probe connection option 7 features the intelligent pluggable probe. The smart probe enables a plug-and-play probe exchange during operation without any configuration, adjustment or calibration. The sensing element data of the smart probe is determined in the RH factory calibration systems. Upon connection to the hydroTRANS H50, the probe automatically uploads its specific parameters to the hydroTRANS H50 electronics.

This enables simple maintenance procedures at the customer's site without "down time" due to cost-intensive recalibration/repair and even without manual parameterization of the new probe. The smart probe enables quick replacement without any tools at any time, even during operation (hot-swap).

i PLEASE NOTE

Replacing a smart probe results in an additional uncertainty in the RH measurement. This is due to the variation of the capacitive and resistive coupling at the connector. The additional uncertainty after a smart probe replacement is typically $< \pm 0.15\% \text{RH}$ @70 %RH and $< \pm 0.05\text{ }^\circ\text{C}$.

To ensure the initial accuracy of the hydroTRANS H50, an adjustment after the smart probe exchange is recommended.

If smart probes with different cable lengths are exchanged on an hydroTRANS H50 (e.g. smart probe change from 10 m to 1 m cable length), an adjustment must be carried out.

For probe type 40, only the RH probe is exchangeable. The T probe is fixed.

3.5.3. ARC Module (Additional Module Option 1)

The additional circuit board located in the hydroTRANS H50's base module offers the possibility to start the ARC heating function with external signal.

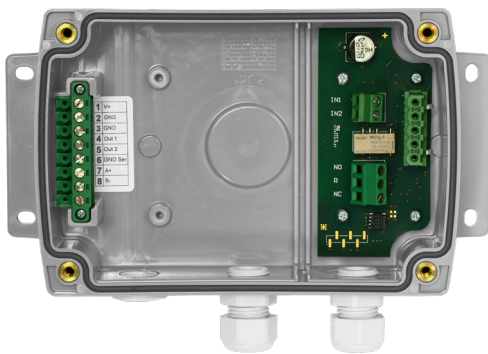

Fig. 14 ARC module in polycarbonate enclosure

During the ARC process the orange LED 5 at the main PCB near the USB interface is permanently lit (refer to Fig. 40). An orange frame and text on the display also indicates the ARC process. The remaining time span of the ARC process is indicated in seconds in a device information register. Please refer to chapter 6.2.1. Modbus RTU Setup. On the status page of the optional display, the remaining seconds of the ARC process are displayed.

Heating process and trigger parameters can be set and changed with the PCS and via the display and push-buttons.

Electrical Connection

Terminal "Input": External signal trigger

IN1 signal (24 V DC; 10 mA)

IN2 GND

Terminal "Status": Feedback signal to the external control

NO / R / NC

The NO contact is closed during the heating process, otherwise opened.

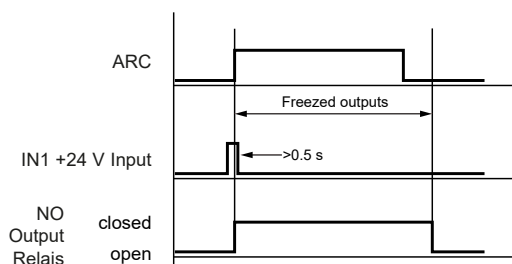

Fig. 15 ARC timing

3.5.4. Alarm Module (Additional Module Option 2)

The module offers two freely configurable relay outputs for alarm or control purposes. Various operation modes are available including switch hysteresis, switch window and error indication. The error modes can be configured independently from each other. The measurands at the outputs as well as switching points, hysteresis and the normal state (standard / inverted) can be set via PCS Configuration Software or using the push-buttons (see chapter 11.3 Optional Menus, Fig. 52 Alarm output).

Switch Hysteresis Mode

The switching behavior is determined by entering a switching point and an associated hysteresis value.

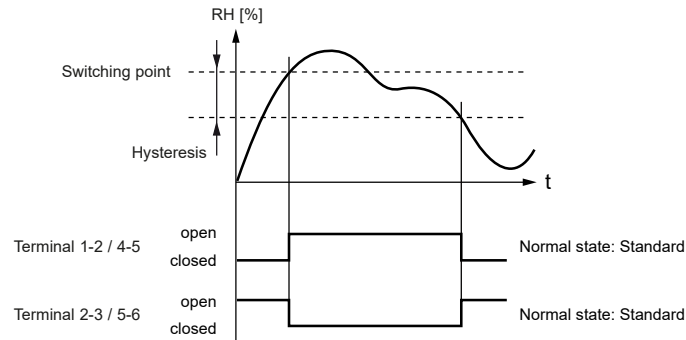

Fig. 16 Example hysteresis mode on both alarm outputs using normal state standard

Additionally, detected errors are signaled at the alarm output.

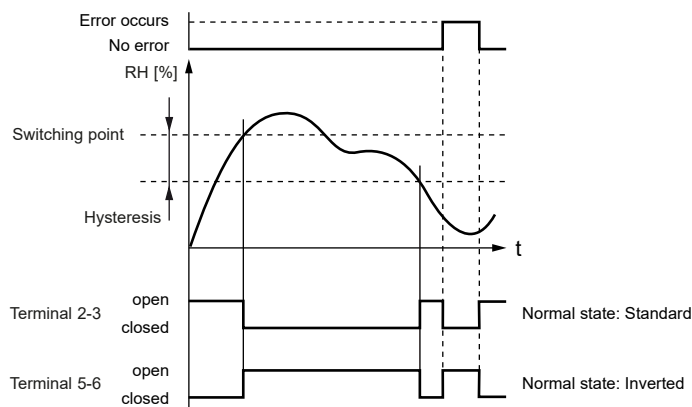

Fig. 17 Example of hysteresis mode with error occurring

Switch Window Mode

The switching behavior is determined by entering two switching points and two associated hysteresis values.

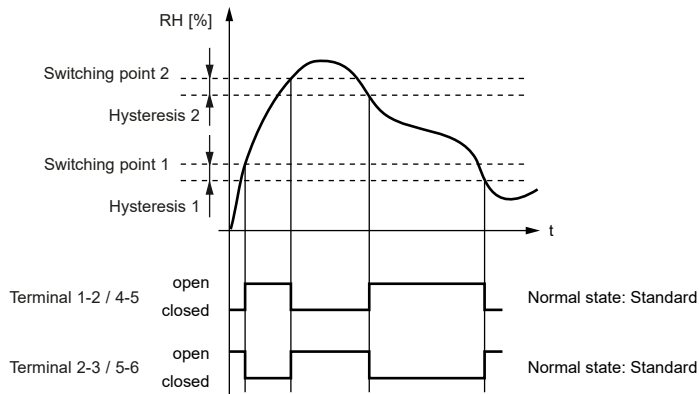

Fig. 18 Example window mode on both alarm outputs using normal state standard

Additionally, detected errors are signaled at the alarm output.

Error Indication Mode

When error indication mode is selected, various errors will trigger the alarm output.

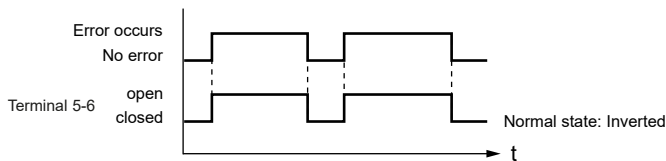

Fig. 19 Example of error mode on relay 1 using normal state inverted

i PLEASE NOTE

An alarm output in this operation mode is used for error indication only (no combination with switching points possible).

Electrical Connection and Switch Load

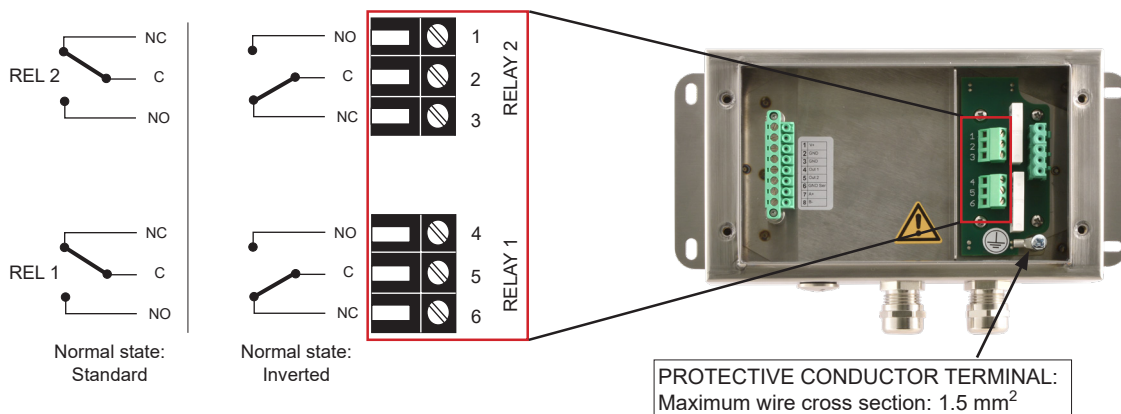

Fig. 20 Alarm module (additional module option 2)

⚠ WARNING

The metal enclosure must be grounded during operation. National regulations for installation must be observed!

Switch Load

Max. switch load	250 V AC / 6 A 28 V DC / 6 A
Min. switch load	12 V / 100 mA

Tab. 1 Maximum and minimum switch loads

⚠ WARNING

No overcurrent and short circuit protection. Both relays shall be connected to either high oder low voltage.

3.5.5. Integrated Power Supply 100 - 240 V AC (Additional Module Option 3)

This module allows the hydroTRANS H50 to be powered with 100 - 240 V AC (50/60 Hz), 2 VA.



Polycarbonate enclosure



Stainless steel enclosure

Fig. 21 Power supply module (additional module option 3)

⚠ WARNING

The additional module option 3 includes a 1.25 A fuse on the 100 - 240 V side. This fuse must not be replaced by the user, only by the after sales service.

The protection of the supply cable against excess current and short-circuit must be designated to a wire cross section of 0.8 mm² (AWG 18) (6 A fuse).

The metal enclosure must be grounded during operation.

All national regulations for installation shall be observed!

3.5.6. RS485 Module - Modbus RTU (Digital Interface Option 3)

Up to 32 hydroTRANS H50 sensors with Modbus RTU interface can be connected in an RS485 bus system (1 unit load).

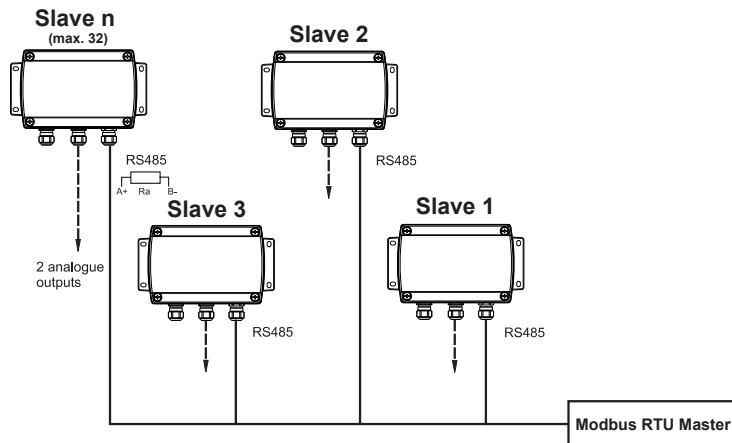

Fig. 22 2-wire RS485 bus

i PLEASE NOTE

Both ends of the bus shall be terminated with a resistor $R_a = 120 \Omega$.

The setup of the Modbus RTU communication can be performed via PCS Configuration Software or via display and push-buttons, see chapter 11.3, Fig. 53 Modbus settings.

Modbus RTU protocol settings

	Factory settings	User selectable values (via PCS)
Baud rate	9 600	9 600, 19 200, 38 400, 57 600, 76 800
Data bits	8	8
Parity	Even	None, odd, even
Stop bits	1	1, 2
Modbus address	230 (0xE6)	1...247

Tab. 2 Modbus RTU protocol settings

i PLEASE NOTE

The recommended settings for multiple devices in a Modbus RTU network are 9 600, 8, even, 1.

3.5.7. Ethernet Module - Modbus TCP (Digital Interface Option 4)

The Ethernet module features power over Ethernet (PoE) with an M12 X-coded electrical connection. The M12 X-coded socket is mounted in the enclosure's base module.

To secure an IP65 rated connection use appropriate M12 X-coded cables or connectors (not in the scope of the supply), for example:

Cable and connector example for IP65-rated M12 X-coded connection

Cable	Tensility 10-0396x (x = options for different cable lengths)
Connector	AdamTech SD-MMX08-MMTDL-IX0-000, IDC

i PLEASE NOTE

The Ethernet connection shall be disconnected before opening the enclosure.

Available TCP and UDP Ports

- Modbus TCP: Port 502

See “Modbus TCP/IP implementation guide” which can be found at www.modbus.org/docs/Modbus_Messaging_Implementation_Guide_V1_0b.pdf.

The unit identifier of the MBAP header is not used and can be any value from 0 to 255.

- HTTP webserver: Port 80

For a quick communication check, enter the IP address in a web browser and connect with the hydroTRANS H50 Ethernet module’s Webserver.

Alternatively, send an ICMP echo request (“ping”) to check correct communication settings.

IPv4 Settings

	Factory settings
IP Address	192.168.0.64
Subnet Mask	255.255.255.0
Gateway	192.168.0.1
DNS	192.168.0.1

Tab. 3 IPv4 settings

DHCP options can be set with jumper on the electronics board, refer to Fig. 23. Factory setting: DHCP disabled (static IP).

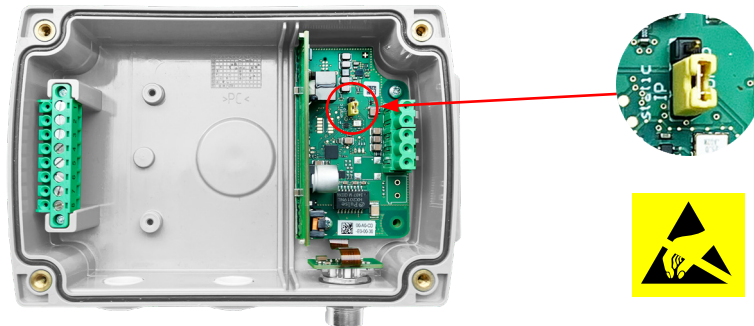

Fig. 23 Ethernet module - DHCP setting

The setup of the Modbus TCP communication can be performed via PCS Configuration Software or via display and push-buttons, see chapter 11.3 Optional Menus Fig. 54 IP settings.

Modifying the IP address via PCS or display is possible only when the DHCP jumper is set to “Static”. Otherwise the IP settings are read-only.

NOTICE

Supported Ethernet standard: 802.3i/u/x and af.

IPv6 is not supported.

3.6 Dimensions

Values in mm / inch

Enclosure

Polycarbonate

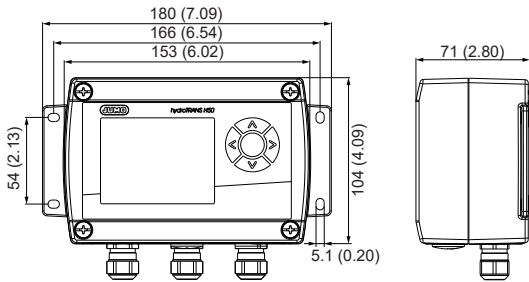

Stainless steel

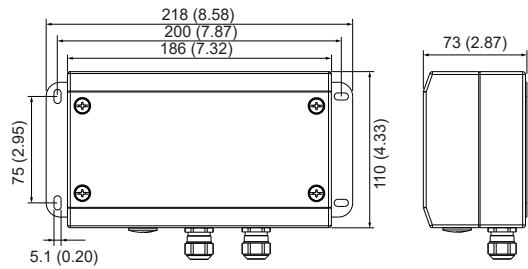

Probe Type 10

Up to 180 °C (356 °F)

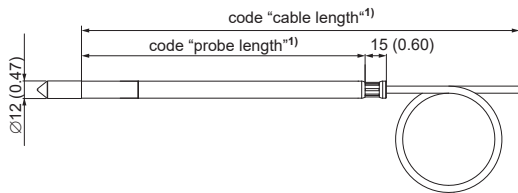

Probe Type 30

Pressure-tight up to 300 bar (4 350 psi) with cut-in fitting

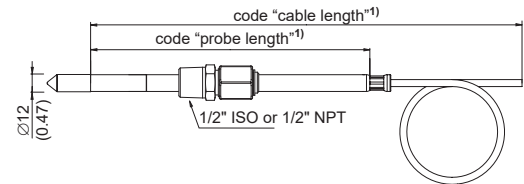

Probe Type 20

Pressure-tight up to 20 bar (290 psi) with sliding fitting

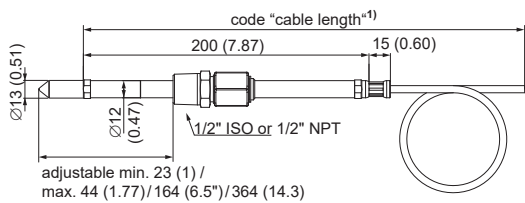

Probe Type 40

Pressure-tight up to 20 bar (290 psi) with optional cut-in fitting

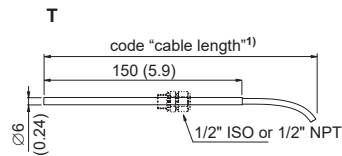
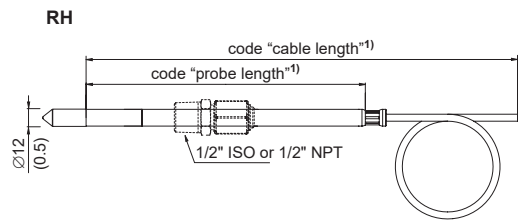

4 Mounting and Installation

4.1 Sensor Enclosure

Mounting with Screws

- Drill the mounting holes according to the corresponding mounting pattern below.
- Mount the base module of the enclosure with 4 screws (screw diameter < 4.2 mm (0.2"), not included in the scope of supply).

Values in mm (inch).

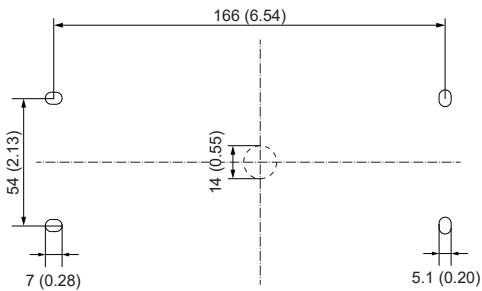

Fig. 24 Drilling pattern of polycarbonate enclosure

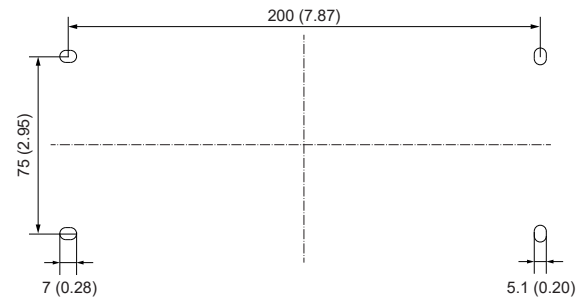

Fig. 25 Drilling pattern of stainless steel enclosure

DIN Rail Mounting of the Polycarbonate Enclosure

- Mount the two DIN rail brackets onto the base module. (material number 00448810)
- Snap in the enclosure onto the DIN rail.

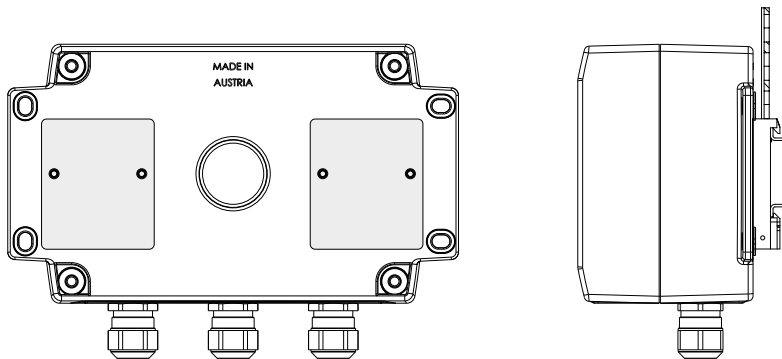

Fig. 26 DIN rail installation

4.2 General Information for Mounting hydroTRANS H50 Sensing Probes

i PLEASE NOTE

For accurate measurement it is of paramount importance to avoid T gradients along the probe. In case of large T difference between the front and the back of the probe, it is highly recommended to insert the probe completely into the process. Should this not be possible, place a thermal isolation layer on the part of the probe outside the process (on the cable side).

i PLEASE NOTE

The sensing probe must be mounted horizontally or vertically, pointing downwards. If possible, a drip sheet should be fitted for each mounting.

i PLEASE NOTE

For probe hanging by its cable from the ceiling in applications where condensation is likely to happen it is important to avoid condense water getting from the cable to the probe and into the sensing head. For this use the drip water protection (material number 00566286).

i INSTRUCTIONS FOR INSTALLATION IN A HIGH-HUMIDITY ENVIRONMENT

If the process temperature differs significantly from the ambient temperature, the sensing probe should be fully inserted into the process to avoid incorrect measurements and condensation problems on the sensor head due to thermal conductivity.

It is recommended not to bring the sensing probe and colder metal parts in direct contact in order to avoid condensation problems caused by thermal conductivity.

4.3 Remote Sensing Probe Type 10

For mounting the probe into a separation wall use the stainless steel mounting flange. The immersion depth is adjustable. The probe shall be mounted horizontally.

Values in mm (inch)

Probe into separation wall

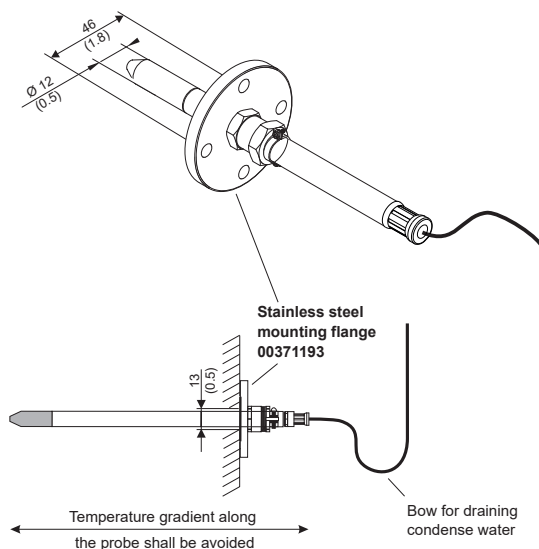

Hanging probe

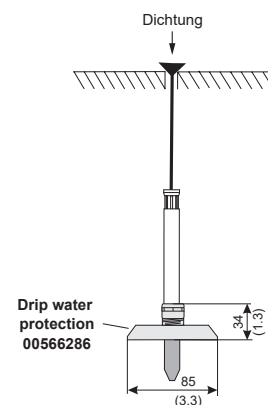

Fig. 27 Mounting the remote probe of hydroTRANS H50 probe type 10

The stainless steel mounting flange is not appropriate for pressure-tight mounting. For pressure-tight requirements use hydroTRANS H50 with probe type 20.

4.4 Remote Sensing Probe Type 20

⚠ WARNING

General safety instructions for pressure tight installation

The installation, commissioning and operation of the hydroTRANS H50 with probe type 20 may be performed by qualified staff only. Special attention shall be paid to the correct installation of the probe into the process. In case of inappropriate installation there is the risk for the probe to be suddenly expelled due to the pressure in the process.

Bending over the sensing probe should be avoided under any circumstances!

Make sure that the surface of the probe is not damaged during installation. A damaged probe surface may lead to damaged seals and consequently to leakage and pressure loss.

The probe is rated with leakage rate B according to EN12266-1.

4.4.1. Installation of the Probe directly in the Process

NOTICE

For direct probe installation shut-off valves shall be placed on both sides of the probe insert (see Fig. 28 below). This allows the sensor probe to be easily removed for maintenance and calibration.

For direct installation into a pressure chamber make sure that the pressure in the chamber and the ambient pressure are equal before removing the probe. The temperature during probe installation may deviate by max. ± 40 °C (± 72 °F) from the regular temperature during normal operation.

Replace the metal sealing ring (see Fig. 28) by a new one every time before re-installing the probe.

Probe installation steps

1. Close both shut-off valves.
2. Place the sensor probe into the probe insert and adjust the immersion depth.
3. Tighten the lock nut with a torque of 30 Nm.
4. Open the shut-off valves.

⚠ WARNING

Observe strictly the tightening torque. A torque lower than 30 Nm results in a smaller retention force of the clamping sleeve. This leads the risk of sudden expulsion of the sensing probe due to the pressure. A torque higher than 30 Nm may lead to permanent deformation of the clamping sleeve and the sensing probe. This would make the removal and re-installation of the probe difficult or even impossible.

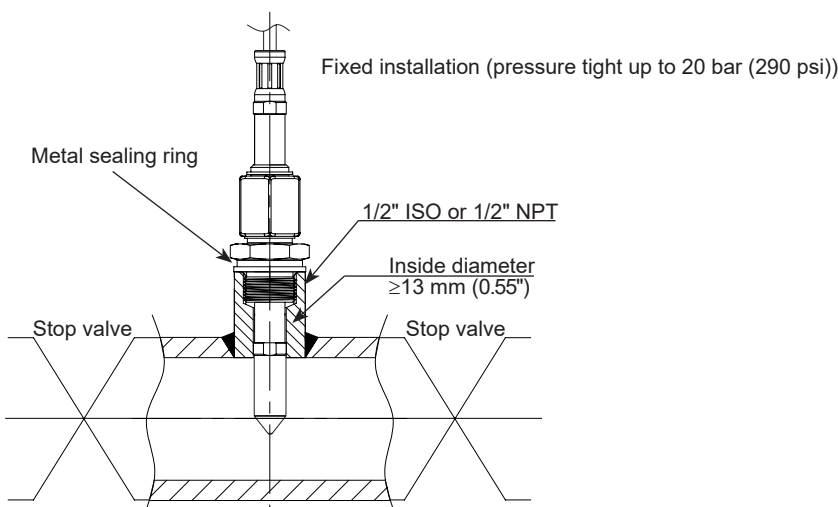

Fig. 28 Installation of the hydroTRANS H50 probe type 20 directly into the process

4.4.2. Installation of the Probe with Ball Valve Set

The ball valve set allows for installation and removal of the probe without process interruption. For mounting into a duct, the ball valve shall be installed perpendicular to the flow direction.

NOTICE

The two metal sealing rings (see Fig. 29 Installation of the probe by utilizing the ball valve set) shall be replaced every time prior to re-installing the probe.

The temperature during probe installation may deviate by max. ± 40 °C (± 72 °F) from the regular temperature during normal operation.

Installation of the probe (see Fig. 29)

1. Install the probe into the ball valve while the ball valve is closed.
2. Open the ball valve.
3. Slide the probe through the ball valve to the desired immersion depth. Depending on the process pressure additional tools may be necessary for pushing the probe into the process. Make sure not to damage the probe and the cable.
4. Tighten the lock nut with a torque of 30 Nm.

⚠ WARNING

Observe strictly the tightening torque. A torque lower than 30 Nm results a smaller retention force of the clamping sleeve. This leads the risk of sudden expulsion of the sensing probe due to the pressure. A torque higher than 30 Nm may lead to permanent deformation of the clamping sleeve and the sensing probe. This would make the removal and re-installation of the probe difficult or even impossible.

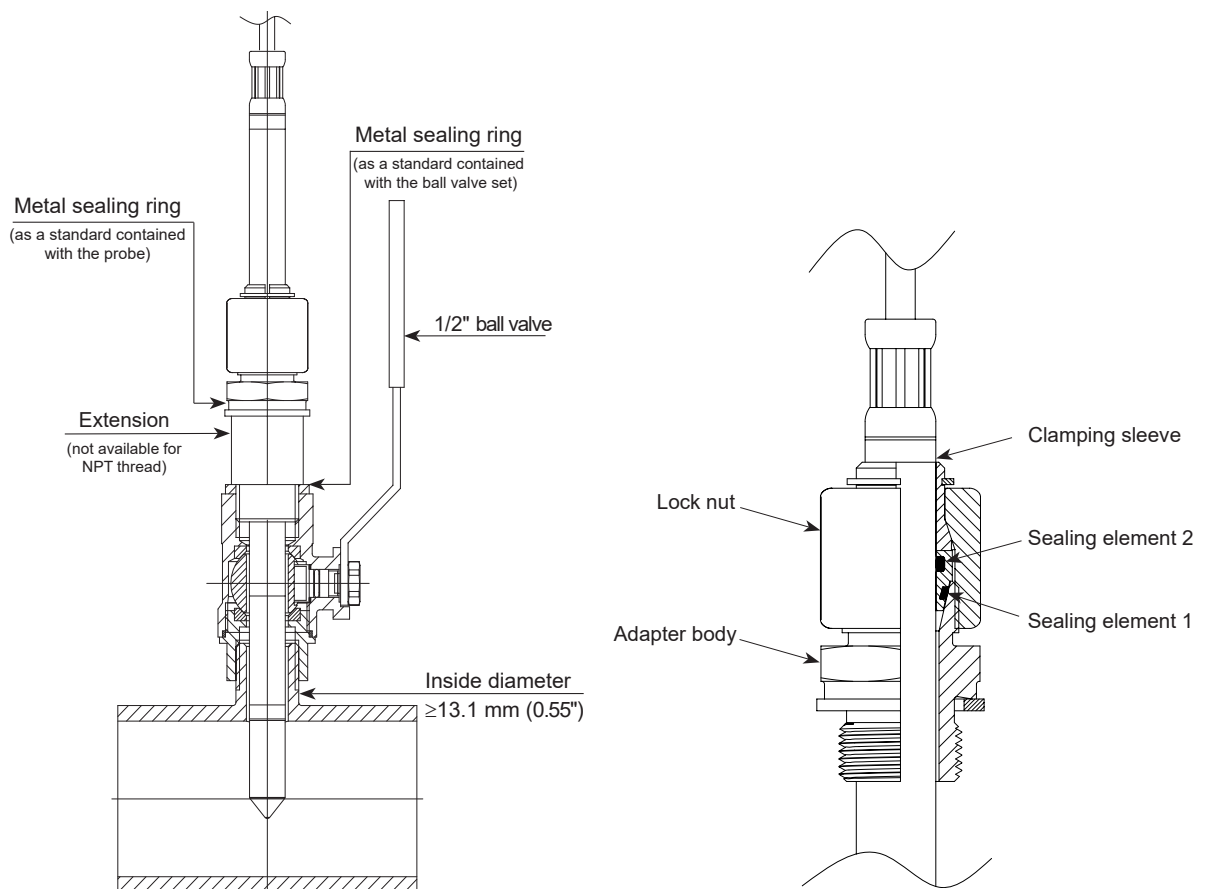

Fig. 29 Installation of the probe by utilizing the ball valve set

Removing the probe

1. Hold firmly the probe to avoid it being suddenly expelled when releasing the lock. Do not bend damage the probe cable.
2. Loosen slowly the lock nut with a spanner (spanner width 24) only till the probe is pushed out by the overpressure in the process. Do not completely loosen the lock nut, but only as much as necessary for the probe to slide.
3. After the probe has been pushed out of the process up to the stop, close the ball valve.
4. Remove the probe from the ball valve.

NOTICE

Observe the correct positioning of the sealing element 1 before reinstalling the probe.

4.5 Remote Sensing Probe Type 30

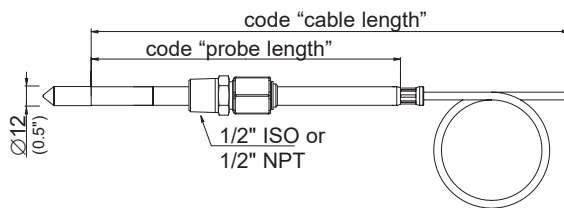

For pressure-tight installation up to 300 bar (4 350 psi) the remote sensing probe type 30 comes with a pressure-tight feedthrough within the scope of supply.

⚠ WARNING

General safety instructions for pressure-tight installation

The installation, commissioning and operation of the hydroTRANS H50 with probe type 30 may be performed by qualified staff only. Special attention shall be paid to the correct installation of the probe into the process. In case of inappropriate installation there is the risk for the probe to be suddenly expelled due to the pressure in the process.

Bending over the sensing probe should be avoided under any circumstances!

Make sure that the surface of the probe is not damaged during installation. A damaged probe surface may lead to damaged seals and consequently to leakage and pressure loss.

The probe is rated with leakage rate B according to EN12266-1.

⚠ CAUTION

Safety instructions for pressure-tight feedthrough

Do not assemble the probe and tighten the feedthrough if the plant is under pressure.

The plant must not be vented by releasing the nut (A).

Use appropriate seal on conical probe threads.

Never rotate the screw connection body (B) but hold the screw connection body (B) securely and turn the nut (A).

Avoid unnecessary disassembly of pipe screw connections.

Position the cut in fitting >75 mm (>2.95") from the end of the filter cap to the end of the fitting!

For a probe length of 65 mm (2.56") a cut in fitting is not possible.

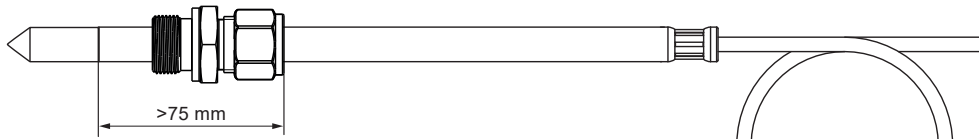
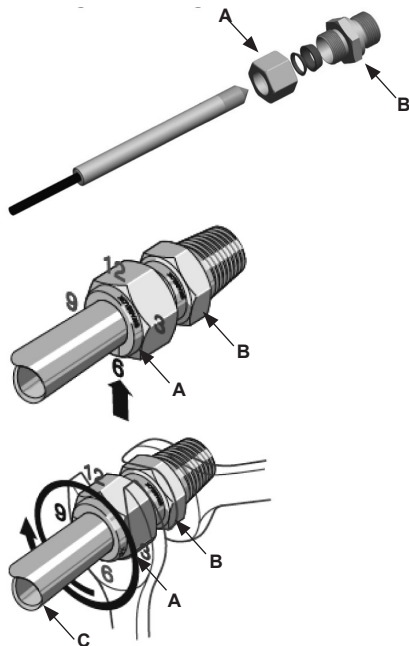

Fig. 30 Distance of cut-in fitting from probe tip

Installation instructions



- Tighten the nut (A) finger-tight.
- Mark the nut (A) at 6 o'clock position.
- Hold the screw connection body (B) tight and tighten the nut (A) with 1 ¼ turns till 9 o'clock position.

Assembly with high pressure applications and applications with a high security factor:

- Tighten the nut (A) until the probe (C) can no longer be turned by hand and moved axially in the feedthrough.
- Mark the nut (A) at 6 o'clock position.
- Hold the screw connection body (B) tight and tighten the nut (A) with 1 ¼ turns to 9 o'clock position.

Re-mounting:

- Slide the measurement probe with clamping ring into the fitting as far as it goes.
- Tighten the nut finger-tight, then tighten by approx. a ¼ turn using a spanner.

4.6 Remote Sensing Probes Type 40

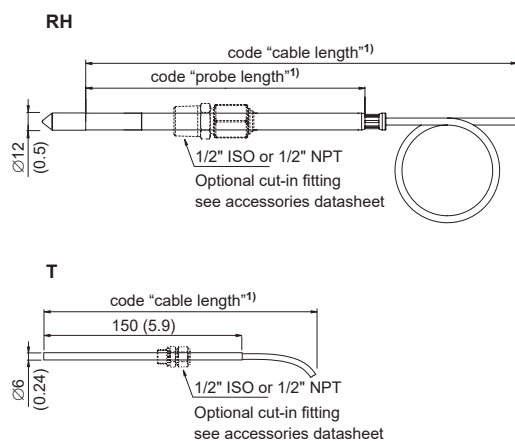

Fig. 31 Remote Sensing Probes Type 40

4.6.1. Installation at Normal Pressure

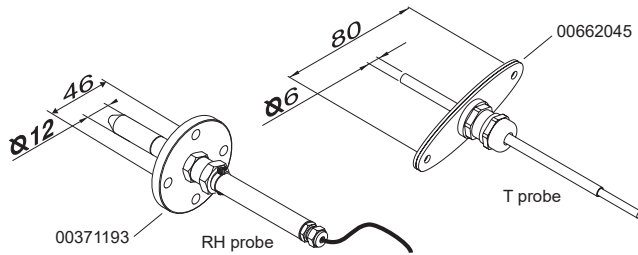

Fig. 32 Mounting of sensing probe with flange (accessory)

A mounting flange 12 mm (1/2") for the humidity probe and a mounting flange 6 mm (1/4") for the temperature probe are available as an accessory. The immersion depth is adjustable.

Material numbers:

	RH probe (12 mm (1/2"))	T probe (6 mm (1/4"))
Flange	00371193	00662045

4.6.2. Pressure-tight Installation

Mounting of sensing probe with screw connection (accessory)

A 1/2" ISO or a 1/2" NPT screw connection, respectively, is available as an accessory for mounting both sensing probes (6 mm (1/4") and 12 mm (1/2")).

Material numbers:

	RH probe (12 mm (1/2"))	T probe (6 mm (1/4"))
1/2" ISO	00529328	00675492
1/2" NPT	00529334	30067154

For mounting instructions please refer to chapter 4.6.2. Pressure-tight Installation.

5 Electrical Connection

NOTICE

The electrical installation of the hydroTRANS H50 shall be performed by qualified personnel only. Observe all applicable national and international requirements for the installation of electrical devices as well as for power supply according to EN 61140, class III (EU) and class 2 supply (North America).

WARNING

Incorrect installation, wiring or power supply may cause overheating and therefore personal injuries or damage to property.

For correct cabling of the device, always observe the presented wiring diagram for the product version used.

The manufacturer cannot be held responsible for personal injuries or damage to property as a result of incorrect handling, installation, wiring, power supply and maintenance of the device.

5.1 Electrical Connection and Wiring Overview

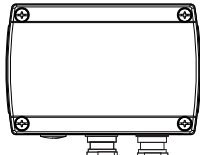
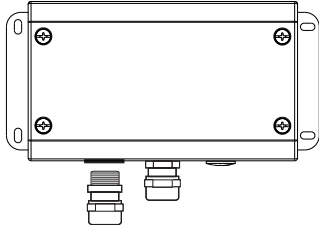
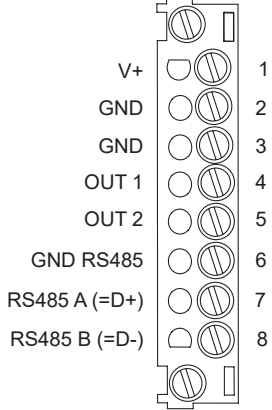
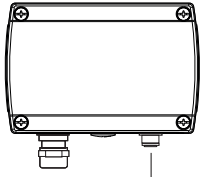
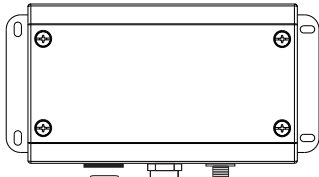
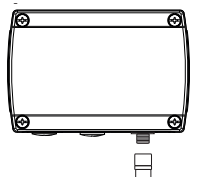
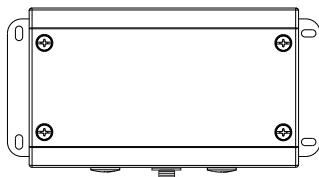
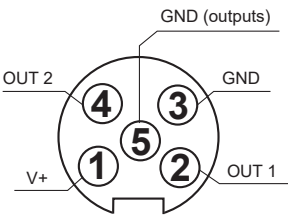
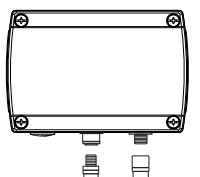
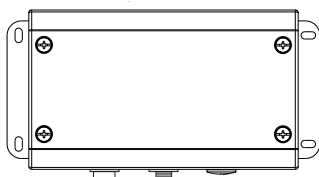
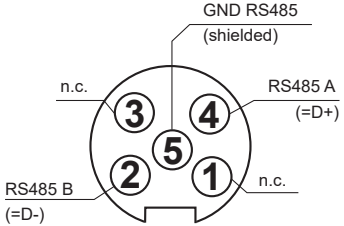
Option	Polycarbonate Enclosure	Stainless Steel Enclosure	Pin Assignment
Cable glands	 <p>2x M16x1.5</p>	 <p>1 x M16x1.5 mounted 1 x M16x1.5 enclosed</p>	 <p>V+ 1 GND 2 GND 3 OUT 1 4 OUT 2 5 GND RS485 6 RS485 A (=D+) 7 RS485 B (=D-) 8</p>
PoE	 <p>M12 X-coded socket, no connector in scope of supply.</p>	 <p>M12 X-coded socket, no connector in scope of supply.</p>	
4	 <p>Power supply + analogue output</p>	 <p>Power supply + analogue output</p>	 <p>GND (outputs) OUT 2 4 GND 3 V+ 1 OUT 1 2 Plug for power supply + analogue output</p>
6	 <p>Digital RS485 Interface Power supply + analogue output</p>	 <p>Digital RS485 Interface Power supply + analogue output</p>	 <p>GND RS485 (shielded) n.c. 3 RS485 A (=D+) 4 RS485 B (=D-) 2 5 1 n.c. Socket for Modbus RTU</p>

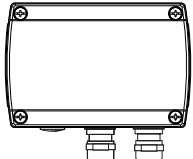
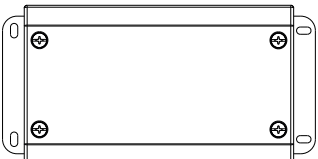
Option	Polycarbonate Enclosure	Stainless Steel Enclosure	Pin Assignment
Additional module option 2	 <p data-bbox="510 481 606 504">2x M16x1.5</p>	 <p data-bbox="877 526 973 548">2x M16x1.5</p>	<div data-bbox="1141 257 1484 571"> </div> <p data-bbox="1173 582 1460 616">Standard operation mode</p> <hr/> <div data-bbox="1141 683 1484 996"> </div> <p data-bbox="1181 1008 1452 1041">Inverted operation mode</p>

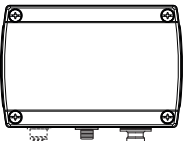
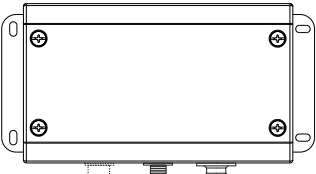
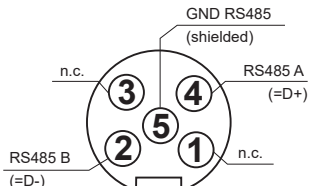
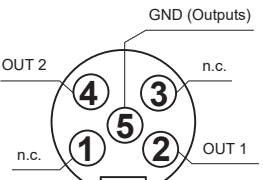
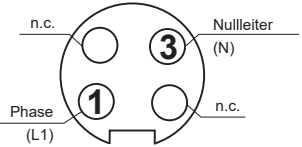
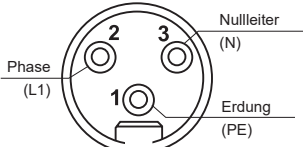
Option	Polycarbonate Enclosure	Stainless Steel Enclosure	Pin Assignment
AM3	 <p data-bbox="370 562 561 607">Modbus RTU (only with order code J3)</p> <p data-bbox="416 506 491 551">Analogue outputs</p> <p data-bbox="520 524 639 568">Power supply 100 - 240 V AC</p>	 <p data-bbox="758 636 954 680">Modbus RTU (only with order code J3)</p> <p data-bbox="834 577 909 622">Analogue outputs</p> <p data-bbox="938 595 1058 640">Power supply 100 - 240 V AC</p>	 <p data-bbox="1252 533 1364 577">Socket for Modbus RTU</p> <hr/>  <p data-bbox="1236 907 1380 952">Plug for analogue output</p> <hr/>  <p data-bbox="1149 1176 1476 1243">Stecker für Spannungsversorgung 100 - 240 V AC für Polycarbonat-Gehäuse</p> <hr/>  <p data-bbox="1141 1467 1476 1534">Stecker für Spannungsversorgung 100 - 240 V AC für Edelstahl-Gehäuse</p>

Tab. 4 Options for electrical connections and wiring

5.2 With Cable Glands

For cabling via the cable glands and direct electrical connection within the enclosure, the assignment of the screw terminals in the base module is as shown in Fig. 33.

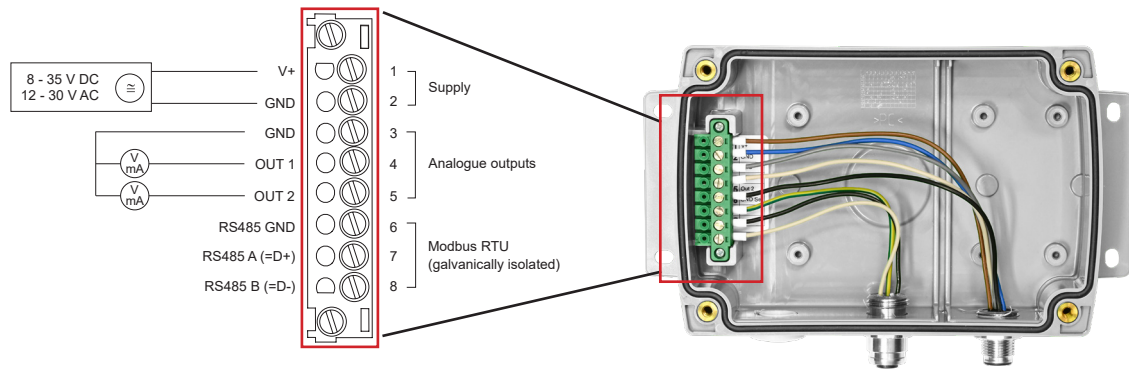
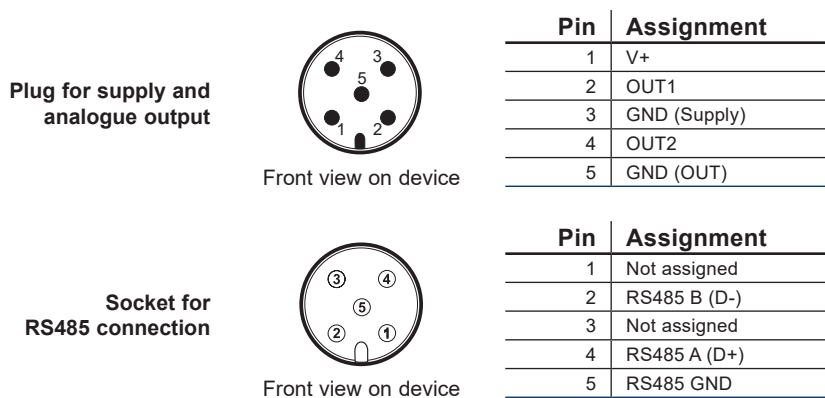

Fig. 33 Pin assignment on screw terminals for electrical connection via cable glands

5.3 Plug Options



i PLEASE NOTE

The cable(s) should be connected according to the number stamped in the plug as shown in the above drawings.

5.4 ARC Module (Additional Module Option 1)

Please refer to chapter 3.5.3. ARC Module (Additional Module Option 1).

5.5 Alarm Module (Additional Module Option 2)

⚠ WARNING

If the stainless steel enclosure is equipped with an alarm module (additional module option 2) or an integrated power supply 100 - 240 V AC (additional module option 3) and installation is not carried out correctly, there is the danger of a touch voltage.

The hydroTRANS H50's stainless steel enclosure must therefore be grounded during operation.

For the contact scheme in standard and inverted operation mode, please refer to Tab. 4 in chapter 5.1 Electrical Connection and Wiring Overview.

5.6 Integrated Power Supply 100 - 240 V AC (Additional Module Option 3)

⚠ WARNING

If the stainless steel enclosure is equipped with an alarm module (additional module option 2) or an integrated power supply 100 - 240 V AC (additional module option 3) and installation is not carried out correctly, there is the danger of a touch voltage.

The hydroTRANS H50's stainless steel enclosure must therefore be grounded during operation.

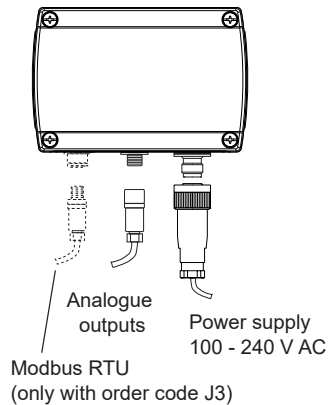

Fig. 34 Polycarbonate enclosure

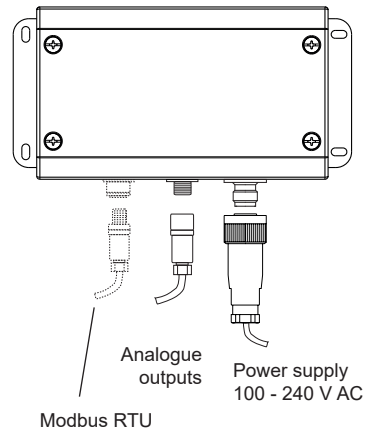

Fig. 35 Stainless steel enclosure

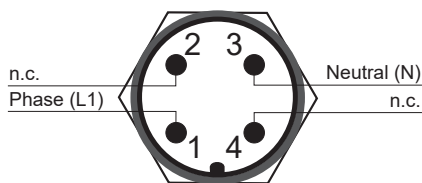

Fig. 36 Plug for power supply 100 - 240 V AC on polycarbonate enclosure, front view

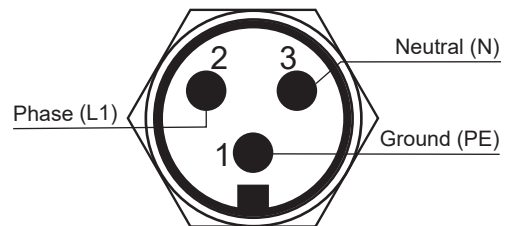

Fig. 37 Plug for power supply 100 - 240 V AC on stainless steel enclosure, front view

⚠ WARNING

Non-compliance to the following instructions can cause an electric shock with the risk of serious injury or death.

- The integrated power supply option includes a 1.25 A fuse on the 100 - 240 V side. This fuse may be replaced only by the after sales service.
- The protection of the supply cable against excess current and short-circuit must be designated to a wire cross section of 0.8 mm² (AWG 18) (6 A fuse).
- The metal enclosure must be grounded during operation.
- All national regulations for installation shall be observed!

NOTICE

External diameter of the supply cable for the integrated power supply option: 10...12 mm (0.39...0.47").

Maximum wire cross section for the integrated power supply option's connecting cable: 1.5 mm² (AWG 16).

External diameter of the cable for Modbus RTU and to the analogue output socket: 4...6 mm (0.16...0.24").

Maximum wire cross section for connecting cable: 0.5 mm² (AWG 21).

6 Setup and Configuration

The hydroTRANS H50 is ready to use and does not require any configuration by the user. The factory setup of hydroTRANS H50 corresponds to the type number ordered. Please refer to the data sheet at our [product website](#). If needed, the user can change the factory setup. This chapter describes the configuration possibilities of PCS Configuration Software and of the digital RS485 interface with Modbus RTU.

6.1 PCS Configuration Software

6.1.1. General

The PCS provides a convenient graphical user interface to the hydroTRANS H50 for changing the factory setup via a USB configuration cable (USB-C to USB-A, accessory material number 30067139). If the hydroTRANS H50 is connected to a PC via the USB interface, power is supplied via USB; an external power supply is not required.

NOTICE

Ensure that the device is only powered by the USB interface during firmware update, otherwise the update may fail. Otherwise, data integrity might not be provided during firmware download.

To use the software for adjustments and changes in settings, please proceed as follows:

1. Download the free PCS Configuration Software from our [product website](#) and install it on the PC.
2. Connect the hydroTRANS H50 to the PC using the USB cable. Refer to Fig. 38 and Fig. 39 below.
3. Start the PCS software.
4. Follow the instructions on the PCS opening page for scanning the ports and identifying the connected device.
5. Click on the desired setup or adjustment mode from the main PCS menu on the left. Follow the online instructions of the PCS which are displayed when clicking the "Tutorial" button.
6. Changes are uploaded to the probe by pressing the "Sync" button.



Fig. 38 USB service interface



Fig. 39 Plugged USB cable and LED indication

6.1.2. Analogue Outputs

Both analogue outputs shall be configured to either voltage or current. Measurands, analogue output range and scaling are freely selectable. All settings can be performed using the PCS Configuration Software or via display and push-buttons.

The analogue outputs feature an error indication function according to NAMUR NE43. In the case of an error the output signal will freeze at 21 mA or 11 V respectively.

i PLEASE NOTE

The error display is disabled by default.

The analogue outputs are both either current or voltage outputs. When changing one of the analogue outputs from current to voltage and vice versa, the second output will change automatically to this output type. The scaling changes automatically if it is out of physical range (i.e. 20 mA will be changed to 10 V instead of 20 V).

i PLEASE NOTE

Check output scale after changing between voltage and current output.

6.1.3. Simulation Mode

For the purpose of testing the measurement system, the RH and T output values can be fixed for a certain time. All calculated humidity related physical quantities are then based on these two arbitrarily set values.

The Simulation Mode can be set up and started with the PCS Configuration Software or via Modbus commands. The desired RH and T values have to be entered. The duration for which the values are valid has to be specified in seconds.

The Simulation Mode is available for all hydroTRANS H50 models.

6.1.4. Multipoint Adjustment

For the hydroTRANS H50, PCS offers the option of performing a multi-point adjustment for RH and/or T. The procedure can be used to correct the sensor deviations of the RH and/or T values at several points (min. 2, max. 10). With PCS, the user enters all reference values and the corresponding deviations of the device to be tested at each individual point. All entered data is taken into account for the correction.

6.1.5. Eventlog and Histograms

hydroTRANS H50 features RH and T histogram data and eventlog information readable via PCS to simplify communication with the customer service and to provide additional information on sensor status.

Eventlog

All important events (customer adjustments, detected errors, ARC cycles, ...) that have occurred during the sensor's lifetime are recorded in a permanent memory. The user can export the complete list with PCS and send it to the customer service.

This data cannot be deleted by the user.

Histogram data

The operating conditions under which the sensor has been used (RH and T for the probe, T for the main unit) are recorded in a permanent memory (since the sensor was first switched on).

Two types of histograms are available:

- Lifetime histogram:
Lists the data since the sensor was first switched on. The lifetime data cannot be deleted by the user.
- Analysis histogram:
Lists the data since the last time the recorded values were reset. A reset can be carried out by the user.

All histogram data can be exported and sent in to the customer service to simplify communication.

6.2 RS485 Digital Interface

6.2.1. Modbus RTU Setup

	Factory settings	Selectable values (via PCS)
Baud rate	9 600	9 600, 19 200, 38 400, 57 600, 76 800
Data bits	8	8
Parity	Even	None, odd, even
Stop bits	1	1, 2
Modbus address	230 (0xE6)	1...247

Tab. 5 Modbus RTU protocol settings

i PLEASE NOTE

- The recommended settings for multiple devices in a Modbus RTU network are 9 600, 8, even, 1.
- The hydroTRANS H50 represents 1 unit load on an RS485 network.

Device address, baud rate, parity and stop bits can be set via:

- PCS Configuration Software and the USB configuration cable 30067139.
The PCS can be downloaded free of charge from our [product website](#).
- Modbus protocol in the register 1 (0x00) and 2 (0x01).

The serial number as ASCII-code is located in read-only registers 1 - 8 (0x00 - 0x07).

The firmware version is located in read-only register 9 (0x08) (bit 15...8 = major release; bit 7...0 = minor release).

The sensor name as ASCII-code is located in read-only registers 10 - 17 (0x09 - 0x11).

NOTICE

When reading the serial number or the sensor name, it is always necessary to read all registers, even if the desired information requires less.

NOTICE

For obtaining the correct floating point values, both registers have to be read within the same reading cycle. The measured value can change between two Modbus requests, exponent and mantissa may get inconsistent then.

INFO

The Modbus function codes mentioned throughout this document shall be used as described in the MODBUS APPLICATION PROTOCOL SPECIFICATION V1.1b3, chapter 6:

www.modbus.org/docs/Modbus_Application_Protocol_V1_1b3.pdf

Device settings (INT16)

Parameter	Register number ¹⁾ [Dec]	Register address ²⁾ [Hex]	Size ³⁾
Write register: function code 0x06			
Modbus address	1	00	1
Modbus protocol settings	2	01	1
ARC trigger	509	1FC	1

Device information (INT16)

Parameter	Register number ¹⁾ [Dec]	Register address ²⁾ [Hex]	Size ³⁾
Read register: function code 0x03 / 0x04			
Serial number sensor (as ASCII)	1	00	8
Firmware version	9	08	1
Sensor name (as ASCII)	10	09	8
Serial number smart probe (as ASCII)	18	11	8
ARC remaining seconds	510	1FD	1
Device status	609	260	1
Module status	610	261	1
Device operating conditions	611	262	1

1) Register number (decimal) starts from 1.

2) Register address (hexadecimal) starts from 0.

3) Number of registers

Tab. 6 hydroTRANS H50 registers for device setup

To achieve maximum accuracy for the calculated humidity-related parameters, pressure compensation can be performed. The operating pressure at the operating point can be written to the 'Working pressure' register (5001-5002, 0x1388-0x1389) via Modbus command or with the PCS.

The hydroTRANS H50 features a simulation mode for temperature and relative humidity, please refer to chapter 6.1.3 Simulation Mode.

The user can set the simulated temperature and relative humidity values via PCS or using the registers 5902 (0x170D) and 5904 (0x170F). The simulation mode can be started via PCS or using the register 5901 (0x170C). For configuration, please refer to Tab. 7 below.

Application parameters

Parameter	Type	Register number ¹⁾ [Dec]	Register address ²⁾ [Hex]	Size ³⁾
Write register: function code 0x10 / read register: function code 0x03/04				
Working pressure	FLOAT32	5001	1388	2
Simulated temperature	FLOAT32	5902	170D	2
Simulated relative humidity	FLOAT32	5904	170F	2
Write register: function code 0x06 / read register: function code 0x03/04				
Simulation duration	UINT16	5901	170C	1

- 1) Register number starts from 1.
 2) Protocol address starts from 0.
 3) Number of registers

Tab. 7 hydroTRANS H50 application parameters

6.2.2. Modbus Register Map

The measured data is saved as 32 bit floating point values (data type FLOAT32) and as 16 bit signed integer values (data type INT16).

FLOAT32

Measurand	Unit	Register number ¹⁾ [DEC]	Register address ²⁾ [HEX]
Read register: function code 0x03 / 0x04			
Relative humidity	%	1021	3FC
Temperature	°C	1003	3EA
Temperature	°F	1005	3EC
Temperature	K	1009	3F0
Dew point temperature	°C	1105	450
Dew point temperature	°F	1107	452
Dew point temperature	K	1147	47A
Frost point temperature	°C	1131	46A
Frost point temperature	°F	1133	46C
Frost point temperature	K	1149	47C
Absolute humidity	g/m ³	1113	458
Absolute humidity	gr/ft ³	1115	45A
Mixing ratio	g/kg	1121	460
Mixing ratio	gr/lb	1123	462
Wet bulb temperature	°C	1109	454
Wet bulb temperature	°F	1111	456
Wet bulb temperature	K	1145	478
Specific enthalpy	kJ/kg	1125	464
Specific enthalpy	BTU/lb	1129	468
Specific enthalpy	ft lbf/lb	1127	466
Water vapour partial pressure	mbar	1101	44C
Water vapour partial pressure	psi	1103	44E
Ice bulb temperature	°C	1237	4D4
Ice bulb temperature	°F	1239	4D6
Ice bulb temperature	K	1241	4D8
Specific humidity	g/kg	1247	4DE
Specific humidity	gr/lb	1249	4E0

- 1) Register number starts from 1
 2) Register address starts from 0

Tab. 8 hydroTRANS H50 FLOAT32 measured data registers

INT16

Measurand	Unit	Scale ³⁾	Register number ¹⁾ [DEC]	Register address ²⁾ [HEX]
Read register: function code 0x03 / 0x04				
Relative humidity	%	100	4011	FAA
Temperature	°C	100	4002	FA1
Temperature	°F	50	4003	FA2
Temperature	K	50	4005	FA4
Dew point temperature	°C	100	4053	FD4
Dew point temperature	°F	100	4054	FD5
Dew point temperature	K	100	4074	FE9
Frost point temperature	°C	100	4066	FE1
Frost point temperature	°F	100	4067	FE2
Frost point temperature	K	100	4075	FEA
Absolute humidity	g/m ³	10	4057	FD8
Absolute humidity	gr/ft ³	10	4058	FD9
Mixing ratio	g/kg	10	4061	FDC
Mixing ratio	gr/lb	10	4062	FDD
Wet bulb temperature	°C	100	4055	FD6
Wet bulb temperature	°F	100	4056	FD7
Wet bulb temperature	K	100	4073	FE8
Specific enthalpy	kJ/kg	1	4063	FDE
Specific enthalpy	BTU/lb	1	4064	FDF
Specific enthalpy	ft lbf/lb	1	4065	FE0
Water vapour partial pressure	mbar	10	4051	FD2
Water vapour partial pressure	psi	1000	4052	FD3
Ice bulb temperature	°C	100	4119	1016
Ice bulb temperature	°F	100	4120	1017
Ice bulb temperature	K	50	4121	1018
Specific humidity	g/kg	10	4124	101B
Specific humidity	gr/lb	10	4125	101C

1) Register number starts from 1

2) Register address starts from 0

3) Examples: For scale 100, the reading of 2550 means a value of 25.5. For scale 50, the reading of 2550 means a value of 51.

Tab. 9 hydroTRANS H50 INT16 measured data registers

6.2.3. Freely Configurable Custom Modbus Map

Important measured value / status registers can be arbitrarily mapped to a block of up to 20 consecutive registers. These selected registers can then be read out with a single Modbus query in one block.

The custom map can be configured via:

- PCS Configuration Software 30068830 and the USB configuration cable 30067139.
The PCS can be downloaded free of charge from our [product website](#).
- Modbus protocol commands, refer to the example in chapter 6.3 Modbus RTU Example.

The register block for the configuration of the customisable Modbus map consists of the registers 6001 (0x1770) to 6010 (0x1779). For the blockwise query of the measured values behind Modbus registers 3001 (0xBB8) to 3020 (0xBCB), the firmware accesses this configuration area and thus gets the information which measured value/status registers are to be output. A maximum of 10 user-defined registers can be mapped. The table below shows an example:

Registers with these assigned measurands map to registers mirrored from source registers	
Dec	Hex	Meas.	Unit	Type	Dec	Hex	Dec	Hex
<i>Function code 0x10</i>					<i>Function code 0x03/0x04</i>			
6001	0x1770	RH	%	FLOAT32	3001	0xBB8	1021	0x3FC
				FLOAT32	3002	0xBB9	1022	0x3FD
6002	0x1771	T	°C	FLOAT32	3003	0xBBA	1003	0x3EA
				FLOAT32	3004	0xBBB	1004	0x3EB
6003	0x1772	Td	°C	FLOAT32	3005	0BBC	1105	0x450
				FLOAT32	3006	0xBBD	1106	0x451
6004	0x1773	Tw	°C	FLOAT32	3007	0BBE	1109	0x454
				FLOAT32	3008	0BBF	1110	0x455
6005	0x1774	T	°F	FLOAT32	3009	0xBC0	1005	0x3EC
				FLOAT32	3010	0xBC1	1006	0x3ED
6006	0x1775	Td	°F	FLOAT32	3011	0xBC2	1107	0x452
				FLOAT32	3012	0xBC3	1108	0x453
6007	0x1776	RH	%	INT16	3013	0xBC4	4011	0xFAA
6008	0x1777	T	°C	INT16	3014	0xBC5	4002	0xFA1
6009	0x1778	T	°F	INT16	3015	0xBC6	4003	0xFA2
					3016	0xBC7	65536	0xFFFF
					3017	0xBC8	65536	0xFFFF
					3018	0xBC9	65536	0xFFFF
					3019	0xBCA	65536	0xFFFF
					3020	0xBCB	65536	0xFFFF

Tab. 10 Custom Modbus map example

6.2.4. Device Status Indication

If a critical error occurs, all Modbus values are set to NaN (according to IEEE754 for data type FLOAT32) or to 0x8000 (INT16). It is possible to read out all status and error information via Modbus register 609 (0x260). Errors are displayed in bit-coded form. If an event is present, the corresponding bit is set to 1.

Measured values outside the measuring range are limited with the corresponding limit value.

Error Bits	Description	Recommended action
Bit 0	RH sensor shortcut	Return the unit to the Customer Service
Bit 1	RH sensor broken	Return the unit to the Customer Service
Bit 2	T sensor shortcut	Return the unit to the Customer Service
Bit 3	T sensor broken	Return the unit to the Customer Service
Bit 4	PT1000 sensor shortcut (probe type 40 only)	Return the unit to the Customer Service
Bit 5	PT1000 sensor broken (probe type 40 only)	Return the unit to the Customer Service
Bit 6	Tube heater failure	Return the unit to the Customer Service
Bit 7	RH sensor contamination (little bit)	Clean the RH sensing element
Bit 8	RH sensor contamination (dirty)	Clean the RH sensing element
Bit 9	RH sensor contamination (very dirty)	Return the unit to the Customer Service
Bit 10	Parallel capacity misconfiguration	Return the unit to the Customer Service
Bit 11	Analogue voltage output 1 shortcut	Check wiring
Bit 12	Analogue voltage output 2 shortcut	Check wiring
Bit 13	Analogue current output 1 open loop	Check wiring
Bit 14	Analogue current output 2 open loop	Check wiring
Bit 15	-	-

Tab. 11 Device status indication

6.2.5. Module Status Indication

If a critical error occurs, all Modbus values are set to NaN (according to IEEE754 for data type FLOAT32) or to 0x8000 (INT16). It is possible to read out the module status information via Modbus register 610 (0x261). Status indication is bit-coded. If an event is present, the corresponding bit is set to 1.

Measured values outside the measuring range are limited with the corresponding limit value.

Error Bits	Description	Recommended action
Bit 0	Display communication error	Return the unit to the Customer Service
Bit 1	Ext. module communication error (Additional module option 1 or 2, digital interface option 4)	Return the unit to the Customer Service
Bit 2	-	-
Bit 3	-	-
Bit 4	-	-
Bit 5	-	-
Bit 6	-	-
Bit 7	-	-
Bit 8	ARC active	None
Bit 9	CG active	None
Bit 10	-	-
Bit 11	-	-
Bit 12	-	-
Bit 13	-	-
Bit 14	-	-
Bit 15	-	-

Tab. 12 Module status indication

6.2.6. Device Operating Conditions Indication

If a critical error occurs, all Modbus values are set to NaN (according to IEEE754 for data type FLOAT32) or to 0x8000 (INT16). It is possible to retrieve device operating conditions information from Modbus register 611 (0x262). Errors are displayed in bit-coded form. If an event is present, the corresponding bit is set to 1.

Measured values outside the measuring range are limited with the corresponding limit value.

Event Bits	Description	Recommended action
Bit 0	PCB temperature too low	Check temperature at installation point
Bit 1	PCB temperature too high	Check temperature at installation point
Bit 2	T value too low	Check process temperature
Bit 3	T value too high	Check process temperature
Bit 4	PT1000 value too low (probe type 40 only)	Check process temperature
Bit 5	PT1000 value too high (probe type 40 only)	Check process temperature
Bit 6	RH sensor too dry	Check process humidity
Bit 7	RH sensor condensation	Check process humidity
Bit 8	-	-
Bit 9	-	-
Bit 10	-	-
Bit 11	-	-
Bit 12	-	-
Bit 13	-	-
Bit 14	-	-
Bit 15	-	-

Tab. 13 Device operating conditions indication

6.2.7. Retrofit with RS485 Module

hydroTRANS H50 can be retrofitted with an RS485 module. Before retrofitting, please make sure that the device firmware is updated to the latest version by using PCS. Please observe the instructions in the quick guide of the retrofit module.

The RS485 module is automatically detected by hydroTRANS H50 at power on. Module setup can be performed via PCS Configuration Software or via display and push-buttons.

The module is available as an accessory (material number 30067193).

6.3 Modbus RTU Example

The hydroTRANS H50's Modbus address is 230 [0xE6].

Please refer to MODBUS APPLICATION PROTOCOL SPECIFICATION V1.1b3, chapter 6:
www.modbus.org/docs/Modbus_Application_Protocol_V1_1b3.pdf

Read the temperature (FLOAT32) T = 25.6787014007568359375 °C from register address 0x3EA:

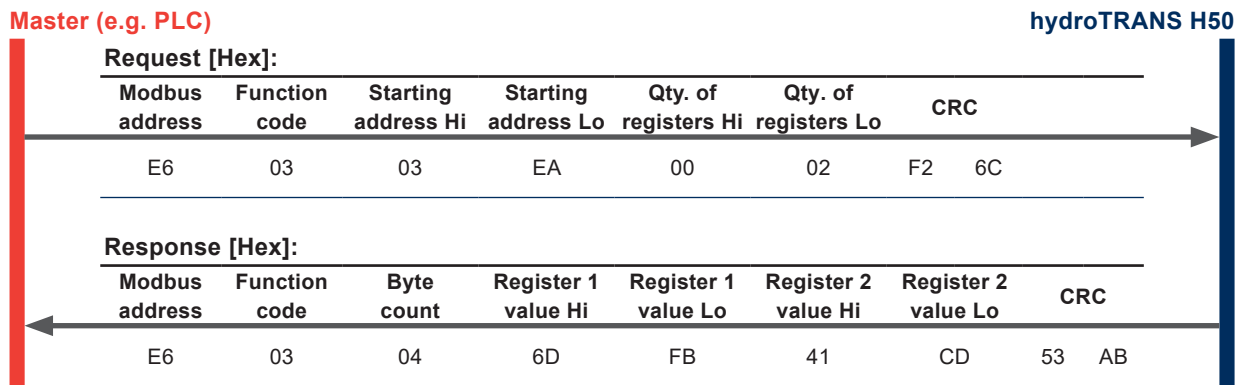

Tab. 14 Example temperature query

Decoding of floating point values:

Floating point values are stored according to IEEE754. The byte pairs 1, 2 and 3, 4 are transformed as follows (numbers taken from T reading Modbus request/response example above):

Modbus response [Hex]			
Register 1 Hi	Register 1 Lo	Register 2 Hi	Register 2 Lo
6D	FB	41	CD
MMMMMMMM	MMMMMMMM	SEEEEEEE	EMMMMMMM

Tab. 15 Modbus response

IEEE754			
Register 2 Hi	Register 2 Lo	Register 1 Hi	Register 1 Lo
41	CD	6D	FB
0100 0001	1100 1101	0110 1101	1111 1011
SEEE EEEE	EMMM MMMM	MMMM MMMM	MMMM MMMM
Decimal value: 25.6787014007568359375			

Tab. 16 Data representation according to IEEE754

7 Maintenance and Service

7.1 Self Diagnosis and Error Messages

7.1.1. Error Messages on the Display

Error Description	Error Code (Display)	Error Category	Recommended Action
Voltage out short circuit - output 1 only*	1.x	1	Check the wiring of the outputs
Current loop open - output 1 only	2.x		Check the wiring of the outputs
RH sensor polluted	3.x		Clean the sensor
Hardware error	5.x	2	Return the faulty unit to the manufacturer for service
	6.x		
	8.x		
Temperature measurement failure	7.x		
Humidity measurement failure	9.x		
	10.x		

For all other error codes occurring on the display, please contact the service team.

* not available with 0 - 1 V output

Tab. 17 Overview of error codes

Error Category	Description
1	<p>Non-critical error, can be solved by the user.</p> <ul style="list-style-type: none"> The display blinks and the buzzer beeps every 10 seconds. The red status LED lights continuously.
2	<p>Critical error, return the device to the manufacturer for service.</p> <ul style="list-style-type: none"> The display blinks and the buzzer beeps continuously. The red status LED flashes.

Tab. 18 Explanation of the error category

7.1.2. Status and Error Messages via LEDs

Four status LEDs are placed on both sides of the PCB next to the USB service interface. The USB connector is accessible after removing the blind cover.

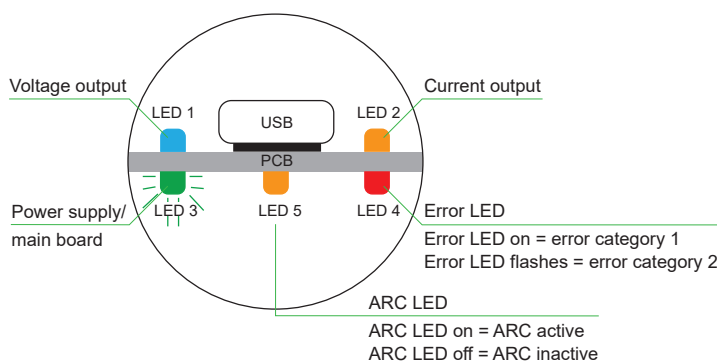

Fig. 40 Status LEDs

LED (colour)	Description
1 (blue)	Analogue output one set to voltage.
2 (orange)	Analogue output one set to current.
3 (flashing green)	Supply voltage applied (microprocessor is active).
4 (red)	permanently lit flashes Error category 1 Error category 2
5 (orange)	ARC status

Tab. 19 Explanation of the LED colors

7.2 Cleaning the Sensing Head and Filter Cap Replacement

In case of dusty, oily and polluted environment

- The filter cap shall be replaced once in a while with an original one. A polluted filter cap causes longer response time of the device.
- If needed, the sensing head can be cleaned. For cleaning instructions please see our [product website](#).

7.3 Automatic ReCovery (ARC)

When capacitive humidity sensors are exposed to chemical pollution (e.g. detergent residue), the presence of foreign molecules can distort the measurement reading.

The foreign molecules can be evaporated by heating the measurement cell briefly and intensively. Reconditioning helps to minimize distorted measurement readings during the calibration interval.

It is recommended to heat the measurement cell manually after the cleaning or sterilization process or if distorted measurement readings are suspected. Trigger the ARC-module with the external signal (see chapter 3.5.3. ARC Module (Additional Module Option 1)).

i PLEASE NOTE

Before a recalibration is done after an ARC cycle, reconditioning of the sensing element is recommended. For best reconditioning, please allow 2 free calibration cycles between 15 %RH and 90 %RH in steps of ~20 %RH and 20 min stabilisation time.

7.4 RH and T Calibration and Adjustment

Humidity calibration and adjustment

Depending on the application and the requirements of certain industries, there might arise the need for periodical humidity calibration (comparison with a reference) or adjustment (bringing the device in line with a reference).

Calibration and/or adjustment can be performed by the manufacturer or by the user.

Perform offset or 2-point adjustment via display and push-buttons or via PCS Configuration Software (see below).

Additionally, the hydroTRANS H50 can be adjusted in multiple points (min. 2, max. 10) for RH and T using PCS. Please refer to chapter 6.1.4. Multipoint Adjustment.

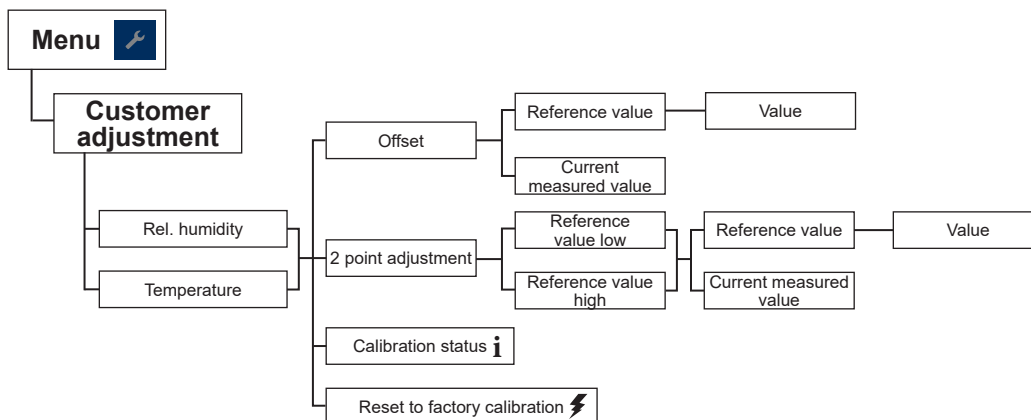

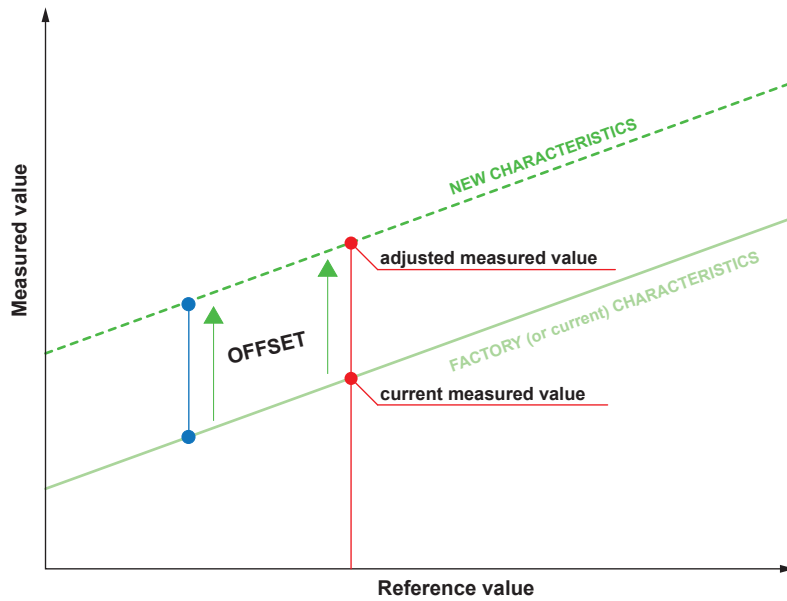

Fig. 42 1-point adjustment (offset)

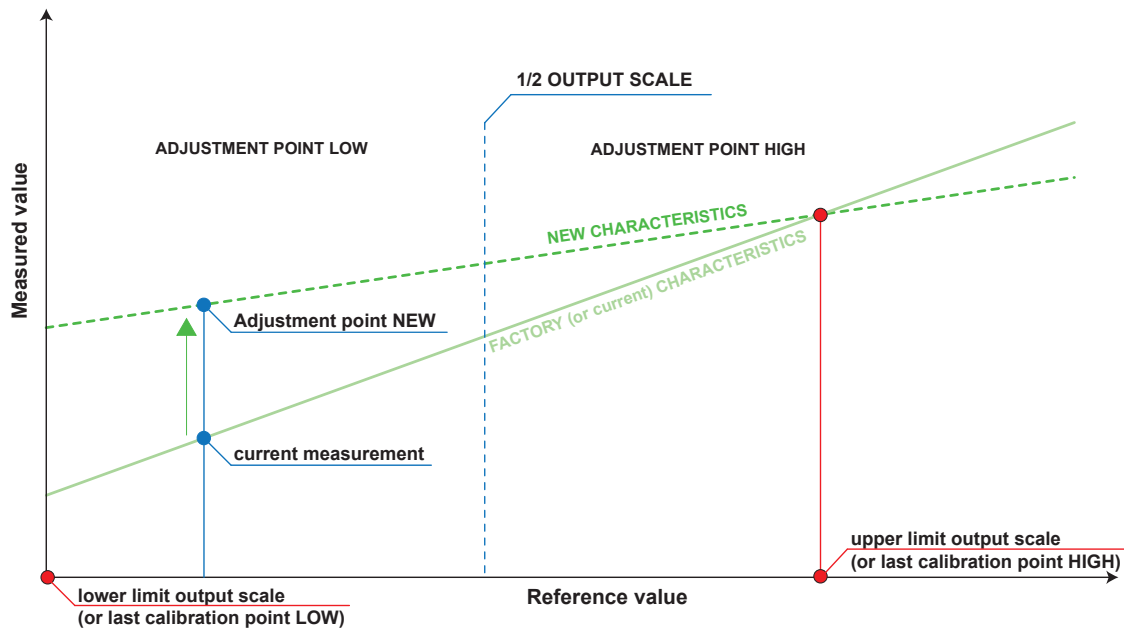

Fig. 43 2-point adjustment procedure

7.4.1. RH and T Adjustment and Calibration for Types 10 / 20 / 30

i PLEASE NOTE

Before adjusting or calibrating an hydroTRANS H50 with CG option (types 10 / 20 / 30), the CG function must be deactivated. Otherwise, the heating may start during adjustment/calibration and the outputs may freeze.

The CG function can be deactivated either via PCS or the optional display.

i PLEASE NOTE

Reactivate the CG function after adjustment/calibration to ensure proper functioning of the unit.

7.4.2. RH and T Adjustment and Calibration for Probe Type 40

The hydroTRANS H50 with probe type 40 has a dual heating system with two probes to prevent condensation on both the RH sensing element and the probe body through a controlled heating strategy. This results in a very short response time and fast recovery after condensation. In addition, it enables accurate measurement of relative humidity even in continuously high humidity and condensing conditions.

PLEASE NOTE

Before adjusting or calibrating an hydroTRANS H50 with remote probe type 40, the probe heating must be deactivated. Otherwise, the probe heating will affect the stability of the adjustment / calibration.

The probe heating can be deactivated either via PCS or the optional display.

PLEASE NOTE

When RH adjusting / calibrating a hydroTRANS H50 with remote probe type 40, it is of utmost importance to keep the RH and T probes at the same temperature.

PLEASE NOTE

The best adjustment results are achieved when a T adjustment is made first, followed by an RH adjustment.

PLEASE NOTE

Remember to reactivate the probe heating after adjustment / calibration to ensure proper functioning of the unit.

7.5 Fuse Replacement for Integrated Power Supply 100 - 240 V AC (Additional Module Option 3)

WARNING

The additional module option 3 includes a 1.25 A fuse on the 100 - 240 V side. This fuse may not be replaced by the user, only by the after sales service.

The protection of the supply cable against excess current and short-circuit must be designated to a wire cross section of 0.8 mm² (AWG 18) (6A fuse).

WARNING

There is the risk of electric stroke and subsequential serious injury or death.

- The metal enclosure must be grounded during operation.
 - All national regulations for installation shall be observed!
-

8 Ordering Guide hydroTRANS H50 Smart Probe

The Smart Probe can only be connected if probe connection option 7 has been selected.

Feature	Description	Code		
		907056		
Type	Remote probe up to 180 °C (356 °F)	10		
	Medium pressure up to 20 bar (300 psi) and 180 °C (356 °F)		20	
	RH remote probe, pressure-tight up to 20 bar (290 psi) and 180 °C (356 °F)			40
Filter	Stainless steel sintered	4	4	
	PTFE (Polytetrafluoroethylene)	5	5	5
	Stainless steel grid, stainless steel body (180 °C / 356 °F)	9	9	9
	PTFE membrane, stainless steel body			8
Probe cable length	2 m (6.6 ft)	02	02	02
	5 m (16.4 ft)	05	05	05
	10 m (32.8 ft)	10	10	10
Probe length	65 mm (2.56")	065		065
	80 mm (3.15")		080	
	200 mm (7.87")	200	200	200
	400 mm (15.75")	400	400	400
Process connection	G1/2" ISO - sliding fitting, Ø13 mm (0.51")		23	
	1/2" NPT - sliding fitting, Ø13 mm (0.51")		25	

9 Technical Data

Measurands

Relative Humidity (RH)

Measuring range	0...100 %RH
Accuracy ¹⁾ , incl. hysteresis, non-linearity and repeatability	±(0.95 + 0.0013 * mv) %RH ±1.8 %RH ±(1.05 + 0.0084 * mv) %RH ±(1.15 + 0.013 * mv) %RH ±3.85 %RH mv = measured value
Factory calibration uncertainty ²⁾	±(0.7 + 0.003 * mv) %RH ±1 %RH mv = measured value
Temperature dependency of electronics, typ.	±0.01 % RH / °C (0.0056 %RH / °F)
Response time t ₉₀ with metal grid filter at 20 °C (68 °F)	<15 s



1) Defined against calibration reference.

2) Defined at 23 °C with an coverage factor k=2, corresponding to a confidence level of 95 %.

Digital

Digital interface Protocol Factory settings Supported Baud rates	RS485 (hydroTRANS H50 = 1 unit load) Modbus RTU 9 600 Baud, parity even, 1 stop bit, Modbus address 230 9 600, 19 200, 38 400, 57 600 and 76 800
Digital interface Electrical connection Protocol Factory settings	Ethernet-PoE M12 X-coded, socket, IEEE 802.3af, class 1 or higher Modbus TCP IP address 192.168.0.64 (static)

General

Power supply class III  USA & Canada: Class 2 supply necessary, max. voltage 30 V DC	8 - 35 V DC 12 - 30 V AC 100 - 240 V AC, 50/60 Hz with integrated power supply option ¹⁾ PoE with digital interface option 4
Current consumption, (typ.) @ 24 V DC / AC 2 voltage outputs 2 current outputs additionally for display additionally for Ethernet	40 mA / 80 mA _{rms} 80 mA / 160 mA _{rms} 50 mA / 150 mA _{rms} 30 mA / 90 mA _{rms}
Electrical connection	Screw terminals max. 1.5 mm ² (AWG 16)
Cable glands for polycarbonate enclosure for metal enclosure	M16x1.5, for cable Ø3...7 mm (0.12...0.28") M16x1.5, for cable Ø4.5...10 mm (0.18...0.39")
Pressure range for pressure-tight probe Probe type 20 / 40 Probe type 30	0.01...20 bar (0.15...300 psi) 0.01...300 bar (0.15...4 350 psi)
Temperature range electronics board operation and storage without display with display	-40...+60 °C (-40...+140 °F) -20...+50 °C (-4...+122 °F)
Probe body Material Protection rating	Stainless steel 1.4404 / AISI 316L IP65
Enclosure Material Protection rating	Polycarbonate, UL94 V-0 approved or Stainless steel 1.4404 / AISI 316 L IP65 / NEMA 4X
Electromagnetic compatibility	EN 61326-1 EN 61326-2-3 Industrial Environment FCC Part15 ClassA ICES-003 ClassA
Conformity	 
Configuration Software Interface	PCS Configuration Software 30068830 (free download from our product website) USB-C, configuration cable 30067139

1) Appropriate for outdoor use, wet location, degree of pollution 2, overvoltage category II, altitude up to 3 000 m (9 843 ft)

Accuracy of JUMO Humidity and Temperature Sensors

The measurement accuracy depends both on the performance of the measuring instrument and on the correct installation in the application.

For best accuracy, every RH and T sensor is multipoint factory adjusted and calibrated in a highly stable RH / T reactor. Using a high-precision dew point mirror as reference, the overall uncertainty of the factory calibration U_{cal} is minimal.

The total measurement uncertainty U_{total} for sensors is calculated in accordance with EA-4/02 (European Accreditation, Evaluation of the Measurement Uncertainty in Calibration) and with GUM (Guide to the Expression of Uncertainty in Measurement) as follows:

$$U_{\text{total}} = k \cdot \sqrt{\left(\frac{U_{\text{cal}}}{2}\right)^2 + \left(\frac{u_{\text{accuracy}}}{\sqrt{3}}\right)^2}$$

U_{total} total accuracy incl. factory calibration

U_{cal} the uncertainty of the factory calibration

u_{accuracy} the accuracy of the measurement device

k coverage factor $k=2$, corresponding to a confidence level of 95 %.

For external calibrations, U_{total} is to be used as the evaluation criterion. The calculation does not include effects due to long-term drift or chemical exposure.

10 Conformity

10.1 Declarations of Conformity

JUMO GmbH & Co. KG. hereby declares that the product complies with the respective regulations listed below:



European directives and standards.

and



UK statutory instruments and designated standards.

Please refer to the product page at our [product website](#) for the Declarations of Conformity.

10.2 FCC Part 15 Compliance Statement

This equipment has been tested and found to comply with the limits for a Class A digital device, pursuant to part 15 of the FCC Rules. These limits are designed to provide reasonable protection against harmful interference when the equipment is operated in a commercial environment. This equipment generates, uses, and can radiate radio frequency energy and, if not installed and used in accordance with the instruction manual, may cause harmful interference to radio communications. Operation of this equipment in a residential area is likely to cause harmful interference in which case the user will be required to correct the interference at his own expense.

10.3 ICES-003 Compliance Statement

This Class A digital apparatus complies with Canadian ICES-003.

Cet appareil numérique de la classe A est conforme à la norme NMB-003 du Canada.

11 Appendix: Display Menu Structure

11.1 Overview

Menu 

Data logging	Configuration of the data logger/graph - sampling rate graphs
Display settings	Display layout - measurands brightness display alarm orientation
Analog output	Output configuration - mode measurands scaling error indication
Heating mode settings	ARC and CG configuration - activation deactivation parameters
Alarm output*	Relay configuration - mode set points state
Customer adjustment	Adjustment - 1 and 2 point humidity/temperature adjustment reset to factory adjustment calibration status
Modbus settings*	Configuration of Modbus RTU data transmission
IP settings*	Configuration of Ethernet module
Device settings	Settings - language date, time parameters password protection
Status	Status and device information

* Menu only available with the corresponding optional module.

Fig. 44 Menu overview

11.2 Detailed Information

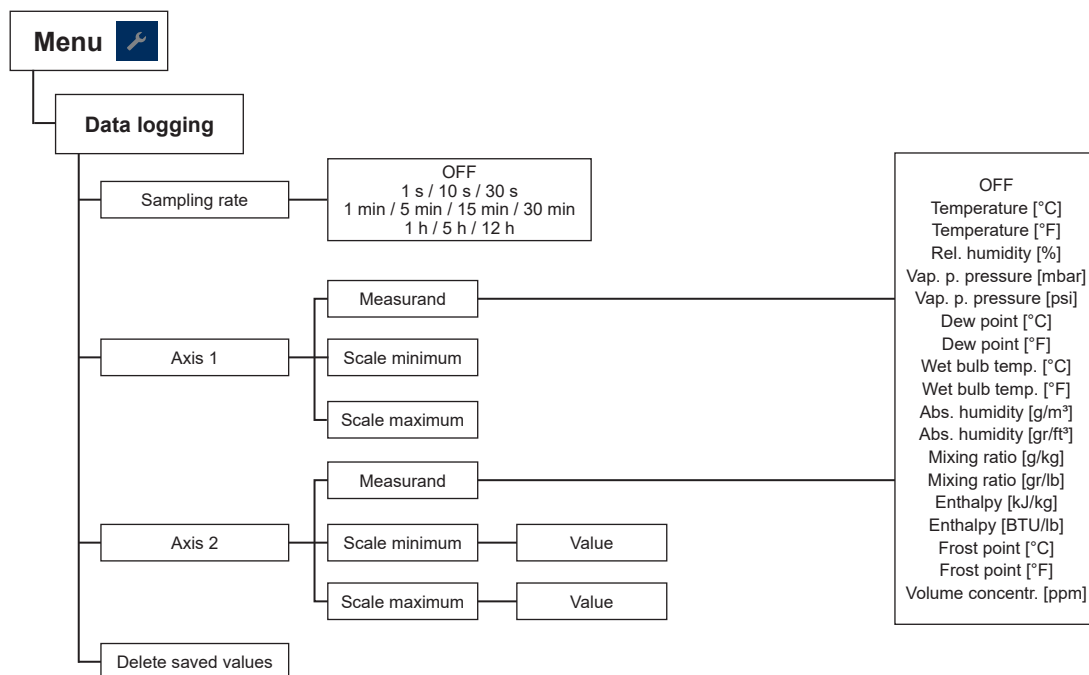

Fig. 45 Data logging

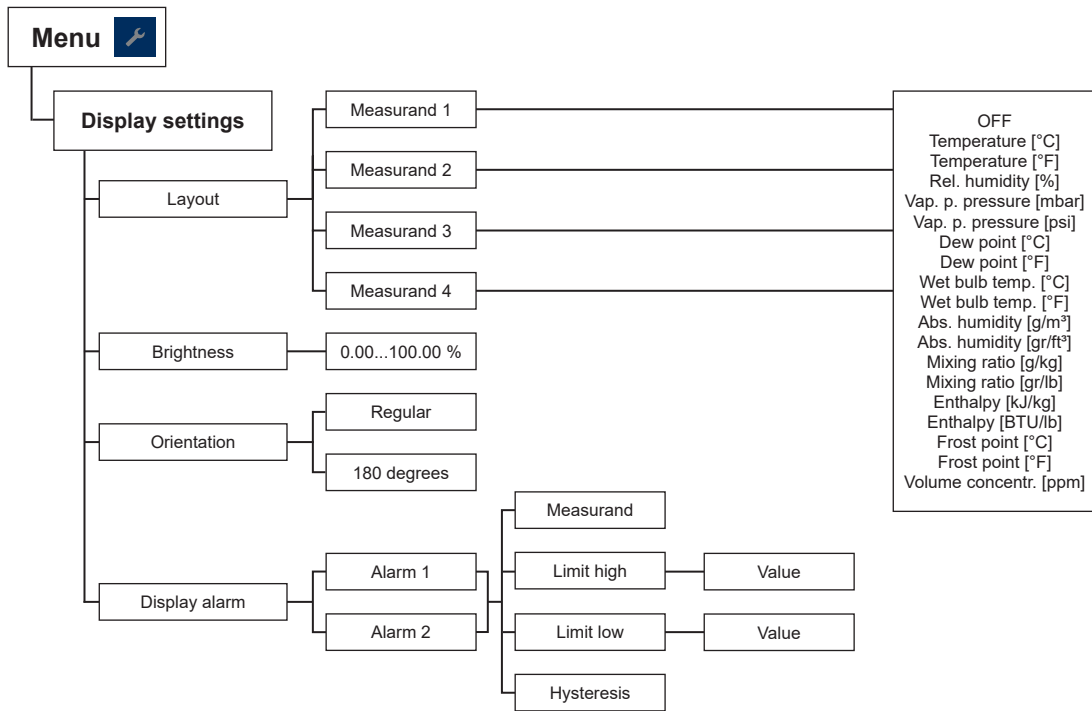

Fig. 46 Display settings

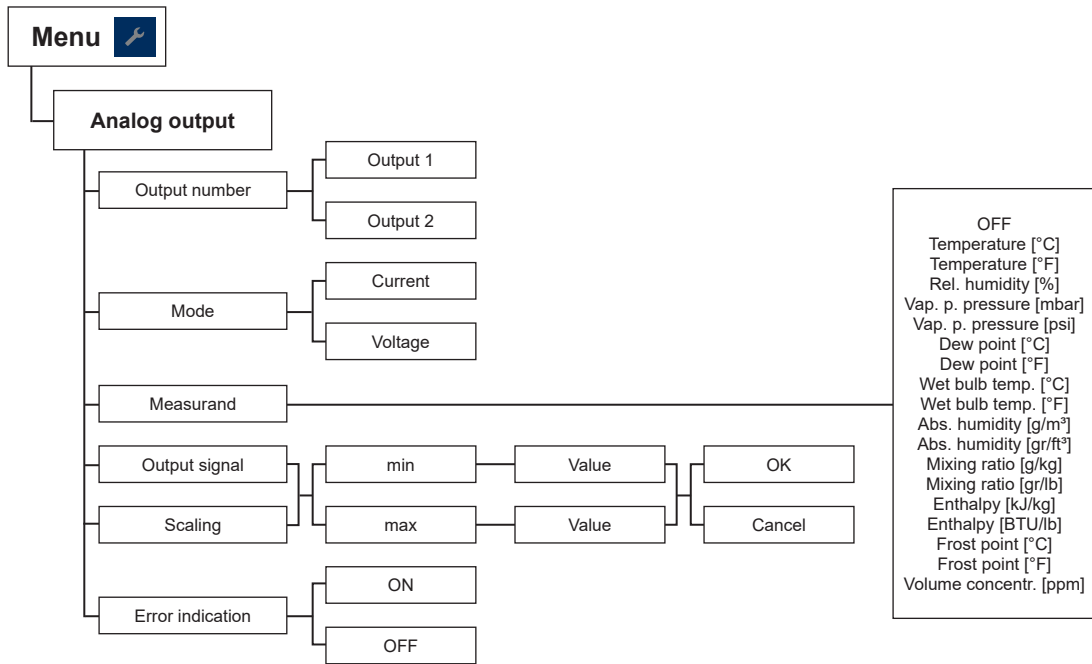

Fig. 47 Analogue output

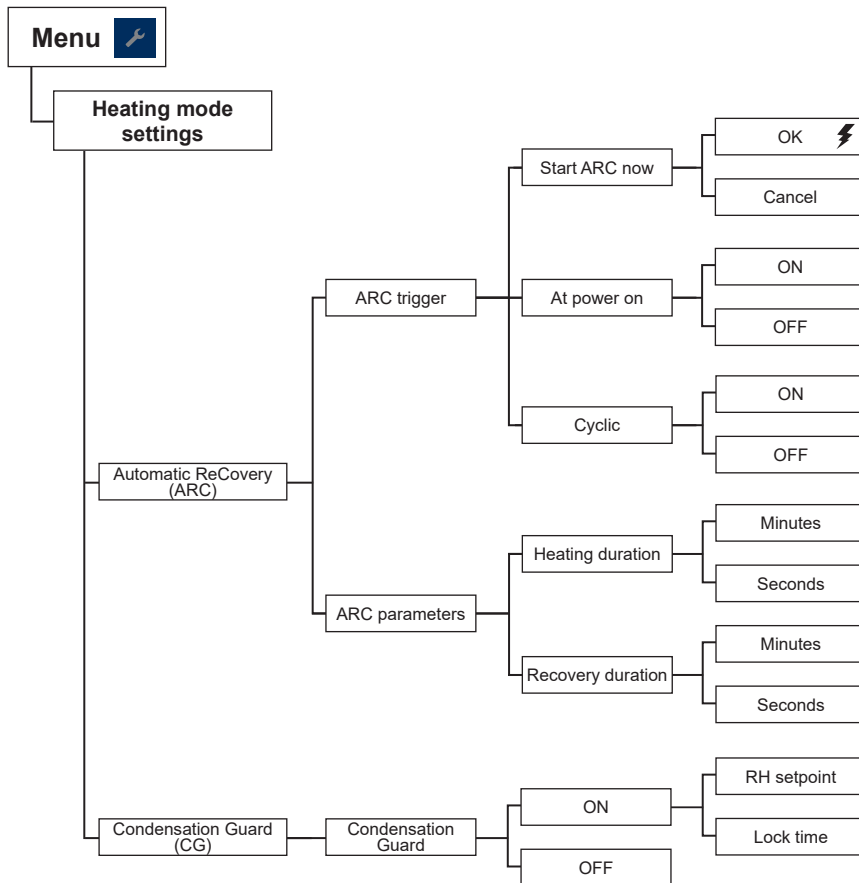

Fig. 48 Heating mode settings

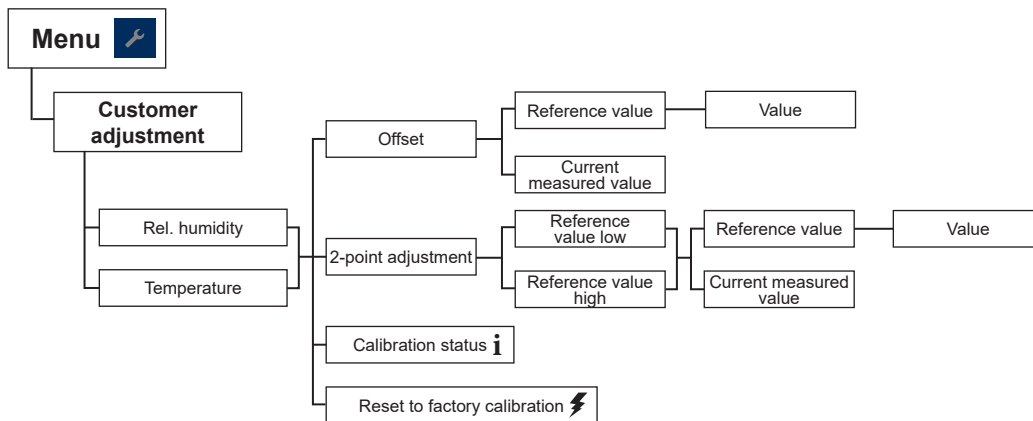
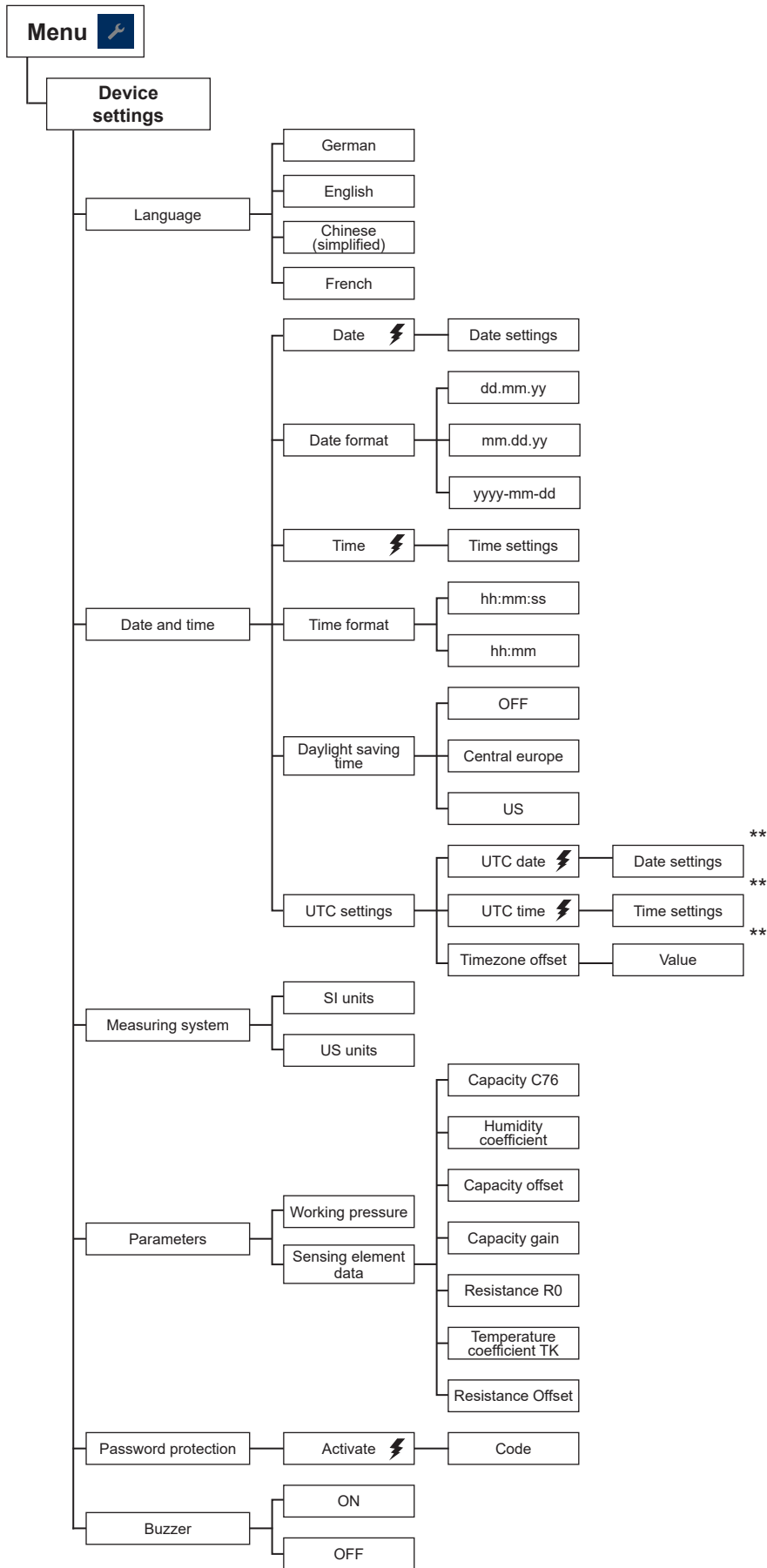

Fig. 49 Customer adjustment



** Changing the UTC time will delete measurement data!

Fig. 50 Device settings

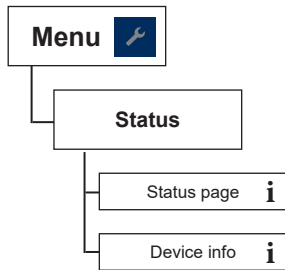
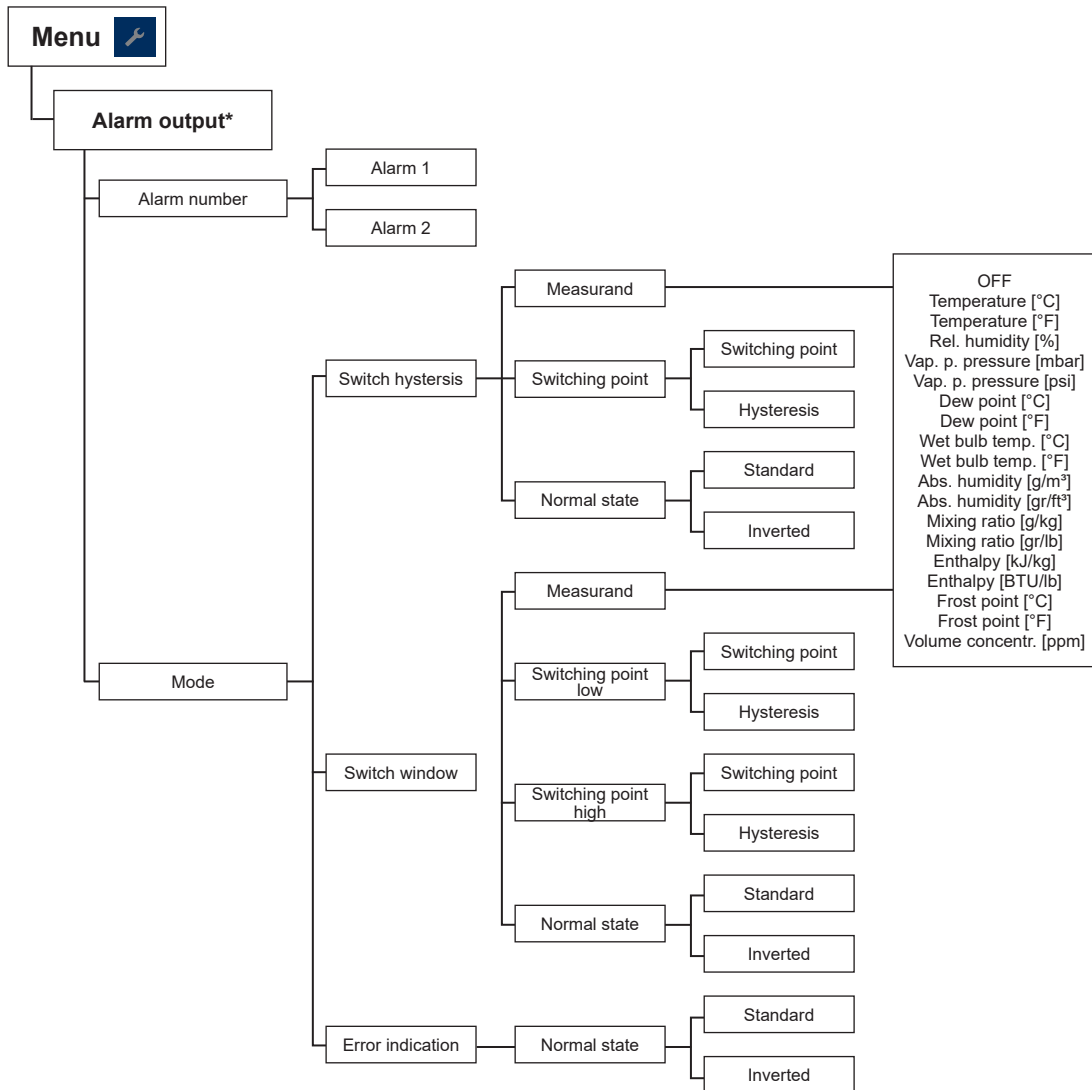

Fig. 51 Status

11.3 Optional Menus

Each of these menus is only available if the according module is plugged in during the start up procedure or if the functionality is ordered by order code, respectively.



* Menu only available with connected alarm module during hydroTRANS H50 start-up

Fig. 52 Alarm output

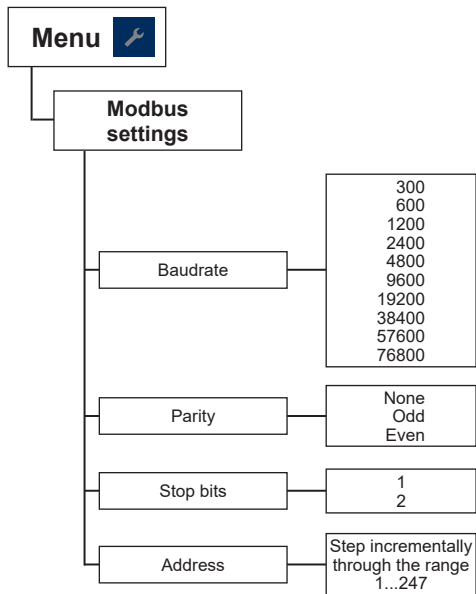

Fig. 53 Modbus settings

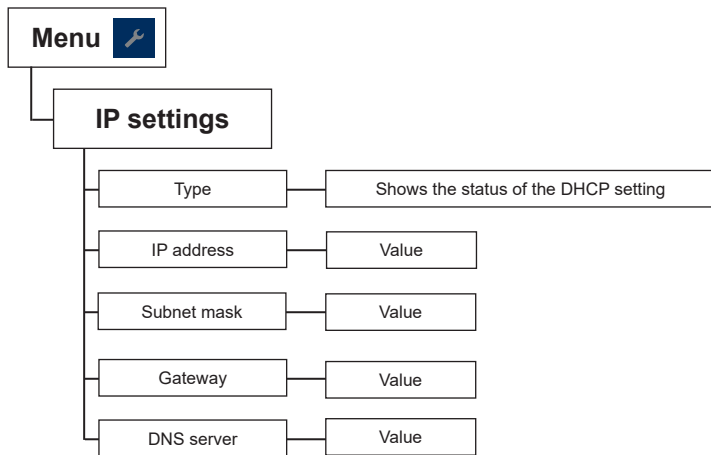

Fig. 54 IP settings



JUMO GmbH & Co. KG

Street address:
Moritz-Juchheim-Straße 1
36039 Fulda, Germany

Delivery address:
Mackenrodtstraße 14
36039 Fulda, Germany

Postal address:
36035 Fulda, Germany

Phone: +49 661 6003-0
Fax: +49 661 6003-607
Email: mail@jumo.net
Internet: www.jumo.net

JUMO UK LTD

JUMO House
Temple Bank, Riverway
Harlow, Essex, CM20 2DY, UK

Phone: +44 1279 63 55 33
Fax: +44 1279 62 50 29
Email: sales@jumo.co.uk
Internet: www.jumo.co.uk

JUMO Process Control, Inc.

6724 Joy Road
East Syracuse, NY 13057, USA

Phone: +1 315 437 5866
Fax: +1 315 437 5860
Email: info.us@jumo.net
Internet: www.jumousa.com

