

JUMO LOGOSCREEN 600

Paperless Recorder with Touchscreen

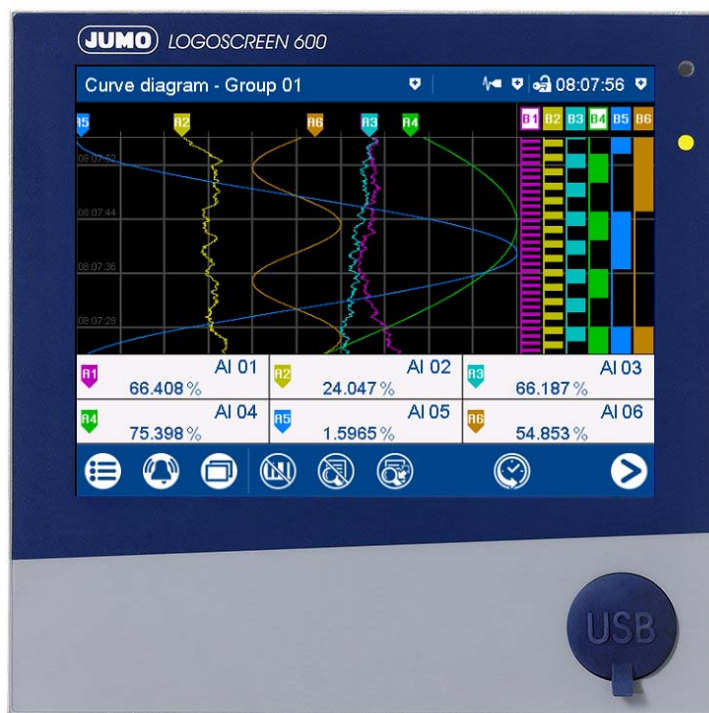

Operating Manual



70652000T90Z001K000

V6.00/EN/00625183

1	Introduction	9
1.1	Safety information	9
1.1.1	Warning symbols	9
1.1.2	Note symbols	9
1.1.3	Intended use	10
1.1.4	Qualification of personnel	10
1.2	Acceptance of goods, storage, and transport	11
1.2.1	Checking the delivery	11
1.2.2	Notes on storage and transport	11
1.2.3	Returning goods	11
1.2.4	Disposal	12
1.3	Identifying the device version	13
1.3.1	Nameplate	13
1.3.2	Order details	14
1.3.3	Scope of delivery	15
1.3.4	Accessories	15
1.4	Content of the technical documentation	16
1.4.1	Device documentation in printed form	16
1.4.2	Device documentation in the form of PDF files	16
1.4.3	Documentation for optional software	16
1.5	Device version	17
1.6	Functions of the device version 02	18
2	Description	19
2.1	Brief description	19
2.2	Block diagram	19
2.3	Display and control elements	20
2.4	Connection elements	20
3	Installation	21
3.1	General information on installation	21
3.2	Dimensions	21
3.3	Panel mounting	22
3.4	Handling the front of the device	23
3.5	Universal carrying case Compact (extra code 970)	23
4	Electrical connection	25
4.1	Installation notes	25
4.2	Galvanic isolation	26
4.3	Connection elements	27
4.4	Connection diagram	28
4.4.1	Analog inputs 1 to 6 (options 1 and 2)	28
4.4.2	Digital inputs 1 to 12 (options 1 and 2)	30

Contents

4.4.3	Analog outputs 1 and 2 (options 1 and 2)	30
4.4.4	Digital inputs/outputs 1 to 12 (option 3)	31
4.4.5	Relay	31
4.4.6	RS232/RS485 interface	32
4.4.7	Voltage supply	32
5	Operation	33
5.1	Operating concept	33
5.1.1	Touchscreen	33
5.1.2	LED displays	35
5.2	Main menu	36
5.2.1	Log-In	36
5.2.2	Configuration	37
5.2.3	Parameterization	37
5.2.4	Device info	37
5.2.5	Audit trail list	37
5.2.6	Service	37
5.2.7	Calibrating the touchscreen	38
5.3	Alarm and event menu	39
5.3.1	Alarm list	40
5.3.2	Event list	41
5.4	Visualization menu (display)	43
5.4.1	Curve diagram	44
5.4.2	Digital diagram	47
5.4.3	Bar graph	48
5.4.4	Text image	49
5.4.5	Report	52
5.4.6	Current batch	54
5.4.7	Completed batch	55
5.4.8	Process screen	57
5.4.9	Counter/Integrator	57
5.4.10	Comment text	58
5.5	Text input dialog	59
5.6	Flash manager	62
5.7	Web server	65
5.8	Electronic signature	67
6	Setup program	73
6.1	Installation	73
6.1.1	Hardware and software requirements	73
6.1.2	Installing and starting the program	73
6.1.3	Logon and rights	74
6.2	User interface	76
6.3	Menu bar functions	79

6.3.1	File	79
6.3.2	Edit	80
6.3.3	Data transfer	81
6.3.4	Extras	82
6.3.5	View	83
6.3.6	Window	83
6.3.7	Info	84
6.4	Setup file	85
6.4.1	Views and functions	85
6.4.2	Create file info	87
6.4.3	Create configuration	88
6.4.4	Transfer setup file	88
7	Configuration	89
7.1	Edit texts during configuration	89
7.2	Selectors	90
7.2.1	Analog selector	90
7.2.2	Digital selector	90
7.3	Basic device (setup only)	93
7.4	Device	94
7.5	Display	97
7.5.1	Start image and watermark (setup only)	97
7.5.2	Screen	98
7.5.3	Colors	99
7.5.4	Generally	100
7.6	Analog inputs	102
7.6.1	Limit value monitoring	108
7.7	Analog outputs	111
7.8	Digital inputs	114
7.8.1	Signal monitoring	114
7.9	Digital inputs/outputs	117
7.9.1	Signal monitoring	118
7.10	Relay	120
7.11	External analog inputs	121
7.11.1	Limit value monitoring	123
7.12	External digital inputs	126
7.12.1	Signal monitoring	127
7.13	External text variables	129
7.14	Limit value monitoring	130
7.14.1	Alarm	131
7.15	Counters/Integrators	134
7.15.1	General settings	134
7.15.2	Specific settings	136
7.16	Flow	144
7.16.1	Limit value monitoring	146

Contents

7.17	Math	149
7.17.1	Limit value monitoring	152
7.18	Logic	155
7.18.1	Signal monitoring	156
7.19	Groups	159
7.19.1	Parameters	159
7.19.2	Analog channels	160
7.19.3	Digital channels	163
7.19.4	Diagram view	163
7.19.5	Standard operation	164
7.19.6	Event operation	167
7.19.7	Time operation	167
7.20	Report	169
7.21	Batch	172
7.21.1	General Information	172
7.21.2	Batch lines	174
7.22	Ethernet	177
7.23	Serial interface	180
7.23.1	Modbus slave	181
7.23.2	Modbus master	182
7.24	Modbus/TCP	184
7.24.1	Modbus slave	184
7.24.2	Modbus master	186
7.25	Time settings	187
7.26	Time server (SNTP)	189
7.27	Undocumented parameters	190
8	Parameterization	191
8.1	Fine adjustment	191
8.2	Counters/Integrators	193
8.3	Limit value monitoring functions	194
8.4	Date and time	195
8.5	Batch	197
8.6	System data	198
9	Configuration – in setup program only	199
9.1	Country settings	199
9.2	User list	202
9.2.1	Default user settings	204
9.2.2	Password rules	204
9.2.3	Character table	205
9.2.4	Public rights	206
9.2.5	Rights (user rights)	207
9.2.6	Overview of rights	208
9.2.7	Behavior after power on	210

9.2.8	Expertise protection	210
9.3	Batch text	211
9.4	Email	212
9.4.1	Email server	213
9.5	Web server	215
9.6	Electronic signature	218
9.7	Modbus frames for reading	220
9.8	Modbus frames for writing	221
9.9	Customer-specific linearization	222
9.9.1	Grid points	224
9.9.2	Formula	225
9.10	Process screens	227
9.10.1	Process screen editor	227
9.10.2	Create process screen	228
9.10.3	Background	229
9.10.4	Object types for process screens (overview)	230
9.10.5	General object features	231
9.10.6	Individual objects	233
9.10.7	Preview screen	244
10	Online parameters	247
10.1	Ethernet	247
10.2	Date and time	248
10.3	Screenshot	249
10.4	Delete recorded data	250
10.5	Reset user list	250
10.6	Additional process values for online data	251
10.7	Enabling of extra codes	252
10.8	Creation of a device certificate	253
10.9	Calibrate / test	254
10.9.1	Hardware/Software	254
10.9.2	Calibration constants	254
10.9.3	Analog inputs	255
10.9.4	Analog outputs	255
10.9.5	Digital inputs	256
10.9.6	Digital inputs/outputs	256
10.9.7	Touch	257
10.9.8	Display and relay	258
10.9.9	Battery	258
11	Annex	259
11.1	Technical data	259
11.1.1	Analog inputs (options 1 and 2)	259
11.1.2	Digital inputs (options 1 and 2)	262
11.1.3	Digital inputs/outputs (option 3)	263

Contents

11.1.4 Analog outputs (options 1 and 2)	263
11.1.5 Relay	263
11.1.6 Interfaces	264
11.1.7 Screen	264
11.1.8 Electrical data	265
11.1.9 Environmental influences	266
11.1.10 Case	266
11.1.11 Approvals / approval marks	266
11.2 Change of the buffer battery	267
11.3 China RoHS	268
11.4 Barcode	269
11.4.1 Batch control	269
11.4.2 Enter event texts and process values	271

1.1 Safety information

1.1.1 Warning symbols



DANGER!

This symbol indicates that **personal injury caused by electrical shock** may occur if the respective precautionary measures are not carried out.



WARNING!

This symbol in connection with the signal word indicates that personal injury may occur if the respective precautionary measures are not carried out.



CAUTION!

This symbol in connection with the signal word indicates that **damage to assets or data loss** will occur if the respective precautionary measures are not taken.



CAUTION!

This symbol indicates that **components could be destroyed** by electrostatic discharge (ESD = Electro Static Discharge) if the respective cautionary measures are not taken. Only use the ESD packages intended for this purpose to return device inserts, assembly groups, or assembly components.



READ DOCUMENTATION!

This symbol – placed on the device – indicates that the associated **device documentation has to be observed**. This is necessary to recognize the kind of the potential hazards as well as the measures to avoid them.

1.1.2 Note symbols



NOTE!

This symbol refers to **important information** about the product, its handling, or additional use.



REFERENCE!

This symbol refers to **further information** in other sections, chapters, or manuals.



FURTHER INFORMATION!

This symbol is used in the tables and refers to **further information** in connection with the table.



DISPOSAL!

This device and the batteries (if installed) must not be disposed in the garbage can after use! Please ensure that they are disposed properly and in an **environmentally friendly manner**.

1 Introduction

1.1.3 Intended use

The device is designed for use as a paperless recorder in an industrial environment as specified in the technical data. Other uses or uses beyond those defined are not viewed as intended uses.

The device has been manufactured in compliance with applicable standards and directives as well as applicable safety regulations. Nevertheless, personal injury or material damage may occur in the event of improper use.

To avoid danger, the device may only be used:

- For the intended use
- When in good order and condition
- When taking into account the technical documentation provided

Risks resulting from the application may arise, e.g. as the result of missing safety provisions or wrong settings, even when the device is used properly and as intended.

1.1.4 Qualification of personnel

This document contains the necessary information for the intended use of the device to which it relates.

It is intended for staff with technical qualifications who have been specially trained and have the appropriate knowledge in the field of automation technology.

The appropriate level of knowledge and the technically fault-free implementation of the safety information and warnings contained in the technical documentation provided are prerequisites for risk-free mounting, installation, and startup as well as for ensuring safety when operating the described modules. Only qualified personnel have the required specialist knowledge to correctly interpret and implement the safety information and warnings contained in this document in specific situations.

1.2 Acceptance of goods, storage, and transport

1.2.1 Checking the delivery

- Ensure that the packaging and contents are not damaged
- Check that the delivery is complete using the delivery papers and the order details
- Inform the supplier immediately if there is any damage
- Store damaged parts until clarification is received from the supplier

1.2.2 Notes on storage and transport

- Store the device in a dry, clean environment. Observe the admissible environmental conditions (see "Technical data")
- Protect the device from shock during transport
- The original packaging provides optimum protection for storage and transport

1.2.3 Returning goods

In the event of repair, return the complete device in clean condition.
Use the original packaging to return goods.

Accompanying letter for repair

Please include the completed accompanying letter for repair when returning goods.
Do not forget to state the following:

- Description of the application and
- Description of the error that has occurred

The accompanying letter for repair can be downloaded online from the manufacturer's homepage (use the search function if necessary).

Protection against electrostatic discharge (ESD)

(ESD = electrostatic discharge)

To prevent damage due to ESD, electronic modules or components must be handled, packaged, and stored in an ESD-protected environment. Measures against electrostatic discharge and electrical fields are described in DIN EN 61340-5-1 and DIN EN 61340-5-2 "Protection of electronic devices from electrostatic phenomena".

When returning electronic modules or components, please note the following:

- Pack sensitive components only in an environment providing protection against ESD. Workspaces such as this divert electrostatic charges to ground in a controlled manner and prevent static charges due to friction.
- Use only packaging intended specifically for ESD-sensitive modules/components. These must consist of conductive plastics.

No liability can be assumed for damage caused by ESD.

1 Introduction



CAUTION!

Electrostatic charges occur in non-ESD-protected environments.
Electrostatic discharges can damage modules or components.
For transport purposes, use only the ESD packaging provided.

1.2.4 Disposal

Disposing of the device



DISPOSAL!

Devices and/or replaced parts should not be placed in the refuse bin at the end of their useful life as they consist of materials that can be recycled by specialist recycling plants.

Dispose of the device and the packaging material in a proper and environmentally friendly manner.

For this purpose, observe the country-specific laws and regulations for waste treatment and disposal.

Disposing of the packaging material

The entire packaging material (cardboard packaging, inserts, plastic film, and plastic bags) is fully recyclable.

1.3 Identifying the device version

1.3.1 Nameplate

The nameplate is affixed to the case.

Contents

The nameplate contains important information. This includes:

Description	Description on the nameplate	Example
Device type	Type	706520/18-100-25/260
Part no.	PN	00XXXXXX
Serial number	F-no.	0070033801215510006
Voltage supply	-	DC 24 V +25/-20 %

Device type (type)

Compare the specifications on the nameplate with the order.

Identify the supplied device version using the order details (order code).

Part no. (PN)

The part no. clearly identifies an article in the catalog. It is important for communication between the customer and the sales department.

Fabrication no. (F-no.)

Among other things, the fabrication number contains the date of production (year/week).

Example: F-no. = 00700338012**1551**0006

The characters in question are in positions 12, 13, 14, and 15 (from the left).

The device was therefore produced in the 51st calendar week of 2015.

1 Introduction

1.3.2 Order details

(1) Basic type	
706520	Paperless recorder with 1x Ethernet, 2x USB (1x host, 1x device), and 1x RS232/485 interface and one relay
(2) Basic type extension	
0	Without software package
1	With software package (setup program incl. USB cable, PC Evaluation Software PCA3000, PCA Communication Software PCC; in conjunction with extra code „888“: additionally with software PC Security Manager PCS and PC Audit-Trail Manager PCAT)
(3) Language	
8	Set per default (German/English)
9	Set according to customer specifications
(4) Option 1 (expansion slot 1)¹	
0	Not used
1	3 analog and 6 digital inputs, 1 analog output
(5) Option 2 (expansion slot 2)^a	
0	Not used
1	3 analog and 6 digital inputs, 1 analog output
(6) Option 3 (expansion slot 3)^a	
0	Not used
1	12 digital inputs/outputs (independently configurable as input or output)
(7) Voltage supply	
23	AC 110 to 240 V +10/-15 %, 48 to 63 Hz
25	AC/DC 20 to 30 V, 48 to 63 Hz
(8) Extra code	
.	Not used
260	Math and logic module (6 channels each)
(9) Extra code	
.	Not used
887	Manipulation detection with digital certificate
888	FDA 21 CFR Part 11 with digital certificate
(10) Extra code case	
.	Not used
970	Universal carrying case Compact ²

¹ Subsequent expansion is only possible in JUMO Central Services.

² This extra code is only available in combination with voltage supply AC 110 to 240 V. The UL approval is not applicable. Use only by technically qualified personnel who are specially trained and have the relevant knowledge in the field of automation technology! Observe the ambient temperature and the protection type (see technical data)!

Order code (1) (2) (3) (4) (5) (6) (7) (8) (9) (10)
 Order example 706520 / 1 8 - 1 0 0 - 23 / 260 , 887 , 970

1.3.3 Scope of delivery

1 paperless recorder in the ordered version
1 brief instructions
4 mounting elements
1 CD with detailed operating manual and supplementary documentation

1.3.4 Accessories

Description	Part no.
Setup program	00645110
USB cable, A-plug to micro-B-plug, 3 m	00616250
PC Evaluation Software PCA3000	00431882
PCA Communication Software PCC	00431879
PC software package consisting of: Setup program, PC Evaluation Software PCA3000, PCA Communication Software PCC, PC Security Manager PCS and PC Audit-Trail Manager PCAT. Please specify all version numbers when placing repeat orders.	00666817
USB memory stick, 2 GB ¹	00505592
Activation for math and logic module (setup program required)	00393217
TP-LINK TL-WR710N (Wi-Fi router)	00658592

¹ The USB memory stick indicated has been tested and is designed for industrial applications. No liability is assumed for other brands.

1 Introduction

1.4 Content of the technical documentation

The documentation for this device is addressed to equipment manufacturers (OEMs) and users with appropriate technical expertise; it consists of the following documents.

1.4.1 Device documentation in printed form

70652000T97...

Brief instructions

A hard copy of the brief instructions is part of the scope of delivery of the device.

The brief instructions describe the installation, the electrical connection and the operation of the device. They also contain the order details and a list of technical data.

The brief instructions are an excerpt from the operating manual.

1.4.2 Device documentation in the form of PDF files

The documents specified below are stored as PDF files on the CD contained in the scope of delivery of the device. They can also be downloaded from the manufacturer's website.

70652000T10...

Data sheet

The data sheet contains general information about the device, the order details, and the technical data. It forms the basis for selecting the device and making a purchasing decision.

70652000T90...

Operating manual

The operating manual contains full details on installation, the electrical connection, operation, parameterization and configuration of the device. In addition, it contains the order details and a list of technical data.

In the case of the present device, the operating manual also describes the use of the setup program (PC program) with which the device can also be configured.

70652000T92...

Interface description (Modbus)

The interface description provides information on communication with other devices or superordinate systems using the Modbus protocol (Modbus RTU, Modbus/TCP).

In the case of the present device, the interface description contains specifications on communication via Ethernet.

70652000T97...

Brief instructions

The brief instructions are also available as a PDF file and have the same scope as the printed document.

1.4.3 Documentation for optional software

The following manuals in the form of PDF files are available for download from the manufacturer's website. They also form part of the scope of delivery of the respective software.

B 709701.0

PC Evaluation Software PCA3000

The operating manual describes the operation and the features of the PC Evaluation Software. The PC Evaluation Software helps to visualize and evaluate the recorded registration data (measurement data, batch data, messages, etc.).

B 709702.0

PCA Communications Software PCC

The operating manual describes the operation and the features of the PCA Communication Software. The PCA Communication Software is responsible for the data transfer from a device or system to a PC or to a network.

B 709703.0

PC Security Manager software PCS

The operating manual describes the operation and the features of the PC Security Manager software. PCS ensures that only authorized persons can gain access to the system components (device, PC software) and sign electronic signatures in electronic documents. The configuration of the Security Manager can only be performed by the system administrator.

PCS is only available for devices with extra code 888.

B 709704.0

PC Audit Trail Manager software PCAT

The operating manual describes the operation and the features of the PC Audit Trail Manager software. PCAT documents actions performed in the PC software components which lead to modifications of files, user lists (rights files), device lists, etc. The different message types are: "Information", "Warnings", and "Errors". Audit trail recordings cannot be modified.

Device audit trail data is not shown in PCAT, only in PCA3000.

PCAT is only available for devices with extra code 888.

1.5 Device version

The device version of the paperless recorder can be determined through the software version (SW version) of the device. The software version is displayed in the "Device info" menu (Main menu > Device info > Versions > Basic device: SW version).

Structure of the software version number (SW version): 323.xx.yy

323 = basic version, xx = device version, yy = current version

In this document, functions which depend on the device version are marked accordingly (e.g. "as of device version 02").

1 Introduction

1.6 Functions of the device version 02

New functions

The following new functions were implemented in device version 02.

- Extra code 887 "Manipulation detection with digital certificate": manipulation detection for the recording data by using a certificate (during saving and transfer)
- Extra code 888 "FDA 21 CFR Part 11 with digital certificate": FDA compliant data recording with special input masks and functions; manipulation detection with digital certificate
- Additional user rights
- User management with PC Security Manager software (PCS) for up to 50 users (only with extra code 888)
- Separate transfer of user table and user groups even for a device without extra code 888
- Electronic signature of the batch report (only with extra code 888)
- Electronic signature for a certain time period (only with extra code 888)
- Electronic signature for user logoff (only with extra code 888)
- Authentication prior to entering the comment text
- Additional objects in process image editor: entering values and text
- Additional barcode functions: control characters for reading event text and process values
- General limit value monitoring functions: limit value and switching differential adjustable in the parameterization as well as through Modbus
- Online visualization configurable as standard version or user version

With extra code 888 the device fully supports the requirements for data recording according to the rules 21 CFR Part 11 of the United States Food and Drug Administration.

The extra code 887 or 888 give the device a TÜV certified function for ensuring data security. A digital device certificate provides proof that the recording data has not been manipulated in the device or during transfer.

Changed functions

The following functions were changed from device version 01:

- Flash manager function "Saving all recording data on USB flash drive (backup)": the user can select a time period from which the recording data is saved. In addition, the current readings of the counters and integrators as well as the statistic (report) – even if they have not yet been completed – can be saved along with the recording data.
- General limit value monitoring functions: increased amount to 24
- Batch texts, comment text: maximum number of characters increased to 160

2.1 Brief description

The JUMO LOGOSCREEN 600 paperless recorder features a resistive touchscreen and an intuitive, icon-based operation and visualization concept that makes it very easy to use.

There are different versions of the JUMO LOGOSCREEN 600 available for process data recording. These range from the device version without measuring input in which up to 24 process values are read (master) or received (slave) from external systems via Modbus, through to a device version with six measuring inputs (universal analog inputs), two analog outputs, 12 digital inputs, and 12 individually switchable digital inputs/outputs. In the version with FDA-compliant data recording all the requirements are met in accordance with 21 CFR Part 11.

The JUMO LOGOSCREEN 600 can display data using the default visualizations, such as curve diagram (vertical or horizontal), bar graph, text image (numerical), or digital diagram. For batch-related processes a special batch recording is available which allows the storage of additional information. In addition, users can create up to six individual process screens with up to 100 objects per process screen to fit their requirements using the setup program.

In addition to the setup program further powerful PC programs are available, e.g. for the evaluation of archived data and for the administration of access control.

2.2 Block diagram

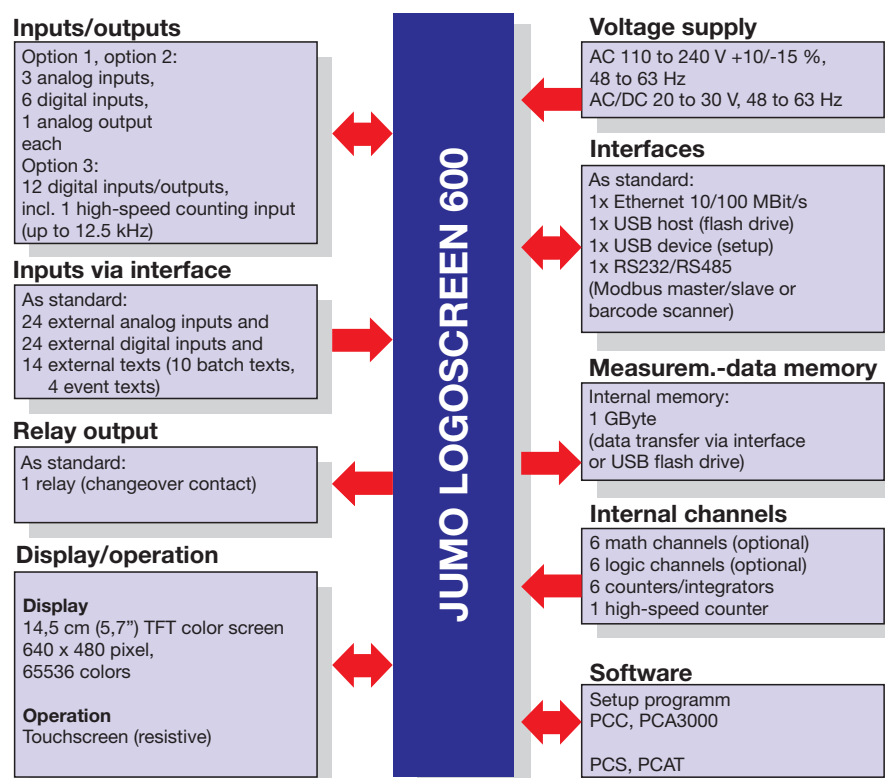

2 Description

2.3 Display and control elements

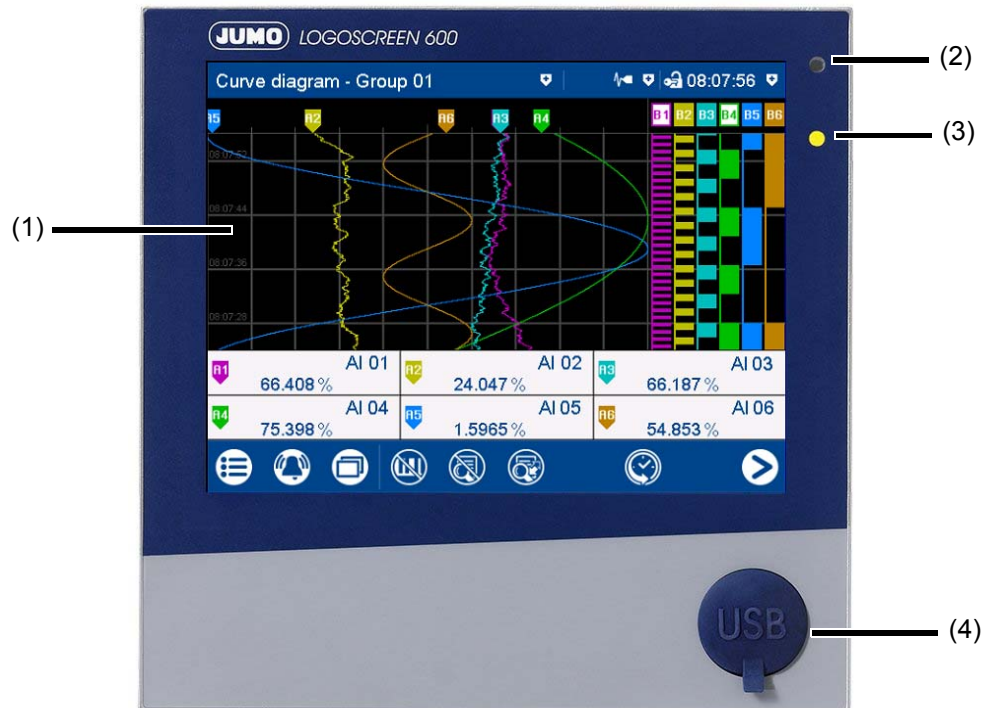

- (1) Touchscreen (TFT color screen)

Technical data:

⇒ Chapter 11.1.7 "Screen", page 264

The screen appearance is described in the "Operation" chapter.

⇒ Chapter 5.1.1 "Touchscreen", page 33

- (2) Alarm LED

The LED is lit while an alarm is pending.

- (3) Power LED

The LED flashes after switching on the device until the startup process is completed. It is then permanently lit.

- (4) USB host interface with cover

To remove the cover, take hold of the lug and pull it out.



CAUTION!

Protection type IP65 (front-side) only with closed USB host interface.

Protection type IP65 is only guaranteed with the available default cover of the USB host interface.

Only remove the cover to use the interface; then remount the cover immediately (the cover must be flush with the front of the device).

2.4 Connection elements

The connecting elements on the rear of the device and the front-side USB host interface are described in the "Electrical connection" chapter.

⇒ Chapter 4.3 "Connection elements", page 27

3.1 General information on installation



WARNING!

The device is not designed for use in potentially explosive areas.
There is the risk of an explosion.
Only deploy the device outside of potentially explosive areas.

Mounting site

The device is designed for installation in a panel cut-out. The front of the device and housing have different protection types (see technical data).

Climatic conditions

The ambient temperature and the relative humidity at the mounting site must correspond to the technical data. Aggressive gases and vapors have a negative effect on the operating life of the device. The mounting site must be free from dust, powder, and other suspended matter.

Installation position

The installation position is not specified, however the screen view angle must be taken into consideration (see technical data).

Technical data

⇒ Chapter 11.1 "Technical data", page 259

3.2 Dimensions

Device

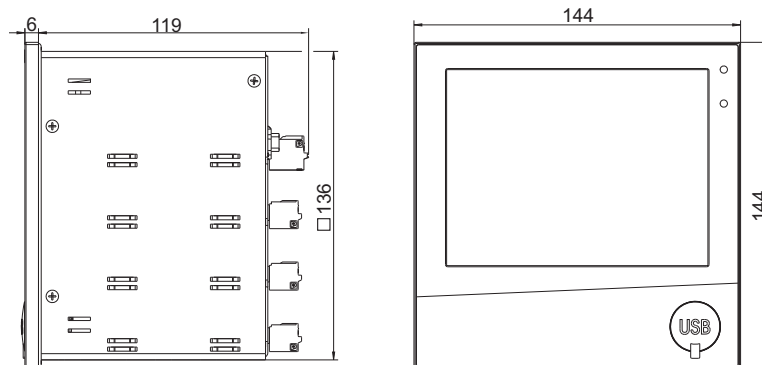

3 Installation

Panel cut-out

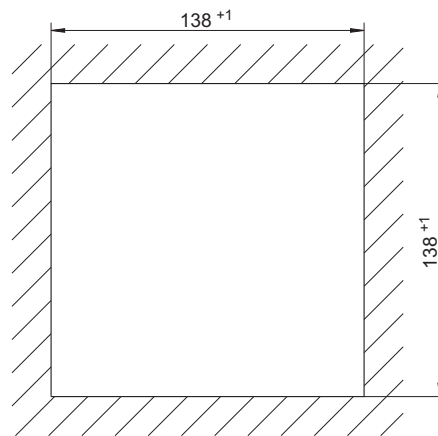

Close mounting

Distance between panel cut-outs	Horizontal	Vertical
Minimum clearance	20 mm	20 mm
Recommended distance (easier installation of fastening elements)	50 mm	50 mm

3.3 Panel mounting

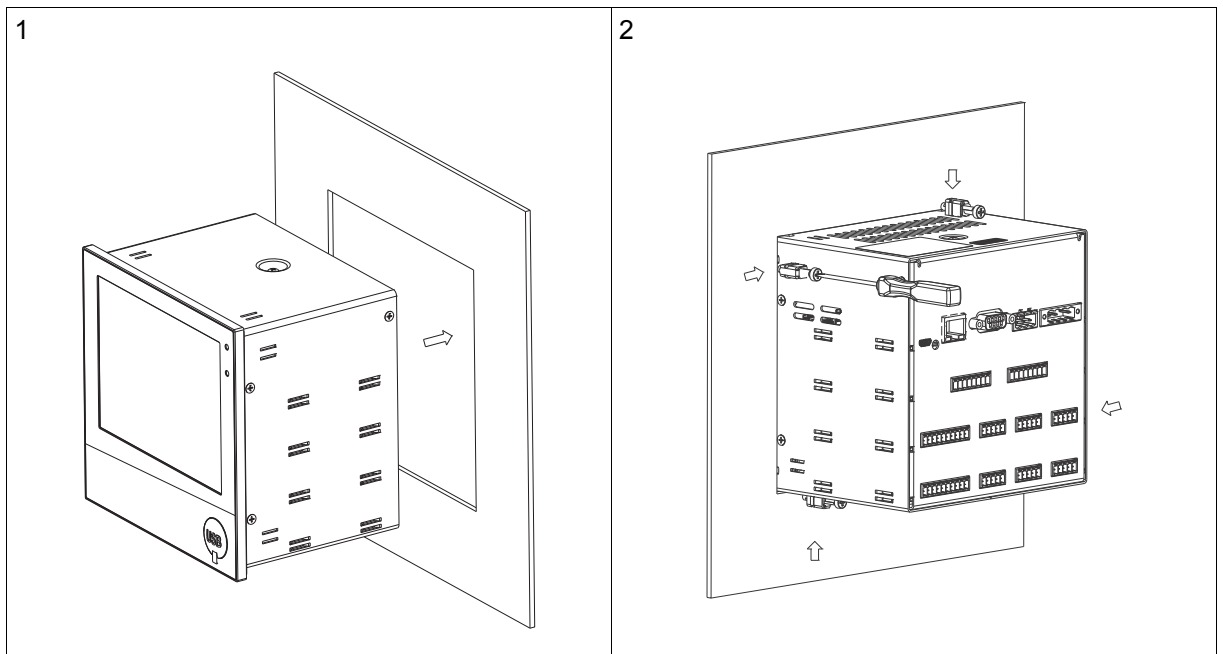

Step	Activity
1	Insert the device into the panel cut-out from the front until the seal is flush with the panel.
2	Insert the fastening elements into the recesses of the housing (one element on each corner, see figure) and use a screwdriver to evenly clamp them against the rear side of the panel with a torque of 1.0 Nm.



CAUTION!

The front of the device and case have different protection types. The protection type IP65 (front-side) is only guaranteed if the seal is flush and even. The four supplied fastening elements must all be used and distributed evenly as shown in the figure.

3.4 Handling the front of the device

Cleaning

The front of the device (front foil) can be cleaned with standard detergents, rinsing and cleaning agents.



CAUTION!

The front of the device is not resistant to aggressive acids and lyes, scouring agents, and cleaning with a pressure cleaner. Use of these media can cause damage. Only clean the front of the device with suitable agents.

Operation

The screen (resistive touchscreen) can be operated by finger pressure or with a commercially available touchscreen stylus.



CAUTION!

Sharp or hard objects are not suitable for operating the screen. They can cause scratches and damage the front foil. Only operate the screen with your finger or with a suitable stylus.

3.5 Universal carrying case Compact (extra code 970)

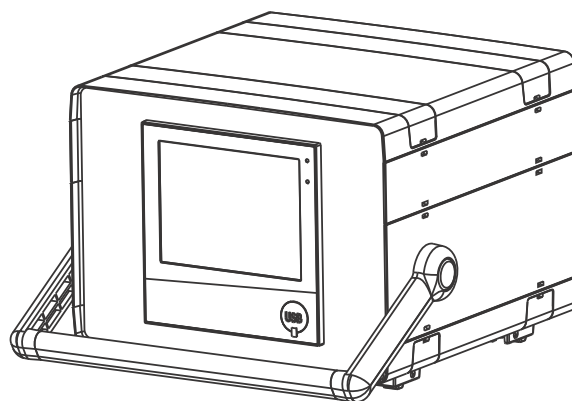

3 Installation

Dimensions

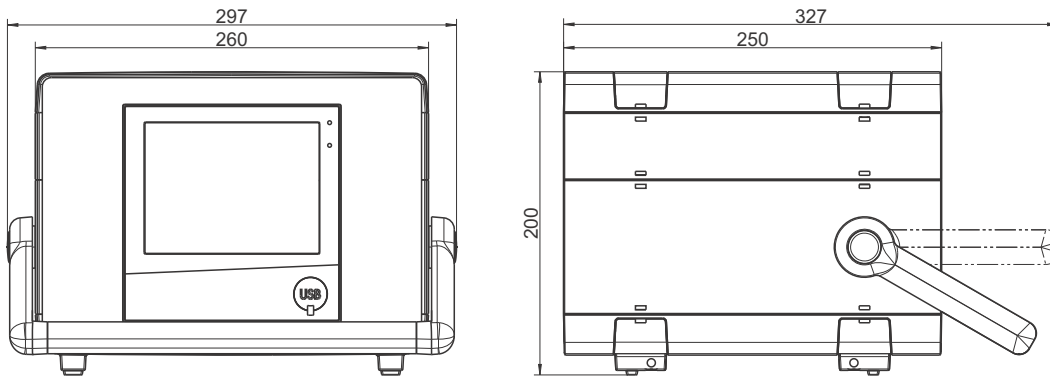

Intended use

The paperless recorder within the carrying case is exclusively intended for use by technically qualified personnel who are specially trained and have the relevant knowledge in the field of automation technology.

Cleaning

For the cleaning of the carrying case, the same instructions apply as for cleaning the front of the device.

⇒ Chapter 3.4 "Handling the front of the device", page 23

Miniature fuse

The carrying case is equipped with a replaceable miniature fuse for device protection (5.0 A / 250 V delayed, acc. to EN 60127-2; part no. 65018001). A defective fuse must be replaced with a fuse of the same type. Beforehand, the carrying case must be disconnected from the mains voltage on all poles (pull the mains plug)!

Power cable

The removeable power cable (H05VV-F 3G1; length 2.5 m; part no. 00052953) must not be replaced with an insufficiently dimensioned cable.

Differing technical data

Observe the information on ambient temperature and protection type of the case!

⇒ Chapter 11.1.9 "Environmental influences", page 266

⇒ Chapter 11.1.10 "Case", page 266

4.1 Installation notes

Requirements for personnel

- Work on the device must only be carried out to the extent described and, like the electrical connection, only by qualified personnel.
- Before plugging and unplugging connecting cables, it must be ensured that the acting person is electrostatically discharged (by touching grounded metallic parts, for example).

Cables, shielding, and grounding

- When selecting the electrical wiring material as well as when installing and connecting the device electrically, comply with the requirements of DIN VDE 0100 "Low-voltage electrical installations" and the applicable country-specific regulations (for example, based on IEC 60364).
- Route input, output, and supply cables separately and not parallel to one another.
- Only use shielded and twisted probe and interface cables. Do not route the lines close to current-carrying components or cables.
- For temperature probes, ground the shielding on one side in the control cabinet.
- Do not perform loophroughs on the grounding cables, but route the cables individually to a shared grounding point in the control cabinet; in doing so, ensure that the cables are as short as possible.
Ensure that the potential equalization is correct.

Electrical safety

- The device is intended to be installed in control cabinets or plants. Ensure that the customer's fuse protection does not exceed 20 A. Disconnect the device from the mains voltage on all poles prior to starting service or repair work.
- The relay's load circuit can be operated with a hazardous electrical voltage (e.g., 230 V). De-energize the load circuit during mounting/dismounting and electrical connection.
- To prevent the relay contacts being destroyed in the case of an external short-circuit in the load circuit, the latter must be fuse-protected as per the maximum admissible relay current (see technical data).
- The device is not suitable for installation in potentially explosive areas.
- In addition to a faulty installation, incorrectly set values on the device can also impair the correct function of the downstream process. Therefore, ensure that safety devices independent of the device, e.g., overpressure valves or temperature limiters/monitors, are available and that it is only possible for qualified personnel to define settings. Please observe the corresponding safety regulations in this context.

References to other information

- Electromagnetic compatibility meets the standards and regulations cited in the technical data (see technical data).
- In general, please observe the specifications regarding galvanic isolation.

Technical data

- ⇒ Chapter 11.1 "Technical data", page 259

4 Electrical connection

4.2 Galvanic isolation

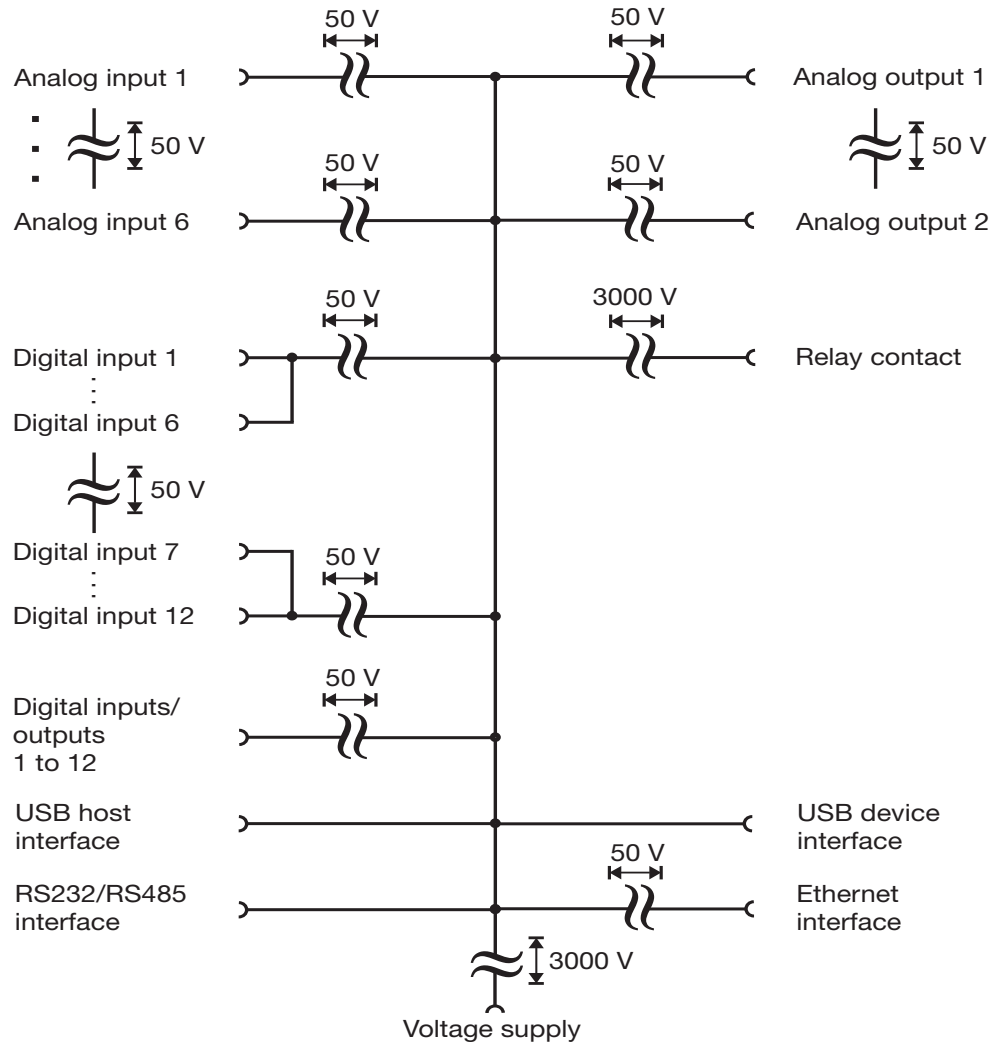

4.3 Connection elements

Front USB host interface (without cover)

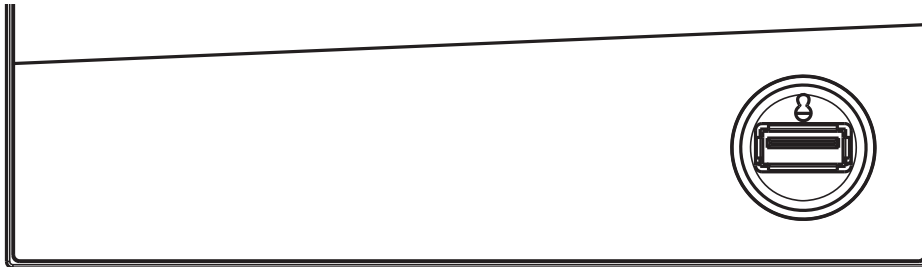

Back connection elements

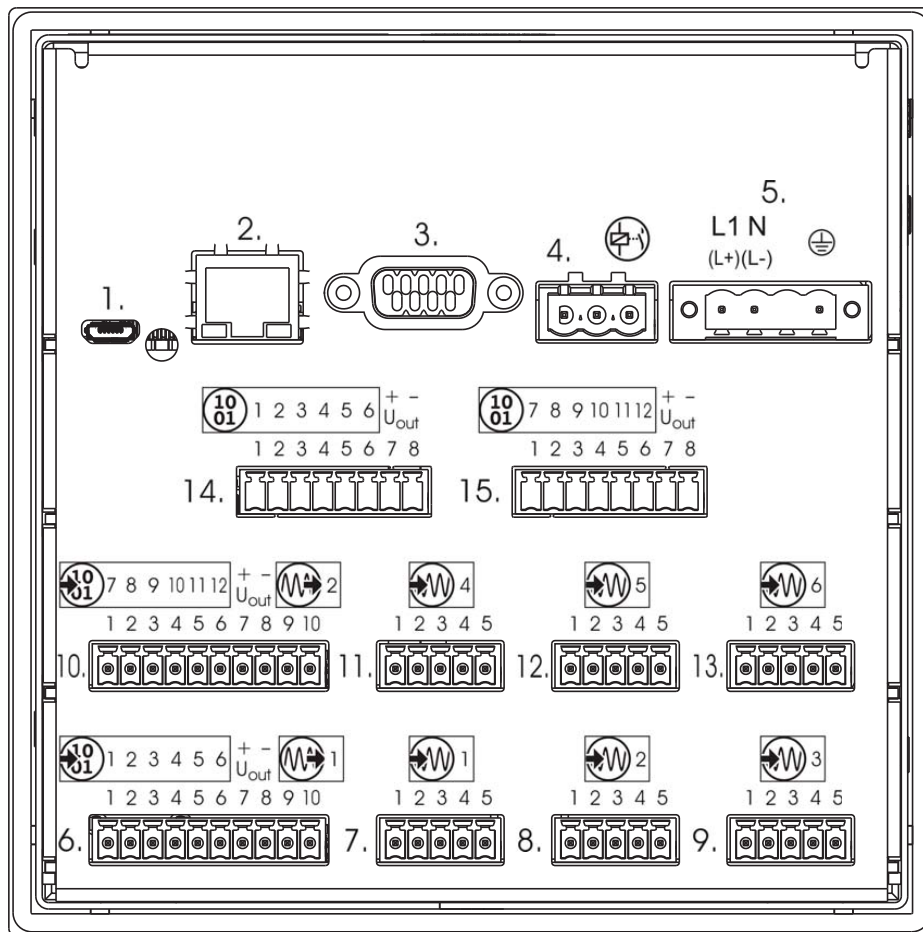

Connection element and assignment

1. USB device interface
3. RS232/RS485 interface
5. Voltage supply
7. Analog input 1
9. Analog input 3
11. Analog input 4
13. Analog input 6
15. Digital inputs/outputs 7 to 12

Connection element and assignment

2. Ethernet interface
4. Relay
6. Digital inputs 1 to 6, analog output 1
8. Analog input 2
10. Digital inputs 7 to 12, analog output 2
12. Analog input 5
14. Digital inputs/outputs 1 to 6

4 Electrical connection



NOTE!

The front-side USB host interface is intended exclusively for connecting a USB flash drive. Any other use is not admissible.



NOTE!

The quality of the USB cable and the USB flash drive has an influence on the correct function of the device. It is recommended to use the components provided by the manufacturer (accessories).



CAUTION!

The device is not suitable for connecting to a PoE (Power over Ethernet) port. There is a risk of damage to the device. Connect the device to an Ethernet port without PoE.

4.4 Connection diagram

4.4.1 Analog inputs 1 to 6 (options 1 and 2)

Measuring probe	Connection element / Assignment	Terminals and connection symbol
Thermocouple	7. / Analog input 1 8. / Analog input 2 9. / Analog input 3	
RTD temperature probe two-wire circuit	11. / Analog input 4 12. / Analog input 5 13. / Analog input 6	
RTD temperature probe three-wire circuit		
RTD temperature probe four-wire circuit		
Resistance transmitter		
Resistance/potentiometer two-wire circuit		

4 Electrical connection

Measuring probe	Connection element / Assignment	Terminals and connection symbol
Resistance/potentiometer three-wire circuit	7. / Analog input 1 8. / Analog input 2 9. / Analog input 3	
Resistance/potentiometer four-wire circuit	11. / Analog input 4 12. / Analog input 5 13. / Analog input 6	
Voltage DC -10(0) to +10 V		
Voltage DC -1(0) to +1 V		
Voltage DC 0 to 70 mV		
Current DC 0(4) to 20 mA		

4 Electrical connection

4.4.2 Digital inputs 1 to 12 (options 1 and 2)

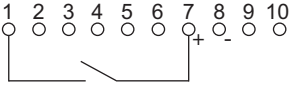
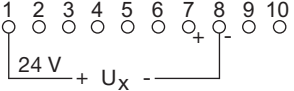
Version	Connection element.Terminal / Assignment	Terminals and connection symbol
Digital input DC 0/24 V, auxiliary voltage (output) DC 24 V (50 mA, per option)	6.1 / Digital input 1 6.2 / Digital input 2 6.3 / Digital input 3 6.4 / Digital input 4 6.5 / Digital input 5 6.6 / Digital input 6 6.7 / +24 V 6.8 / GND 10.1 / Digital input 7 10.2 / Digital input 8 10.3 / Digital input 9 10.4 / Digital input 10 10.5 / Digital input 11 10.6 / Digital input 12 10.7 / +24 V 10.8 / GND	 <p>Example: potential-free contact at input 1 and +24 V (auxiliary voltage)</p>  <p>Example: external voltage at input 1 and GND</p>

4.4.3 Analog outputs 1 and 2 (options 1 and 2)

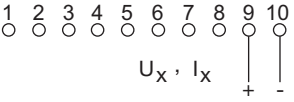
Version	Connection element.Terminal / Assignment	Terminals and connection symbol
Analog output DC 0 to 10 V or DC 0(4) to 20 mA (configurable)	6.9 / Analog output 1 + 6.10 / Analog output 1 - 10.9 / Analog output 2 + 10.10 / Analog output 2 -	

4 Electrical connection

4.4.4 Digital inputs/outputs 1 to 12 (option 3)

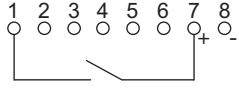
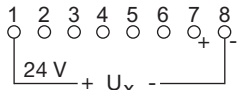
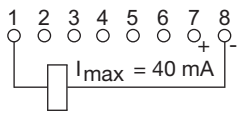
Version	Connection element.Terminal / Assignment	Terminals and connection symbol
Digital input DC 0/24 V or digital output DC 0/24 V (individually switchable), auxiliary voltage (output) DC 24 V (100 mA, sum of the currents at the terminals 14.7 and 15.7)	14.1 / Digital input/output 1 14.2 / Digital input/output 2 14.3 / Digital input/output 3 14.4 / Digital input/output 4 14.5 / Digital input/output 5 14.6 / Digital input/output 6 14.7 / +24 V 14.8 / GND 15.1 / Digital input/output 7 15.2 / Digital input/output 8 15.3 / Digital input/output 9 15.4 / Digital input/output 10 15.5 / Digital input/output 11 15.6 / Digital input/output 12 15.7 / +24 V 15.8 / GND	 <p>Example: potential-free contact at input 1 and +24 V (auxiliary voltage)</p>  <p>Example: external voltage at input 1 and GND</p>  <p>Example: external relay at output 1 and GND (max. 40 mA per output, max. 100 mA on the whole)</p>
Note: Auxiliary voltage supply and digital outputs deliver together max. 100 mA at 24 V.		

4.4.5 Relay

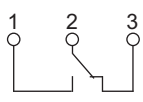
Version	Connection element.Terminal / Assignment	Terminals and connection symbol
Relay (changeover contact) (max. 3 A at AC 230 V, resistive load)	4.1 / Normally open contact (NO) 4.2 / Joint contact (C) 4.3 / Normally closed contact (NC)	

4 Electrical connection

4.4.6 RS232/RS485 interface

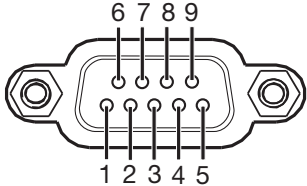
Version	Connection element.Pin / Assignment	Connection element
RS232 9-pin SUB-D socket (switchable to RS485)	3.2 / RxD (received data) 3.3 / TxD (transmission data) 3.5 / GND (ground)	
RS485 9-pin SUB-D-socket (switchable to RS232)	3.3 / TxD+/RxD+ (transmission/ received data +) 3.5 / GND (ground) 3.8 / TxD-/RxD- (transmission/ received data -)	

4.4.7 Voltage supply

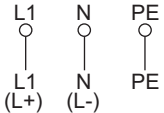
Version	Connection element.Terminal / Assignment	Terminals and connection symbol
AC 110 to 240 V +10/-15 %, 48 to 63 Hz or AC/DC 20 to 30 V, 48 to 63 Hz Observe order details!	5.L1 / Line conductor (for DC: positive terminal L+) 5.N / Neutral conductor (for DC: negative terminal L-) 5.PE / Protection conductor	

5.1 Operating concept

The device is equipped with a resistive touchscreen; the operation is menu-driven. User management protects the device against unauthorized access. The different users can be assigned different privileges so that they can only access specific functions.

In addition to the visualizations available per default, the setup program can be used to create individual process screens for presenting process data.

Thanks to the integrated web server, certain visualizations can also be rendered in a web browser.

5.1.1 Touchscreen

The visualization screen shown after switching on the device depends on the configuration (Device: Main menu > Configuration > Display > Generally > Image after reset; see also operating manual, "Configuration" chapter).

⇒ Chapter 7.5.4 "Generally", page 100"

The example shown here is the curve diagram (vertical, with digital traces).

View

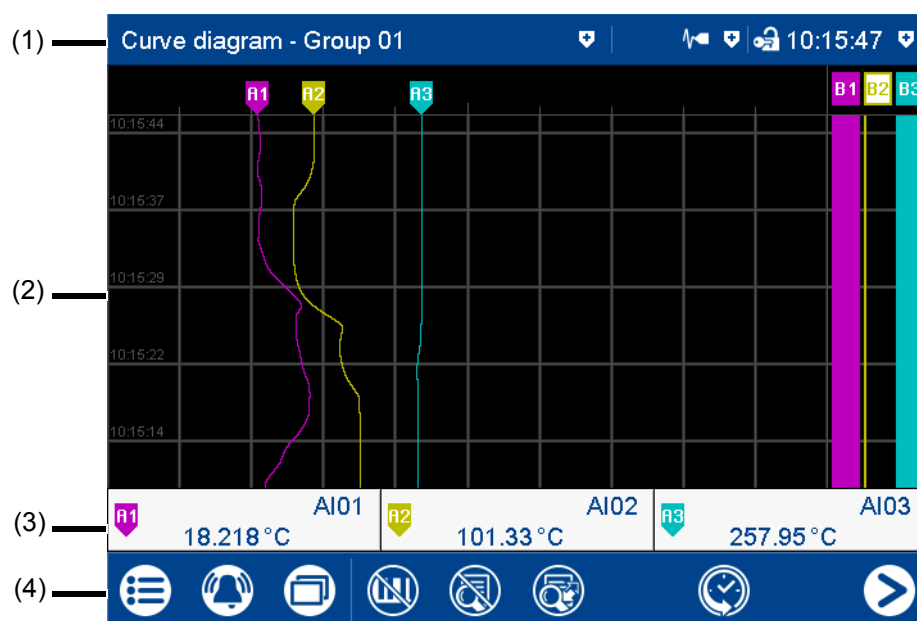

- | | |
|--|--|
| (1) Status bar | (2) Screen (here: curve diagram with digital traces) |
| (3) Channel information (display depends on the configuration) | (4) Navigation bar |

Status bar







The status bar consists of three areas which are delimited by vertical lines. Each area is an active button which can be used to display (⊕) and hide additional information again (⊖).

The **area on the left** shows you the diagram type and group number. Tapping the button displays the alarm list.

5 Operation



The **area in the center** is used to display the status, logging operation, and communication types based on icons. The button displays details of the group operating mode (depending on the screen), the batch logging status, and the status of data transmission via the PCC software as a text display.

Icons used:

Position	Meaning	Icon
Left	Data transmission via PCC software	
	- Transmission active	
	- Transmission not active	No icon
Center	Batch recording	
	- Recording active	
	- Recording not active (or batch not configured)	No icon
Right	Operating mode	
	- Standard operation	
	- Event operation	
	- Time operation	

The **area on the right** shows the logon status as an icon and the time. The button additionally shows the weekday, date, user name, and memory usage.

Icons used:

Position	Meaning	Symbol
Left	Logon status	
	- User not logged in	
	- User logged in	

The status bar is also used as an **alarm display**. In the event of an alarm, the alarm text (red background) and the normal text (blue background) are alternately displayed.

Image

The image area displays the current visualization, menu (e.g., Main menu) with its menu items, or a list (e.g., event list).

Channel information

 R1	AI01	18.218 °C	 R2	AI02	101.33 °C	 R3	AI03	257.95 °C
--	------	-----------	--	------	-----------	--	------	-----------

The channel information display in the curve diagram can be switched on and off (configuration). The description (pointer) of the analog signal (e.g., A1) is displayed along with the abbreviation of the analog or digital signal (e.g., AI01 for analog input 1) and the analog value.

Navigation bar



The navigation bar consists of three areas which are delimited by vertical lines.

The **area on the left** contains the buttons (icons) for calling up

- the main menu (left),
- the alarm and event menu (center), and
- the visualization menu (right).

The **area in the center** contains buttons (icons) whose function depends on the screen currently being displayed.

The **area on the right** contains buttons (icons) for screen navigation:

The "Home" button takes the user directly to a specific screen (configurable).

Pressing the "Next" button (right arrow) selects the next screen on a specific level (e.g., toggle to the next active group).

5.1.2 LED displays

The device is equipped with two LEDs on its front side that display the device status.

Green LED

The green LED (power LED) flashes after switching on the device until the startup process is completed. It is then permanently lit.

Red LED

The red LED (alarm LED) is permanently lit while an alarm is pending.

Acknowledging the collective alarm in the alarm list does not reset the alarm display.

5 Operation

5.2 Main menu



The main menu contains functions for configuring, parameterizing, and operating the device.

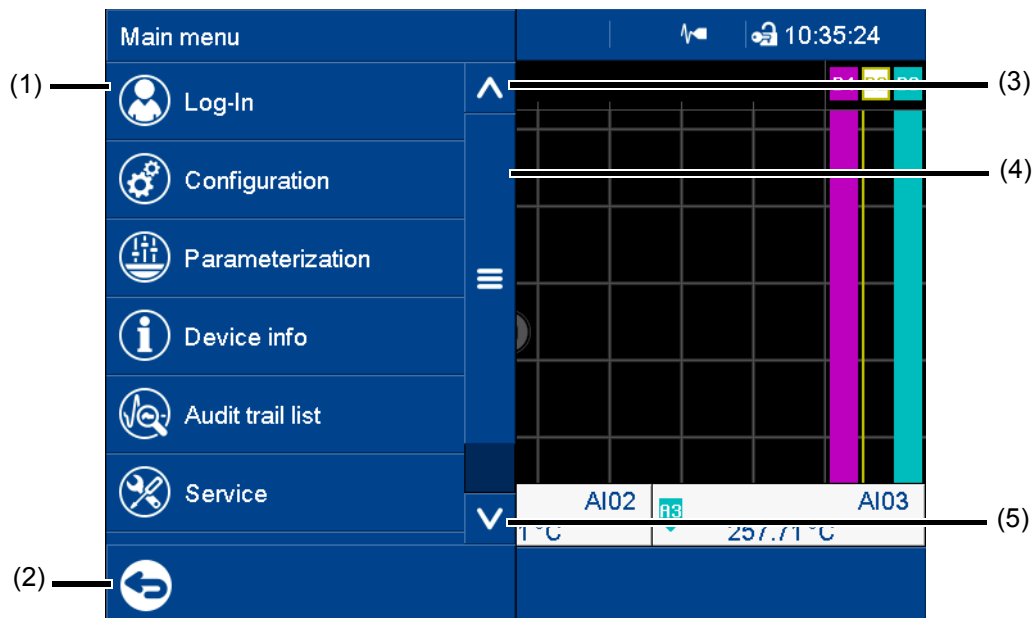

- (1) Menu items
- (2) Quit main menu
- (3) Scroll up
- (4) Scroll box (current position within the menu); movable
- (5) Scroll down

5.2.1 Log-In



This is the menu in which users log on and off, and change their passwords. The following IDs, names, and passwords are set by default:

Users	ID	Name	Password
User 1	Master	System Master	9200
User 2	User 1	Data Management	1
User 3	User 2	Data Management	2
User 4	User 3	Data Management	3
User 5	Service	Service	9200

For further information: see operating manual, chapter "Configuration - only in setup program" > "User list" > "Default user settings").

⇒ Chapter 9.2.1 "Default user settings", page 204

Logoff with signature

With extra code 888 (FDA, as of device version 02) and with the corresponding configuration in the PCS software, an electronic signature is required when logging off. The signature applies to the entire time period for which the user is logged on.

Configuration of the electronic signature: see operating manual, "Configuration – in setup program only" chapter > "Electronic signature".

⇒ Chapter 9.6 "Electronic signature", page 218

Example of an electronic signature:

⇒ Chapter 5.8 "Electronic signature", page 67

5.2.2 Configuration



This menu contains functions for configuring the device. The functions are available both on the device and in the setup program (see the "Configuration" chapter in the operating manual).

⇒ Chapter 7 "Configuration", page 89

In addition to this, there are functions that can only be configured with the setup program (see the operating manual, chapter "Configuration - in setup program only" and "Online parameters").

⇒ Chapter 9 "Configuration – in setup program only", page 199

⇒ Chapter 10 "Online parameters", page 247

5.2.3 Parameterization



This menu contains the functions for parameterizing the device (see the "Parameterization" chapter in the operating manual).

⇒ Chapter 8 "Parameterization", page 191

5.2.4 Device info



This menu contains information about the device (name, versions), the current process values (inputs, outputs, internal functions), and Ethernet interface.

The device version is indicated through the "Version" parameter in the submenu "Versions" > "Basic device":

Standard = device in standard version

21 CFR Part 11 = device in FDA compliant version (as of device version 02)

With extra code 887 (digital certificate) or 888 (FDA) information about the digital certificate is also displayed in this menu.

5.2.5 Audit trail list



This menu lists the audit trail messages generated by the device.

All user intervention with the device is automatically recorded and stored in the audit trail list of the device. The audit trail list is managed independently of the event list.

The audit trail list is designed as a ring buffer which can contain a maximum of 150 entries. When the list is full, each new entry causes the oldest entry to be deleted from the list.

5.2.6 Service



This menu contains various service functions.

5 Operation

Default configuration

You can store the current device configuration with this function.

Similarly, a previously stored configuration can be loaded as the current configuration.

5.2.7 Calibrating the touchscreen



This menu enables you to calibrate the touchscreen (position calibration). To do so, you need to tap the center of the crosshairs shown in the corners of the screen one after another.

5.3 Alarm and event menu



The alarm and event menu enables you to call up the alarm list and event list.

View

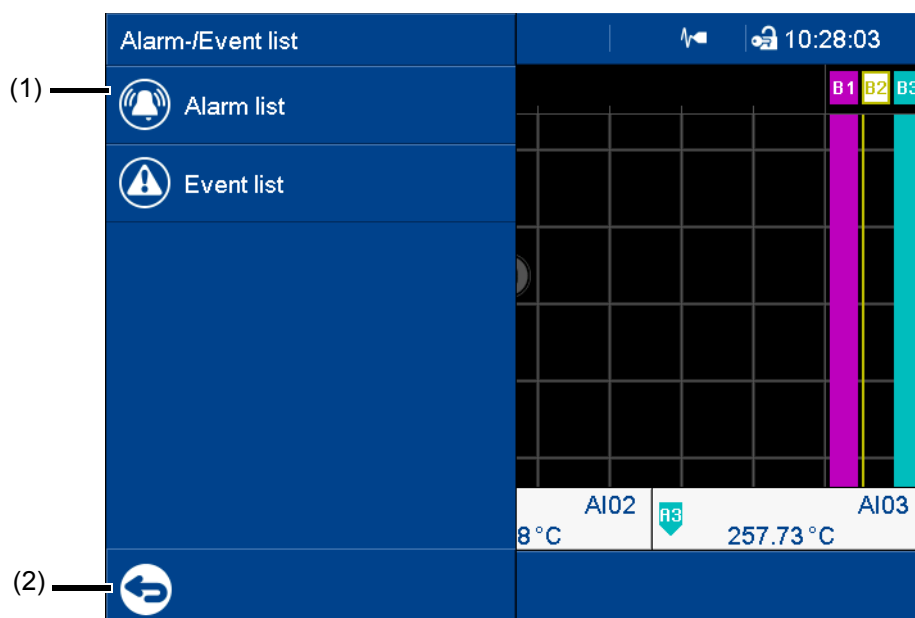

- (1) Menu items
- (2) Quit the alarm and event menu

5 Operation

5.3.1 Alarm list



The alarm list shows all pending alarms in their order of occurrence. If an alarm is no longer pending, its entry is automatically removed from the alarm list. The alarm list is rebuilt after power on.

Each alarm represents an event. For this reason, the time at which an alarm occurs and disappears again is recorded in the event list.

A pending alarm is additionally shown by the red LED in the status bar.

View

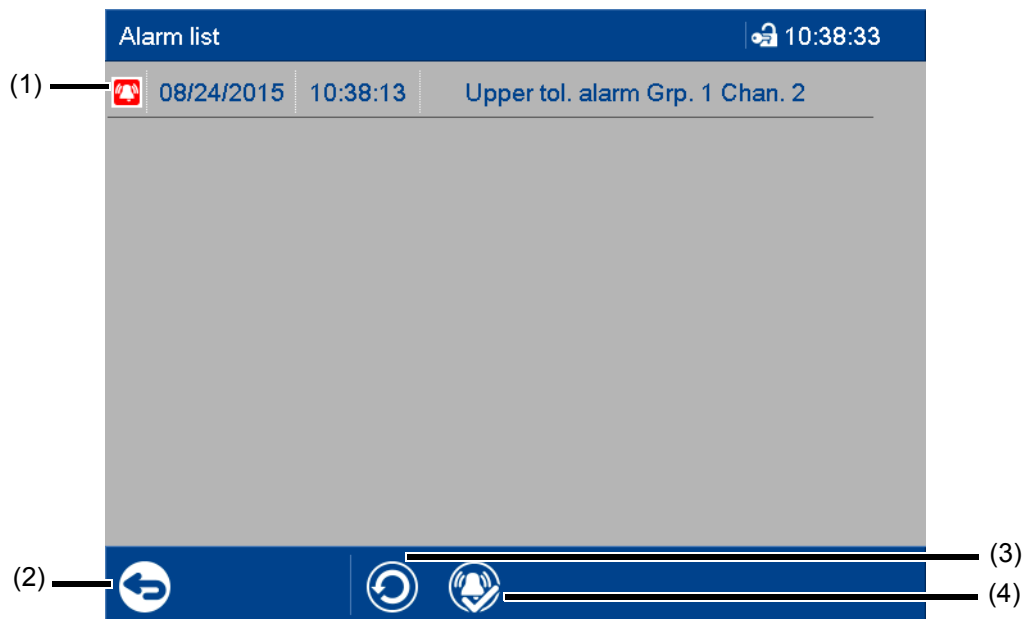

(1) Alarm (time and alarm text)

(3) Update alarm list

(2) Quit alarm list

(4) Acknowledge collective alarm

Collective alarm

The following collective signals are created and are available in the digital selector:

- Collective alarm
This signal is active while an alarm is pending (the alarm list is not empty).
- Collective alarm acknowledged
This signal is activated when an alarm occurs; it remains active until acknowledged even if the alarm disappears in the meantime.

5.3.2 Event list



The event list contains event entries in chronological order. A maximum of 150 entries are stored and displayed. When new entries are added, the oldest entries are deleted. The event list is kept after power off.

As with process data, events are transferred to the PC Evaluation Software PCA3000 for evaluation.

Events include:

- System messages (e.g., power on, configuration change, time sync)
- Device alarms (malfunctions; e.g., battery discharged, data loss, input not calibrated)
- Configured alarms
- Configured events
- Counter messages (counter status and counter reset)
- Batch messages (start and end of batch recording)
- General messages (e.g., comments, error messages from the interfaces, USB flash drive plugged in/removed, collective alarm acknowledged)

View

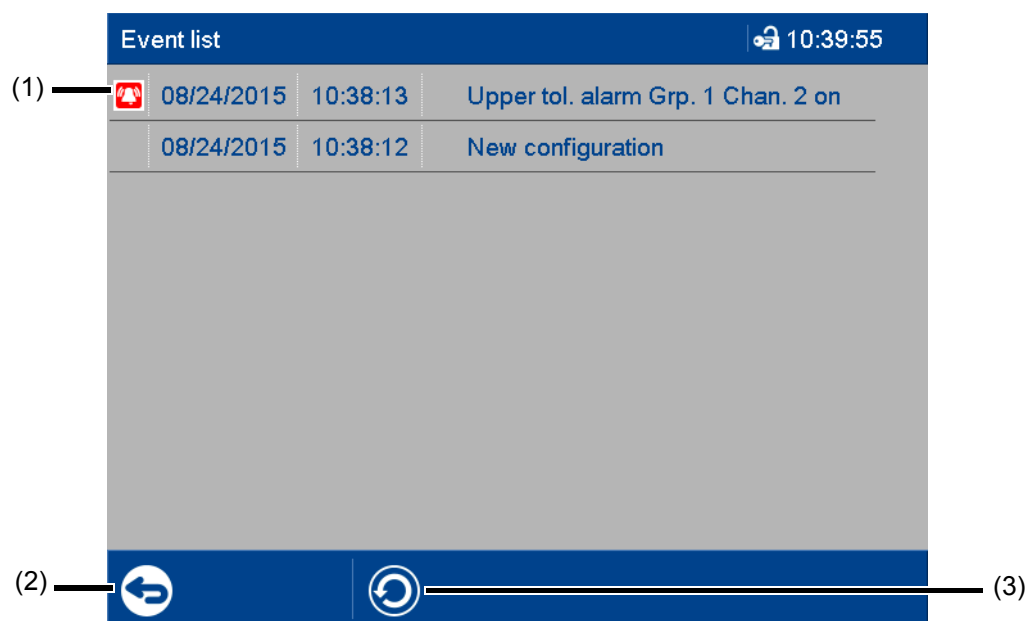

(1) Event (here: alarm) with time and event text (configurable)

(3) Update event list

(2) Quit event list

5 Operation

Event list in memory display

If the alarm and event menu is called up from the memory display (history) (or from the curve presentation of a completed batch), the event list is opened directly. An additional button is available here which lets you mark the time of a specific event in the memory display with the cursor position.

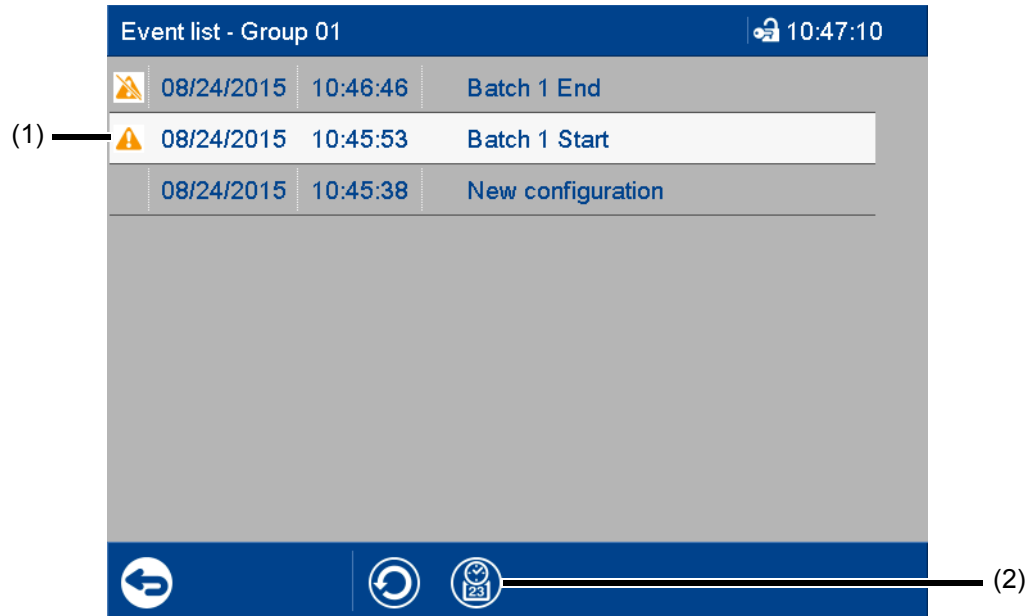

(1) Selected event
The event is selected by tapping.

(2) Show memory display
In the memory display, the cursor is moved to the position (time) at which the event occurred.
If the respective point in time is no longer in the memory display, the cursor is moved to the start of the memory display (oldest point in time).

5.4 Visualization menu (display)



In the visualization menu, the view type and group that should be currently displayed on the device are selected. Up to 6 analog channels and 6 digital channels of a group can be shown on one screen.

View

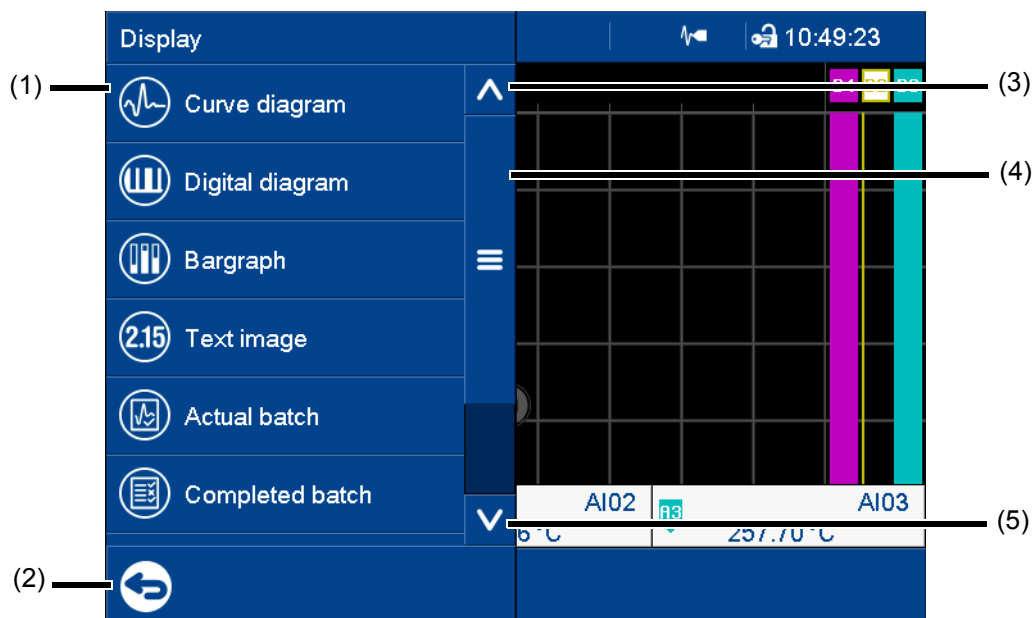

- | | |
|-----------------------------|--|
| (1) Menu items | (3) Scroll up |
| (2) Quit visualization menu | (4) Scroll box (current position within the menu); movable |
| | (5) Scroll down |

5 Operation

5.4.1 Curve diagram



In the curve diagram, the analog and digital signals configured for the relevant group are displayed as analog curves or digital traces. Digital traces and channel information can be hidden in the group configuration.

The diagram type (horizontal, vertical) is selected individually for each group in the configuration. The following view shows the vertical diagram. Accordingly, the description also applies to the horizontal diagram (see the example later on).

Group view

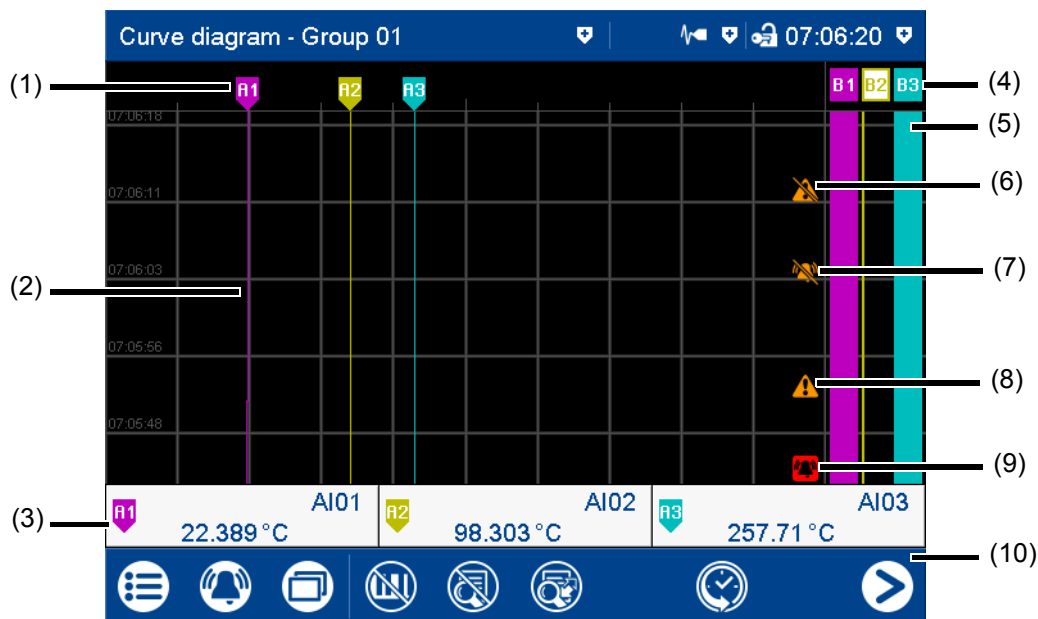

- | | |
|---|--|
| (1) Description (point) of the analog curve | (4) Description (point) of the digital trace |
| (2) Analog curve (color change with alarm) | (5) Digital trace |
| (3) Channel information: description (pointer), short signal description (configurable), and current value of analog signal (color change with alarm) | (6) Event off |
| | (7) Alarm off |
| | (8) Event on |
| | (9) Alarm on |
| | (10) Navigation bar |

Navigation bar



- | | |
|-----------------------------------|--------------------------------------|
| (1) Hide/show digital traces | (4) Call up memory display (history) |
| (2) Hide/show channel information | (5) Go to next active group |
| (3) Hide/show analog values | |

Memory display (history)

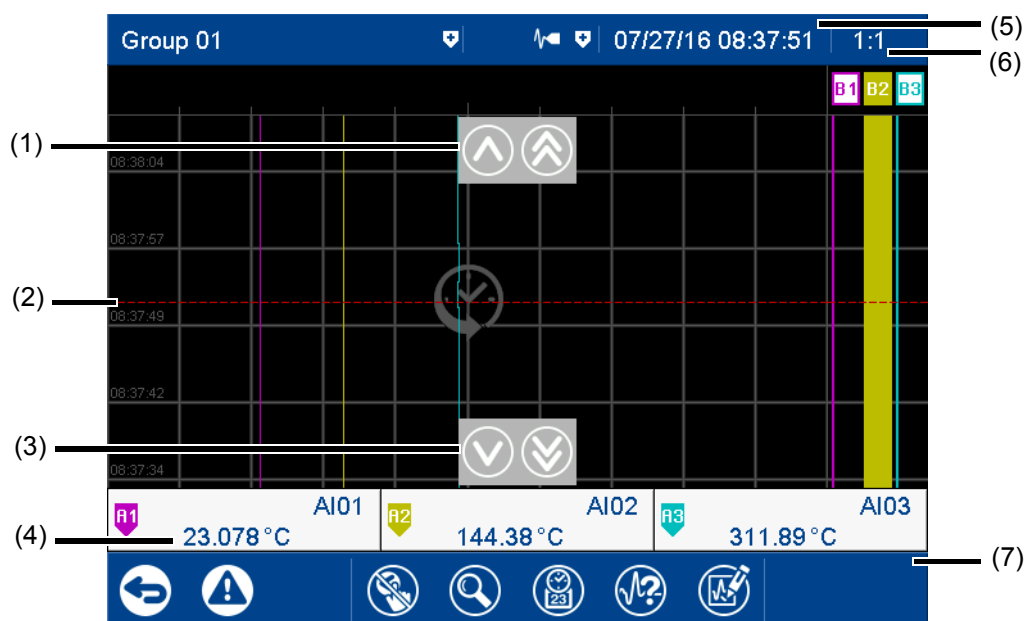

- | | |
|---|---|
| (1) Move time for memory values forward (later memory values) | (5) Time of memory values (cursor position) |
| (2) Cursor (time of numeric memory values) | (6) Zoom factor |
| (3) Move time for memory values back (earlier memory values) | (7) Navigation bar |
| (4) Analog value at selected time | |

Navigation bar

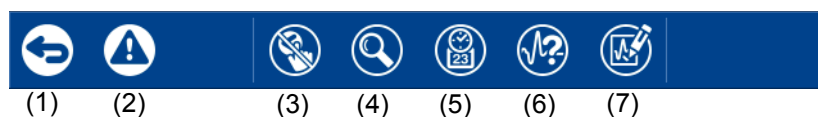

- | | |
|---------------------------|--|
| (1) Quit history | (4) Change zoom factor |
| (2) Access event list | (5) Find memory values (enter time) |
| (3) Hide/show cursor keys | (6) Curve selection (activate/deactivate view) |
| | (7) Rendering electronic signature or display information about rendered signature |

Electronic signature

With extra code 888 (FDA) and with the corresponding configuration in the PCS software a certain time period can be provided with an electronic signature. The signature applies to the time period that is displayed in the diagram at the time of the signature. The displayed area may have to be expanded prior to signing. During signing, the time period can only be reduced; an increase is then no longer possible.

Any user who has the respective authorization can sign this signature ("Confirm batches, electronic signature" right). This can be another user than the one who is currently signed in.

Configuration of the electronic signature: see operating manual, "Configuration – in the setup program only" chapter > "Electronic signature".

5 Operation

⇒ Chapter 9.6 "Electronic signature", page 218

Example of an electronic signature:

⇒ Chapter 5.8 "Electronic signature", page 67

Horizontal diagram

In the horizontal diagram, the analog curves and digital traces run from right to left. The channel information is shown on the right edge of the screen; the icons for event and alarm at the top edge of the screen.

Digital traces and channel information can be hidden in the group configuration, as in the vertical view.

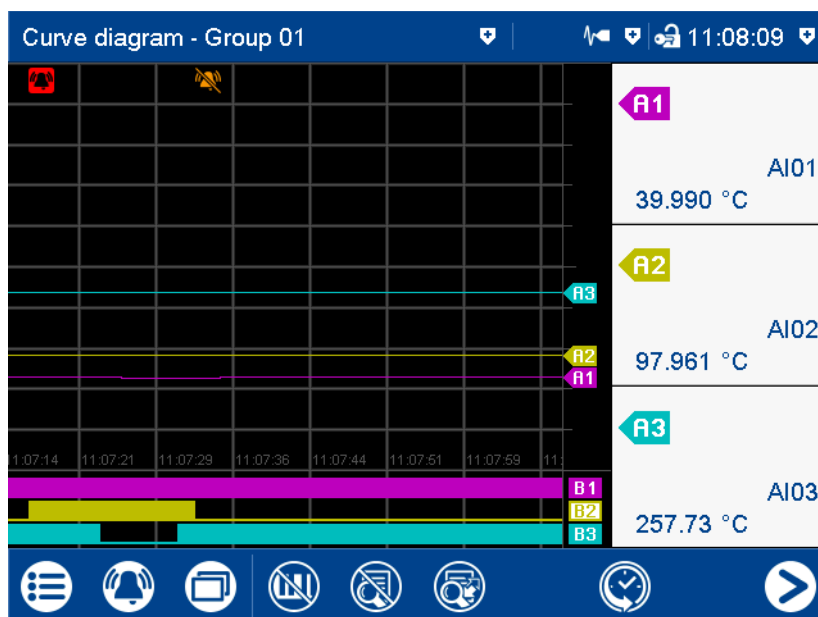

5.4.2 Digital diagram



In the digital diagram, the digital signals configured for the relevant group are displayed as digital traces.

The diagram type (horizontal, vertical) is selected individually for each group in the configuration. The following view shows the vertical diagram. Accordingly, the description also applies to the horizontal diagram.

Group view

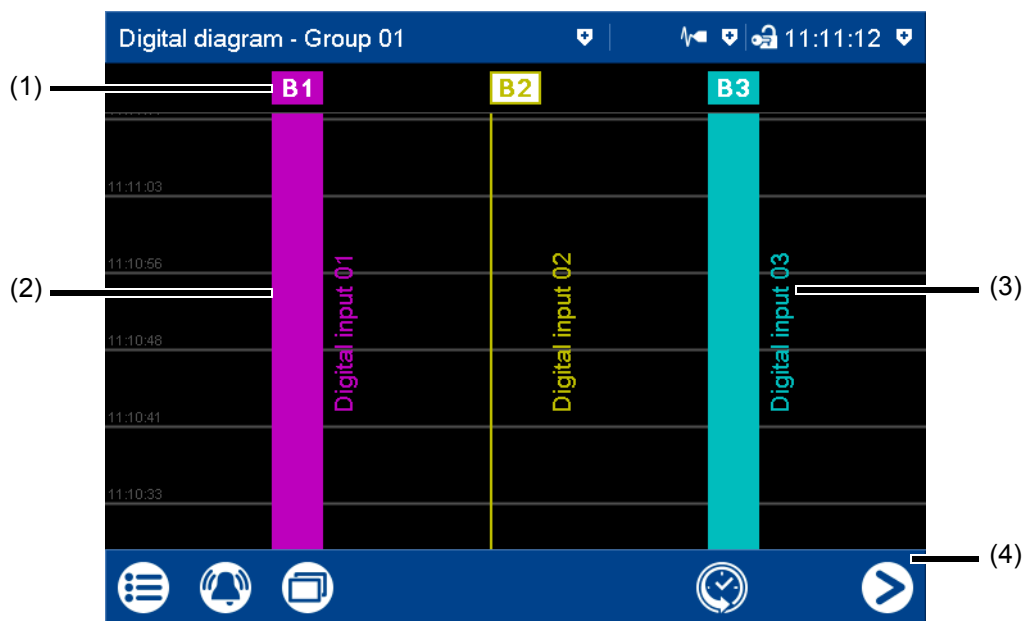

- | | |
|---|---|
| (1) Description (point) of the digital trace
Displays the logical state:
Colored button = HIGH (B1, B3)
Colored frame = LOW (B2) | (3) Digital signal description (configurable) |
| (2) Digital trace | (4) Navigation bar |

Navigation bar



- | | |
|--------------------------------------|-----------------------------|
| (1) Call up memory display (history) | (2) Go to next active group |
|--------------------------------------|-----------------------------|

Memory display

See memory display in the curve diagram.

⇒ Chapter 5.4.1 "Curve diagram", page 44

5 Operation

5.4.3 Bar graph



In the bar graph view, the analog signals configured for the relevant group are shown as bar graphs, and the digital signals – depending on their logical state – as colored areas or frames. The diagram type selected for the group (horizontal, vertical) is irrelevant for the bar graph view. The view is always as a column diagram (vertical) and not as a bar diagram (horizontal).

Group view

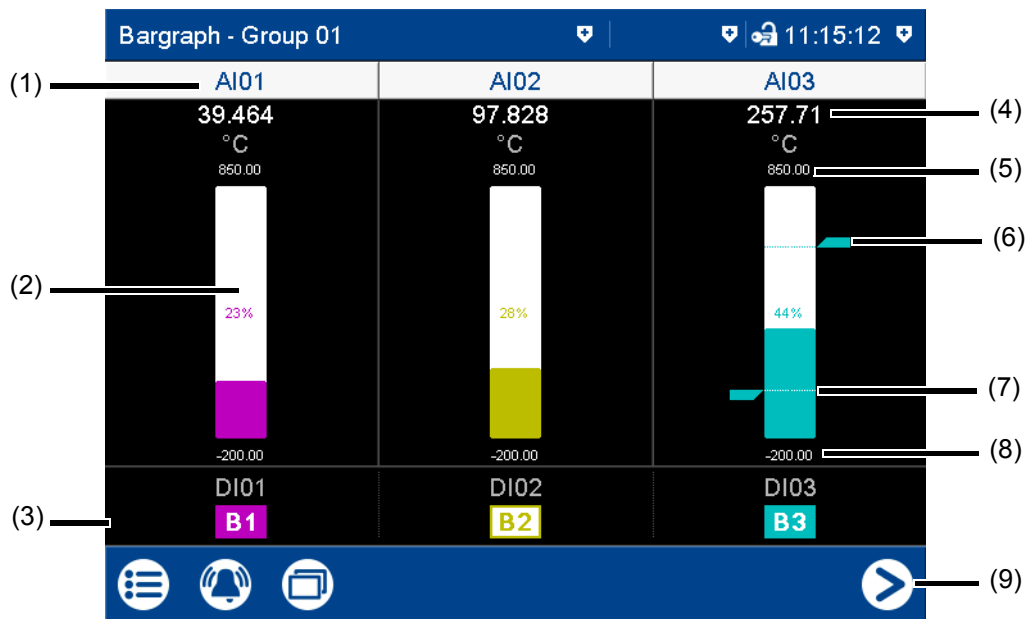

- | | |
|--|--|
| (1) Short analog signal description (configurable)
Call up individual view of analog signal (numerical view and bar graph); see text image - individual view. | (4) Current analog value (color change with alarm) |
| (2) Bar diagram of the analog signal (color change with alarm) | (5) End value of scaling (display range, configurable) |
| (3) Digital signal with short signal description (configurable) and designation (pointer)
Displays the logical state:
Colored button = HIGH (B1, B3)
Colored frame = LOW (B2) | (6) Limit value for max. alarm (configurable) |
| | (7) Limit value for min. alarm (configurable) |
| | (8) Start value of scaling (display range, configurable) |
| | (9) Go to next active group |

5.4.4 Text image



The text image shows the current values for the analog signals configured for the relevant group as numbers. The digital signals – depending on their logical state – are shown as colored areas or frames.

Group view

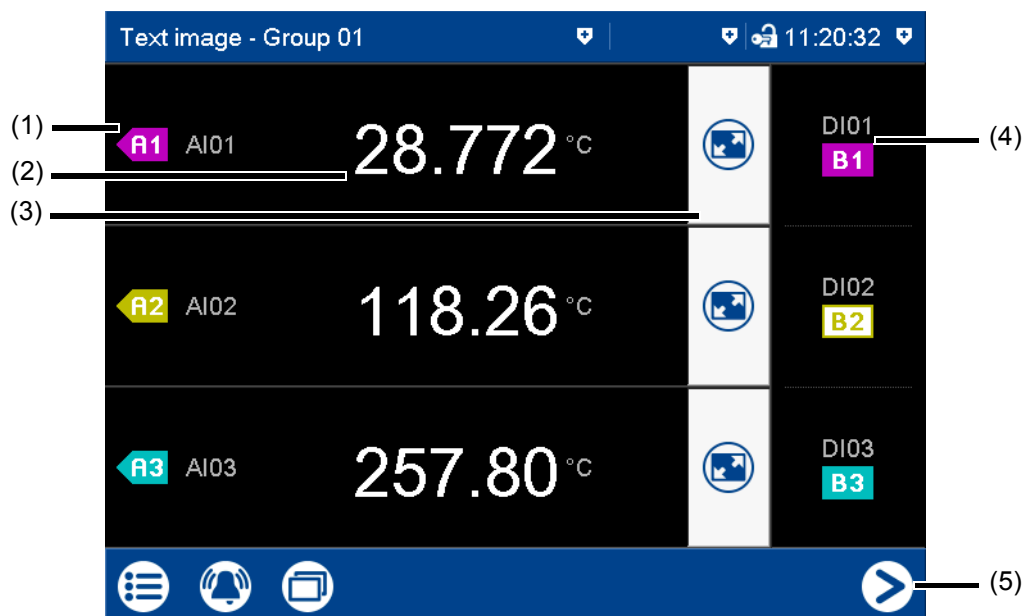

- | | |
|---|---|
| (1) Description (pointer) and short analog signal description (configurable) | (4) Digital signal with short signal description (configurable) and designation (pointer) |
| (2) Current value of analog signal | Displays the logical state:
Colored button = HIGH (B1, B3)
Colored frame = LOW (B2) |
| (3) Call up individual view of analog signal (numerical view and bar graph)
In the individual view, all digital signals of the group are also displayed. | (5) Go to next active group |

5 Operation

Individual view

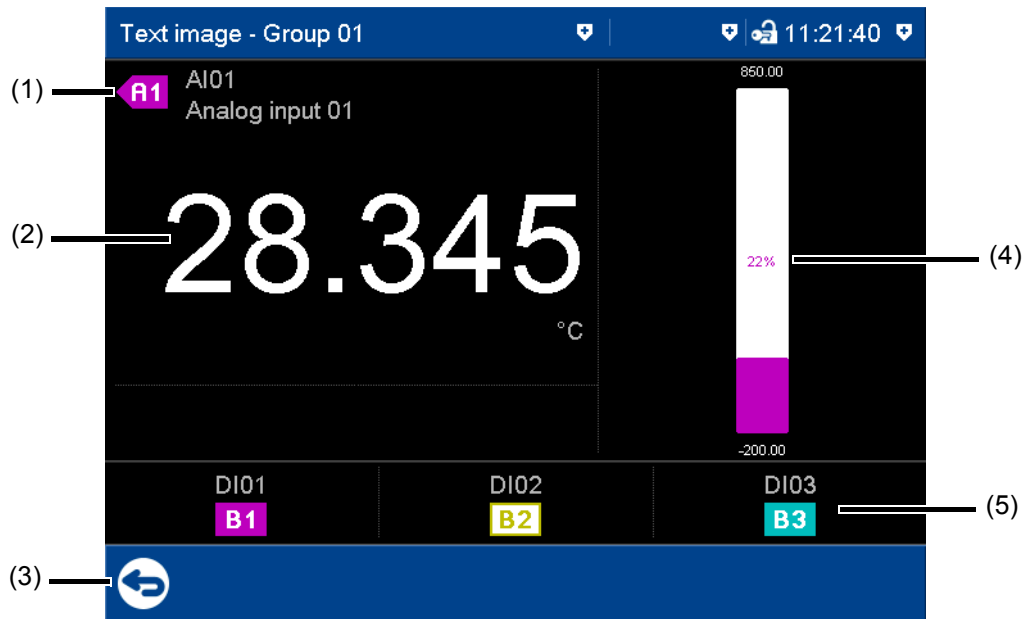

- (1) Designation (pointer), short signal description (configurable), and signal description (configurable) of the analog signal
- (2) Current value of the analog signal
- (3) Back to group view
- (4) Bar graph of the analog signal
- (5) Digital signal with short signal description (configurable) and designation (pointer)
Displays the logical state:
Colored button = HIGH (B1, B3)
Colored frame = LOW (B2)

Individual view with alarms

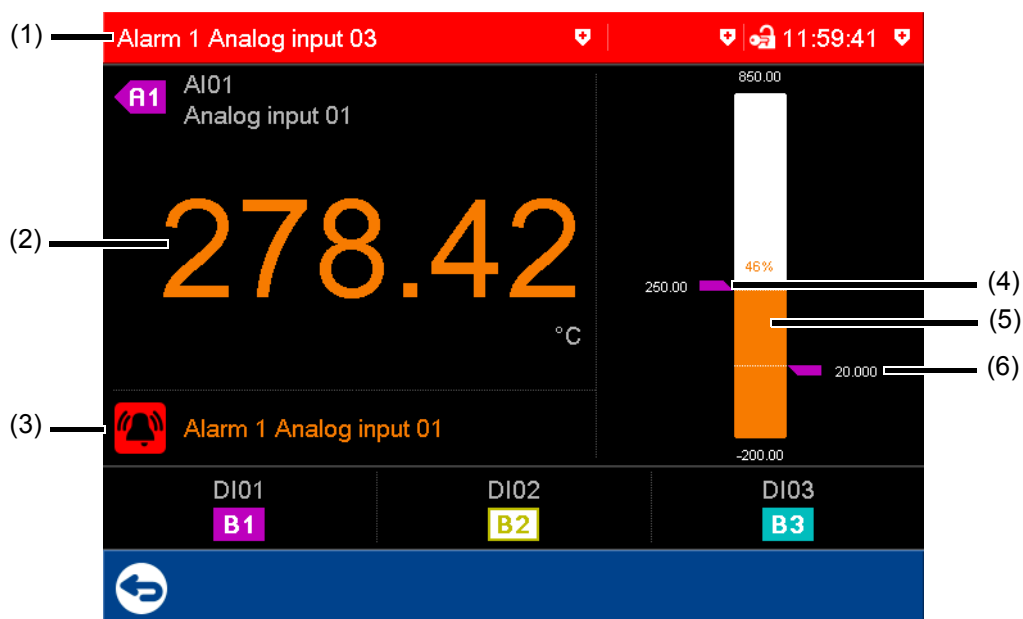

- | | | | |
|-----|--|-----|--|
| (1) | Last alarm to have occurred (here: from analog input 03) | (4) | Limit value for max. alarm (configurable) |
| (2) | Current value of analog signal with color change (alarm) | (5) | Bar graph of analog signal with color change (alarm) |
| (3) | Alarm text of analog input | (6) | Limit value for min. alarm (configurable) |

5 Operation

5.4.5 Report



A report shows the statistical information for the relevant group. A report contains the maximum, minimum, and mean values of the analog signals during the recording time (the recording period is configurable). A distinction is made between the current (on-going) report and the completed report.

To create a report, it must be activated in the configuration for the relevant group.

View

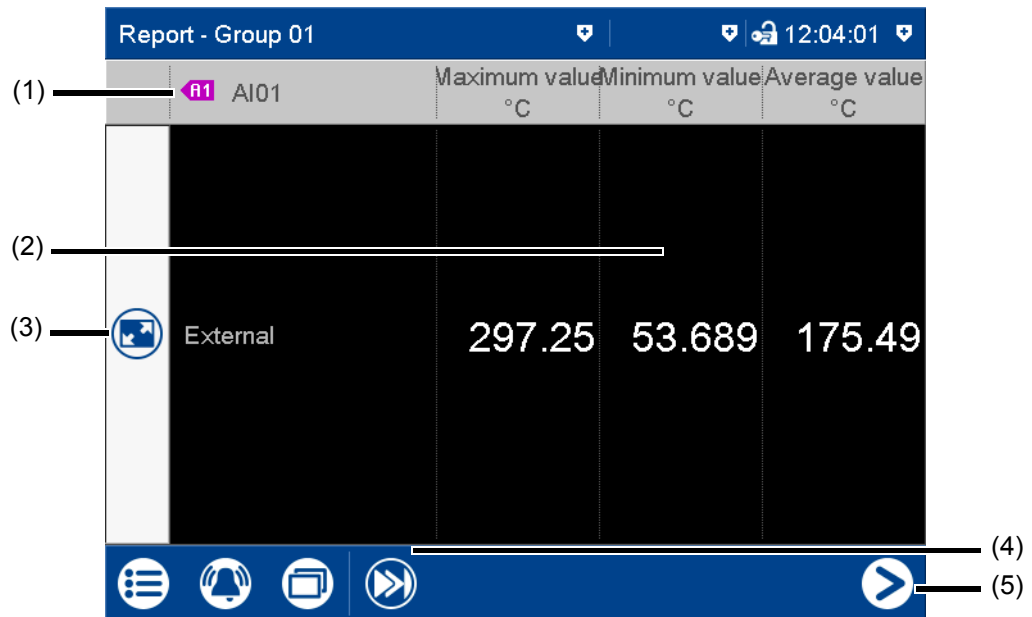

- (1) Description (pointer) and short analog signal description (configurable)
 - (2) Values of analog signal in the current (not completed) report
 - (3) Call up detailed view of analog signal
 - (4) Go to the next analog signal within the group
 - (5) Go to the report for the next group
- The type (configurable; here: external) decides when the report is stored and thus completed.

Detailed view

Report - Group 01		
External R1 AI01	Current °C	Completed °C
Maximum value	200.76	292.60
Time	08/24/2015 13:38:22	08/24/2015 13:37:51
Minimum value	84.126	80.773
Time	08/24/2015 13:38:18	08/24/2015 13:37:40
Average value	114.45	174.49
Timestamp start	08/24/2015 13:38:13	08/24/2015 13:37:23
Timestamp end	08/24/2015 13:38:34	08/24/2015 13:38:10

- | | |
|--|-------------------------------|
| (1) Description (pointer) and short analog signal description (configurable); report type (configurable; here: external) | (4) Completed report |
| (2) Time at which the max. value (or min. value) occurred | (5) Current (on-going) report |
| (3) Time stamp for current report: beginning of recording and current time
Time stamp for completed report: beginning and end of reporting period | (6) Back to previous view |

5 Operation

5.4.6 Current batch



This function opens the protocol for the current batch recording. Batch recording can be started and stopped (depending on the configuration).

The protocol layout is defined in the batch configuration. This is where the individual lines of the protocol are defined, and the text for the left column, and content of the right column, are specified (Device: Main menu > Configuration > Batch > Batch line x; see also the "Configuration" chapter in the operating manual).

⇒ Chapter 7.21 "Batch", page 172

View

Actual batch - Batch 1		13:43:33
Program name	Text 1	(3)
Customer info	Text 3	(2)
Batch name	Text 5	
Batch number	000000020Text 7	(4)
Batch start	08/24/2015 13:43:08	
Batch end	08/24/2015 13:43:32	
Batch duration	00:25	

- (1) Left column
- (2) Right column
- (3) Editable text (depending on the configuration)
- (4) Batch number and non-editable text (depending on the configuration)
- (5) Stop/start batch recording (only for configured "Batch start via touchscreen")

5.4.7 Completed batch



This function displays the report for the completed batch recording. Recorded data can be shown as a report and as a curve diagram.

If necessary, the report can also display the data from current batch recording.

View

Completed batch - Batch 1	
Program name	Text 1
Customer info	Text 3
Batch name	Text 5
Batch number	000000012Text 7
Batch start	07/27/2016 09:48:15
Batch end	07/27/2016 09:48:23
Batch duration	00:09

(1)							(2)
							(3)

(1) Open report (statistical information for the completed batch recording, and, if necessary, the current batch recording)

(2) Open curve presentation (analog curves and digital traces of the completed batch recording)

(3) Rendering electronic signature or display information about rendered signature

Electronic signature

With extra code 888 (FDA) and with the corresponding configuration in the PCS software the completed batch can be provided with an electronic signature. The signature can only be provided once per completed batch; it cannot be revoked. If a signature was provided already then this state is displayed through the following symbol (3):

Any user who has the corresponding authorization can sign the signature ("Confirm batches, electronic signature" right). This can be another user than the one who is currently logged on. Configuration of the electronic signature: see operating manual, "Configuration – in the setup program only" chapter > "Electronic signature".

⇒ Chapter 9.6 "Electronic signature", page 218

Example of an electronic signature:

⇒ Chapter 5.8 "Electronic signature", page 67

5 Operation

Report for batch

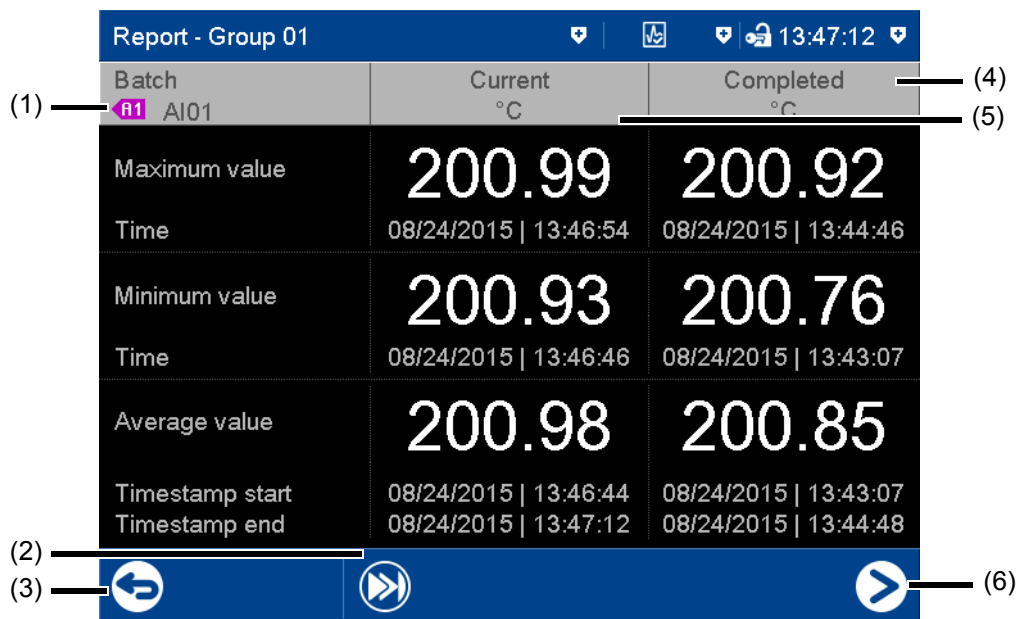

- (1) Description (pointer) and short analog signal description (configurable)
 - (2) Go to the next analog signal within the group
 - (3) Back to the batch report view
 - (4) Data (statistical information) for the completed batch recording
 - (5) Data (statistical information) for the current (on-going) batch recording
 - (6) Go to next group
- ⇒ Chapter 5.4.5 "Report", page 52

Curve presentation for the batch

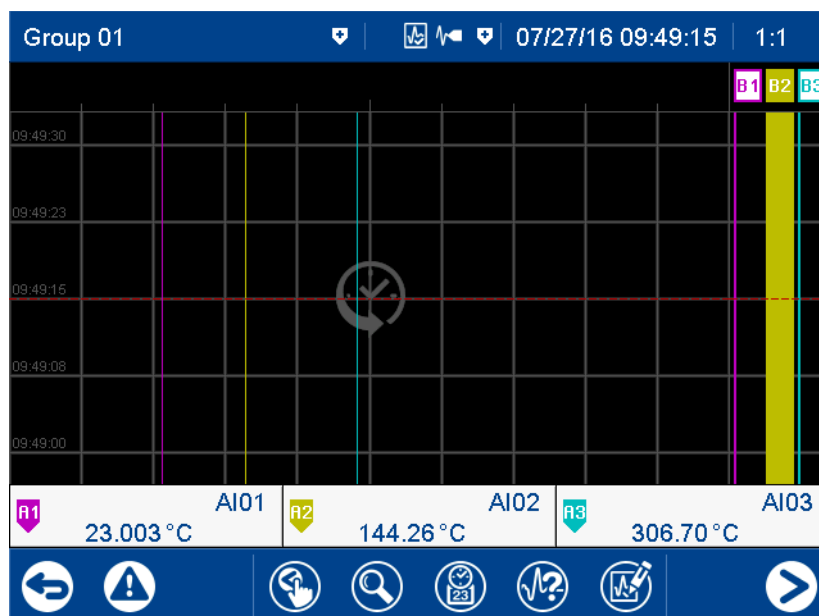

The functions are identical with those of the memory display in the "Curve diagram" visualization.

⇒ Chapter 5.4.1 "Curve diagram", page 44

When opening the curve presentation, the zoom factor is computed so as to display the data of the entire batch recording on the screen.

5.4.8 Process screen



This visualization shows the individual process screens. You can use the arrow keys in the navigation bar to change to the next process screen.

Up to 6 process screens can be created with the setup program and uploaded to the device. For a process screen to be displayed, it must be activated (configuration parameters in the setup program; see operating manual, chapter "Configuration - in setup program only" > "Process screens").

⇒ Chapter 9.10 "Process screens", page 227

5.4.9 Counter/Integrator



This visualization shows all activated counters/integrators. Up to 6 counters/integrators can be configured on the device.

View

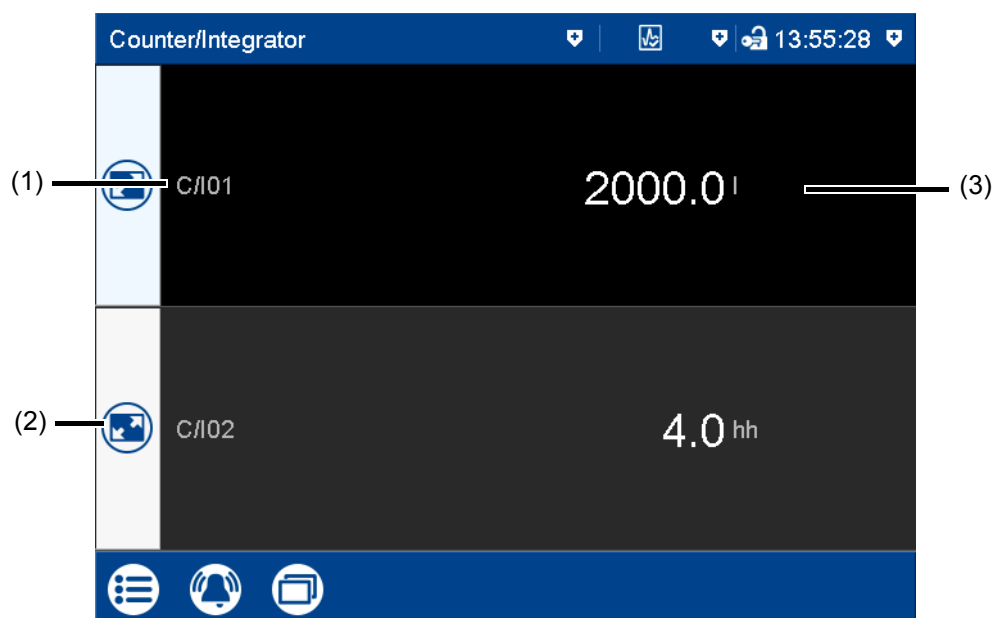

- (1) Short description (configurable) of the counter/integrator
- (2) Open detailed view of the counter/integrator
- (3) Current status of the counter/integrator (unit configurable)

5 Operation

Detailed view

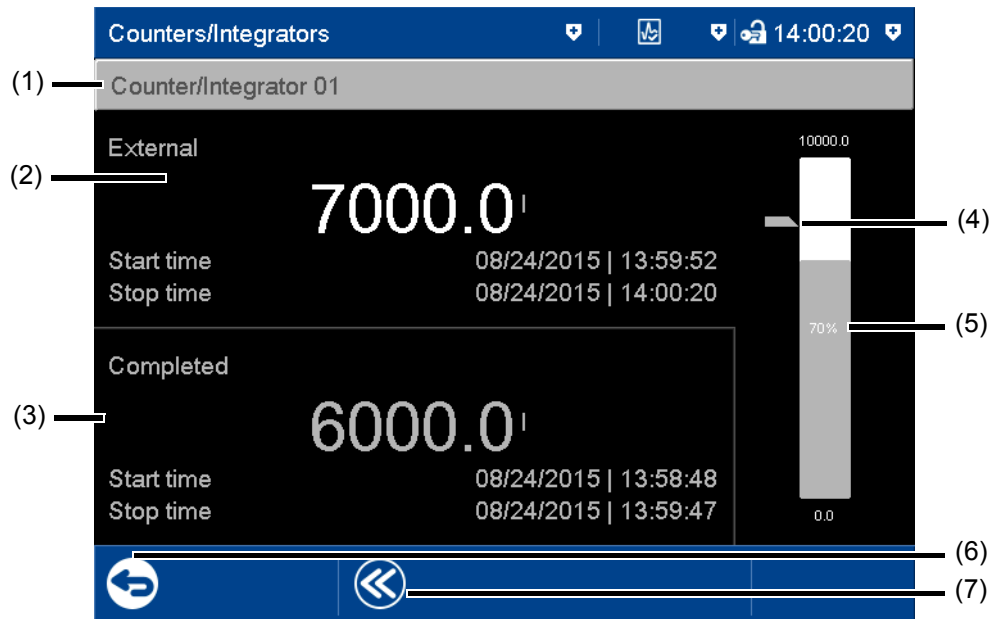

- | | |
|--|--|
| (1) Description (configurable) of the counter/integrator | (4) Limit value for max. alarm (configurable) |
| (2) Details of current counter/integrator
The type (configurable; here: external) decides when the status of the counter/integrator is stored and thus completed. | (5) Bar graph view of the current counter/integrator
Start and end of the display range are configurable. |
| (3) Details of the completed counter/integrator | (6) Back to view of all activated counters/integrators |
| | (7) Display of the last 7 completed batch/counter readings |

5.4.10 Comment text



This function can be used to enter a text (max. 160 characters) that is entered after completing the entry in the event list.

⇒ Chapter 5.5 "Text input dialog", page 59

The comment text is either assigned to the concerned group or all groups. The assignment depends on the current visualization in which the device is in when the function is invoked.

With the following visualizations the comment text is assigned to all groups: current batch, completed batch, process screen, counter/integrator

With the following visualizations the comment text is only assigned to the concerned group: curve diagram, digital diagram, bar graph, text image, report

The assignment to a certain group applies when only the event list of a certain group is displayed (memory presentation, curve presentation of the completed batch). In addition, the PCA3000 PC evaluation software can filter the events according to groups.

Comment with authentication

Depending on the "Comment with authentication" parameter (as of device version 02), user ID and password are required to enter a comment text (see operating manual, chapter "Configuration - in the setup program only" > "User list" > "Password rules").

⇒ Chapter 9.2.2 "Password rules", page 204

With a device that has extra code 888 (FDA) the concerned setting is performed with the PCS software.

The approach when entering a comment with authentication basically corresponds to the one when rendering an electronic signature for a completed batch (only steps 2 to 4).

Example of an electronic signature:

⇒ Chapter 5.8 "Electronic signature", page 67

5.5 Text input dialog

The text input dialog is used for all functions in which the user can enter or edit text.

Example: Configuration of an analog input

Analog input 1		14:02:06
Channel designation	AI01	(1)
Channel description	Analog input 01	(2)
Sensor	Inactive	(3)
Temperature input		
Unit		
Linearization		
Resistance measuring range		
Measuring range-Start		
Measuring range-End		

(1) Text editable (max. 5 characters)

(3) Drop-down menu (text not editable)

(2) Text editable (max. 21 characters)

Tap the text box to edit the text.

5 Operation

Text input dialog

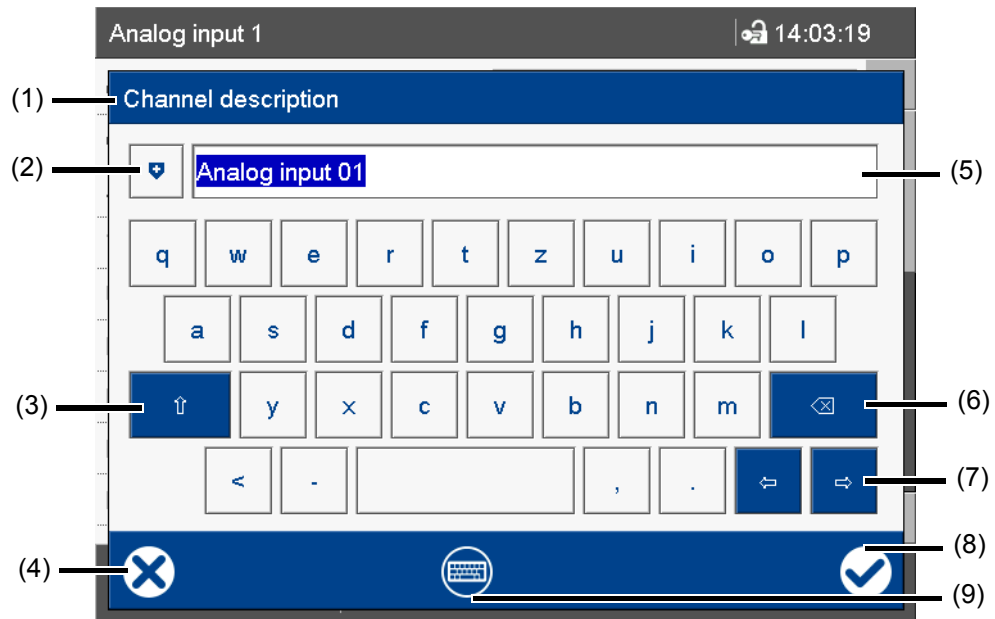

- | | |
|--|--|
| (1) Parameters (description of the configuration parameter from the previous dialog) | (5) Input box with current text
After changing to the text input dialog, the current text is fully selected. Tapping on the input box displays a cursor. Tapping and dragging the cursor lets you select multiple characters. |
| (2) Open text list (history of last 20 text entries)
The text from the list replaces the text in the input box. | (6) Backspace key
The character to the left of the cursor is deleted. If multiple characters are selected, they are deleted. |
| (3) Shift key (toggle to the second level of the current keyboard layout, e.g., upper-case)
To hold, you need to press the key for longer. To reset, (briefly) press the key again. | (7) Cursor keys (move cursor left or right) |
| (4) Cancel text entry (input is not applied) | (8) Complete text entry (input is applied) |
| | (9) Toggle keyboard layout (letters, digits, non-standard characters, for example) |

Keyboard mappings

Each of the 30 keys in the default keyboard layout can be mapped with up to 10 characters. The Shift key toggles between the first two characters. To select more characters, you need to hold down the relevant key for longer. This displays a selection window in which you can select the desired character by tapping.

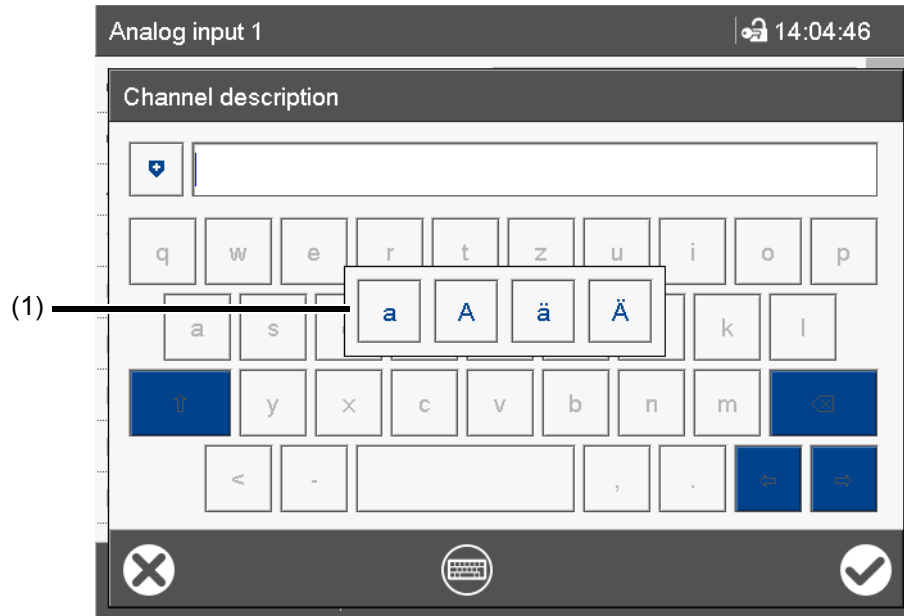

- (1) Multiple assignment of the "a" key
To leave the selection window without selecting a character, tap on the screen outside of the selection window.

More examples of multiple assignments of individual keys:

q Q @
s S ß
< > | '

Keyboard layout

The "Keyboard layout" key enables you to switch between the various keyboard layouts (keyboard assignments) (e.g., letters, digits, non-standard characters).

In the default keyboard layout (e.g., letters), each key can be assigned up to 10 characters. In the other keyboard layouts, only one character per key is possible.

The keyboard can be assigned individually for each language with the setup program (max. 6 layouts).

5 Operation

5.6 Flash manager

The Flash manager menu automatically opens when the device is in basic status and a USB flash drive (FAT16/FAT32 file system) is plugged into the front USB port. If the device is in a menu (main menu, alarm-/event list, display), the Flash manager is opened only after leaving the menu.

Device dialog

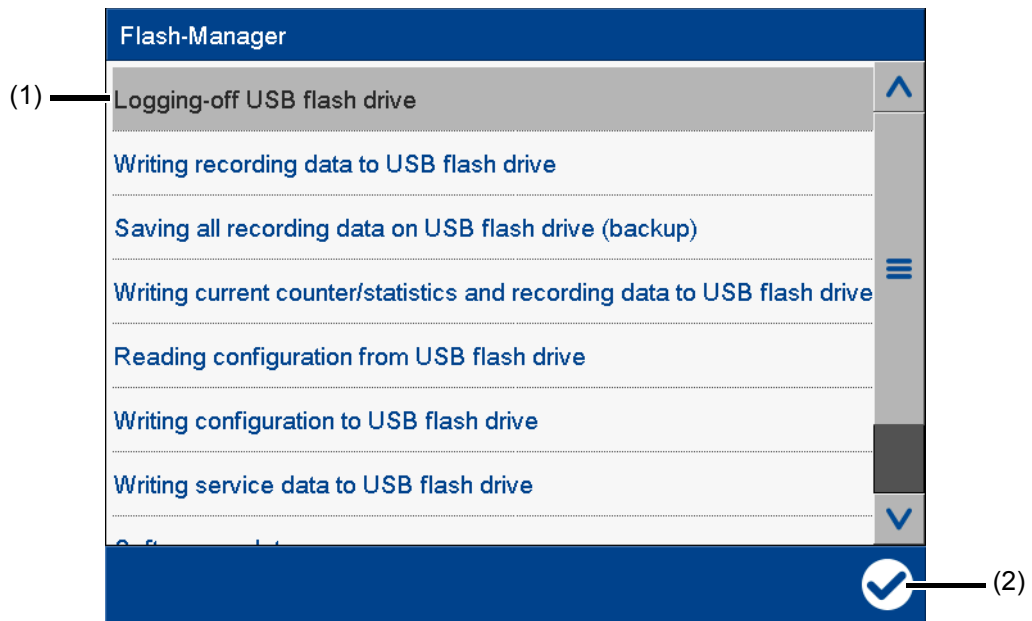

- (1) Flash manager functions
The selected function is grayed out.
- (2) "Apply" button

The Flash manager provides functions for transferring specific data between the device and a USB flash drive. The available functions depend on the logged in user's rights, or on the public rights. The selected function is performed by pressing the "Apply" button (check mark).



CAUTION!

Do not remove the USB flash drive without ejecting it. There is a risk of losing data. Before removing the USB flash drive, make sure to run the "Logging-off USB flash drive" function. Do not remove the USB flash drive until you see the "Hardware can now be removed!" message.

Flash manager functions

- **Logging-off USB flash drive:**
Function for safely removing the USB flash drive to avoid data loss
- **Writing recording data to USB flash drive:**
Any recorded data not yet backed up is written to the USB flash drive (retrieving the data). When this function is called up again, only the newly-added recorded data since the last run is transferred to the USB flash drive.
- **Saving all recording data on USB flash drive (Backup):**
All recorded data available on the device (including previously backed up data) is transferred to the USB flash drive (data backup). This function can take up to 30 minutes to com-

plete.

Device version 01: When you run the "Writing recording data to USB flash drive" function after this, only the newly-added recorded data is transferred to the USB flash drive.

As of device version 02, the user can choose a time period from which the recording data is saved. The "Total" time period corresponds to the previous function. For the other time periods (1 day, 1 week, 4 weeks) the determined starting time is displayed and updated (see example further down). Here, the user can also choose any starting time in the past. Using parameter "Save counters/reports" it is possible to save the current readings of the counters and integrators as well as the statistic (report) – even when they have not yet been completed – along with the recording data.

- **Writing current counter/statistics and recording data to USB flash drive:**
The current counter and integrator statuses, as well as the statistics (report) are read out, and written to the USB flash drive along with the newly recorded data.
- **Reading configuration from USB flash drive:**
The configuration data (except the user list) is transferred from the USB flash drive to the device. This reconfigures the device and data recording is restarted.
- **Writing configuration to USB flash drive:**
The configuration data (incl. the user list) is transferred from the device to the USB flash drive.
- **Writing service data to USB flash drive:**
Internal service data is transferred to the USB flash drive and can be sent to the device manufacturer for diagnosis.
- **Software update:**
Function for updating the device software; the USB flash drive must contain specific data provided by the device manufacturer.
- **Reading user list from USB flash drive:**
The user list is transferred from the USB flash drive to the device and activated.



CAUTION!

Data loss due to software update.

A software update deletes all recorded data stored on the device (incl. counters/integrators and statistics).

Before updating the software, back up the recorded data on a USB flash drive.

5 Operation

Save recording data of a certain time period

In the following example the recording data of a week should be saved.

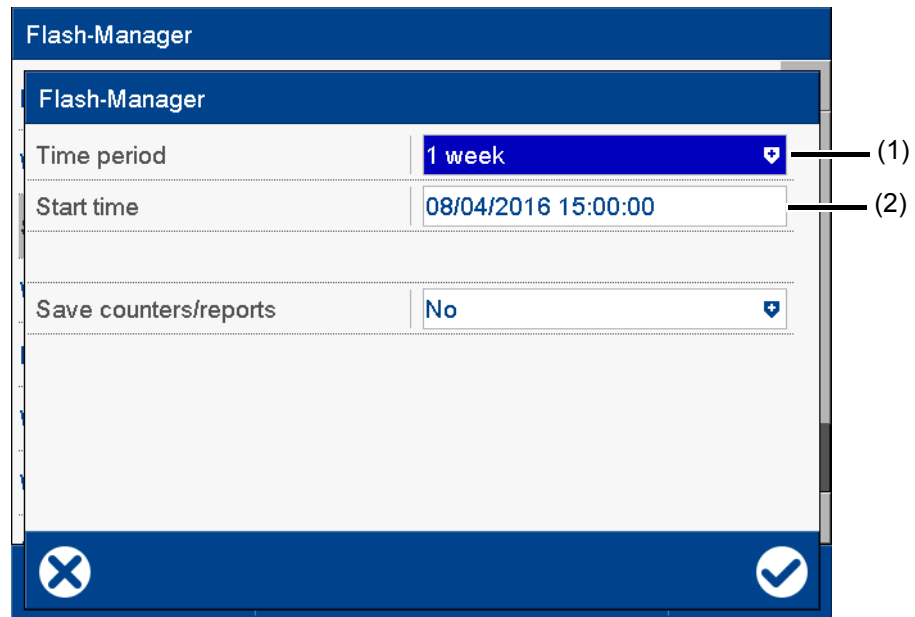

The screenshot shows the 'Flash-Manager' application window. It contains a form with the following fields:

- Time period:** A dropdown menu with '1 week' selected. A callout line labeled '(1)' points to this field.
- Start time:** A text input field containing '08/04/2016 15:00:00'. A callout line labeled '(2)' points to this field.
- Save counters/reports:** A dropdown menu with 'No' selected.

At the bottom of the window, there are two circular icons: a blue 'X' on the left and a white checkmark on a blue background on the right.

(1) Select time period

(2) Determined starting time (editable)

The starting time of the device is automatically determined depending on the current date (here it is: August 11, 2016), the current time (here it is 15:00:00), and the selected time period. This time can be changed by the user.



NOTE!

The recording data that is saved in the device is organized into data blocks of 20 kB each. The result can be that even data that was recorded prior to the started time is saved.

5.7 Web server

The device includes a built-in web server which supports online visualization with the help of a web browser. The user can access the process values, various visualizations, and the device's alarm and event list.

For access, you need to enter the device's IP address in the address line of the web browser. If needed, you can also use the DNS device name.

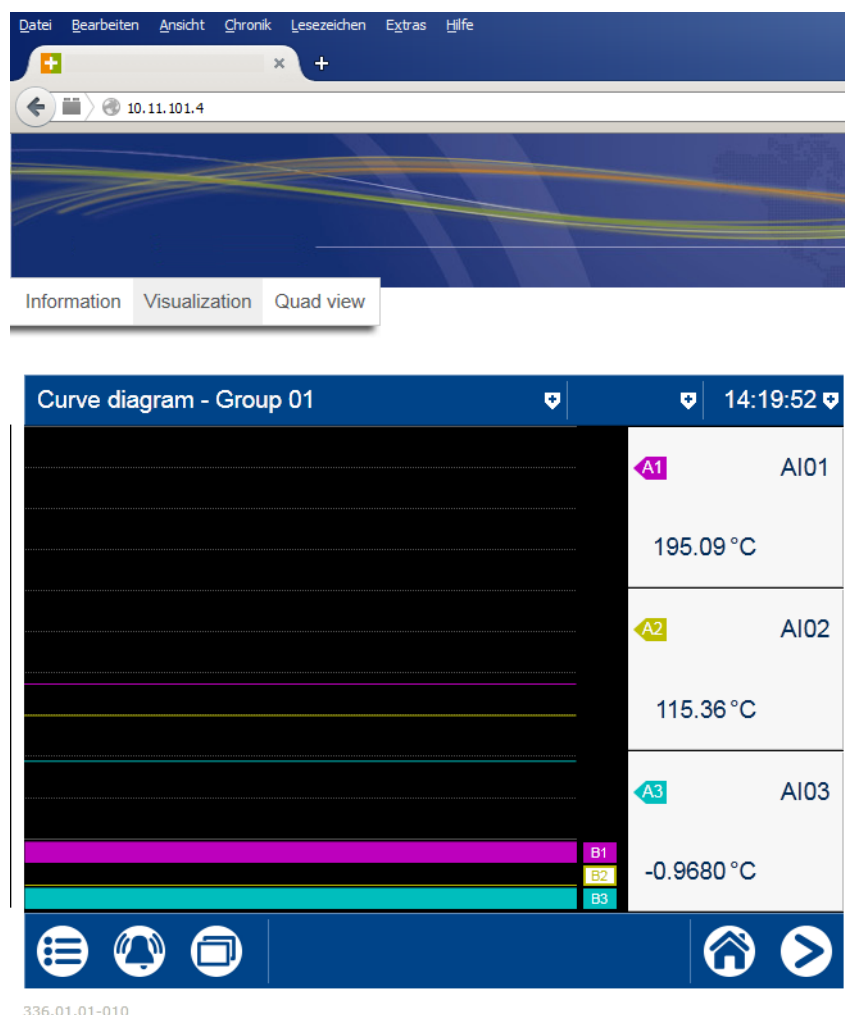

The start page, index.htm, exists by default; more HTML pages can be transferred to the device using the setup program. To prevent unauthorized access, you can enable a logon procedure with user name and password.

The web server is configured with the setup program (see the operating manual chapter "Configuration - in setup program only" > "Web server").

⇒ Chapter 9.5 "Web server", page 215

The web server is also enabled with the setup program (see the operating manual chapter "Configuration" > "Device": Version of online visualization):

⇒ Chapter 7.4 "Device", page 94

5 Operation



NOTE!

The view depends on the web browser you use.

Supported web browsers: Microsoft® Internet Explorer¹, Mozilla Firefox²

¹ Microsoft® and Internet Explorer are registered trademarks of Microsoft® Corporation.

² Mozilla and Firefox are registered trademarks of the Mozilla Foundation.

5.8 Electronic signature

As of device version 02 and with extra code 888 (FDA), the user has the option to provide a completed batch or the recording data of a certain time period with his/her electronic signature. A logged-on user can provide his/her signature during logoff – it applies to the entire time period for which the user was signed in.

The prerequisites for the electronic signature are the device-dependent settings in the PCS software as well as the related user right.

Completed batch

The following example shows the electronic signature of a completed batch.

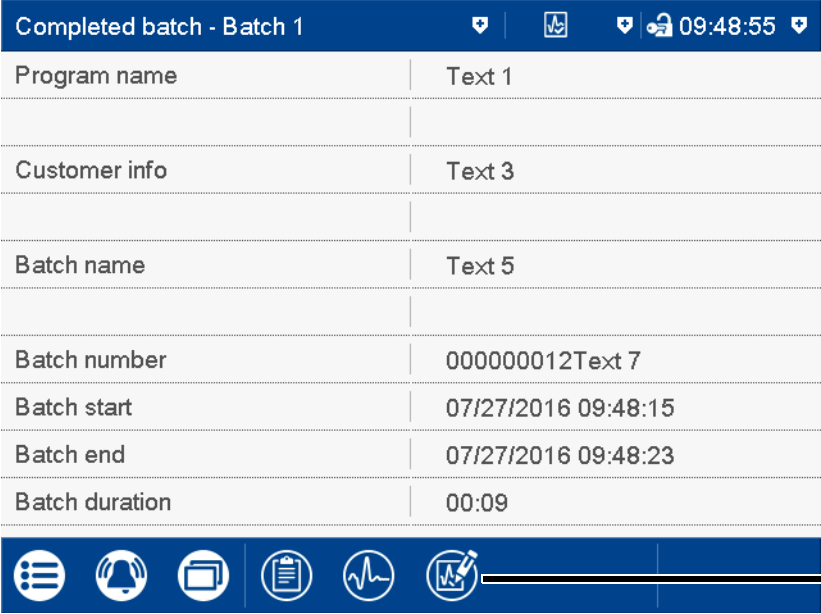
Step	Activity																
1	<p>In the protocol of a completed batch recording press the button (1) for the electronic signature:</p>  <table border="1" data-bbox="523 819 1347 1431"> <thead> <tr> <th colspan="2">Completed batch - Batch 1</th> </tr> </thead> <tbody> <tr> <td>Program name</td> <td>Text 1</td> </tr> <tr> <td>Customer info</td> <td>Text 3</td> </tr> <tr> <td>Batch name</td> <td>Text 5</td> </tr> <tr> <td>Batch number</td> <td>000000012Text 7</td> </tr> <tr> <td>Batch start</td> <td>07/27/2016 09:48:15</td> </tr> <tr> <td>Batch end</td> <td>07/27/2016 09:48:23</td> </tr> <tr> <td>Batch duration</td> <td>00:09</td> </tr> </tbody> </table>	Completed batch - Batch 1		Program name	Text 1	Customer info	Text 3	Batch name	Text 5	Batch number	000000012Text 7	Batch start	07/27/2016 09:48:15	Batch end	07/27/2016 09:48:23	Batch duration	00:09
Completed batch - Batch 1																	
Program name	Text 1																
Customer info	Text 3																
Batch name	Text 5																
Batch number	000000012Text 7																
Batch start	07/27/2016 09:48:15																
Batch end	07/27/2016 09:48:23																
Batch duration	00:09																

5 Operation

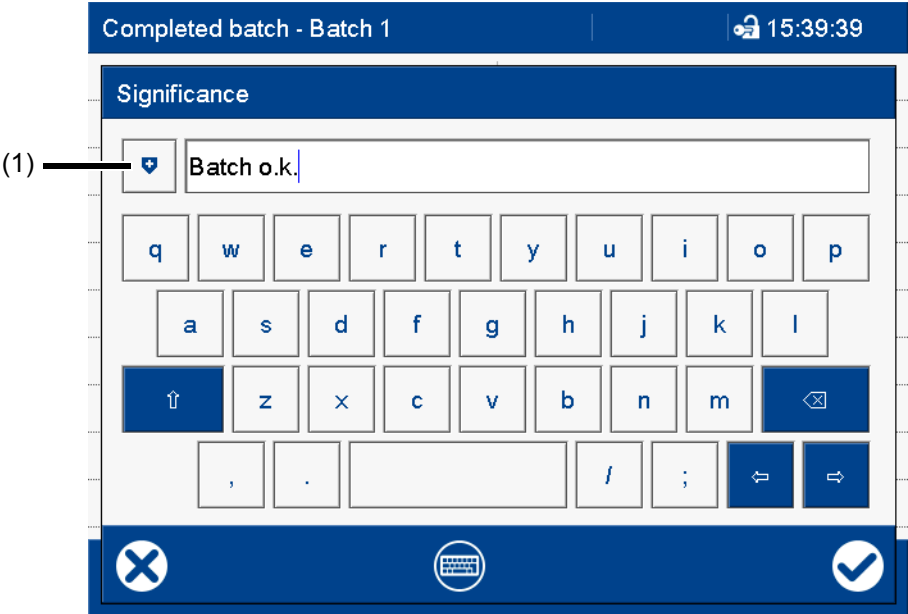
Step	Activity
2	<p>Select your user ID (in this case: Master)</p>  <p>The user has to select his/her ID. This step is required because someone other than the currently logged-on user can provide this signature.</p>
3	<p>Enter text that describes the meaning of the signature (evaluation text) using the keyboard. Alternatively, select text from the text list (1) and, if required, edit it:</p>  <p>The possibilities of entering a text depend on the configuration (no text available, enter text via keyboard, select text from text list, select text from text list and edit).</p>

Step	Activity
4	<p data-bbox="395 282 592 309">Enter password:</p> <div data-bbox="523 353 1347 963"> </div>
5	<p data-bbox="395 983 600 1010">Confirm process:</p> <div data-bbox="523 1055 1347 1664"> </div> <p data-bbox="395 1675 884 1702">The process can be still be aborted here.</p>

5 Operation

Step	Activity																		
6	<p>In the protocol of a completed batch recording press the button (1) to display the provided signature:</p> <div data-bbox="523 387 1347 996" style="border: 1px solid black; padding: 5px; margin: 10px 0;"> <div style="background-color: #0056b3; color: white; padding: 2px 5px; display: flex; justify-content: space-between; align-items: center;"> Completed batch - Batch 1 🔒 09:48:55 </div> <table border="1" style="width: 100%; border-collapse: collapse;"> <tr> <td style="padding: 2px;">Program name</td> <td style="padding: 2px;">Text 1</td> </tr> <tr> <td style="padding: 2px;">Customer info</td> <td style="padding: 2px;">Text 3</td> </tr> <tr> <td style="padding: 2px;">Batch name</td> <td style="padding: 2px;">Text 5</td> </tr> <tr> <td style="padding: 2px;">Batch number</td> <td style="padding: 2px;">000000012Text 7</td> </tr> <tr> <td style="padding: 2px;">Batch start</td> <td style="padding: 2px;">07/27/2016 09:48:15</td> </tr> <tr> <td style="padding: 2px;">Batch end</td> <td style="padding: 2px;">07/27/2016 09:48:23</td> </tr> <tr> <td style="padding: 2px;">Batch duration</td> <td style="padding: 2px;">00:09</td> </tr> </table> <div style="background-color: #0056b3; color: white; padding: 5px; display: flex; justify-content: space-between; align-items: center;"> ☰ 🔔 📄 📋 📊 📝 </div> </div> <p style="text-align: right; margin-right: 10px;">(1)</p> <p>➔ The signature (here: Master) and the meaning of the signature (here: Batch o.k.) are displayed.</p> <div data-bbox="523 1099 1347 1702" style="border: 1px solid black; padding: 5px; margin: 10px 0;"> <div style="background-color: #0056b3; color: white; padding: 2px 5px; display: flex; justify-content: space-between; align-items: center;"> Completed batch - Batch 1 🔒 15:43:19 </div> <div style="background-color: #0056b3; color: white; padding: 5px; margin-top: 5px;"> <p>Electronic signature</p> <table border="1" style="width: 100%; border-collapse: collapse;"> <tr> <td style="padding: 5px;">Signature</td> <td style="padding: 5px;">Master</td> </tr> <tr> <td style="padding: 5px;">Significance</td> <td style="padding: 5px;">Batch o. k.</td> </tr> </table> </div> <div style="background-color: #0056b3; color: white; padding: 10px; display: flex; justify-content: flex-end; align-items: center; margin-top: 10px;"> ✓ </div> </div>	Program name	Text 1	Customer info	Text 3	Batch name	Text 5	Batch number	000000012Text 7	Batch start	07/27/2016 09:48:15	Batch end	07/27/2016 09:48:23	Batch duration	00:09	Signature	Master	Significance	Batch o. k.
Program name	Text 1																		
Customer info	Text 3																		
Batch name	Text 5																		
Batch number	000000012Text 7																		
Batch start	07/27/2016 09:48:15																		
Batch end	07/27/2016 09:48:23																		
Batch duration	00:09																		
Signature	Master																		
Significance	Batch o. k.																		

Time period

The electronic signature for a time period essentially differs from the signature for the completed batch by requiring the time period in question to be selected.

The signature applies to the time period that is displayed in the diagram at the time of the signature. The displayed area may have to be expanded prior to signing. During signing the time period can only be reduced; an increase is then no longer possible.

Significance	
Signature	Master -
Significance	<input type="text"/>
Time period	
from	<input type="text" value="08/09/2016 15:44:14"/>
to	<input type="text" value="08/09/2016 15:44:50"/>

Logoff

The electronic signature during logoff requires no entry of the user ID as this function is only available for the user who is currently logged-on. The further steps, including entry of the password, correspond to those of the signature for the completed batches from step 3 (Enter text for meaning) to step 5 (Confirm process). The signature can only be evaluated with the PCA3000 software.

The signature applies to the entire time period for which the user was logged on.

5 Operation

The setup program is a PC software tool for convenient configuration of the paperless recorder; it offers the following functions:

- User-friendly program operation
- Support for multiple languages, both in the setup program and in the device (operating language)
- Activation of optional device features (extra code)
- Editor for creating process screens for the device
- Communication between the setup program and the device via Ethernet or USB device interface for transferring setup data and process data
- Display of process data for selected signals (online data)

6.1 Installation

6.1.1 Hardware and software requirements

To install and operate the setup program, you need a PC with a CD/DVD drive, a USB host interface, and an Ethernet interface.

Use of interfaces:

⇒ Chapter 6.4.4 "Transfer setup file", page 88

Specifications on the supported operating system (Microsoft® Windows®¹) and the required hard disk drive and working memory are provided in the information on the setup program on the manufacturer's website (search for 706520, click on the link to the product in the search results, and follow the details for the setup program under Software).



NOTE!

The setup program is delivered on a CD; alternatively, it can be downloaded from the manufacturer's website.

6.1.2 Installing and starting the program

Installing the program



CAUTION!

Installing the setup program can interfere with running programs. This can cause loss of data. Quit all programs before starting the setup program installation.

Step	Activity
1	Insert the CD into the drive and close the drive.
2	After inserting the CD, the installation program automatically starts. If this does not happen, run the "Launch.exe" file in the main directory of the CD.
3	The installation program proceeds through the rest of installation accompanied by on-screen messages.
4	Read and accept the terms of the license agreement. Accepting the license agreement is a prerequisite to installing the setup program.

¹ Microsoft® and Windows® are registered trademarks of Microsoft® Corporation.

6 Setup program

Step	Activity
5	Enter the license number for the setup program (see CD sleeve; you may also need to enter license numbers for additional functions after installation). If you select the option "30-day trial version" during installation, the setup program is fully functional for 30 days (full user rights). After 30 days, the program automatically switches to a "demo version" in which some functions, e.g., data transmission, data storage, and printing are blocked. The software can be licensed at a later date. ⇒ Chapter 6.1.3 "Logon and rights", page 74
6	Specify a program folder in the Windows® start menu to which the icons for starting the software will be copied. The directory for the program files is automatically specified.
7	Press the INSTALL button to start the actual installation.

Starting the program

After completing the installation, the setup program can be started from the Windows® Start menu.

6.1.3 Logon and rights

Logging onto the setup program

The user name and password are not requested following initial installation of the setup program. The user is logged on initially as "Specialist" with a blank password. In the "**EXTRAS**" menu, the "**RENEW LOGON/CHANGE PASSWORD**" function can be used to activate this request when the program starts.

⇒ Chapter 6.3.4 "Extras", page 82

Activation of the logon function can be used to distinguish between the users "Specialist" and "Service". The two users have different rights regarding access to functions of the PC setup program.

If the request is active, the user must log on:

Step	Activity
1	Logging onto the program. 



NOTE!

The user is now logged onto the setup program but not the device. To log onto the device, the user again needs a user ID (e.g., Master) and the device password. This data must be entered in the device's connection list when setting up the connection to a device.

Rights in the setup program

Depending on the installation and logon, individual users have different rights in the setup program.

The differences are summarized in the following table.

6 Setup program

Right	Demo installation	Maintenance	Specialist
Write interface texts	-	X	X
New	X	X	X
Open	X	X	X
Save, Save As, Delete	-	X	X
Configure undocumented parameters	-	-	X
Export data to external mass storage (USB flash drive)	-	X	X
Import data from external mass storage (USB flash drive)	-	X	X
Print	-	X	X
Activate program options	X	-	X
Activate extra codes	-	-	X
Edit interface settings	-	X	X
Edit device settings	X	X	X
Delete device	-	-	X
Create new device	X	-	X

x = Right exists, - = Right does not exist

6 Setup program

6.2 User interface

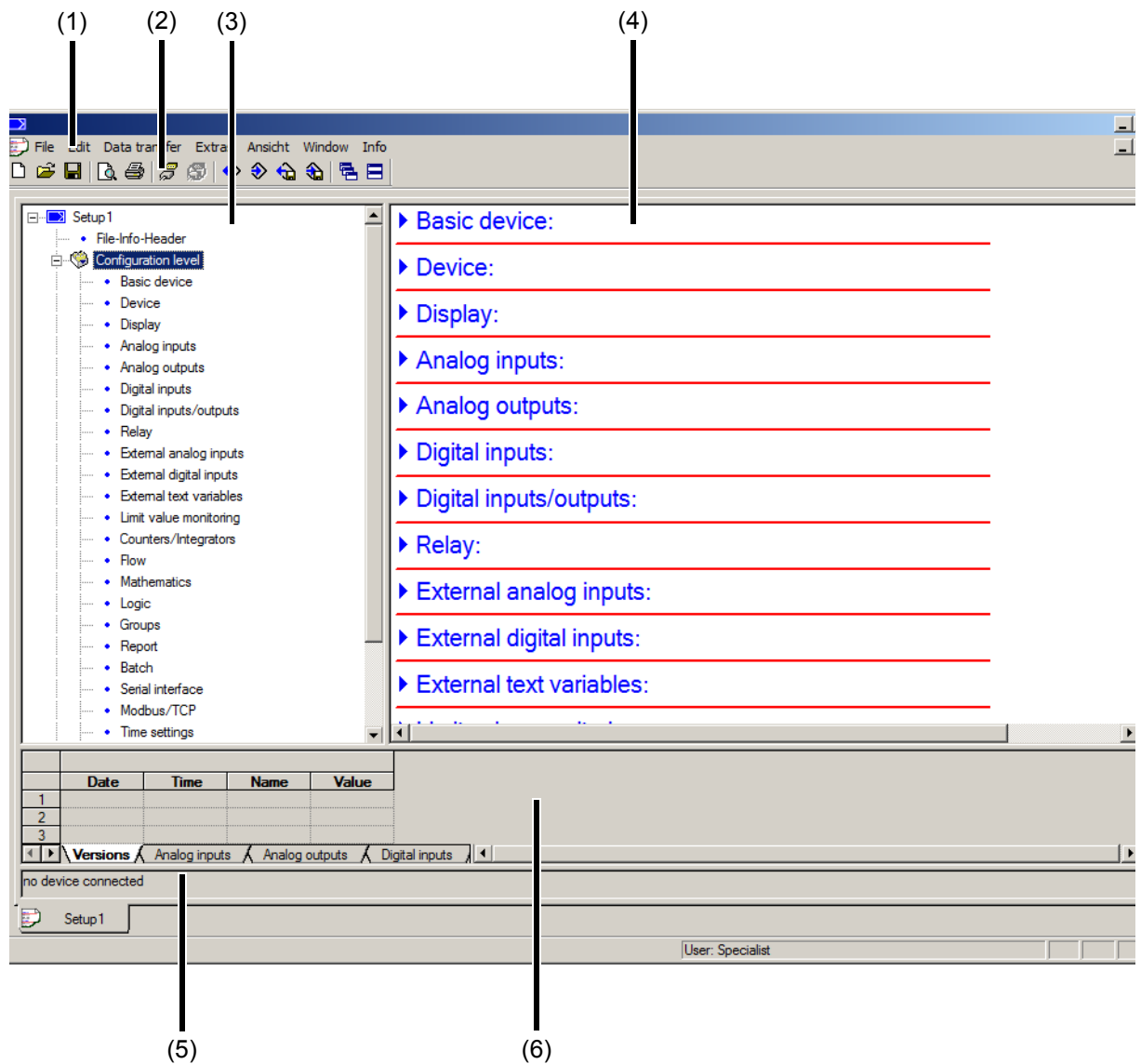

- (1) Menu bar
- (2) Toolbar
- (3) Work pane - Navigation tree
- (4) Work paneWork pane – Display window
- (5) Connection status
- (6) Online data

Menu bar

The menu bar can be used to start the individual functions of the setup program.

⇒ Chapter 6.3 "Menu bar functions", page 79



Toolbar

The toolbar contains selected functions from the menu bar. They can be started by pressing the left mouse button. Hovering the mouse pointer over one of the icons displays the name of the function after a few seconds.



Moving the toolbar

You can change the position of the toolbar:

Step	Activity
1	Position the mouse pointer between two icon groups. 
2	Press the left mouse button.
3	While holding down the left mouse button, drag the toolbar to the desired location.
4	Release the left mouse button. 

Possible positions of the toolbar:

- Along the left or right window border (vertical alignment)
- Below the menu bar (horizontal alignment),
- Along the lower edge above the user information (horizontal alignment)
- Any position (its own window - any alignment by changing the window size)

Closing the toolbar

If the toolbar has been moved, you can close it using the  button. To display the toolbar again, it must be activated in the **FILE > DEFAULT SETTINGS** menu, under **USER INTERFACE** (select checkbox). The toolbar then appears at the location to which it was previously moved.

Work pane

The work pane comprises the navigation tree (left) and the display window (right); it shows the current settings of a configuration file (setup file).

⇒ Chapter 6.4 "Setup file", page 85

The way the work pane is divided can be changed by moving the border between the navigation tree and display window sideways with the aid of the left mouse button.

6 Setup program

Connection status

The "Connection status" shows whether a connection to a device exists. In addition, some interface data are displayed, e.g., the IP address.

The line can also be shown and hidden using the **WINDOW > CONNECTION STATUS** function.

Example: No connection

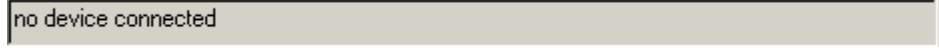

no device connected

Example: Connection to a device

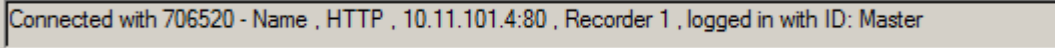

Connected with 706520 - Name , HTTP , 10.11.101.4:80 , Recorder 1 , logged in with ID: Master

The height of the line can be changed by moving the border of the online data window with the aid of the left mouse button.

Online data

The "Online data" function displays current process data in the setup program.

The online data window can also be shown and hidden using the **WINDOW > ONLINE DATA** function.

The height of the window can be changed by moving the border of the work pane or the "Connection status" line with the aid of the left mouse button.

Documentation (operating manual)

The operating manual of the device is available as a PDF document in the setup program when you press F1 for the Help function.

The document is opened with the program (PDF viewer), which is adjusted for files with the "PDF" extension for the relevant PC.

The language of the document depends on the language of the setup program (menu **FILE > DEFAULT SETTINGS ... > COUNTRY LANGUAGE OF PROGRAM**). The document is not available in all languages.

6.3 Menu bar functions

This chapter describes the menu bar functions. The order of the subchapters corresponds to the location of the menus in the menu bar (from left to right).

Functions that can also be called up via the toolbar are marked with the matching icon here.

6.3.1 File

Overview of menu items:

New	Ctrl+N
Open ...	Ctrl+O
Save	Ctrl+S
Save as...	
Close	
Export as RTF text	
Print ...	Ctrl+P
Print preview ...	
Printer setup...	
Default settings ...	
Last files ...	
Exit	

New



Creates a new setup file in the work pane.

The user can select from the following options:

- Manual (user-defined setting)
- Data import from external mass storage
- Via interface: Automatic detection of the connected device
- Via interface: Automatic detection and reading out of the configuration

Open ...



Opens an existing setup file and displays the content in the work pane.

Save



Saves the settings shown in the work pane in a setup file. The file name must only be entered once. If the file is saved again, the file name is no longer requested.

Save as ...

Saves the settings shown in the work pane in a setup file. In contrast to the "SAVE" function, a request for the file name always appears in this case.

6 Setup program

Close

Removes the settings shown in the work pane from the work pane and closes the Setup window. The user has the opportunity to save any changes that have not yet been saved.

Export as RTF text

Saves the current setting as an RTF file on the PC.

Print ...



Prints the setup settings. The menus to be printed can be selected beforehand.

Print preview (page view) ...



The print results are displayed on screen. Several pages can be displayed and the view can be scaled.

Printer setup ...

Allows the printer settings to be changed. When a program starts, the Windows® default printer is always used as the active printer.

Default settings ...

Allows the default settings of the setup program to be changed. Many changes become active only after restarting the setup program.

Last files ...

Displays the file names of the setup files last saved.

Clicking once on the file name opens the setup file or displays an already opened setup file as the active window.

Exit

Quits the setup program. The user has the opportunity to save changes that have not yet been saved.

6.3.2 Edit

Overview of menu items:

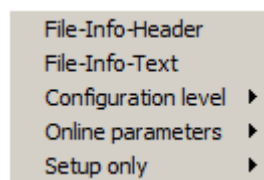

The menu items and their submenus correspond to the navigation tree in the work pane.

6.3.3 Data transfer

Overview of menu items:

Establish connection...	F2
Break connection...	Alt-F2
Data transfer to the device...	F5
Data transfer from the device...	Alt-F5
Data export to ext. mass storage	
Data import from ext. mass storage	

Establish connection ...



Opens the device connections list.

The device connections list contains all devices to which a connection can be established via the setup program. Devices can be added to or removed from the list.

The interface parameters for the connection are also configured in the device connections list.

Break connection ...



Terminates the connections of the active setup file.

Data transfer to the device ...



Sends the setup data to the device.

A connection to the relevant device is required. If there is no connection, the device connections list is opened automatically.

Data transfer from the device ...



Reads out the setup data from the device.

A connection to the relevant device is required. If there is no connection, the device connections list is opened automatically.

Data transfer to ext. mass storage ...



Transfers the setup file in SET format to external mass storage (USB flash drive).

Data transfer from ext. mass storage ...



Reads out a setup file from external mass storage (USB flash drive).

The setup settings are displayed in the work pane.

6 Setup program

6.3.4 Extras

Overview of menu items:

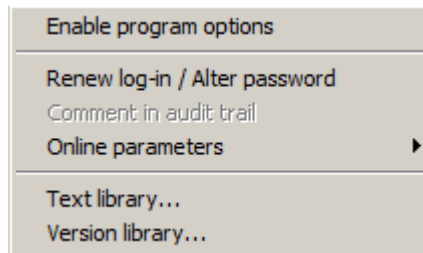

Enable program options

Activates optional functions of the setup program (entry of additional license numbers).

Using this function, the setup program can also be registered with a valid license number at a later date (30-day test version or full version) if a valid license number was not entered during the installation (demo mode).

Renew log-in/Alter password

Opens a window to activate user logon.

Following installation of the setup program, the user name and password are not requested when the program starts until the user logon is activated. The user is logged on initially as "Specialist" with a blank password.

This function activates the user and password request when the program starts and changes the current password.

Comment in audit trail

Creates a comment in the audit trail data of the setup program.

In devices with enhanced security requirements, audit trail data documents operator actions in the individual PC programs.

Online parameters

Allows access to the device's online parameters. An active connection to the device is required for this.

The online parameters are also available in the navigation tree.

Text library...

Opens a window for editing the text library.

The text library is used to manage the various control languages for the device (incl. online visualization).

⇒ Chapter 9.1 "Country settings", page 199

In various sub-menus, the **LANGUAGE >** button allows editing of the respective language.

Version library ...

Shows the content of the version library.

The list contains the default versions of the device software (incl. the web server) and the compatible hardware versions provided by the device manufacturer together with the PC setup program. Additional software versions that were imported subsequently (e.g., customer-specific versions) are also included.

6.3.5 View

Overview of menu items:

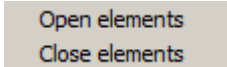

Open elements

Expands all elements in the work pane so that the sub-items and the settings can be viewed.

Close elements

Collapses all elements in the work pane.

6.3.6 Window

Overview of menu items:

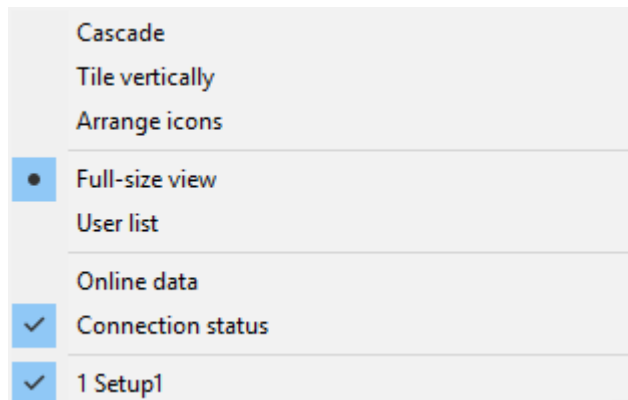

Cascade



Arranges all open setup windows in an overlapping arrangement. Left-clicking on a window brings it to the foreground.

Tile vertically



Arranges all open setup windows in a tiled arrangement. Left-clicking on a window makes it the active window.

Arrange icons

Arranges the icons for all minimized setup windows in the lower area of the user interface. This function has an effect only if an icon was previously moved out of the lower region.

Full-size view

The work pane contains all functions of the setup program.

User list

The work pane contains only the "User list" function. Only the user table (user id and name, password, group assignment) is transferred to the device. The condition is that the user groups in the device and in the setup file are identical.

6 Setup program

This function is not available for a device with extra code 888 (FDA; as of device version 02).

Online data

Alternately shows/hides the online data window.

A check mark preceding the menu item indicates that the window is shown.

Connection status

Alternately shows/hides the line for displaying the connection status.

A check mark preceding the menu item indicates that the line is shown.

Opened window (here: Setup 1)

Displays the names of all opened setup files as a list.

Clicking on the name in the list makes the associated window the active window. A check mark preceding the name indicates the active window.

In the example shown here, only one setup file is open; it is named "Setup 1".

6.3.7 Info

Overview of menu items:

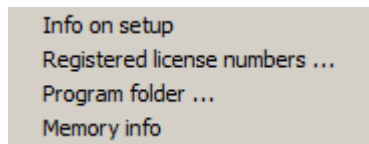

Info on setup

Displays information about the setup program, incl. the version number.

The version number is important, for instance, when contacting the service hotline.

Registered license numbers ...

Shows all registered license numbers and any active options.

The license numbers and the information about active options are important, for instance, when contacting the service hotline.

Information about obtaining a fee-based license number can be found on the manufacturer's website (see software download of setup program).

Program folder ...

Shows the various folders (directories) that are being used on the hard drive or in the network by the setup program.

To display the contents of the folder, click the button (on the right next to the folder path).

Memory info

Displays the memory information.

The memory information is intended for use in diagnostics. It is requested when needed by the device manufacturer's service technician.

6.4 Setup file

The setup file contains full details of the device's hardware and software, as well as its configuration.

The function **FILE > NEW** or **FILE > OPEN** creates a new setup file, or opens an existing file.

6.4.1 Views and functions

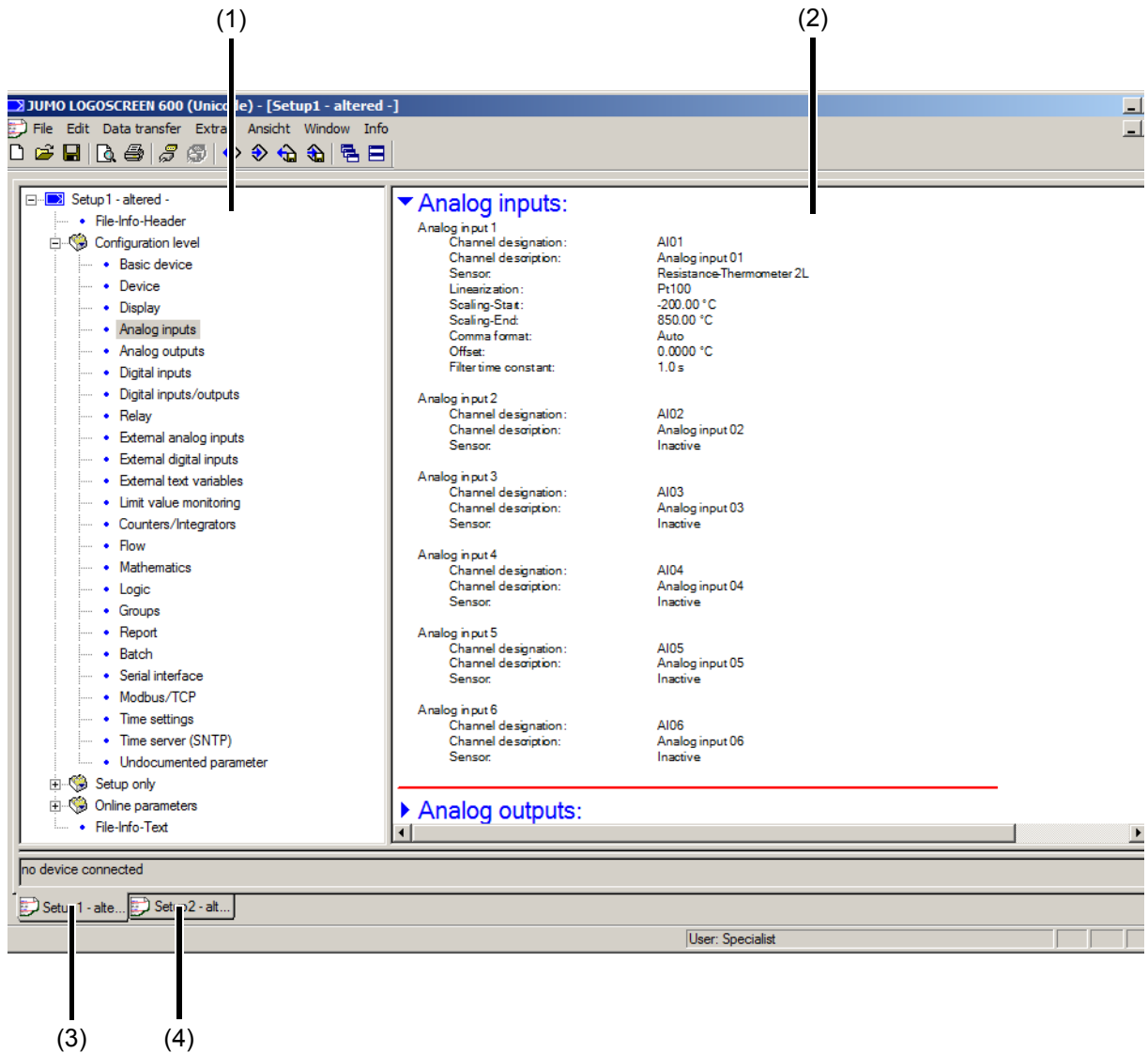

- (1) Navigation tree
Shows the areas and the sub-items
- (3) Active setup window

- (2) Display window
Shows the sub-items and their settings
- (4) Inactive setup window

6 Setup program

Navigation tree

Clicking on the (" - ") icon zooms out of the view; clicking on the (" + ") icon zooms back in. Double clicking an entry (e.g., "Analog inputs") starts the change dialog. Alternatively, you can initiate changes via the menu bar (**EDIT>CONFIGURATION LEVEL>ANALOG INPUTS**).

Display window

Double clicking an entry in the view window starts the change dialog. Clicking on the ("right arrow") in front of an entry lists the current settings in the view window; clicking on the ("down arrow") hides these settings again.

Setup window

If several setup windows are open simultaneously, clicking once on the name at the lower edge of the inactive window (here: "Setup 2...") makes it the active window.



Right mouse button functions

If you right-click in the navigation tree or display window, you have access to various context-dependent functions. The functions relate to the entry to which the mouse pointer is pointing when pressing the right button.

Example:

You press the right mouse button on the "Analog inputs" entry.

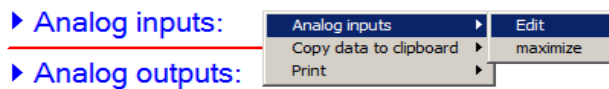

Analog inputs > Edit

The function starts the change dialog for configuring the analog inputs.

The change dialog can also be started by double clicking with the left mouse button.

Analog inputs > Maximize

This function shows you the current configuration of the analog inputs.

Alternatively, you can view the current configuration by left clicking the ("right arrow").

Copy data to clipboard > Analog inputs

The function copies the current configuration of the analog inputs to the Windows® clipboard (RTF format). The clipboard content can be used in an editor or text processing program, for example.

Copy data to clipboard > All data

This function copies the entire current configuration - not just the analog inputs - to the Windows® clipboard (RTF format). The clipboard content can be used in an editor or text processing program, for example.

Print

This function enables the current settings to be printed. You can choose which parameter groups to print and which not to print. Alternatively, printing is also possible via the **FILE** menu.

6.4.2 Create file info

The file info consists of the **file info header** and the **file info text**; and is used to describe the setup file. The information is only stored in the setup file and not transferred to the device.

The file info header and file info text can be directly called up via the corresponding menu entry in the navigation tree or view window.

Setup dialog

Parameters

Parameters	Selection/settings	Description
File info header		
Short info	Enter text	Description of the setup file in short form
Programmer	Enter text	Name of programmer
Type code	Enter text	Order code
Job	Enter text	Order number
Extra info	Enter text	Additional information
File info text		
File info text	Enter text	Exhaustive description of the setup file

6 Setup program

6.4.3 Create configuration

The device configuration is divided into three areas in the setup program:

- Configuration level
- Setup only
- Online parameters

The individual parameters and their settings are described in the relevant chapters of this operating manual.

Configuration level

⇒ Chapter 7 "Configuration", page 89

Setup only

⇒ Chapter 9 "Configuration – in setup program only", page 199

Online parameters

⇒ Chapter 10 "Online parameters", page 247

6.4.4 Transfer setup file

To transfer the setup file, you first need to open a connection between the setup program (PC) and the device.

A connection is possible via:

- Ethernet interface (TCP/IP)
- USB device interface

To use the Ethernet interface, the device must have an IP address.

If DHCP is supported on the network and enabled on the device, the IP address is assigned automatically by the network.

The assignment of the IP address and other required settings in this context can also be performed manually.

⇒ Chapter 7.22 "Ethernet", page 177

The USB device interface is needed if there is no network, or no IP address was assigned.



NOTE!

The USB device interface is not intended for a permanent connection, since unintentional removal of the USB connector cannot be prevented due to the lack of a captive connection.

Establish connection

Function in the menu bar: **DATA TRANSFER > ESTABLISH CONNECTION ...**

If you wish to establish a connection (or start data transfer without an existing connection), the setup program opens the device connection list. The device connection list contains all the devices for which a connection has been configured. Users can add connections to new devices, change the features of existing connections (interface parameters) as well as remove connections.

The "Use connection settings assistant" function assists the user with creating a new entry, i.e. a new connection, and with editing existing entries.

To create a connection, select the desired device in the device connection list and then press the  button.

This chapter describes the paperless recorder configuration based on the menu items and parameters of the device: **MAIN MENU > CONFIGURATION**

The description also applies for the configuration with the setup program.



NOTE!

The configuration on the device is only available if a user is logged on, and the user has the required rights.

Parameters within a menu item that only exist on the device or in the setup program are marked as "(device only)" or "(setup only)".

Beyond this, there are functions that can only be configured with the setup program. These functions are described in separate chapters:

⇒ Chapter 9 "Configuration – in setup program only", page 199

⇒ Chapter 10 "Online parameters", page 247

Default settings are shown in **bold** in the parameter tables.

7.1 Edit texts during configuration

Certain texts, such as the channel designations, can be modified directly during the configuration.

In the setup program, the user can enter or change text in one, several, or different languages after pressing the (1) "Language" button. All languages that exist in the country settings are available for selection.



(1) Language

In the device, the text can only be changed in the currently selected language.

7 Configuration

7.2 Selectors

Selectors contain signals that are available for configuration on the device or in the setup program. These are device signals (e.g., analog and digital inputs or internal signals), and signals that are transferred to the device via Modbus (external analog and digital inputs; as of device version 02 also writable via barcode).

7.2.1 Analog selector

Category	Signal	Description
No selection		No signal selected
Analog inputs	Analog input 1 to 6	Analog input signal
External analog inputs	Ext. analog input 1 to 24	Signal of external analog input (via interface)
Flow	Flow 1	Current flowmeter reading
Counter statuses (current)	Counters (cur.) 1 to 6	Current value of counter or integrator
Counter statuses (completed)	Counters (compl.) 1 to 6	Value of counter or integrator in most recently completed capture period
Math results (analog)	Math (analog) 1 to 6	Results of math formula

7.2.2 Digital selector

Category	Signal	Description
No selection		No signal selected
Digital inputs	Digital input 1 to 12	Signal of digital input
Digital inputs/ outputs	Digital input/output 1 to 12	Signal of digital input
External digital inputs	Ext. digital input 1 to 24	Signal of external digital input (via interface)
Math results (binary)	Math (binary) 1 to 6	0 = Math result is valid 1 = Math result is invalid (computation error, also for substitute value output)
Logic results	Logic 1 to 6	Results of logic formula
Alarms digital inputs	Alarm digital input 1 to 12	Alarm signal of the digital input
Alarms digital inputs/ outputs	Alarm digital inputs/ outputs 1 to 12	Alarm signal of the digital input
Alarms analog inputs	Alarm 1 analog input 1 to 6	Alarm signal from alarm 1 of the analog input
	Alarm 2 analog input 1 to 6	Alarm signal from alarm 2 of the analog input
Alarms ext. digital inputs	Alarm ext. digital input 1 to 24	Alarm signal of external digital input

7 Configuration

Category	Signal	Description
Alarms ext. analog inputs	Alarm 1 ext. analog input 1 to 24	Alarm signal from alarm 1 of the external analog input
	Alarm 2 ext. analog input 1 to 24	Alarm signal from alarm 2 of the external analog input
Logic alarms	Alarm logic 1 to 6	Alarm signal of logic formula
Alarms math	Alarm 1 math 1 to 6	Alarm signal from alarm 1 of math formula
	Alarm 2 math 1 to 6	Alarm signal from alarm 2 of math formula
Signals limit value monitoring	Status limit value monit. 1 to 6	Status signal of limit value monitoring
Alarms limit value monitoring	Alarm limit value monit. 1 to 6	Alarm signal of limit value monitoring
Alarms flow	Alarm 1 flow 1	Alarm signal from alarm 1 of flow metering
	Alarm 2 flow 1	Alarm signal from alarm 2 of flow metering
Alarms counters/integrators	Alarm 1 counter/integr. 1 to 6	Alarm signal from alarm 1 of counter or integrator
	Alarm 2 counter/integr. 1 to 6	Alarm signal from alarm 2 of counter or integrator
Alarms groups	Upper tol. alarm gr. 1 to 4	Upper tolerance band alarm signal of group
	Lower tol. alarm gr. 1 to 4	Lower tolerance band alarm signal of group
	Alarm group 1 to 4	Collective alarm of group

7 Configuration

Category	Signal	Description
System alarms	Collective alarm	Collective alarm of device The signal is active if the alarm list contains at least one entry (an entry is removed as soon as the alarm disappears).
	Collective alarm with acknowledgment	Collective alarm of device; active until acknowledged The signal is activated for each new entry in the alarm list; it remains active until acknowledged (even if the entry has disappeared from the alarm list).
	Memory alarm	The signal is active if the data was not read out in time and the free internal memory drops below the memory alarm limit value (Configuration > Device).
	Battery discharged	Battery alarm (buffer battery is discharged and must be replaced) Notify service department! Caution: RAM memory content may get lost!
	Battery weak	Battery pre-warning (buffer battery can be replaced within 4 weeks without data loss) Notify service department!
	User logged on	Signal is active when a user is logged on.
	USB flash drive active	This signal is active if a USB flash drive is plugged in and active.
	Temp. unit °F device	This signal is active if the temperature unit of the device is configured as "Degrees Fahrenheit" (Configuration > Device).
	Temp. unit °F interface	This signal is active if the temperature unit of the interface is configured as "Degrees Fahrenheit" (Configuration > Device).
	The following "Slave timeout ..." signals are active if the device is acting as a Modbus slave, timeout monitoring is enabled, and no request is received from the Modbus master within the configured period (Configuration > Serial interface; Configuration > Modbus/TCP).	
	Slave timeout Com1	(for Modbus via serial interface)
	Slave timeout Com1 inv	(as above, inverted signal)
	Slave timeout TCP1	(for Modbus/TCP, master 1)
Slave timeout TCP1 inv	(as above, inverted signal)	
Slave timeout TCP2	(for Modbus/TCP, master 2)	
Slave timeout TCP2 inv	(as above, inverted signal)	
Digital signal batch	Batch active	Signal active when batch reporting is active

7.3 Basic device (setup only)

This menu item is used to change device hardware (optional plug-in boards) and optional functions (extra code, e.g., math/logic) in the current setup project. The following options are available for this purpose:

- User-defined creation: Device hardware and optional functions are selected by the user in the setup program.
- Automatic detection: Device hardware and optional functions are read out from the connected device and transferred to the setup program.
- Automatic detection with read out of setup file: The configuration is additionally read out from the device here and transferred to the setup program.

Setup dialog

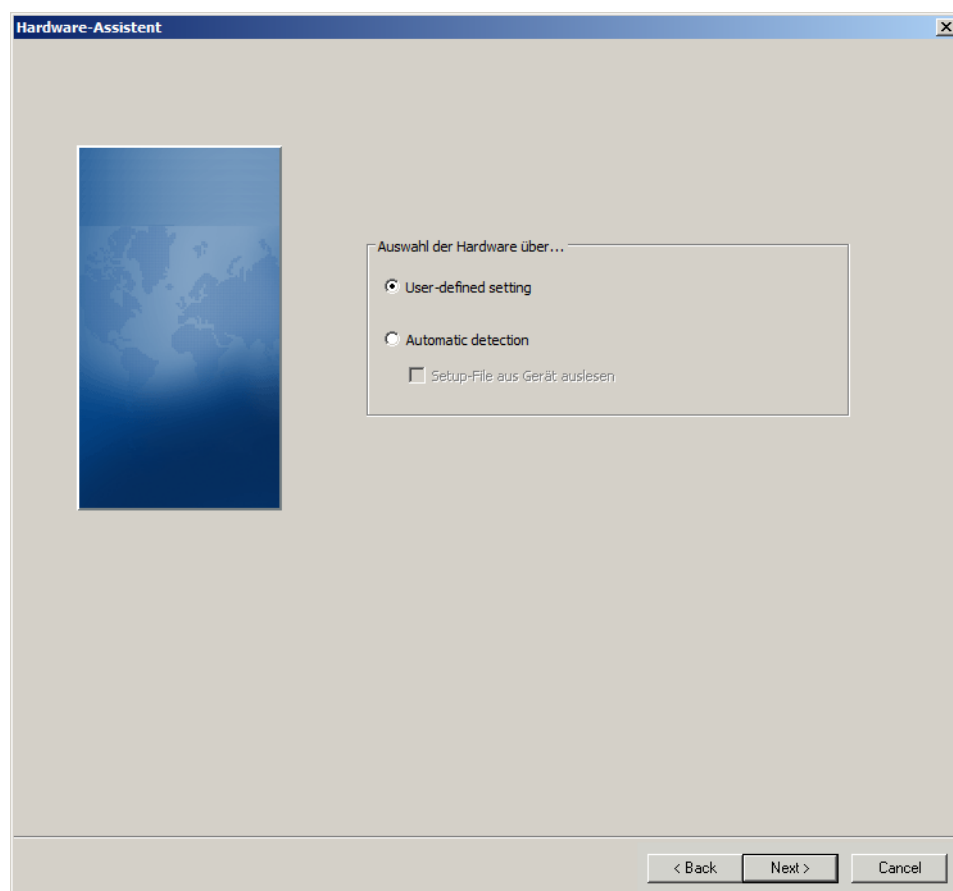

7 Configuration

7.4 Device

The general device data is configured in this menu.

Device dialog

Device		10:05:38
Device name	<input type="text" value="Name"/>	
Language	English	
Temperature unit device	Degrees Celsius	
Temperature unit interface	Degrees Celsius	
Memory alarm limit value	<input type="text" value="20 %"/>	

Parameters

Parameters	Selection/settings	Description
Device name	Name (example) (max. 20 characters)	The device name is used in the setup program, web server, and the PCC and PCA3000 PC programs.
Language	Language 1: English (example) Select language (drop-down menu).	Language of display texts (max. 15 languages) All texts for a language can be changed using the setup program. This is also where the language order is defined. The first 15 languages are available on the device.

7 Configuration

Parameters	Selection/settings	Description
Country settings after power on (setup only)	Yes (<input checked="" type="checkbox"/>) , No (<input type="checkbox"/>)	<p>If "Yes," is selected, the user can configure settings immediately after switching on the device the next time. The parameters are then automatically reset to "No" in the device so that no settings occur after switching back on again. The parameter is not automatically reset in the setup file.</p> <p>This parameter can also be set in the parameterization: ⇒ Chapter 8.6 "System data", page 198</p> <p>The country settings are also configured after switching on the device for the first time as part of the startup.</p>
Temperature unit device	Unit in which the temperature values are entered and displayed. When the unit is changed, all the relevant values are converted and the display is adjusted.	
	Deg. Celsius	Unit = °C
	Deg. Fahrenheit	Unit = °F
Temperature unit interface	Unit of the temperature values transferred to the interface (external analog inputs). However, the "Temperature unit device" unit is authoritative for displaying the values. The values transferred via the interface are converted if needed.	
	Deg. Celsius	Unit = °C
	Deg. Fahrenheit	Unit = °F
Memory alarm limit value 	0 to 20 to 100 %	If the free memory of the measurement-data memory drops below the limit value, a memory alarm is triggered.
Version Online Vis. (setup only)	Version of the web server function for viewing process data with a web browser via the HTTP protocol (visualizations at control level)	
	No online visualization	Web server inactive
	Standard online visualization	Default version
	336.01.01.10 (example)	Other versions may be available here.
Display protection (setup only)	Password to prevent displaying configuration data in the setup program. Without password (default setting), the configuration data is always displayed. If a password is set, and input incorrectly, the configuration is not displayed; however, it can be transferred from the setup program to the system and also read out from the system.	
	***** (Enter password)	Password (max. 16 characters; case sensitive)
Setup quick info (setup only)	Enter text (max. 20 characters)	<p>Brief description of the setup project</p> <p>The text is transferred to the device, stored there and displayed below "Device info".</p>

7 Configuration

Parameters	Selection/settings	Description
Setup info (setup only)	Enter text (max. 500 characters)	Exhaustive description of the setup project The text is transferred to the device, stored there, and displayed below "Device info".

Memory alarm limit value

**CAUTION!**

If the data are not read by the user in time:
There is a risk of data loss once the memory alarm has been triggered.
Read the data immediately.

7.5 Display

The following data is configured in this menu:

- Screen settings
- Colors of the individual items of information in the visualizations
- General settings for the various visualizations

7.5.1 Start image and watermark (setup only)

Setup dialog

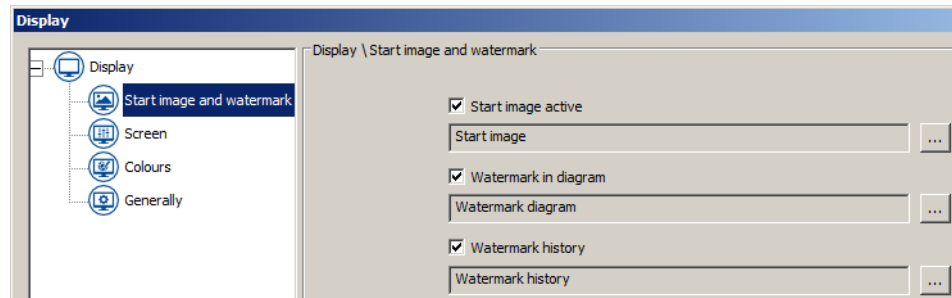

Parameters

Parameters	Selection/settings	Description
Start image active	Yes (<input checked="" type="checkbox"/>) , No (<input type="checkbox"/>) Users can press the "... " button to import and export a start image.	The start image is active if "Yes" is selected. The image is displayed after power on during the initialization phase. Fixed size: 640 × 480 pixels
Watermark in diagram	Yes (<input checked="" type="checkbox"/>) , No (<input type="checkbox"/>) Users can press the "... " button to import and export a watermark.	If "Yes" is selected, a watermark that runs through the background is shown in the curve diagram. Maximum size: 100 × 200 pixels
Watermark history	Yes (<input checked="" type="checkbox"/>) , No (<input type="checkbox"/>) Users can press the "... " button to import and export a watermark.	If "Yes" is selected, a watermark that runs through the background is shown in the curve diagram history. Maximum size: 100 × 200 pixels

7 Configuration

7.5.2 Screen

Device dialog

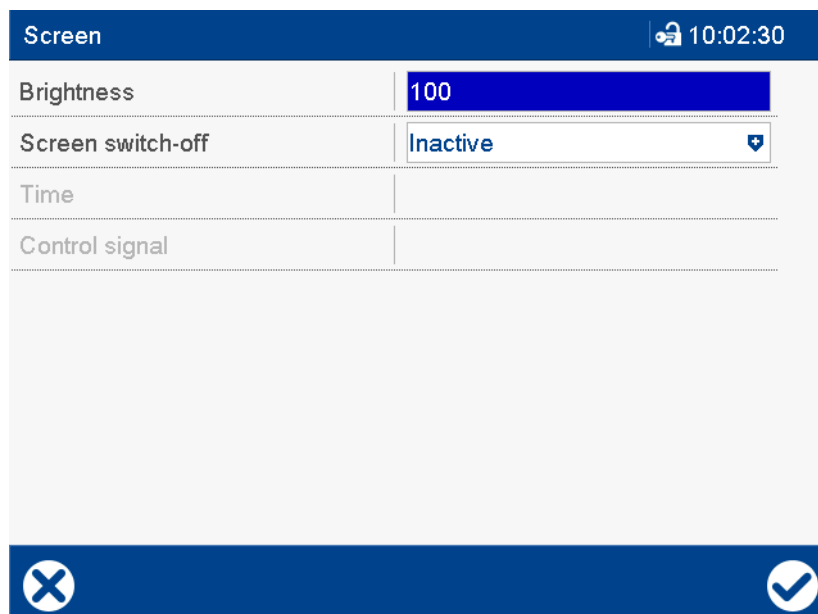

Parameters

Parameters	Selection/settings	Description
Brightness	0 to 100 %	Screen brightness
Screen switch-off	The screen can be switched off (darkened) to save energy. Inactive Time By control signal	The switch-off is not active. If the screen is not touched for a period from 10 to 32767 seconds, the switch-off is activated and the screen turns dark. The switch-off is activated by one of the digital signals (digital selector). A digital signal can be a digital input, a relay status, or a batch activation, for example.
Time	10 to 300 to 32767	Time in seconds for the screen switch-off
Controller signal	No selection Digital selector	No screen switch-off Signal (high active) for the screen switch-off when selecting the control signal

7.5.3 Colors

Device dialog (excerpt)

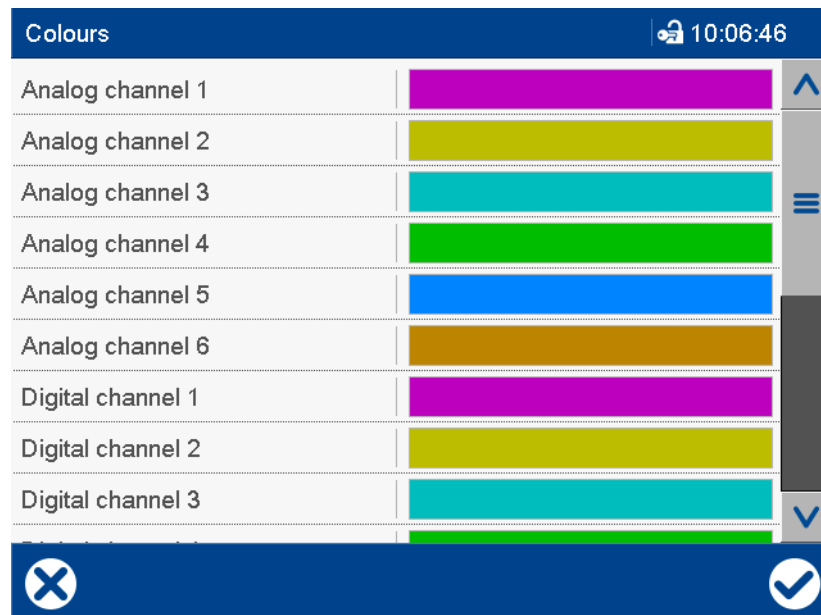

Parameters

Parameters	Selection/settings	Description
Analog channel 1 to analog channel 6	Color ...	Color used to display the corresponding analog channel (graphically, numerically, and in text form).
Digital channel 1 to digital channel 6	Color ...	Color used to display the corresponding digital channel (graphically, numerically, and in text form).
Analog curves background	Color ...	Background color for displaying the analog curves
Digital trace background	Color ...	Background color for displaying the digital traces
Alarm refer. curve	Color ...	Color used to display an analog channel when it leaves a tolerance band.
Alarm 1, Alarm 2	Color ...	Color used to mark the alarm in question.
Time stamp in diagram	Color ...	Color used to display the time information.
Grid lines in diagram	Color ...	Color in which the grid in the curve diagram is displayed.



7 Configuration

7.5.4 Generally

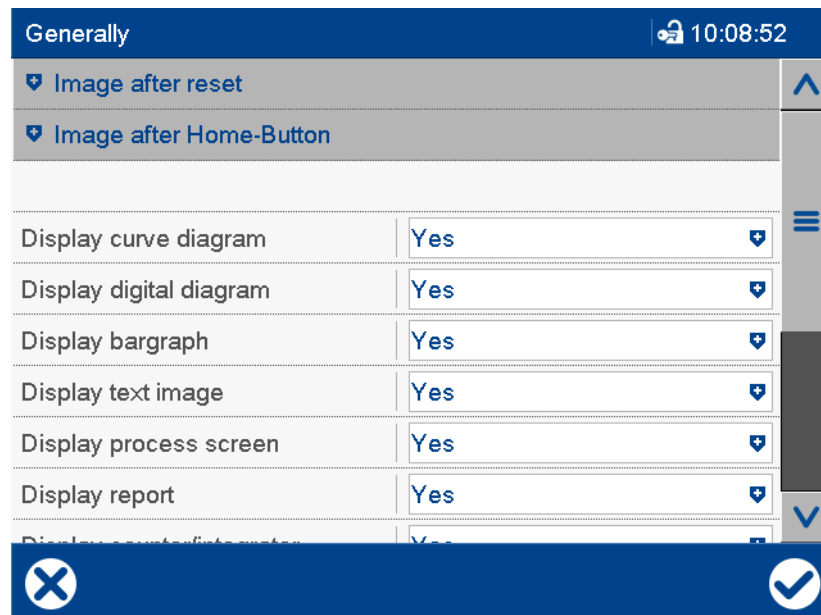
Device dialog (excerpt)



Parameters

Parameters	Selection/settings	Description
Image after reset:		
Last image before reset	Yes, No	If "Yes" is selected, the last active image before the reset (by rebooting or changing the configuration) is also displayed after the reset.
Image selection 	Curve diagram Select visualization.	Visualization after reset, if "Last image before reset" is not active. ⇒ Chapter 5.4 "Visualization menu (display)", page 43
Group selection	1 to 4	Group whose channels are displayed in the selected visualization.
Image after Home-Button:		
Home button active	Yes, No	If "Yes" is selected, the device changes to a specific visualization after pressing the Home button.
Image selection 	Curve diagram Select visualization.	Visualization after pressing the Home button ⇒ Chapter 5.4 "Visualization menu (display)", page 43
Group selection	1 to 4	Group whose channels are displayed in the selected visualization.
Generally:		
Display curve diagram	Yes, No	"Yes" releases the "Curve diagram" visualization for selection by the user.

7 Configuration

Parameters	Selection/settings	Description
Display digital diagram	Yes, No	"Yes" releases the "Digital diagram" visualization for selection by the user.
Display bar graph	Yes, No	"Yes" releases the "Bar graph" visualization for selection by the user.
Display text image	Yes, No	"Yes" releases the "Text image" visualization for selection by the user.
Display process screen	Yes, No	"Yes" releases the "Process screen" visualization for selection by the user.
Display report	Yes, No	"Yes" releases the "Report" visualization for selection by the user.
Display counters/integrators	Yes, No	"Yes" releases the "Counters/Integrators" visualization for selection by the user.
Display batch	Yes, No	"Yes" releases the "Current batch" and "Last completed batch" visualizations for selection by the user.
Input simulation 	Yes, No	If "Yes" is selected, all inputs and outputs of the device are ignored and pseudo data is displayed on the screen.
Display alarms	Yes, No	"No" rejects the display of fault and alarm messages in the status and title line.
Barcode -> Batch image	Yes, No	If "Yes" is selected, the "Current batch" visualization is automatically shown when the corresponding barcode is scanned.
Thousand separator	Yes, No	If "Yes" is selected, a stroke will be used in certain visualizations as an identification marking for numbers above and including 1000. Example: 215'892,9
Lock touchscreen	Lock the touchscreen to prevent use. This does not switch off the screen.	
	No selection Digital selector	Not locked Signal (high active) with which the touchscreen (screen) is locked while the signal is active.

Image after reset, Image after Home-Button:

Additional settings may be required for a visualization to be displayed by the device. For example, batches can only be displayed if they are sufficiently configured by the user.

Input simulation



NOTE!

The inputs and outputs adopt an undefined status. This parameter should only be activated for test purposes and also only if no digital outputs are connected.

7 Configuration

7.6 Analog inputs

The device is equipped with up to six optional analog inputs (three per optional module). These are universal analog inputs for connecting various measuring probes.

For example, the analog inputs are pooled into groups together with other analog signals via the "Groups" configuration and are available for further use via these groups.

Device dialog (excerpt)

The screenshot shows a configuration dialog for 'Analog input 1' at 10:15:22. The fields are as follows:

- Channel designation: AI01
- Channel description: Analog input 01
- Sensor: Resistance-Thermometer 2L
- Temperature input: (empty)
- Unit: °C
- Linearization: Pt100
- Resistance measuring range: (empty)
- Measuring range-Start: -200.00 °C
- Measuring range-End: +850.00 °C





Parameters

Parameters	Selection/settings	Description
Channel designation	AI0x Use default text or enter other text.	Name (short description) with max. 5 characters that is used along with the channel description in the visualizations.
Channel description	Analog input 0x Use default text or enter other text.	Description with max. 21 characters that is used along with the channel designation in the visualizations.
Sensor	Selection of measuring probe for the relevant analog input	
	Inactive	No sensor selected Deviating default setting for analog input 1 to 3 (see below)
	Res. thermometer 2L (2-wire)	RTD temperature probe in 2-wire circuit
	Res. thermometer 3L (3-wire)	RTD temperature probe in 3-wire circuit
	Res. thermometer 4L (4-wire)	RTD temperature probe in 4-wire circuit





7 Configuration

Parameters	Selection/settings	Description
	Resistance/potentiometer 2L (2-wire)	Resistance/potentiometer in 2-wire circuit
	Resistance/potentiometer 3L (3-wire)	Resistance/potentiometer in 3-wire circuit
	Resistance/potentiometer 4L (4-wire)	Resistance/potentiometer in 4-wire circuit
	Res.transmitter/WFG	Resistance transmitter
	Thermocouple	Thermocouple
	Voltage 0 to 70 mV	Voltage signal
	Voltage 0 to 1 V	Voltage signal
	Voltage -1 to +1 V	Voltage signal
	Voltage 0 to 10 V	Voltage signal
	Voltage -10 to +10 V	Voltage signal
	Current 0 to 20 mA	Current signal Default setting for analog input 1 to 3
	Current 4 to 20 mA	Current signal
Temperature input	In the case of a voltage/current signal, resistance/potentiometer, or resistance transmitter, the measured value must be defined as a temperature to convert automatically when changing the temperature unit.	
	No	Measured value is not a temperature.
	Yes	Measured value is a temperature.
Unit	Measured value unit for voltage/current signal, resistance/potentiometer or resistance transmitter	
	% (Max. 5 characters)	The unit is displayed if the measured value is displayed in numerical form
Linearization 	Available options and default settings depend on the measuring sensor selected.	
	Linear	
	Pt50	IEC 751: 2008
	Pt100	IEC 751: 2008
	Pt500	IEC 751: 2008
	Pt1000	IEC 751: 2008
	Pt100 JIS	JIS 1604
	Pt50 GOST	GOST 6651-2009 A.2
	Pt100 GOST	GOST 6651-2009 A.2
	Cu50	GOST 6651-2009 A.3
	Cu100	GOST 6651-2009 A.3
	Ni100	DIN 43760
	Ni100 GOST	GOST 6651-2009 A.5
	Fe-CuNi L	DIN 43710
	Fe-CuNi "J"	IEC 60584-1

7 Configuration

Parameters	Selection/settings	Description
	Cu_CuNi U Cu-CuNi T NiCr-Ni K NiCr-CuNi E NiCrSi-NiSi N Pt10Rh-Pt S Pt13Rh-Pt R Pt30Rh-Pt6Rh B W5Re-W26Re C W3Re-W25Re D W5Re-W20Re A1 Chromel-Copel L Chromel®-Alumel® Customer-specific 1 to 4	DIN 43710 IEC 60584-1 IEC 60584-1 IEC 60584-1 IEC 60584-1 IEC 60584-1 IEC 60584-1 IEC 60584-1 ASTM E230M-11 ASTM E1751M-09 GOST R 8.585-2001 GOST R 8.585-2001 GOST R 8.585-2001 Customer-specific linearization using grid points (pairs of values) or 4th order polynomial
Resistance measuring range	Measuring range for resistance/potentiometer and for customer-specific linearization with RTD temperature probe	
	0 to 4000 Ω 0 to 400 Ω	
Measuring range start 	-99999 to +99999 (Default setting depends on sensor and linearization.)	Lower limit of measuring range (for voltage/current signal, resistance/potentiometer, or resistance transmitter) If the measured value is below the lower limit, "<<<<<" (out of range) is shown for a numerical display.
Measuring range end 	-99999 to +99999 (Default setting depends on sensor and linearization.)	Upper limit of measuring range (for voltage/current signal, resistance/potentiometer or resistance potentiometer/resistance transmitter) If the measured value is above the upper limit, "<<<<<" (out of range) is shown for a numerical display.
Scaling start 	-99999 to +99999 (Default setting depends on sensor and linearization.)	Lower limit of measuring range or display range (depending on sensor and linearization)
Scale end 	-99999 to +99999 (Default setting depends on sensor and linearization.)	Upper limit of measuring range or display range (depending on sensor and linearization)

7 Configuration

Parameters	Selection/settings	Description
Comma format (decimal place)	Number of pre-decimal and decimal places for the numerical display of the measured value Even if the number of decimal places is fixed, the format is automatically changed if needed in order to display all digits before the decimal point.	
	Auto XXXXXp XXXXpX XXXpXX XXpXXX XpXXXX	Automatic No decimal place One decimal place Two decimal places Three decimal places Four decimal places
Offset 	-99999 to 0 to +99999	Correction value
Filter time constant 	0 s to 1 s to 100 s	Time constant for adjusting the digital input filter (0 s = filter off)
Compensation	Selection of cold junction (for thermocouple)	
	Internal Pt100 External constant	Internal Pt100 temperature probe Constant cold junction temperature
Ext. reference temperature	-30 to 0 to +85	Cold junction temperatures (for thermocouple and constant cold junction temperature)
Resistance Ra or Ro 	0 Ω to 4000 Ω	For Resistance transmitter: Resistance Ra between slider (S) and start (A), if the slider is positioned at the start. For Resistance/potentiometer: Offset resistance Ro
Resistance Rs or Rx 	0 Ω to 1000 Ω to 4000 Ω	For Resistance transmitter: Resistance range Rs of slider For Resistance/potentiometer: Shifting resistance range Rx
Resistance Re 	0 Ω to 4000 Ω	For Resistance transmitter: Resistance Re between slider (S) and end (E), if the slider is positioned at the end.
Probe break detection	For a "Thermocouple" type sensor, probe break detection can be disabled.	
	Yes No	Detection is active. Detection is inactive.

Linearization

Linearization must be selected to match the sensor (measuring probe).

The predefined linearizations can be supplemented with **customer-specific linearization**.

⇒ Chapter 9.9 "Customer-specific linearization", page 222

7 Configuration

Measuring range

For customer-specific linearization, the values are identical to the settings at that point for the "Measuring range start" and "Measuring range end;" they cannot be changed here.

Scaling

In typical linearizations for **RTD temperature probes and thermocouples**, this parameter delimits the measuring range.

Example: Pt100, scaling 0 to 200 °C The physical measuring range of the hardware from -200 to +850 °C is delimited. Only measured values in the range 0 to 200 °C are processed. The diagram and bar graph have a plottable range of 0 to 200 °C. The values are covered by automatic °C/°F conversion.

For **voltage and current signals** the measured value is scaled, taking the measuring range into account.

Example: Input 0 to 20 mA; measuring range start 5 mA; measuring range end 18 mA; scaling: -500 to +1000

Only values in the range 5 to 18 mA are considered for the measuring range 0 to 20 mA. The value range 5 to 18 mA is scaled to a range of -500 to +1000. 5 mA corresponds to -500, 18 mA to +1000. For the diagram, bar graph, and all downstream processing, the range of -500 to +1000 is used. The values are covered by automatic °C/°F conversion if the measured value is defined as a temperature (parameter "Temperature input").

For **customer-specific linearization** the values initially reflect the local settings for "Measuring range start" and "Measuring range end;" the scaling range can be further delimited here.

Offset

To offset plant-specific deviations, the measured value can be corrected (offset) for each analog input (following linearization). A positive or negative form of the correction value is added to the measured value (entering a negative correction value reduces the measured value). Typical applications include compensating for the lead wire resistance of a RTD temperature probe in a two-wire circuit.

Filter time constant

The filter time constant is used to adjust the digital input filter (2nd order filter). If the input signal changes suddenly, approx. 26 % of the change is recorded following a period that corresponds to the filter time constant (2 × filter time constants: approx. 59 %; 5 × filter time constants: approx. 96 %). A large filter time constant means: high attenuation of interference signals, slow reaction to the actual measured value display, low limit frequency (low-pass filter).

7 Configuration

Resistance Ra or Ro, Rs or Rx, Re

The overall resistance $R_a + R_s + R_e$ (or $R_o + R_x$) must not exceed 4000Ω .

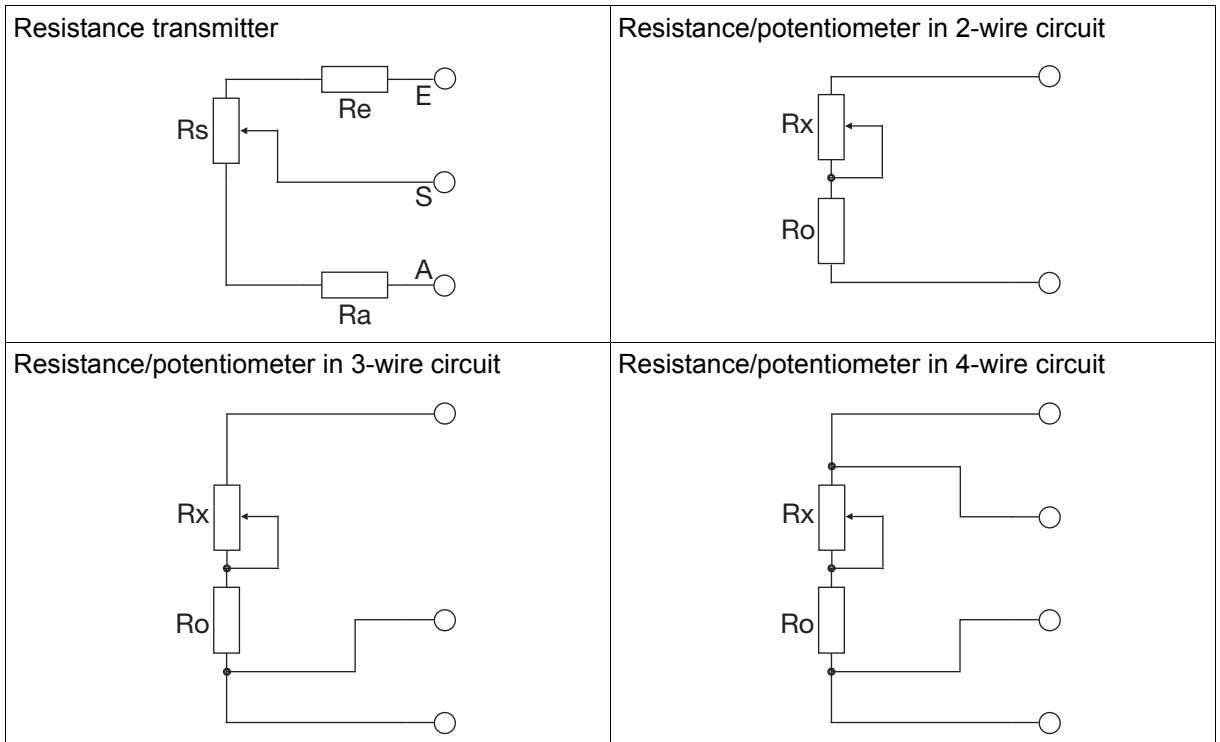

7 Configuration

7.6.1 Limit value monitoring

Limit value monitoring with one or two limit values (alarm 1, alarm 2) can be activated for each analog input. In out-of-limit cases, an alarm signal is activated. Depending on the configuration, an entry is made in the event list or additionally in the alarm list. In the latter case, the alarm/event text is displayed in the status bar (until another alarm occurs); the collective alarm is enabled, and the plotter trace may be displayed in a different color.

This limit value monitoring is independent of the up to 6 (or 24 as of device version 02) general limit value monitoring values (Configuration > Limit value monitoring) and available in addition to them.

Device dialog





The screenshot shows a configuration window titled 'Analog input 1' with a timestamp of 10:21:11. It features a list of settings for 'Alarm 1':

- Activation/Type: Maximum alarm
- Alarm/Event list: Alarm/Event
- Alarm-/Event list: Alarm 1 Analog input 01
- Limit value: +0.0000 °C
- Switching differential: +0.0000 °C
- Alarm suppression: No selection
- Alarm delay: 0 s

Below the settings is a section for 'Alarm 2' which is currently collapsed. At the bottom of the dialog are three icons: a close button (X), a help button (book icon), and a confirm button (checkmark).

Parameters

Parameters	Selection/settings	Description
Activation/Type 	Inactive Min. alarm Max. alarm	Limit value monitoring is inactive. Alarm signal is active if the value drops below the limit value. Alarm signal is active if the limit value is exceeded.
Alarm/Event list 	Inactive (signal only) Event Alarm/event	In out-of-limit cases, only the alarm signal is activated. The alarm/event text is entered in the event list. The alarm/event text is entered in the alarm list and the event list. The collective alarm is activated and the text of the last alarm to occur is displayed in the status bar.
Alarm/Event text	Use default text or enter other text.	Text entered in the alarm and event list and displayed in the status bar.

Parameters	Selection/settings	Description
Limit value 	-99999 to 0 to +99999	If the limit value is exceeded (max. alarm case) or the value drops below the limit (min. alarm case), an out-of-limit case exists.
Switching differential 	0 to 99999	The switching differential is used to suppress constant switching of the alarm signal in the event of minor fluctuations of the input signal around the limit value.
Alarm suppression 	No selection Digital selector	The selected digital signal (high-active) prevents the alarm signal being activated.
Alarm delay 	0 s to 999 s As of device version 02: 0 s to 32767 s	Delay time for alarm signal activation

Activation/type, limit value, switching differential

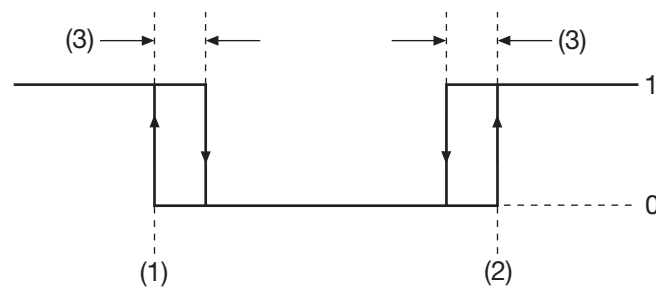

- (1) Limit value for min. alarm
- (2) Limit value for max. alarm
- (3) Switching differential

- 1 Alarm signal on
- 0 Alarm signal off

Alarm/Event list

All events and their time of occurrence are added to the event list. If the event is an alarm, newly occurring alarms and their time of occurrence are additionally added to the alarm list. If an alarm is made inactive, it is removed from the alarm list and the time of removal is added to the event list.

Alarm suppression, alarm delay

Alarm suppression and alarm delay prevent or delay entries being added to the event list and alarm list, activation of the collective alarm, displaying in the status bar, and the color change (analog value, plotter trace).

Alarm delay

During an out-of-limit case, the alarm signal is only activated after the delay time has expired. If the limit value infringement no longer exists at that point, the time for the next limit value infringement restarts from zero.

7 Configuration

Behavior in the event of fault

If the input signal returns an error value, the alarm signal is activated as long as limit value monitoring is enabled. For this to happen, a min. or max. alarm must be configured (the limit value is unimportant here). Alarm suppression is also taken into consideration in this case, but not the alarm delay.

7.7 Analog outputs

The device is equipped with two optional analog inputs (one per optional module). Each analog output can be configured as a current or voltage output (current signal, voltage signal) and is freely scaleable.

Device dialog



Analog output 1		🔒 10:24:35
Channel designation	AA01	
Channel description	Analog output 01	
Signal source	Analog input 1	
Output signal	Voltage 0-10 V	
Scale start	+0.0000 °C	
Scale end	+100.00 °C	
Behaviour in the event of fault	Replacement value	
Replacement value	+0.0000 V	

✕
📄
✓

Parameters

Parameters	Selection/settings	Description
Channel designation	AO0x Use default text or enter other text.	Name (short description) with max. 5 characters that is used along with the channel description in the visualizations.
Channel description	Analog output 0x Use default text or enter other text.	Description with max. 21 characters that is used along with the channel designation in the visualizations.
Signal source	Analog selector No selection	Analog signal that is issued via the analog output. In the event of "No selection" a voltage of 0 V is output.
Output signal	Physical output signal	
	Voltage 0 to 10 V	Voltage signal
	Current 0 to 20 mA	Current signal
	Current 4 to 20 mA	Current signal
	Voltage 10 to 0 V	Voltage signal, inverted
	Current 20 to 0 mA	Current signal, inverted
Current 20 to 4 mA	Current signal, inverted	
Scaling start	-99999 to 0 to +99999	Start value of value range

7 Configuration

Parameters	Selection/settings	Description
Scale end 	-99999 to 100 to +99999	End value of value range
Behavior in the event of fault 	Value of the output signal after deviation above or below the measuring range (out of range = o-o-r) The selection options "Defined low value" and "Defined high value" are only available for the output signals 4 to 20 mA and 20 to 4 mA.	
	Replacement value	Configurable value (parameter "Replacement value")
	Defined low value	Value for deviation below measured value/short-circuit according to NAMUR recommendation
	Defined high value	Value for deviation above measured value/probe break according to NAMUR recommendation
Replacement value	0 to 22 mA or 0 to 10 V (depending on output signal)	Value of the output signal in the event of deviation above or below the measuring range

Scaling start, scaling end

A value range is assigned to the physical output signal by specifying the zero point and end value (scaling). The default setting corresponds to a value range of 0 to 100%.

If, for example, a temperature with a value range from 150 °C to 500 °C is issued via an analog output with signal type 0 to 20 mA, the zero point is set to 150 (corresponding to 0 mA) and the end value is set to 500 (corresponding to 20 mA).

Behavior in the event of fault

Output value in the event of fault:

Signal type (parameter "Output signal")	Output value
Voltage 0 to 10 V	Replacement value (configurable)
Current 0 to 20 mA	Replacement value (configurable)
Current 4 to 20 mA	Replacement value (configurable) or Defined low value (1 mA) or Defined high value (22 mA)
Voltage 10 to 0 V	Replacement value (configurable)
Current 20 to 0 mA	Replacement value (configurable)
Current 20 to 4 mA	Replacement value (configurable) or Defined low value (1 mA) or Defined high value (22 mA)

This behavior also applies for probe/wire break or probe/conductor short-circuit. Error detection depends on the type of measuring probe (see technical data, measuring circuit monitoring).

⇒ Chapter 11.1.1 "Analog inputs (options 1 and 2)", page 259

7 Configuration

Limits acc. to NAMUR recommendation NE 43 for signal type 4 to 20 mA:

Measurement information M	3.8 to 20.5 mA
Failure information A for deviation below measured value/short-circuit ("NAMUR Low")	≤ 3.6 mA
Failure information A for deviation above measured value/probe break ("NAMUR High")	≥ 21 mA

Behavior after power on

During the initialization phase of the device, the output signal assumes a value of 0 V or 0 mA depending on the configuration of the relevant analog output.

7 Configuration

7.8 Digital inputs

The device is equipped with up to 12 optional digital inputs (six per optional module). The inputs are actuated with an external voltage DC 0/24 V or via a zero-potential contact (auxiliary voltage in place).

The digital inputs are pooled into groups along with other digital signals in the "Groups" configuration and are then available for further use via these groups.

Device dialog

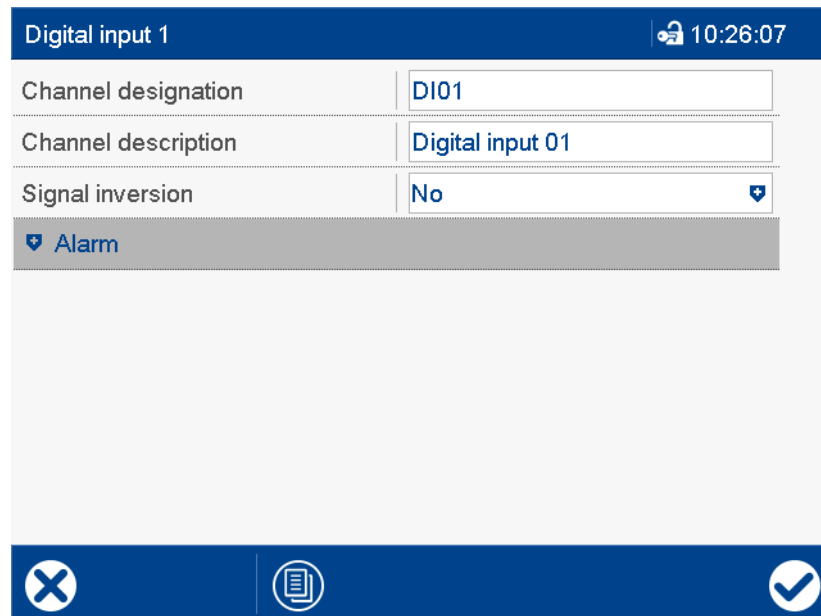

Parameters

Parameters	Selection/settings	Description
Channel designation	DIxx Use default text or enter other text.	Name (short description) with max. 5 characters that is used along with the channel description in the visualizations.
Channel description	Digital input xx Use default text or enter other text.	Description with max. 21 characters that is used along with the channel designation in the visualizations.
Signal inversion	Inversion of the input signal	
	No	The signal is not inverted.
	Yes	The signal is inverted.

7.8.1 Signal monitoring

Signal monitoring (alarm) can be activated for each digital input.

In alarm cases, an alarm signal is activated. Depending on the configuration, an entry is made in the event list or additionally in the alarm list. In the latter case, the alarm/event text is displayed in the status bar (until another alarm occurs); the collective alarm is enabled, and the plotter trace may be displayed in a different color.

Device dialog

Digital input 1
🔒 10:29:36

Channel designation	DI01	▲
Channel description	Digital input 01	
Signal inversion	No	+
🏠 Alarm		
Activation	Active	▼
Alarm/Event list	Inactive (Signal only)	▼
Alarm at level	High(1)	▼
Alarm/Event text	Alarm Digital input 01	
Alarm delay	0 s	▼

✕
📄
☑

Parameters

Parameters	Selection/settings	Description
Activation	Inactive Active	Signal monitoring is inactive. Signal monitoring is active.
Alarm/Event list 	Inactive (signal only) Event Alarm/event	In the event of an alarm, only the alarm signal is activated. The alarm/event text is entered in the event list. The alarm/event text is entered in the alarm list and the event list. The collective alarm is activated and the text of the last alarm to occur is displayed in the status bar.
Alarm active at	High (1) Low (0)	Alarm at high level (1) Alarm at low level (0)
Alarm/Event text	Use default text or enter other text.	Text entered in the alarm and event list and displayed in the status bar.
Alarm delay 	0 s to 999 s As of device version 02: 0 s to 32767 s	Delay time for alarm signal activation
Alarm suppression 	Digital selector No selection	The selected digital signal (high-active) prevents the alarm signal being activated.

Alarm/Event list

All events and their time of occurrence are added to the event list. If the event is an alarm, newly occurring alarms and their time of occurrence are additionally added to the alarm list. If an

7 Configuration

alarm is made inactive, it is removed from the alarm list and the time of removal is added to the event list.

Alarm delay

In the event of an alarm (parameter "Alarm active at"), the alarm signal is not activated until the delay time has expired. If the alarm case is left in the meantime, the timer restarts when a new alarm case occurs.

Alarm delay, alarm suppression

Alarm delay and alarm suppression delay or prevent entries being added to the event list and alarm list, activation of the collective alarm, and display in the status bar.

7.9 Digital inputs/outputs

The device is equipped with up to 12 optional individually switchable digital inputs/outputs (optional module). The inputs are actuated with an external voltage DC 0/24 V or via a zero-potential contact (auxiliary voltage in place). The outputs deliver an output signal DC 0/24 V. Digital input 1 can be used as a counter input up to 12.5 kHz (counts each positive edge).

Device dialog

Digital input/output 1		10:31:48
Function	Input	
Channel designation	DIO01	
Channel description	Digital inp./outp. 01	
Signal source		
Signal inversion	No	
Alarm		

Parameters

Parameters	Selection/settings	Description
Function	Input Output	Digital input Digital output
Channel designation	DIOxx Use default text or enter other text.	Name (short description) with max. 5 characters that is used along with the channel description in the visualizations.
Channel description	Digital input/output xx Use default text or enter other text.	Description with max. 21 characters that is used along with the channel designation in the visualizations.
Signal source (for output only)	Digital selector No selection	Digital signal output via the digital output. "No selection": the output signal corresponds to the "Low" state (0 V for non-inverted signals, 24 V for inverted signals).
Signal inversion	Inversion of the input or output signal	
	No Yes	The signal is not inverted. The signal is inverted.

7 Configuration

Behavior after power on

During the device's initialization phase, all connections are actuated as digital inputs, even if they were previously configured as digital outputs.



7.9.1 Signal monitoring

Signal monitoring (alarm) can be activated for each digital input/output.

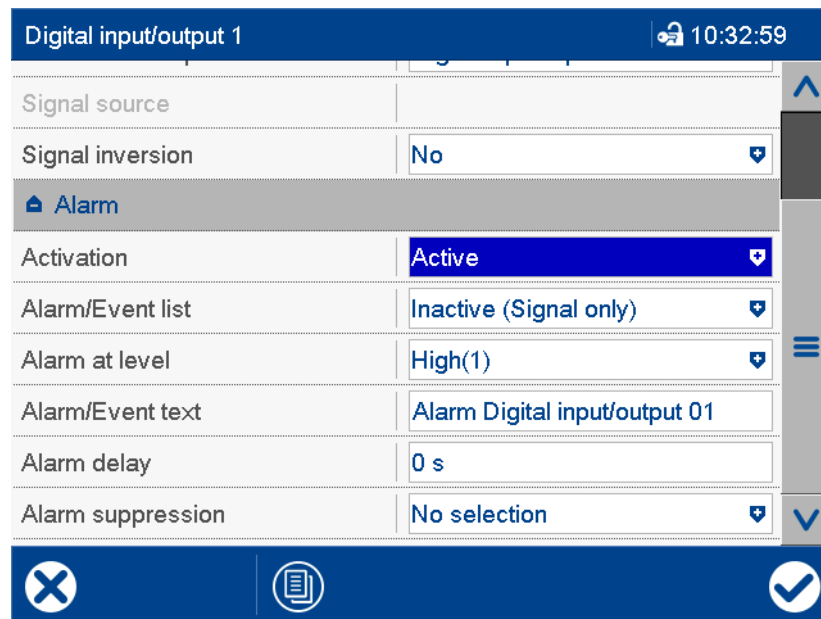
Device dialog



Parameters

Parameters	Selection/settings	Description
Activation	Inactive Active	Signal monitoring is inactive. Signal monitoring is active.
Alarm/Event list 	Inactive (signal only) Event Alarm/event	In the event of an alarm, only the alarm signal is activated. The alarm/event text is entered in the event list. The alarm/event text is entered in the alarm list and the event list. The collective alarm is activated and the text of the last alarm to occur is displayed in the status bar.
Alarm active at	High (1) Low (0)	Alarm at high level (1) Alarm at low level (0)
Alarm/Event text	Use default text or enter other text.	Text entered in the alarm and event list and displayed in the status bar.
Alarm delay 	0 s to 999 s As of device version 02: 0 s to 32767 s	Delay time for alarm signal activation

7 Configuration

Parameters	Selection/settings	Description
Alarm suppression 	Digital selector No selection	The selected digital signal (high-active) prevents the alarm signal being activated.

Alarm/Event list

All events and their time of occurrence are added to the event list. If the event is an alarm, newly occurring alarms and their time of occurrence are additionally added to the alarm list. If an alarm is made inactive, it is removed from the alarm list and the time of removal is added to the event list.

Alarm delay

In the event of an alarm (parameter "Alarm active at"), the alarm signal is not activated until the delay time has expired. If the alarm case is left in the meantime, the timer restarts when a new alarm case occurs.

Alarm delay, alarm suppression

Alarm delay and alarm suppression delay or prevent entries being added to the event list and alarm list, activation of the collective alarm, and display in the status bar.

7 Configuration

7.10 Relay

The device is equipped with a relay output (changeover contact).

Device dialog

Relay		10:49:58
Signal source	Digital input 1	
Channel designation	REL01	
Channel description	Relay output 01	
Signal inversion	No	

Parameters

Parameters	Selection/settings	Description
Signal source	Digital selector No selection	Digital signal for controlling the relay "No selection" means that the relay is in idle state.
Channel designation	REL01 Use default text or enter other text.	Name (short description) with max. 5 characters that is used along with the channel description in the visualizations.
Channel description	Relay output 01 Use default text or enter other text.	Description with max. 21 characters that is used along with the channel designation in the visualizations.
Signal inversion	Inversion of the digital signals for controlling the relay	
	No	The signal is not inverted.
	Yes	The signal is inverted.

Behavior after power on

During the initialization phase of the device, the relay is in idle state.

7.11 External analog inputs

The device is equipped with 24 external analog inputs. These are analog signals that are transferred to the device via Modbus from external systems. As of device version 02 the external analog inputs can also be written by a barcode scanner (see Chapter 11.4.2 "Enter event texts and process values", page 271).

The external analog inputs are pooled into groups along with other analog signals via the "Groups" configuration and are then available for further use via these groups.

Device dialog

External analog input 1		🔒 10:51:45
Channel designation	eAI01	↑
Channel description	Ext. Analog input 01	
Temperature	None	↓
Unit	%	
Comma format	XXXXpX	↓
Start display range	+0.0000 %	
End display range	+100.00 %	
Reset signal	No selection	↓
Saving	No	↓

Navigation icons: Close (X), Print (📄), Confirm (✓)

Parameters

Parameters	Selection/settings	Description
Channel designation	eAIxx Use default text or enter other text.	Name (short description) with max. 5 characters that is used along with the channel description in the visualizations.
Channel description	Ext. analog input xx Use default text or enter other text.	Description with max. 21 characters that is used along with the channel designation in the visualizations.
Temperature	The parameter determines whether the transferred value (measured value) is evaluated as a temperature value, a temperature difference, or not as a temperature. The distinction between temperature value and temperature difference is significant for conversion from °C to °F.	
	None	The value is not a temperature.
	Temperature difference	The value is a temperature difference.
Unit	% (Max. 5 characters)	The unit is displayed if the measured value is displayed in numerical form.

7 Configuration

Parameters	Selection/settings	Description
Comma format (decimal place)	Number of pre-decimal and decimal places for the numerical display of the input value Even if the number of decimal places is fixed, the format is automatically changed if needed in order to display all digits before the decimal point.	
	Auto XXXXXp XXXXpX XXXpXX XXpXXX XpXXXX	Automatic No decimal place One decimal place Two decimal places Three decimal places Four decimal places
Start of display range	-99999 to 0 to +99999	Lower limit of display range
Display range end	-99999 to 100 to +99999	Upper limit of display range
Reset signal 	Digital selector No selection	The reset signal (high active) sets the analog input to a status of "no input signal".
Saving	No Yes	If "Yes", the current value is saved upon switch-off (power off) and is available again upon switch-on (power on).

Reset signal

The device can monitor the connection to the Modbus master as a Modbus slave. If the connection is down (timeout from the master), a digital signal is activated (slave timeout ...). This signal can be used as a reset signal to set the input to a defined value.

Using the device (slave) to monitor the Modbus connection only makes sense if the external master writes to the input. If the external master only has read access to the input, this function has no meaning.

7.11.1 Limit value monitoring

Limit value monitoring with one or two limit values (alarm 1, alarm 2) can be activated for each external analog input. In out-of-limit cases, an alarm signal is activated. Depending on the configuration, an entry is made in the event list or additionally in the alarm list. In the latter case, the alarm/event text is displayed in the status bar (until another alarm occurs); the collective alarm is enabled, and the plotter trace may be displayed in a different color.

This limit value monitoring is independent of the up to 6 (or 24 as of device version 02) general limit value monitoring values (Configuration > Limit value monitoring) and available in addition to them.

Device dialog





The screenshot shows a configuration window titled 'External analog input 1' with a timestamp of 10:52:56. It displays settings for 'Alarm 1' and 'Alarm 2'. The 'Alarm 1' settings are as follows:

Parameter	Value
Activation/Type	Maximum alarm
Alarm/Event list	Inactive (Signal only)
Alarm/Event text	Alarm1 ext. analog input 01
Limit value	+0.0000 %
Switching differential	+0.0000 %
Alarm suppression	No selection
Alarm delay	0 s

Parameters

Parameters	Selection/settings	Description
Activation/Type 	Inactive Min. alarm Max. alarm	Limit value monitoring is inactive. Alarm signal is active if the value drops below the limit value. Alarm signal is active if the limit value is exceeded.
Alarm/Event list 	Inactive (signal only) Event Alarm/event	In out-of-limit cases, only the alarm signal is activated. The alarm/event text is entered in the event list. The alarm/event text is entered in the alarm list and the event list. The collective alarm is activated and the text of the last alarm to occur is displayed in the status bar.
Alarm/Event text	Use default text or enter other text.	Text entered in the alarm and event list and displayed in the status bar.

7 Configuration

Parameters	Selection/settings	Description
Limit value 	-99999 to 0 to +99999	If the limit value is exceeded (max. alarm case) or the value drops below the limit (min. alarm case), an out-of-limit case exists.
Switching differential 	0 to 99999	The switching differential is used to suppress constant switching of the alarm signal in the event of minor fluctuations of the input signal around the limit value.
Alarm suppression 	Digital selector No selection	The selected digital signal (high-active) prevents the alarm signal being activated.
Alarm delay 	0 s to 999 s As of device version 02: 0 s to 32767 s	Delay time for alarm signal activation

Activation/type, limit value, switching differential

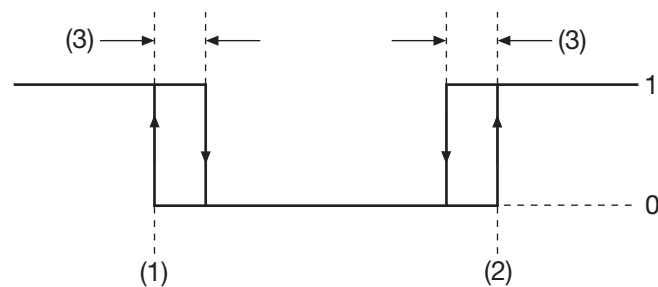

- (1) Limit value for min. alarm
- (2) Limit value for max. alarm
- (3) Switching differential
- 1 Alarm signal on
- 0 Alarm signal off

Alarm/Event list

All events and their time of occurrence are added to the event list. If the event is an alarm, newly occurring alarms and their time of occurrence are additionally added to the alarm list. If an alarm is made inactive, it is removed from the alarm list and the time of removal is added to the event list.

Alarm suppression, alarm delay

Alarm suppression and alarm delay prevent or delay entries being added to the event list and alarm list, activation of the collective alarm, the display in the status bar, and the color change (analog value, plotter trace).

Alarm delay

During an out-of-limit case, the alarm signal is only activated after the delay time has expired. If the limit value infringement no longer exists at that point, the time for the next limit value infringement restarts from zero.

Behavior in the event of fault

If the input signal returns an error value, the alarm signal is activated as long as limit value monitoring is enabled. For this to happen, a min. or max. alarm must be configured (the limit value is unimportant here). Alarm suppression is also taken into consideration in this case, but not the alarm delay.

7 Configuration

7.12 External digital inputs

The device is equipped with 24 external digital inputs. These are digital signals that are transferred to the device via Modbus from external systems. As of device version 02 the external digital inputs can also be written by a barcode scanner (see Chapter 11.4.2 "Enter event texts and process values", page 271).

The external digital inputs are pooled into groups along with other digital signals in the "Groups" configuration and are then available for further use via these groups.

Device dialog

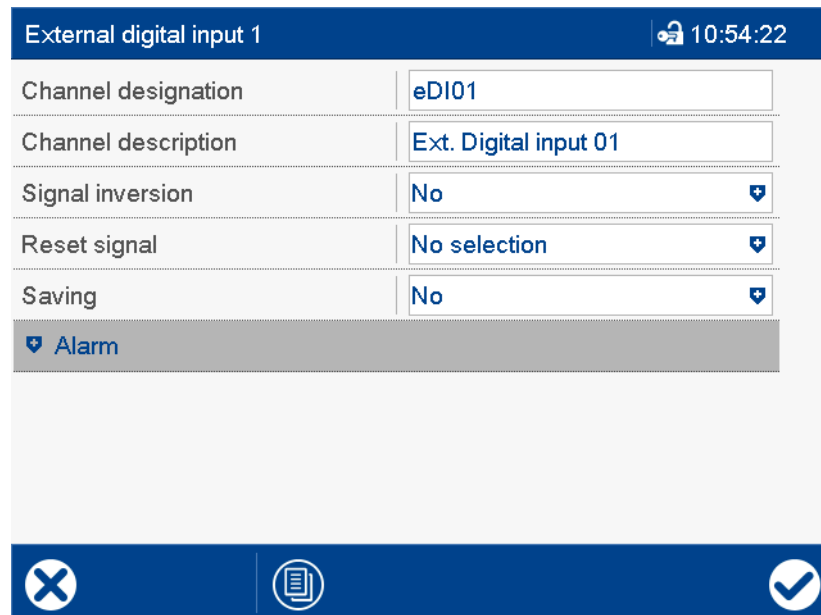

External digital input 1		🔒 10:54:22
Channel designation	eDI01	
Channel description	Ext. Digital input 01	
Signal inversion	No	
Reset signal	No selection	
Saving	No	
🔻 Alarm		
<div style="display: flex; justify-content: space-between; align-items: center;"> ✕ 📄 ✔ </div>		

Parameters

Parameters	Selection/settings	Description
Channel designation	eDIxx Use default text or enter other text.	Name (short description) with max. 5 characters that is used along with the channel description in the visualizations.
Channel description	Ext. digital input xx Use default text or enter other text.	Description with max. 21 characters that is used along with the channel designation in the visualizations.
Signal inversion	Inversion of the input signal No Yes	The signal is not inverted. The signal is inverted.
Reset signal 	Digital selector No selection	The reset signal (high active) sets the digital input to a binary value of 0.
Saving	No Yes	If "Yes", the current value is saved upon switch-off (power off) and is available again upon switch-on (power on).

Reset signal

The device can monitor the connection to the Modbus master as a Modbus slave. If the connection is down (timeout from the master), a digital signal is activated (slave timeout ...). This signal can be used as a reset signal to set the input to a defined value.

Using the device (slave) to monitor the Modbus connection only makes sense if the external master writes to the input. If the external master only has read access to the input, this function has no meaning.

7.12.1 Signal monitoring

Signal monitoring (alarm) can be activated for each external digital input.



Device dialog

External digital input 1		🕒 10:55:42
Reset signal	No selection	⬆
Saving	No	⬆
🏠 Alarm		
Activation	Active	⬆
Alarm/Event list	Inactive (Signal only)	⬆
Alarm at level	High (1)	⬆
Alarm/Event text	Alarm ext. digital input 01	
Alarm delay	0 s	
Alarm suppression	No selection	⬆

Parameters

Parameters	Selection/settings	Description
Activation	Inactive Active	Signal monitoring is inactive. Signal monitoring is active.
Alarm/Event list 📖	Inactive (signal only) Event Alarm/event	In the event of an alarm, only the alarm signal is activated. The alarm/event text is entered in the event list. The alarm/event text is entered in the alarm list and the event list. The collective alarm is activated and the text of the last alarm to occur is displayed in the status bar.
Alarm active at	High (1) Low (0)	Alarm at high level (1) Alarm at low level (0)

7 Configuration

Parameters	Selection/settings	Description
Alarm/Event text	Use default text or enter other text.	Text entered in the alarm and event list and displayed in the status bar.
Alarm delay 	0 s to 999 s As of device version 02: 0 s to 32767 s	Delay time for alarm signal activation
Alarm suppression 	Digital selector No selection	The selected digital signal (high-active) prevents the alarm signal being activated.

Alarm/Event list

All events and their time of occurrence are added to the event list. If the event is an alarm, newly occurring alarms and their time of occurrence are additionally added to the alarm list. If an alarm is made inactive, it is removed from the alarm list and the time of removal is added to the event list.

Alarm delay

In the event of an alarm (parameter "Alarm active at"), the alarm signal is not activated until the delay time has expired. If the alarm case is left in the meantime, the timer restarts when a new alarm case occurs.

Alarm delay, alarm suppression

Alarm delay and alarm suppression delay or prevent entries being added to the event list and alarm list, activation of the collective alarm, and display in the status bar.

7.13 External text variables

The device can receive 10 external texts (text variables 1 to 10, short or long) via Modbus; the texts are used for batch reporting. As of device version 02 the external text variables can also be written by a barcode scanner (see Chapter 11.4.2 "Enter event texts and process values", page 271).

Device dialog

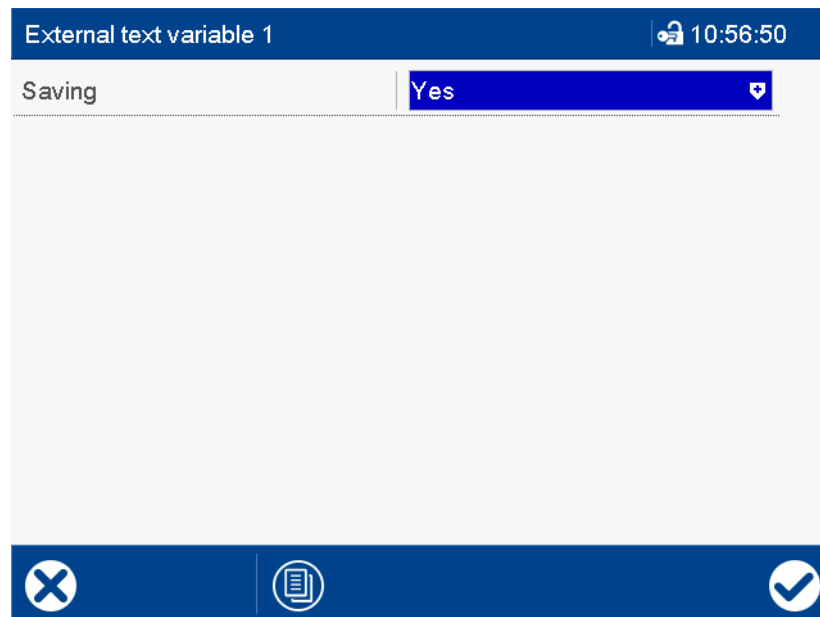

Parameters

Parameters	Selection/settings	Description
Saving	No Yes	If "Yes", the current text is saved upon switch-off (power off) and is available again upon switch-on (power on).



NOTE!

In addition to the ten texts for batch reporting, four additional texts can be transferred to the device via Modbus; they are used as event texts (one text per group).



NOTE!

As of device version 02 the external text variables and the external event texts can additionally be transferred as a long text. For this purpose separate Modbus addresses are available. As a result, applications based on device version 01 that have used the previous short texts can also be used with device version 02. If both Modbus addresses of a variable are used then the value of the variable will be overwritten. The user has to make sure that a variable is not overwritten unintentionally.

7 Configuration

7.14 Limit value monitoring

The device has 6 or 24 (as of device version 02) general limit value monitoring functions with one limit value each. Each limit value monitoring function delivers a status signal and an alarm signal:

- The status signal is active (1), if a max. alarm or a min. alarm was enabled and the limit value is exceeded or the value drops below the minimum (limit value infringement).
- The alarm signal depends on the status signal and the "Alarm for status" parameter.

Depending on the configuration, an entry is made in the event list or additionally in the alarm list. In the latter case, the alarm/event text is displayed in the status bar (until another alarm occurs); the collective alarm is enabled, and the plotter trace may be displayed in a different color.

General limit value monitoring is independent of limit value monitoring of the analog inputs and external analog inputs.

Device dialog

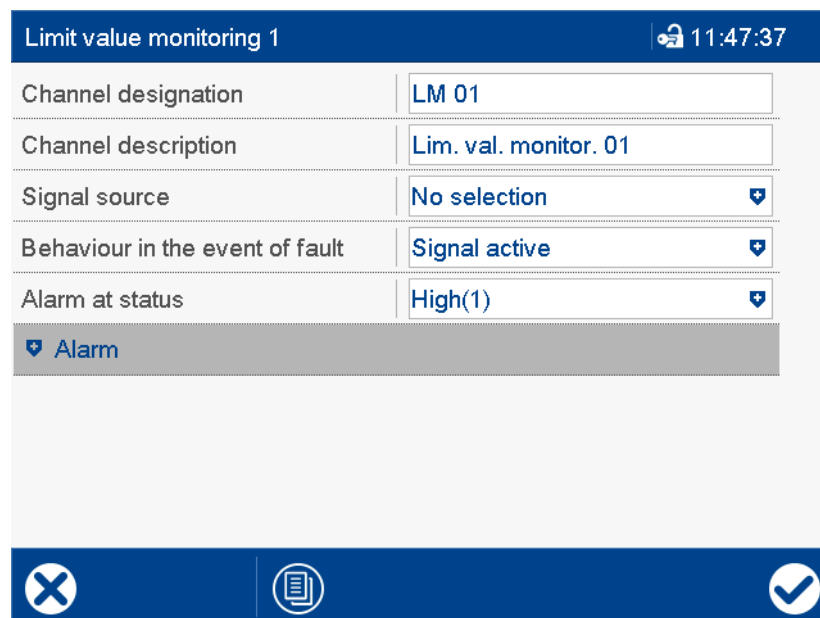

Parameters

Parameters	Selection/settings	Description
Channel designation	LM 0x Use default text or enter other text.	Name (short description) with max. 5 characters that is used along with the channel description in the visualizations.
Channel description	Limit value monitoring 0x Use default text or enter other text.	Description with max. 21 characters that is used along with the channel designation in the visualizations.

Parameters	Selection/settings	Description
Alarm for status	This setting decides whether the alarm signal is active for active or inactive limit value infringement.	
	High (1)	Alarm signal is active for a high level of the status signal (limit value infringement).
	Low (0)	Alarm signal is active for a low level of the status signal (no limit value infringement).
Signal source	Analog selector No selection	Input signal of limit value monitoring (signal to monitor).
Behavior in the event of fault	Behavior of the status signal if the input signal delivers an error value.	
	Signal inactive	Status signal is inactive.
	Signal active	Status signal is active.
	Signal unchanged	Status signal keeps the state it had before the fault.

7.14.1 Alarm

Device dialog

Limit value monitoring 1 11:48:53

Alarm at status High(1)

Alarm

Activation/Type Maximum alarm

Alarm/Event list Inactive (Signal only)

Alarm/Event text Alarm limit value monitoring 01

Limit value +0.0000

Switching differential +0.0000





Alarm suppression No selection

Alarm delay 0 s

Parameters

Parameters	Selection/settings	Description
Activation/Type 	Inactive	Limit value monitoring is inactive.
	Min. alarm	Status signal is active if the value drops below the limit value.
	Max. alarm	Status signal is active if the limit value is exceeded.

7 Configuration

Parameters	Selection/settings	Description
Alarm/Event list 	Inactive (signal only) Event Alarm/event	In out-of-limit cases, only the status signal is activated. The alarm/event text is entered in the event list. The alarm/event text is entered in the alarm list and the event list. The collective alarm is activated and the text of the last alarm to occur is displayed in the status bar.
Alarm/Event text	Use default text or enter other text.	Text entered in the alarm and event list and displayed in the status bar.
Limit value 	-99999 to 0 to +99999	If the limit value is exceeded (max. alarm case) or the value drops below the limit (min. alarm case), an out-of-limit case exists.
Switching differential 	0 to 99999	The switching differential is used to suppress constant switching of the status signal in the event of minor fluctuations of the input signal around the limit value.
Alarm suppression 	Digital selector No selection	The selected digital signal (high-active) prevents the status signal being activated.
Alarm delay 	0 s to 999 s As of device version 02: 0 s to 32767 s	Delay time for status signal activation

Activation/type, limit value, switching differential

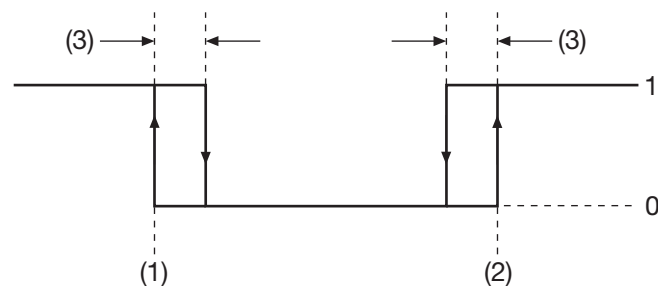

- (1) Limit value for min. alarm
- (2) Limit value for max. alarm
- (3) Switching differential
- 1 Status signal on
- 0 Status signal off

Alarm/Event list

All events and their time of occurrence are added to the event list. If the event is an alarm, newly occurring alarms and their time of occurrence are additionally added to the alarm list. If an alarm is made inactive, it is removed from the alarm list and the time of removal is added to the event list.

Alarm suppression, alarm delay

Alarm delay and alarm suppression delay or prevent entries being added to the event list and alarm list, activation of the collective alarm, and display in the status bar.

Alarm delay

During an out-of-limit case, the status signal is only activated after the delay time has expired. If the limit value infringement no longer exists at that point, the time for the next limit value infringement restarts from zero.

7 Configuration

7.15 Counters/Integrators

The device has six counters/integrators that act as counters, integrators, operating hours counters, high-speed counters, or can be used for configuring the total flow (volume):

- Counters are used to count digital signals.
- Integrators are used to integrate analog inputs.
- Operating time counters are used to measure the length of time that digital signals have been active.
- A high-speed counter can be used to record counter pulses up to 12.5 kHz (via optional digital input/output 1).
- The total flow is determined by integrating the volume flow (see Chapter 7.16 "Flow", page 144).

Stored counter and integrator statuses can be evaluated with the PCA3000 evaluation software on the PC.

7.15.1 General settings

Device dialog

Parameter	Value
Synchronization time	00:00:00
Start daily	00:00:00
End daily	00:00:00
Period	3 min
Weekday	Monday
Reset signal	Digital input 7
Integrator behaviour on fault	Stop calculation

Parameters

Parameters	Selection/settings	Description
Synchronization time 	00:00:00 to 23:59:59	Synchronization time for completion and restart of counters or integrators for which the "Type" parameter is configured as "Periodical", "Daily", or "Weekly".
Daily start	00:00:00 to 23:59:59	Start time of counters or integrators whose "Type" parameters are configured as "Daily from/to".

7 Configuration

Parameters	Selection/settings	Description
Daily end	00:00:00 to 23:59:59	End time of counters or integrators whose "Type" parameters are configured as "Daily from/to".
Period	1 min, 2 min, 3 min , 4 min, 5 min, 10 min, 15 min, 30 min, 1 h, 2 h, 3 h, 4 h, 6 h, 8 h, 12 h	Pulse period of counters or integrators for which the "Type" parameter is configured as "Periodical".
Weekday	Sunday, Monday , Tuesday, Wednesday, Thursday, Friday, Saturday	Weekday on which the counters and integrators for which the "Type" parameter is configured as "Weekly" are saved at the synchronization time and restarted with the start value 0.
Integrator behavior on fault	Behavior in the event of fault when integrating a measured value or determining the total flow	
	Stop calculation	Calculation is interrupted while the fault exists.
	Reject calculation	The calculation results are discarded.
Reset signal 	Digital selector No selection	The reset signal is used to set the counter and integrator statuses to 0 (independent of other parameters).

Synchronization time

The synchronization time is used for completion and restart for daily, weekly, and periodical counters and integrators. When the synchronization time is reached, all statuses are saved and the function with the start value 0 is restarted. With the weekly type, the "Weekday" parameter also plays a role.

The synchronization time will be explained in more detail below, using the example of a periodical counter. The closure and restart is performed at the next point in time occurring in the time grid – depending on synchronization time and period.

Example:

Period = 2 hours

Synchronization time = 11:30:00

Power on = 09:11:00 1st period from 09:11 to 09:30 = 19 minutes

2nd period from 09:30 to 11:30 = 2 hours

3rd period from 11:30 to 13:30 = 2 hours

etc.

Reset signal

The current statuses are not saved when the counters and integrator statuses are reset. This function can be used when setting up a plant (test run) or as a so-called "Clear switch", for example.



NOTE!



The general reset signal can be overwritten for each counter/integrator using an individual reset signal. See Chapter 7.15.2 "Specific settings", page 136.

7 Configuration

7.15.2 Specific settings

Device dialog (excerpt) – counter/integrator 1 ... 6

Counter/Integrator 1		11:53:21
Function	Counter	▲
Save (for analysis)	Yes	▼
Type	Daily	▼
External control signal		☰
Additional saving	Inactive	▼
Signal source	No selection	▼
Factor	+1000.0	
Time base		
Threshold		▼

Parameters

Parameters	Selection/settings	Description
Function	Operating mode of the counter/integrator	
	Inactive	Counter/integrator is switched off.
	Counters	Counter for the pulses of a digital signal
	Integrator	Integration of an analog signal
	Flow (total)	Integration of volume flow (determining the total flow)
	Operating time	Determination of the length of time that a digital signal is active.
Save (for analysis)	High-speed counter	Counter for the pulses of a digital signal up to 12.5 kHz; only available if a digital I/O card is in place (option).
	The result (status of the counter/integrator) can be saved in order to evaluate it with the PCA3000 evaluation software.	
	No	Event is not saved.
	Yes	Event is saved.

7 Configuration

Parameters	Selection/settings	Description
Type 	<p>This setting decides when the current status of the counter/integrator is saved. Depending on the specific setting (Yes - No), the parameters from Chapter 7.15.1 "General settings", page 134 must also be taken into consideration.</p> <p>Periodically</p> <p>External</p> <p>Daily</p> <p>Weekly</p> <p>Monthly</p> <p>Yearly (annual)</p> <p>Total</p> <p>Daily from/to</p>	<p>Completion and restart will be determined by the "Period" and "Synch. time" parameters.</p> <p>Completion and restart will be determined by an external control signal. The counter/integrator functions when the signal is set (High).</p> <p>The counter/integrator is counted/integrated for a day (24 hours). Completion and restart will be determined by the "Synch. time" parameter.</p> <p>The counter/integrator is counted/integrated for a week. Completion and restart will be determined by the "Week-day" and "Synch time" parameters.</p> <p>The counter/integrator is counted/integrated for a month. Completion and restart are performed on the first day of the month at 00:00.</p> <p>The counter/integrator is counted/integrated for a year. Completion and restart are performed on the first day of the year at 00:00.</p> <p>The counter/integrator is counted/integrated for the entire duration of the current configuration.</p> <p>The counter/integrator is counted/integrated for a period within one day. Restart and completion are determined by the "Daily start" and "Daily end" parameters.</p>
External control signal	Digital selector No selection	External control signal (high active) for completion and restart of the counter/integrator (for the "External" type). The counter/integrator functions when the signal is active.

7 Configuration

Parameters	Selection/settings	Description
Additional saving 	<p>This parameter decides whether additional storage of the current statuses is to take place (in addition to the save operation resulting from the "Type" parameter). The current statuses are saved but not reset. Depending on the specific setting (Yes - No), the parameters from Chapter 7.15.1 "General settings", page 134 must also be taken into consideration.</p> <p>The parameter is only active for "Save (for evaluation)" = Yes.</p>	
	<p>Inactive</p> <p>Periodically</p> <p>Daily</p> <p>Weekly</p> <p>Monthly</p> <p>Yearly (annual)</p>	<p>No additional storage</p> <p>Completion and restart will be determined by the "Period" and "Synch. time" parameters.</p> <p>The counter/integrator is counted/integrated for a day (24 hours). Completion and restart will be determined by the "Synch. time" parameter.</p> <p>The counter/integrator is counted/integrated for a week. Completion and restart will be determined by the "Week-day" and "Synch time" parameters.</p> <p>The counter/integrator is counted/integrated for a month. Completion and restart are performed on the first day of the month at 00:00.</p> <p>The counter/integrator is counted/integrated for a year. Completion and restart are performed on the first day of the year at 00:00.</p>
Signal source	<p>Analog selector and digital selector</p> <p>No selection</p>	<p>Input signal to be counted (digital signal) or integrated (analog signal).</p> <p>For the "Flow (total)" function, the flow process value is used as the signal source.</p> <p>For the "High-speed counter" function, digital input/output 1 is used as the signal source.</p>
Factor	<p>"Counter" and "High-speed counter" function: The counter status is incremented by the factor value for each digital signal pulse. A negative value can be used to form a backwards counter.</p> <p>"Integrator" function: The current measured value of the analog or integer signal is multiplied by the factor and added to the result.</p>	
	-99999 to 1 to +99999	Value or factor

7 Configuration

Parameters	Selection/settings	Description
Time base	"Integrator" function: The current measured value is integrated corresponding to the selected time base, taking the factor into consideration:	
	Second Minute Hour Day	The measured value is divided by 1 and added up every second. The measured value is divided by 60 and added up every second. The measured value is divided by 3600 and added up every second. The measured value is divided by 86400 and added up every second.
	"Operating time" function: The time base specifies the unit in which the operation time is displayed:	
	Second Minute Hour Day	Display in seconds Display in minutes Display in hours Display in days
Threshold value	"Integrator" function: An integration only takes place if the current measured value is greater than the threshold value. The time base and factor are not included in the threshold comparison.	
	-999999999 to 0 to +999999999	Threshold value
Reset signal	The reset signal is used to set the counter and integrator statuses to 0 (independently of other parameters). The current status is not saved in the process. This reset signal is available in addition to the reset signal described in Chapter 7.15.1 "General settings", page 134.	
	Digital selector No selection	The signal (high active) can be selected from the list of digital signals. No signal selected.

Type; additional saving

Selection "yearly (annual)" or "total": the counter/integrator status is temporarily stored at the end of each month, but not reset to 0. This means that the current status is always available for evaluation with the PCA3000 evaluation software at this point in time.

7 Configuration

Device dialog – counter/integrator 1 ... 6 – display

Counter/Integrator 1		11:56:11
Display		
Channel designation	C/I01	
Channel description	Counter/Integrator 01	
Volume unit		
Volume factor		
Unit	hh	
Decimal place	XXXXpX	
Start display range	+0.000000000 l	
End display range	+100000000.0 l	

Parameters

Parameters	Selection/settings	Description
Channel designation	C/I0x Use default text or enter other text.	Name (short description) with max. 5 characters that is used along with the channel description in the visualizations.
Channel description	Counter/Integrator 0x Use default text or enter other text.	Description with max. 21 characters that is used along with the channel designation in the visualizations.
Volume unit	Unit in which the total flow is shown. The unit is displayed wherever the status is displayed in numerical form.	
	l m ³ gal hl By the volume factor	Liters Cubic meters Gallons Hectoliters The total flow (in liters) is multiplied by the volume factor and is displayed in the freely selectable unit.
Volume factor	Conversion factor for evaluating the total flow (for the volume unit "Volume factor")	
	-99999 to 1 to 99999	Factor
Unit	5 characters ()	Unit in which the counter or integrator status is displayed. This is also used if "By the volume factor" is configured as the volume unit. The unit is displayed wherever the status is displayed in numerical form.

7 Configuration

Parameters	Selection/settings	Description
Decimal place	Pre-decimal and decimal places for the numerical display of the counter or integrator status Even if the number of decimal places is fixed, the format is automatically changed if needed in order to display all digits before the decimal point.	
	Auto XXXXXp XXXXpX XXXpXX XXpXXX XpXXXX	Automatic No decimal place One decimal place Two decimal places Three decimal places Four decimal places
Start of display range	-999999999 to 0 to 999999999	Lower limit of the bar graph display
Display range end	-999999999 to 100000000 to 999999999	Upper limit of the bar graph display The counter or integrator status is displayed using a maximum of 9 digits. If this is exceeded, the status restarts from 0.



7 Configuration

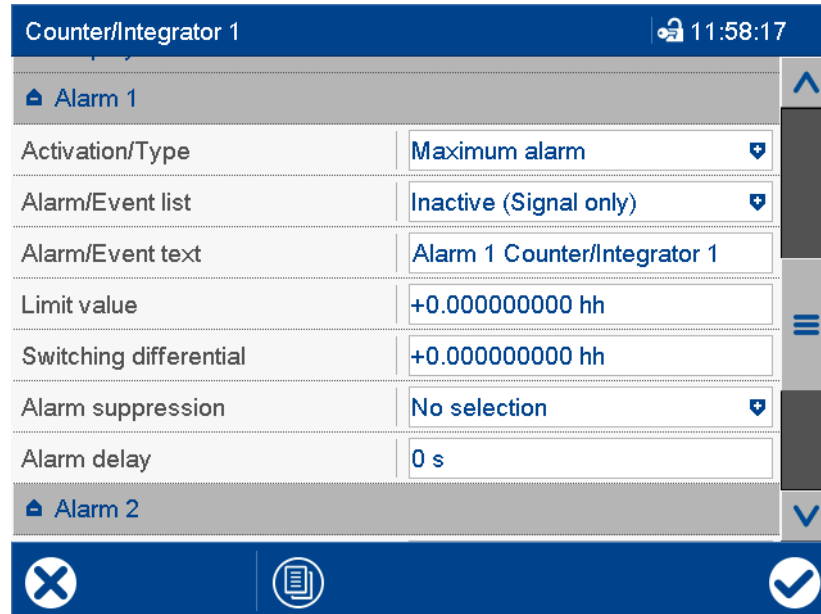

Device dialog – counter/integrator 1 ... 6 – limit value monitoring (alarm 1, alarm 2)

Limit value monitoring with one or two limit values (alarm 1, alarm 2) can be activated for each counter/integrator. In out-of-limit cases, an alarm signal is activated. Depending on the configuration, an entry is made in the event list or additionally in the alarm list. In the latter case, the alarm/event text is displayed in the status bar (until another alarm occurs); the collective alarm is enabled, and the plotter trace may be displayed in a different color.



Parameters

Parameters	Selection/settings	Description
Activation/Type 	Inactive Min. alarm Max. alarm	Limit value monitoring is inactive. Alarm signal is active if the value drops below the limit value. Alarm signal is active if the limit value is exceeded.
Alarm/Event list 	Inactive (signal only) Event Alarm/event	In out-of-limit cases, only the alarm signal is activated. The alarm/event text is entered in the event list. The alarm/event text is entered in the alarm list and the event list. The collective alarm is activated and the text of the last alarm to occur is displayed in the status bar.
Alarm/Event text	Use default text or enter other text.	Text entered in the alarm and event list and displayed in the status bar.
Limit value 	-999999999 to 0 to +999999999	If the limit value is exceeded (max. alarm case) or the value drops below the limit (min. alarm case), an out-of-limit case exists.

Parameters	Selection/settings	Description
Switching differential 	-999999999 to 0 to +999999999	The switching differential is used to suppress constant switching of the alarm signal in the event of minor fluctuations of the current counter status or integrator value around the limit value.
Alarm suppression 	No selection Digital selector	The selected digital signal (high-active) prevents the alarm signal being activated.
Alarm delay 	0 s to 999 s As of device version 02: 0 s to 32767 s	Delay time for alarm signal activation

Activation/type, limit value, switching differential

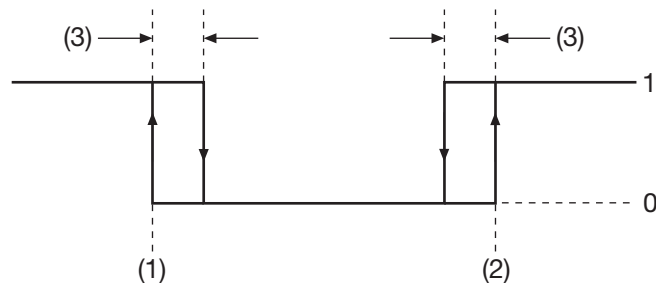

- (1) Limit value for min. alarm
- (2) Limit value for max. alarm
- (3) Switching differential
- 1 Alarm signal on
- 0 Alarm signal off

Alarm/Event list

All events and their time of occurrence are added to the event list. If the event is an alarm, newly occurring alarms and their time of occurrence are additionally added to the alarm list. If an alarm is made inactive, it is removed from the alarm list and the time of removal is added to the event list.

Alarm suppression, alarm delay

Alarm suppression and alarm delay prevent or delay entries being added to the event list and alarm list, activation of the collective alarm, the display in the status bar, and the color change (analog value, plotter trace).

Alarm delay

During an out-of-limit case, the alarm signal is only activated after the delay time has expired. If the limit value infringement no longer exists at that point, the time for the next limit value infringement restarts from zero.

Behavior in the event of fault

If the input signal returns an error value, the alarm signal is activated as long as limit value monitoring is enabled. For this to happen, a min. or max. alarm must be configured (the limit value is unimportant here). Alarm suppression is also taken into consideration in this case, but not the alarm delay.

7 Configuration

7.16 Flow

Two methods are available for flow metering (volume flow, volume per unit of time): computation based on a digital signal (signal type "Digital", e.g., rotary pulse of a paddle wheel) and the evaluation of an analog signal (signal type "Analog signal").



NOTE!

The device must be equipped with a digital I/O card (option) for the "Digital" signal type. The digital signal must be fed into input 1. The minimum frequency is 1 Hz; the maximum frequency 12.5 kHz. At a frequency of < 1 Hz, the flow value is set to 0.

Device dialog (excerpt)

Parameters

Parameters	Selection/settings	Description
Signal type 	Inactive Digital (input/output 01) Analog signal	Flow metering is inactive. Evaluation of rotary pulses from a paddle wheel sensor Evaluation of an analog input signal
Channel designation	FLOW Use default text or enter other text.	Name (short description) with max. 5 characters that is used along with the channel description in the visualizations.
Channel description	Flow Use default text or enter other text.	Description with max. 21 characters that is used along with the channel designation in the visualizations.
Analog signal	Analog selector No selection	Analog signal for determining the flow (only for signal type "Analog signal")
K-Factor 	-99999 to 1 to +99999	Factor for evaluating the measured value for signal type "Digital": pulses per liter

7 Configuration

Parameters	Selection/settings	Description
Unit	Unit in which the flow value is displayed. l/s l/min l/h m ³ /min m ³ /h gal/s gal/min gal/h Customer-specific	Liters per second Liters per minute Liters per hour Cubic meters per minute Cubic meters per hour Gallons per second Gallons per minute Gallons per hour
Factor for customer specific unit (customer-specific factor)	-99999 to 1 to +99999	Factor for evaluating the measured value; only for "customer-specific" unit
Designation unit (customer-specific unit)	l/h Use default text or enter other text.	Flow value unit; only for "customer-specific" unit
Comma format (decimal place)	Number of pre-decimal and decimal places for the numerical display of the measured value Even if the number of decimal places is fixed, the format is automatically changed if needed in order to display all digits before the decimal point. Auto XXXXXp XXXXpX XXXpXX XXpXXX XpXXXX	Automatic No decimal place One decimal place Two decimal places Three decimal places Four decimal places
Start of display range	-99999 to 0 to +99999	Lower limit of display range
Display range end	-99999 to +100 to +99999	Upper limit of display range
Low flow suppression	-99999 to 0 to +99999	Limit value for suppressing low flow values A flow value that is below this limit is no longer recorded. The prefix sign of the low flow is arbitrary and is always determined by the K-factor. The currently selected unit is used as the unit.

Signal type, K-factor

For the "Analog signal" signal type, rescaling via the K-factor can occur in addition to standardization at the analog input. If rescaling is not needed, the K-factor must be set to 1 (default setting).

7 Configuration

For example: The analog input is used to measure the flow velocity (m/sec). The K-factor can be used to determine the flow (l/sec). The K-factor contains the factor for the cross section and a new unit of time in this case.



NOTE!

Signal type "Digital": The input signal is not monitored. In the event of a fault, if the input signal does not deliver any pulses, a value of 0 is determined as the flow. If monitoring is required, a min. alarm with a suitable limit value needs to be configured.

Signal type "Analog signal": In the event of a fault (sensor error or no input signal), the flow value is set to 0. If monitoring is required, a min. alarm with a suitable limit value needs to be configured.

7.16.1 Limit value monitoring

Limit value monitoring with one or two limit values (alarm 1, alarm 2) can be activated for flow metering.

In out-of-limit cases, an alarm signal is activated. Depending on the configuration, an entry is made in the event list or additionally in the alarm list. In the latter case, the alarm/event text is displayed in the status bar (until another alarm occurs); the collective alarm is enabled, and the plotter trace may be displayed in a different color.

This limit value monitoring is independent of the up to six general limit value monitoring values (Configuration > Limit value monitoring) and available in addition to them.



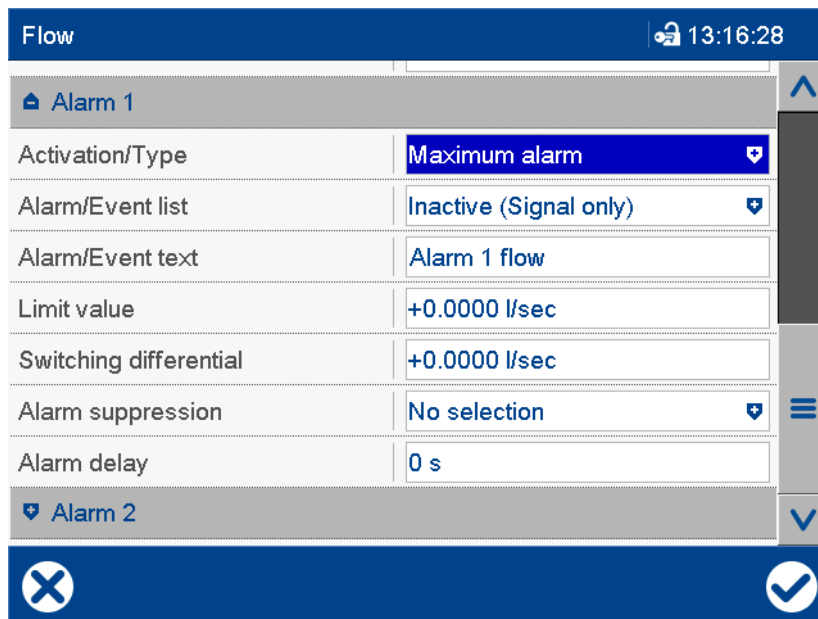

Device dialog



Parameters

Parameters	Selection/settings	Description
Activation/Type 	Inactive Min. alarm Max. alarm	Limit value monitoring is inactive. Alarm signal is active if the value drops below the limit value. Alarm signal is active if the limit value is exceeded.

7 Configuration

Parameters	Selection/settings	Description
Alarm/Event list 	Inactive (signal only) Event Alarm/event	In out-of-limit cases, only the alarm signal is activated. The alarm/event text is entered in the event list. The alarm/event text is entered in the alarm list and the event list. The collective alarm is activated and the text of the last alarm to occur is displayed in the status bar.
Alarm/Event text	Use default text or enter other text.	Text entered in the alarm and event list and displayed in the status bar.
Limit value 	-99999 to 0 to +99999 l/s	If the limit value is exceeded (max. alarm case) or the value drops below the limit (min. alarm case), an out-of-limit case exists.
Switching differential 	0 to 99999 l/s	The switching differential is used to suppress constant switching of the alarm signal in the event of minor fluctuations of the input signal around the limit value.
Alarm suppression 	Digital selector No selection	The selected digital signal (high-active) prevents the alarm signal being activated.
Alarm delay 	0 s to 999 s As of device version 02: 0 s to 32767 s	Delay time for alarm signal activation

7 Configuration

Activation/type, limit value, switching differential

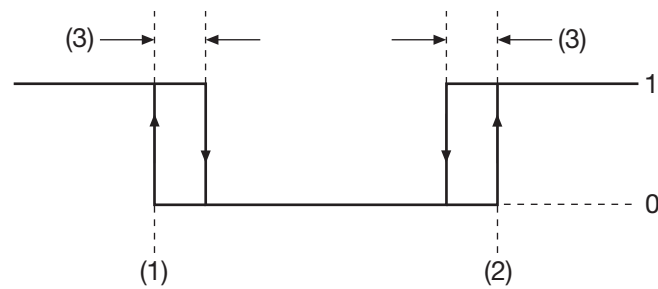

- (1) Limit value for min. alarm
- (2) Limit value for max. alarm
- (3) Switching differential

- 1 Alarm signal on
- 0 Alarm signal off

Alarm/Event list

All events and their time of occurrence are added to the event list. If the event is an alarm, newly occurring alarms and their time of occurrence are additionally added to the alarm list. If an alarm is made inactive, it is removed from the alarm list and the time of removal is added to the event list.

Alarm suppression, alarm delay

Alarm suppression and alarm delay prevent or delay entries being added to the event list and alarm list, activation of the collective alarm, the display in the status bar, and the color change (analog value, plotter trace).

Alarm delay

During an out-of-limit case, the alarm signal is only activated after the delay time has expired. If the limit value infringement no longer exists at that point, the time for the next limit value infringement restarts from zero.

Behavior in the event of fault

If the input signal returns an error value, the alarm signal is activated as long as limit value monitoring is enabled. For this to happen, a min. or max. alarm must be configured (the limit value is unimportant here). Alarm suppression is also taken into consideration in this case, but not the alarm delay.

7.17 Math

The optional math function (extra code 260 "Math/Logic") supports six formulas (Math 1 to Math 6), which can be freely used for mathematical calculations (analog values).

In addition, functions for calculating the differential, ratio, and relative humidity are also provided. In this case, two analog values (variables a and b), for example, the measured values of analog input 1 and 2 are linked to each other. The dry-bulb temperature and the wet-bulb temperature are required for calculating the relative humidity and should be determined with a psychrometric humidity sensor.

There is also a function for calculating a floating average.

The results are available in the analog selector. If the function is not active, the math value = 0. One digital signal each (0/1) is derived from the results of Math 1 to Math 6. The value is 0 if the result is invalid.

Activating the function

On the device, the math function is only available when activated. To do so, the extra code "Math/Logic" must first be activated in the setup program using an activation code (Setup program: Online parameters > Enabling of extra codes).

The math function is available in the setup program after enabling the "Math/Logic" option (Configuration: Basic device > Math/Logic).

Device dialog (excerpt)

Mathematics 1		09:55:59
Function	Formula	▲
Channel name	Mat01	
Channel description	Mathematics 01	
Temperature	None	☑
Unit	%	
Start display range	+0.0000 %	
End display range	+100.00 %	
Comma format	XXXXpX	☑
Behaviour in the event of fault	Output error value	☑

Navigation icons: [Close] [List] [Confirm]

7 Configuration

Parameters

Parameters	Selection/settings	Description
Function 	Without function Formula Differential (a-b) Ratio (a/b) Humidity (a;b) Floating average (a;t)	Function is switched off. Mathematical links with freely selectable variables and operators Differential of variable a and variable b Ratio of variable a to variable b Calculation of relative humidity Variable a: Dry-bulb temperature Variable b: Wet-bulb temperature Floating average of variable a (sampling interval 1 s)
Channel name (designation)	Mat0x Use default text or enter other text.	Name (short description) with max. 5 characters that is used along with the channel description in the visualizations.
Channel description	Mathematics 0x Use default text or enter other text.	Description with max. 21 characters that is used along with the channel designation in the visualizations.
Temperature	None Temperature difference Temperature value	The math result is displayed in the entered unit The math result is a temperature difference and is shown in °C or °F (depending on the device settings). The math result is a temperature value and is shown in °C or °F (depending on the device settings).
Unit	5 characters (%)	Unit in which the math result (analog value) is displayed.
Start of display range	-99999 to 0 to +99999	Lower limit of display range for graphical display
Display range end	-99999 to 100 to +99999	Upper limit of display range for graphical display
Comma format (decimal place)	Number of pre-decimal and decimal places for the numerical display of the math result Even if the number of decimal places is fixed, the format is automatically changed if needed in order to display all digits before the decimal point.	
	Auto XXXXXp XXXXpX XXXpXX XXpXXX XpXXXX	Automatic No decimal place One decimal place Two decimal places Three decimal places Four decimal places

7 Configuration

Parameters	Selection/settings	Description
Behavior in the event of fault	Behavior if the math function does not produce a valid result due to an invalid input value.	
	Output error value	The math error value 5.0E+37 is output.
	Output replacement value	The replacement value is output.
Replacement value	-99999 to 0 to +99999	Replacement value for output in the event of fault.
Time const. for average value (min)	1 to 9999	Time constant in minutes for calculating the floating average
Variable a	Analog selector	Analog signal a (for calculating the differential, ratio, and humidity, and determining the floating average)
Variable b	Analog selector	Analog signal b (for calculating the differential, ratio, and humidity)

Function

The formula is created with the setup program. The available functions are differential, ratio, moisture, and floating average; they can be used individually in the formula.

If the "Formula" function is selected although no formula has been stored, an error value is output (display "---").

Setup dialog

The screenshot shows the 'Mathematics' configuration dialog. On the left, a tree view lists 'Mathematics 1' through 'Mathematics 6', with 'Mathematics 1' selected. The main configuration area includes the following fields:

- Function: Formula
- Channel name: Mat01
- Channel description: Mathematics 01
- Temperature: None
- Unit: %
- Start display range: 0 %
- End display range: 100 %
- Comma format: XXXXpX
- Replacement value: Output error value
- Replacement value: 0 %
- Time const for aver. val. (min): 1
- Variable a: (empty selector)
- Variable b: (empty selector)

At the bottom, there is a 'Formula as text' field and a 'Formula Editor' button. The dialog also features 'Copy', 'OK', and 'Cancel' buttons.

7 Configuration

Parameters

Parameters	Selection/settings	Description
Formula as text 		View with the formula created using the Formula Editor The formula can also be edited in this field.

All other parameters and their settings are identical to the configuration on the device.

Formula as text, Formula Editor

Pressing the "Formula Editor" button opens an editor that can be used to create formulas by selecting variables and operators (max. 600 ASCII characters). Formulas can be entered freely in line with standard mathematical rules. Any number of spaces may be used within the formula symbol string. Spaces are not admissible in function designations, names of variables, or constants.



NOTE!

The trigonometric functions (SIN, COS, and TAN operators) use degrees (360).

Error handling

The following circumstances may arise:

Process value of math function	Configuration "Behavior in the event of fault"	Initial value of math function	Binary value of math function
None (math function inactive)	Any	3.0E+37	0 (FALSE)
No error value	Any	Value of math function	0 (FALSE)
Error value	Output error value	5.0E+37	1 (FALSE)
Error value	Output replacement value	Replacement value	1 (FALSE)

Status after change of configuration

Modified parameters are incorporated immediately.

Behavior after power on

All math values are set to 3.0E+37 and calculations are restarted.

7.17.1 Limit value monitoring

Limit value monitoring with one or two limit values (alarm 1, alarm 2) can be activated for the results of the math functions math 1 to math 6. In out-of-limit cases, an alarm signal is activated. Depending on the configuration, an entry is made in the event list or additionally in the alarm list. In the latter case, the alarm/event text is displayed in the status bar (until another alarm occurs); the collective alarm is enabled, and the plotter trace may be displayed in a different color.

This limit value monitoring is independent of the up to six general limit value monitoring values (Configuration > Limit value monitoring) and available in addition to them.

Device dialog

Mathematics 1 13:34:43

Alarm 1

Activation/Type	Maximum alarm
Alarm/Event list	Inactive (Signal only)
Alarm/Event text	Alarm 1 Mathematics 1
Limit value	+0.0000 %
Switching differential	+0.0000 %
Alarm suppression	No selection
Alarm delay	0 s

Alarm 2

Navigation icons: Close (X), Back (List), Confirm (Checkmark)

Parameters

Parameters	Selection/settings	Description
Activation/Type 	Inactive Min. alarm Max. alarm	Limit value monitoring is inactive. Alarm signal is active if the value drops below the limit value. Alarm signal is active if the limit value is exceeded.
Alarm/Event list 	Inactive (signal only) Event Alarm/event	In out-of-limit cases, only the alarm signal is activated. The alarm/event text is entered in the event list. The alarm/event text is entered in the alarm list and the event list. The collective alarm is activated and the text of the last alarm to occur is displayed in the status bar.
Alarm/Event text	Use default text or enter other text.	Text entered in the alarm and event list and displayed in the status bar.
Limit value 	-99999 to 0 to +99999	If the limit value is exceeded (max. alarm case) or the value drops below the limit (min. alarm case), an out-of-limit case exists.
Switching differential 	0 to 99999	The switching differential is used to suppress constant switching of the alarm signal in the event of minor fluctuations of the input signal around the limit value.
Alarm suppression 	No selection Digital selector	The selected digital signal (high-active) prevents the alarm signal being activated.

7 Configuration

Parameters	Selection/settings	Description
Alarm delay 	0 s to 999 s As of device version 02: 0 s to 32767 s	Delay time for alarm signal activation

Activation/type, limit value, switching differential

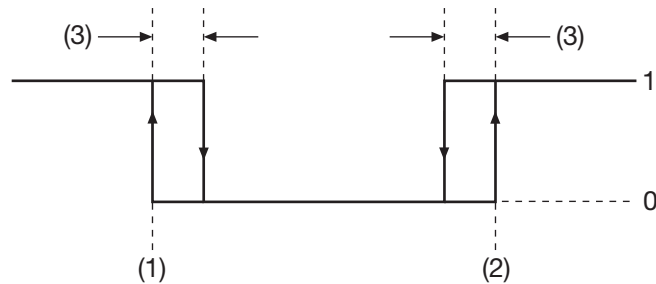

- | | |
|--------------------------------|--------------------|
| (1) Limit value for min. alarm | 1 Alarm signal on |
| (2) Limit value for max. alarm | 0 Alarm signal off |
| (3) Switching differential | |

Alarm/Event list

All events and their time of occurrence are added to the event list. If the event is an alarm, newly occurring alarms and their time of occurrence are additionally added to the alarm list. If an alarm is made inactive, it is removed from the alarm list and the time of removal is added to the event list.

Alarm suppression, alarm delay

Alarm suppression and alarm delay prevent or delay entries being added to the event list and alarm list, activation of the collective alarm, the display in the status bar, and the color change (analog value, plotter trace).

Alarm delay

During an out-of-limit case, the alarm signal is only activated after the delay time has expired. If the limit value infringement no longer exists at that point, the time for the next limit value infringement restarts from zero.

Behavior in the event of fault

If the input signal returns an error value, the alarm signal is activated as long as limit value monitoring is enabled. For this to happen, a min. or max. alarm must be configured (the limit value is unimportant here). Alarm suppression is also taken into consideration in this case, but not the alarm delay.

7.18 Logic

The optional logic function (extra code 260 "Math/Logic") supports six formulas (Logic 1 to Logic 6), which can be freely used for logical links (binary values).

The results are available in the digital selector. If the function is not active, the logical value = 0.

Activating the function

On the device, the Logic function is only available when activated. To do so, the extra code "Math/Logic" must first be activated in the setup program using an activation code (Setup program: Online parameters > Enabling of extra codes).

The Logic function is available in the setup program after enabling the "Math/Logic" option (Configuration: Basic device > Math/Logic).

Device dialog

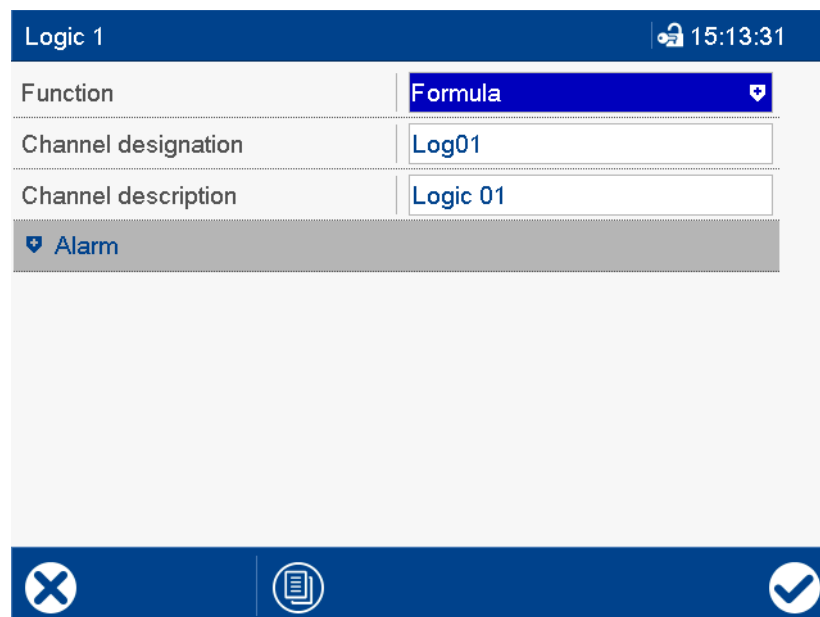

Parameters

Parameters	Selection/settings	Description
Function 	Without function Formula	Function is switched off. Logical links with freely selectable variables and operators The formula is created with the setup program.
Channel designation	Log0x Use default text or enter other text.	Name (short description) with max. 5 characters that is used along with the channel description in the visualizations.
Channel description	Logic 0x Use default text or enter other text.	Description with max. 21 characters that is used along with the channel designation in the visualizations.

7 Configuration

Setup dialog

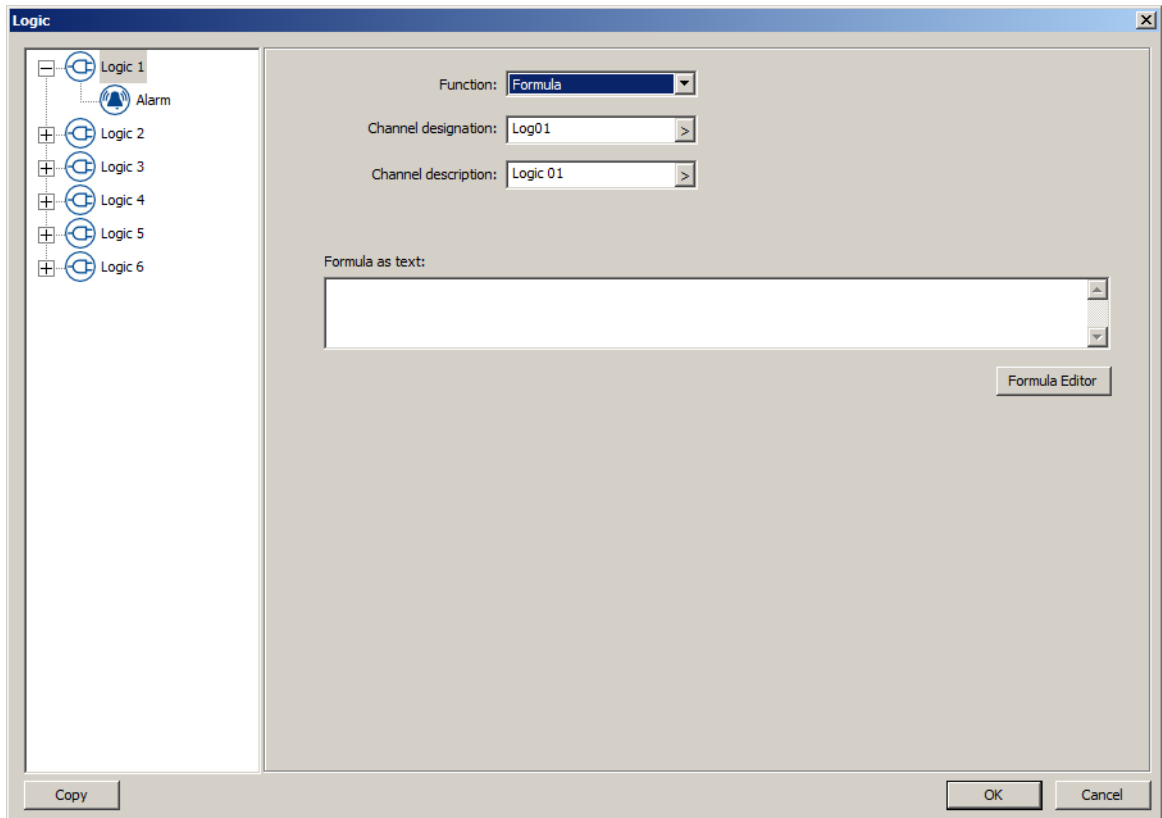

Parameters

Parameters	Selection/settings	Description
Formula as text 		View of the formula created with the Formula Editor (max. 600 ASCII characters) The formula can also be edited in this field.

All other parameters and their settings are identical to the configuration on the device.

Formula as text, Formula Editor

Pressing the "Formula Editor" button opens an editor that can be used to create formulas by selecting variables and operators (max. 600 ASCII characters). Formulas can be entered freely in line with standard Boolean rules. Any number of spaces may be used within the formula symbol string. Spaces are not admissible in function designations, names of variables, or constants.

Status after change of configuration

Modified parameters are incorporated immediately.

Behavior after power on

All logic values are set to 0 and calculations are restarted.

7.18.1 Signal monitoring

Signal monitoring (alarm) can be activated for the results of Logic 1 to Logic 6.

In alarm cases, an alarm signal is activated. Depending on the configuration, an entry is made in the event list or additionally in the alarm list. In the latter case, the alarm/event text is displayed in the status bar (until another alarm occurs); the collective alarm is enabled, and the plotter trace may be displayed in a different color.

Device dialog

Logic 1		15:14:41
Channel designation	Log01	↑
Channel description	Logic 01	
Alarm		
Activation	Active	↓
Alarm/Event list	Inactive (Signal only)	≡
Alarm at level	High (1)	↓
Alarm/Event text	Alarm Logic 01	
Alarm delay	0 s	
Alarm suppression	No selection	↓

Parameters

Parameters	Selection/settings	Description
Activation	Inactive Active	Signal monitoring is inactive. Signal monitoring is active.
Alarm/Event list 	Inactive (signal only) Event Alarm/event	In the event of an alarm, only the alarm signal is activated. The alarm/event text is entered in the event list. The alarm/event text is entered in the alarm list and the event list. The collective alarm is activated and the text of the last alarm to occur is displayed in the status bar.
Alarm active at	High (1) Low (0)	Alarm at high level (1) Alarm at low level (0)
Alarm/Event text	Use default text or enter other text.	Text entered in the alarm and event list and displayed in the status bar.
Alarm delay 	0 s to 999 s As of device version 02: 0 s to 32767 s	Delay time for alarm signal activation
Alarm suppression 	Digital selector No selection	The selected digital signal (high-active) prevents the alarm signal being activated.

7 Configuration

Alarm/Event list

All events and their time of occurrence are added to the event list. If the event is an alarm, newly occurring alarms and their time of occurrence are additionally added to the alarm list. If an alarm is made inactive, it is removed from the alarm list and the time of removal is added to the event list.

Alarm delay

In the event of an alarm (parameter "Alarm active at"), the alarm signal is not activated until the delay time has expired. If the alarm case is left in the meantime, the timer restarts when a new alarm case occurs.

Alarm delay, alarm suppression

Alarm delay and alarm suppression delay or prevent entries being added to the event list and alarm list, activation of the collective alarm, and display in the status bar.

7 Configuration

Parameters

Parameters	Selection/settings	Description
Status	General settings of the group	
	Inactive (default setting for groups 2 to 4)	The group data are neither displayed nor saved.
	Display only	The group data is displayed on the screen.
	Display/Save (default setting for group 1)	The group data is displayed on the screen and saved. The group data can only be evaluated using a PC if it has been saved.
Name	Use default text or enter other text.	Description of the group, with a max. length of 15 characters. The description is displayed in the individual visualizations.

7.19.2 Analog channels

A group can consist of up to six analog channels (Channel 1 to Channel 6).

Device dialog

Parameters

Parameters	Selection/settings	Description
Input signal 	Analog selector No selection	Signal source for the channel Default setting for group 1: Channel 1: Analog input 1 Channel 2: Analog input 2 Channel 3: Analog input 3

7 Configuration

Parameters	Selection/settings	Description
Line width	Determines the width of the graphic measured value display.	
	Thin	Thin line width (1 pixel)
Tolerance band active	Thick	Thick line width (2 pixels)
	Available from channel 2 of a group.	
Maximum (upper) tolerance band limit	No, Yes	If "Yes", the channel is compared with channel 1 of the group. It must be ensured that channel 1 of the group is active (Input signal <> No selection).
	Only available for channel 1 of a group.	
Minimum (lower) tolerance band limit	0 to 10 to 100	The "Upper tolerance band limit" and the current measured value of channel 1 form the upper limit of the tolerance band.
	Only available for channel 1 of a group.	
Maximum (upper) switching differential	-100 to -10 to 0	The "Lower tolerance band limit" and the current measured value of channel 1 form the lower limit of the tolerance band.
	Only available for channel 1 of a group.	
Minimum (lower) switching differential	-100 to -2 to 0	If there is a positive tolerance violation, the current measured value from channel 2 to 6 must first drop below the current measured value of channel 1, plus the upper tolerance band limit and upper switching differential, in order for the alarm to be canceled.
	Only available for channel 1 of a group.	
Alarm text maximum (upper) limit	0 to 2 to 100	If there is a negative tolerance violation, the current measured values from channel 2 to 6 must first exceed the current measured value of channel 1, plus the lower tolerance band limit and lower switching differential, in order for the alarm to be canceled.
	Available from channel 2 of a group.	
Alarm text minimum (lower) limit	Use default text or enter other text.	The text entered (max. 31 characters) is displayed and entered in the alarm and event list if the selected channel exits the tolerance in positive direction.
	Available from channel 2 of a group.	
Alarm text minimum (lower) limit	Use default text or enter other text.	The text entered (max. 31 characters) is displayed and entered in the alarm and event list if the selected channel exits the tolerance in negative direction.
	Available from channel 2 of a group.	

7 Configuration

Input signal

Channel 1 has a special task; it is used as the reference curve for the other channels in the group. All other channels in the group can be compared with channel 1 independent of one another. If the configured tolerance band is exited, there is an alarm, and an alarm text is displayed in the "status and title line" and in the alarm list and event list.



NOTE!

The tolerance band comparison is only possible within the scaling limits. If there is a channel that falls below or exceeds the range, this will result in both a min. and a max. alarm as with all other functions (in this case, pos. tolerance and neg. tolerance).

Example of tolerance band being exceeded

The principle of the alarm corresponds to the alarm configuration of the individual analog channels.

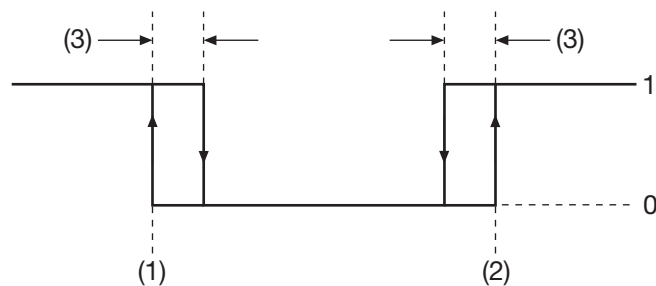

- (1) Lower alarm
- (2) Upper alarm
- (3) Switching differential

- 1 Alarm on
- 0 Alarm off

Channel 1: Measured value = 21 °C (reference value)

Upper tolerance band limit = 10 °C

Upper switching differential = -2 °C

Channel 2: Tolerance band is active.

The alarm is generated if the current measured value from channel 2 is above 31 °C.

The alarm is canceled again if the current measured value drops below 29 °C.

Channel 1: Measured value = 21 °C (reference value)

Upper tolerance band limit = -10 °C

Lower switching differential = 2 °C

Channel 2: Tolerance band is active.

The alarm is generated if the current measured value from channel 2 is below 11 °C.

The alarm is deleted again if the current measured value exceeds 13 °C.



NOTE!

In the example shown, channel 1 is constant and channel 2 changes its measured value. This does not have to be the case. It can also be the case that channel 1 changes or even that both channels change.

7.19.3 Digital channels

A group can consist of up to six digital channels (Channel 1 to Channel 6).

Device dialog

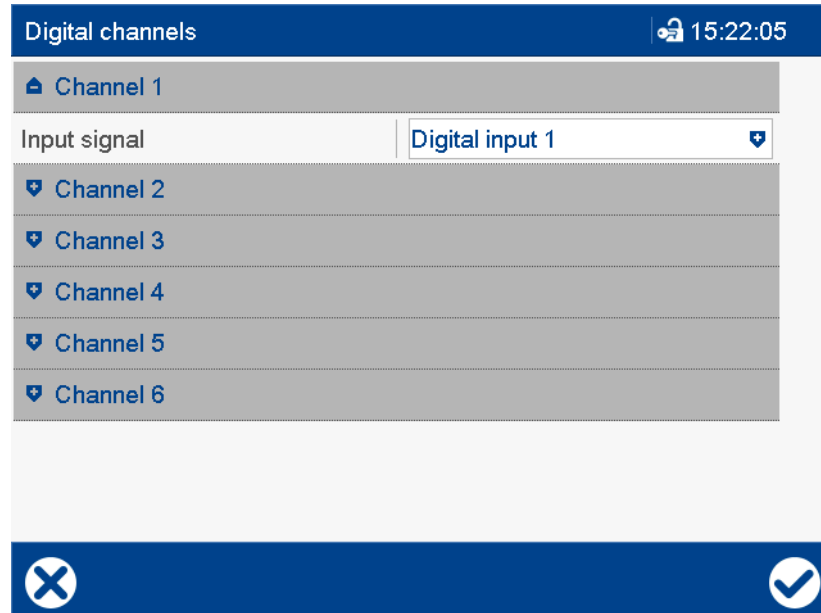

Parameters

Parameters	Selection/settings	Description
Input signal	Digital selector No selection	Signal source for the channel

7.19.4 Diagram view

Device dialog

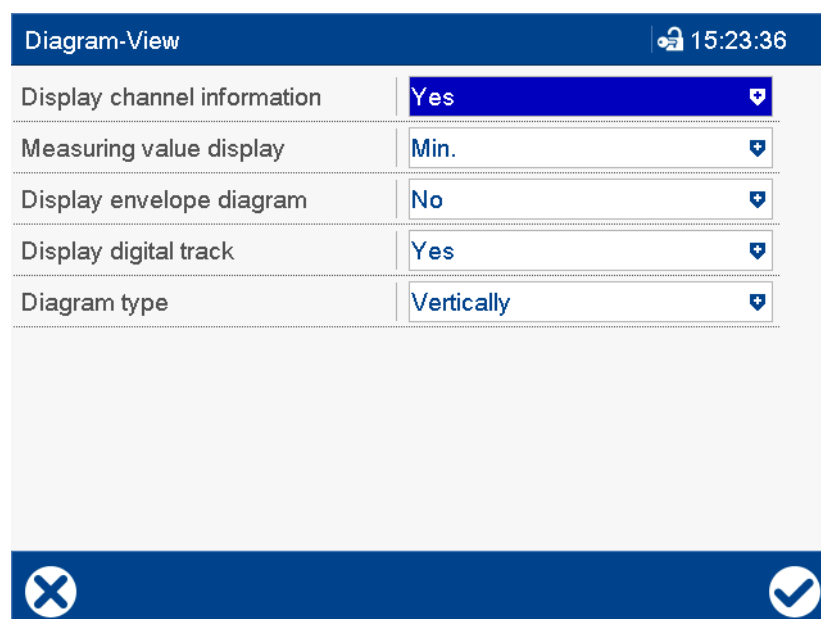

7 Configuration

Parameters

Parameters	Selection/settings	Description
Display channel information	This parameter is used to enable and disable the channel information display in the curve diagram: channel identifier (e.g., A1) along with the short description of the analog or digital signal (e.g., AE01 for analog input 1) and numerical display of the analog value.	
	No	Display disabled
	Yes	Display enabled
Measured value display	The parameter determines which value is shown in the diagram header (only for curve diagrams and when min./max. value recording is enabled; see the parameter "Memory values").	
	Min.	The min. value is displayed.
	Max.	The max. value is displayed.
Display envelope diagram	The parameter determines whether the measured values are shown as an envelope curve or a line in the curve view (only for curve diagrams and when min./max. value recording is enabled; see the parameter "Memory values"). If the data is not stored as min./max. values, the parameter has no effect.	
	No	The min./max. values are displayed as a line.
	Yes	The min./max. values are displayed as an envelope curve.
Display digital track (digital traces)	This parameter determines whether the digital traces (digital signals) are shown in the curve presentation along with the analog signals.	
	No	The digital signals are not displayed.
	Yes	Digital and analog signals are displayed.
Diagram type	The diagram can be displayed vertically or horizontally.	
	Vertical	Diagram runs from the top down.
	Horizontal	Diagram runs from the right to left.

7.19.5 Standard operation

When standard operation is activated, the measurement data is recorded at the configured memory cycle unless one of the following operating modes is active:

- Event operation
- Time operation

Standard operation has the lowest priority compared with time and event operation.

Device dialog

Standard operation
🔒 15:28:57

Memory status	On ▼
Memory values	Average value ▼
Memory cycle	5 s

✕
✓

Parameters

Parameters	Selection/settings	Description
Memory status 	On Off	The data is saved if this operating mode is active. The data is not saved if this operating mode is active.
Memory values 	Average value Current value Min. value Max. value Min./Max. value	The average value across the configured memory cycle is calculated and saved. The current value at the end of the memory cycle is stored. If the signal returns an error value during the memory cycle, even if this is only for a short time, the value is stored. The minimum value within the configured memory cycle is stored. The maximum value within the configured memory cycle is stored. The minimum and maximum values within the configured memory cycle are stored.

7 Configuration

Parameters	Selection/settings	Description
Memory cycle	0 s ... 5 s ... 32000 s	<p>The memory cycle is configured here. Depending on the configuration of the "Memory values" parameter, the measurement data is saved when the configured time has elapsed. The smaller the memory cycle, the more data needs to be saved.</p> <p>If "0 s" is configured, the device uses the fastest possible cycle; in other words, it stores the measured values every 125 ms (high-speed mode).</p>

Memory status

The operating mode "Standard operation" is only available if memory status is switched on.



NOTE!

If the memory status is switched off and neither event operation nor time operation is active, only events will be recorded but measurement data will not be saved.

Memory values

For a digital signal the following values are stored depending on the "Memory values" parameter:

"Memory values" parameter	Stored value
Average value	High (1), if the digital signal assumes this value once during the memory cycle, otherwise Low (0)
Current value	Current value at the time of storing
Min. value	Low (0), if the digital signal assumes this value once during the memory cycle, otherwise High (1)
Max. value	High (1), if the digital signal assumes this value once during the memory cycle, otherwise Low (0)
Min./Max. value	High (1), if the digital signal assumes this value once during the memory cycle, otherwise Low (0)

7.19.6 Event operation

Event operation is enabled by a control signal; it can be used, for example, to shorten a memory cycle during an alarm.

Event operation has the highest priority of all three operating modes.

Device dialog

Parameters

Parameters	Selection/settings	Description
Control signal	Digital selector No selection	Signal that starts and stops an event operation (high active).
Memory values		⇒ Chapter 7.19.5 "Standard operation", page 164
Memory cycle	0 s ... 1 s ... 32000 s	⇒ Chapter 7.19.5 "Standard operation", page 164

7.19.7 Time operation

A time frame is defined for time operation (max. 24 hours); during this period, a specific memory value and a specific memory cycle are active.

Time operation has higher priority compared with standard operation, but lower priority than event operation.

7 Configuration

Device dialog

Time operation
 15:31:51

Begin	<input style="width: 100%;" type="text" value="00:00:00"/>
End	<input style="width: 100%;" type="text" value="00:00:00"/>
Memory values	<input style="width: 100%;" type="text" value="Average value"/>
Memory cycle	<input style="width: 100%;" type="text" value="1 s"/>

Parameters

Parameters	Selection/settings	Description
Begin	00:00:00	Time at which to start time operation. Start = End: Time operation is inactive.
End	00:00:00	Time at which to end time operation again. Start = End: Time operation is inactive.
Memory values		⇒ Chapter 7.19.5 "Standard operation", page 164
Memory cycle	0 s ... 1 s ... 32000 s	⇒ Chapter 7.19.5 "Standard operation", page 164

7.20 Report

A report can be generated for each of the four groups. The maximum value, the minimum value, and the average value of each analog channel referring to the selected reporting period are saved in a report.



NOTE!

Processing changes to configuration:

All reports are completed, saved, and restarted. The values of the completed reports in the device are set to empty, "----". In this case, the results of the completed reports can only be viewed with the PCA3000 software.



NOTE!

Automatic intermediate results of the "Total" and "Yearly" reports:



The "Total" and "Yearly" reports are saved once a month at the turn of the month, independently of other reports. These are not completed, but continue to run.

Device dialog

Parameters

Parameters	Selection/settings	Description
Daily	Specifies whether a report runs for a day (24 hours). Completion and restart are determined by the synchronization time parameter.	
	Off, On	If "On", the daily report runs.
Weekly	Specifies whether a report runs for a week. Completion and restart are determined by the weekday and synchronization time parameters.	
	Off, On	If "On", the weekly report runs.
Weekday	Sunday to Saturday	Weekday is used in combination with the synchronization time parameter as the report end and restart for the weekly report.

7 Configuration

Parameters	Selection/settings	Description
Monthly	Specifies whether a report runs for a month. Completion and restart occur at 00:00 on the first day of the month.	
	Off, On	If "On", the monthly report runs.
Annually	Specifies whether a report runs for a whole year. Completion and restart occur at 00:00 on the first day of the year	
	Off, On	If "On", the yearly report will be run.
Total	Total specifies whether a report is to be run for the total duration of the current configuration of the device.	
	Off, On	If "On", the total report will be run.
Periodically	Specifies whether a periodic report runs. Completion and restart are determined by the period and synchronization time parameters.	
	Off, On	If "On", the periodical report runs.
Period	1 min to 12 h	Period is used as the report end and restart for the periodical report.
Report by control signal 	Specifies whether an external report runs while the control signal is active.	
	Off, On	If "On", the external report will be run.
Control signal	Digital selector No selection	Control signal (high active) for the external report
Synchronization time 	Synchronization time is used as the report end and restart for the daily, weekly, and periodical report.	
	00:00:00	Time of synchronization
Outside the measuring range 	This parameter decides what happens if an analog channel is outside of the valid measuring range (scaling).	
	Stop report	The reports for this channel are stopped. If the measured values are within the measuring range limits, these will be restarted.
	Delete report	The reports are set to invalid ("----") and only restarted following the configured report end.

Report by control signal



NOTE!

Within 5 seconds, only one external report is started in a group, i.e. a new external start prior to 5 seconds having elapsed will be ignored. If the start signal is still on after 5 seconds, the external report is started immediately. If the start signal is no longer on, the report is not restarted.

Synchronization time

The synchronization time parameter will be explained in more detail below, using the example of a periodical report.

The stop and restart is performed at the next point in time occurring in the time grid – depending on the synchronization time and period.

Example:

Period = 2 hours

Synchronization time = 11:30:00

Power on = 09:11:00

1st period from 09:11 to 09:30 = 19 minutes

2nd period from 09:30 to 11:30 = 2 hours

3rd period from 11:30 to 13:30 = 2 hours

etc.

**NOTE!**

The principle is the same for all reports relating to the synchronization time (daily, weekly, and periodical report). For a daily report, the first report will usually not run for 24 hours and the first weekly report will usually not run for 7 days.

7 Configuration

7.21 Batch

The device supports batch reporting. The batch data is recorded along with the channels for the groups and displayed in batch visualizations.



NOTE!

To use batch reporting at least one group must be active.

7.21.1 General Information



Device dialog

Generally		16:10:42
Batch active	Yes	^
Batch name	Batch 1	
Batch start	Touchscreen	^
Control signal		
Recipe head	Recipe	
Text selection Bit 0	No selection	^
Text selection Bit 1	No selection	^
Text selection Bit 2	No selection	^
Text selection Bit 3	No selection	^

Parameters

Parameters	Selection/settings	Description
Batch active	Yes, No	The selected batch can only be configured if "Yes".
Batch name	Batch x	Description with a maximum length of 15 characters that is used in visualizations.
Batch start	Barcode Inactive Control signal Touchscreen	Start and stop of batch reporting is controlled by a barcode scanner. Batch is not recorded. Start and stop of batch reporting is controlled by a digital signal. Start and stop of batch reporting is controlled by a button on the screen.

7 Configuration

Parameters	Selection/settings	Description
Control signal	Digital selector No selection	Signal that is used to start and stop batch reporting (high active). The parameter is only available for batch start via "Control signal".
Recipe header 	Recipe	The recipe header is displayed for a completed batch as a title above a comment text (e.g., Recipe).
Text selection bit 0 to Text selection bit 5 	Digital selector No selection	Bit 0 (LSB) to Bit 5 (MSB) form a binary number which defines the batch text, taking the text offset into account.

Recipe header

The comment text can contain up to 400 characters (20 lines each with 20 characters each); it is used to describe the batch. It is only transferred via an interface to the device (Modbus address 0xA000) and can only be displayed with the PCA3000 PC Evaluation Software.



NOTE!

Before ending batch reporting, a comment text must exist on the device for it be added to the batch report. After completing batch reporting, the comment text is deleted again. If it is to be used multiple times, the user must resend it to the device for each instance of batch reporting.

Text selection bit ...

The setup program can be used to created up to 128 different batch texts (Text list: Text 1 to Text 128). 64 of the 128 batch texts are available for selection by digital signals; the first selectable text is determined by the "First text" parameter of the batch line.

First text + binary number = Number of batch text used

Text selection bit 0 has a priority of 2^0 , text selection bit 1 a priority of 2^1 , etc.:

Bit 5	Bit 4	Bit 3	Bit 2	Bit 1	Bit 0	Decimal value
0	0	0	0	0	0	0
0	0	0	0	0	1	1
0	0	0	0	1	0	2
0	0	0	0	1	1	3
.
1	1	1	1	1	1	63

0 = "No selection" in the digital selector or signal is inactive.

1 = Signal selected and signal is active (high active).

Examples:

First text = 1; Text selection bits: 000000 (= 0); Batch text = 1 + 0 = 1 (Text 1)

First text = 1; Text selection bits: 111111 (= 63); Batch text = 1 + 63 = 64 (Text 64)

First text = 65; Text selection bits: 111111 (= 63); Batch text = 65 + 63 = 128 (Text 128)

If the result (text number) is greater than 128, no text is shown ("-----").

7 Configuration

7.21.2 Batch lines

Device dialog

Batch line 1		🔒 16:11:49
Text left column	<input type="text" value="Program name"/>	
Content right column	<input type="text" value="Selection from text list"/>	
Default text	<input type="text" value="Text 1"/>	
Delete line	<input type="text" value="Yes"/>	
First text	<input type="text" value="1"/>	
Number of texts	<input type="text" value="17"/>	
Editable	<input type="text" value="Yes"/>	

Parameters

Parameters	Selection/settings	Description
Text left column	Program name (in line 1) Use default text or enter other text.	This parameter specifies the text in the left column for the selected line of the batch report.

7 Configuration

Parameters	Selection/settings	Description
Contents of right column		The formation of the text in the right column of a batch report is specified here.
	No entry	The field remains empty.
	Default text	A set text – defined by the "Default text" parameter – is used.
	Selection from the text list	The user can select the text from a list with max. 128 device-internal batch texts. After reconfiguration, the default text is initially displayed; the user must select the desired text from the list in the "Current batch" visualization. The batch texts can be defined in the setup program.
	Selection by digital signal	One of the 128 internal batch texts of the device is used. The selection is performed using a maximum of 6 digital signals (text selection bits). The batch texts can be defined in the setup program.
	Batch name	The batch name is displayed.
	Batch number	The batch number is used along with a text (default text). The batch number is incremented at the end of batch reporting. It can be pre-assigned using the device in the parameterization menu.
	Batch start	Start (date and time) of batch reporting
	Batch end	End (date and time) of batch reporting
	Batch duration	Time difference between batch start and batch end
	Barcode	The text in the selected line is to be filled by a barcode scanner.
	User name	Name of logged on user
	External text variable 1 to External text variable 10	Text that can be sent to the device via the interface (as of Modbus address 0x1218 or 0x1540). As of device version 02 the external text variables can also be written by a barcode scanner (see Chapter 11.4.2 "Enter event texts and process values", page 271).
Default text	Text x	The text is used in the current batch report if the text in the right column is composed of "Default text" or "Batch number". For "Select from text list" or "Barcode," the text is used as a default.

7 Configuration

Parameters	Selection/settings	Description
Delete line		This parameter decides whether or not an editable batch text (in the right column) is reset after a batch is completed.
	Yes, No	If "Yes", the text (max. 160 characters) in the right column is replaced with its original content at the batch end (default text).
First text	1 ... 128	This parameter is available if the text in the right column is composed of the internal text list ("Select from text list" or "Select through digital signals"). It is the first text on the list which the user can select.
Number of texts	128 ... 1	This parameter is available if the text in the right column is composed of the internal text list ("Select from text list"). It is the last text on the list which the user can select. In the setup program, the selectable texts are shown in a separate window during the configuration. $0 < \text{number} \leq (129 - \text{first text})$
Editable		This parameter enables editing of the text within the current batch report.
	Yes, No	If "No," the text in the right column can only be edited by modifying the "Default text". If "Yes", the text in the right column – for the current batch report – can be changed. Depending on the "Delete line" parameter, the configured text can be reactivated automatically after the batch report is completed.

7.22 Ethernet

The device may be integrated in a company network via the Ethernet interface.

The following functions are available via Ethernet:

- Communication with PC software such as the setup program, PCC, PCA3000
- Web server for using a web browser
- Communication with SNTP servers and email servers (SMTP)
- Communication with a Modbus master or slave via Modbus/TCP



Device dialog

Ethernet		16:14:16
IP address assignment	Automatically (DHCP)	
IP address		
Subnet-Mask		
Standard-Gateway		
DNS device name	MAC000cd8094ecd-TYP706520	
DNS-Server IP automatically	Yes	
DNS-Server		

Parameters

Parameters	Selection/settings	Description
IP address assignment 	Automatic (DHCP) Manual	The device takes its IP address from the DHCP server. The IP address for the device must be assigned manually.
IP address 	0.0.0.0 ... 223.223.223.1 ... 255255255255	Manual allocation of the IP address for the device (active if DHCP = Off) The IP address may need to be requested by the responsible administrator.
Subnet mask 	0.0.0.0 ... 255.255.255.0 ... 255255255255	Manual setting of the subnet mask (active if DHCP = OFF) The structure of the subnet mask may need to be requested by the responsible administrator.

7 Configuration

Parameters	Selection/settings	Description
Standard gateway 	0.0.0.0 ... 255255255255	Manual setting of the IP address of the standard gateway (router) (active if DHCP = OFF) The IP address may need to be requested by the responsible administrator.
DNS device name 	MAC000cd8094ecd-TYP706520 Admissible characters: a ... z, A ... Z, 0 ... 9 (max. 63 characters); Name must start with a letter and must not end with "-" (hyphen).	Example of a unique DNS device name (assigned by default) If necessary, the name can also be assigned individually, but it must be unique.
DNS server IP autom.	Yes No	The IP address of the DNS server is automatically assigned. The IP address of the DNS server must be entered manually.
DNS server 	0.0.0.0 ... 255255255255	IP address of the DNS server (for manual input) The IP address may need to be requested by the administrator in question.



NOTE!

Transfer rate (10 Mbit/s or 100 Mbit/s) and duplex mode (half duplex or full duplex) are determined automatically.



NOTE!

The Ethernet parameters are shown in the device info (Main menu > Device info > Ethernet). In the event of connection problems, check the current settings.

IP address assignment



NOTE!

If applicable, deactivate the DHCP to ensure that the device uses a fixed IP address.

Subnet mask

The subnet mask determines which part of the IP address indicates the network and which part is available for addressing a device within a network. The length of the mask is 32 bits (IPv4), which is the same length as an IP address.

Example: In a network with a mask of 255.255.255.0, the first 24 bits (from the left) are used for the network address; these are set to "1" in the mask. The remaining 8 bits are set to "0" in the mask and can be used for device addresses. There are therefore 254 device addresses available (256 - 2 because the network has assigned itself the address "0" and the address 256 is used for broadcast).

Standard gateway

All network requests to addresses that do not belong to the relevant network are routed through the standard gateway.

DNS device name

The DNS device name is a representative name that can be used for addressing instead of an IP address.

If a DNS device name is entered, it is communicated to the DHCP server so that the device can be addressed with the name entered if the function is supported in the relevant LAN. If no DNS device name is entered, the device can only be addressed using the assigned IP address.



NOTE!

If DHCP is active, a DNS device name should always be used so that the device can also be addressed if the IP address is changed.

DNS server

The DNS server responds to requests from the network seeking to convert a DNS device name into an IP address.

This IP address must be known if the device uses a representative name to address a device or server, for example when sending an email.

7 Configuration

7.23 Serial interface

The device is equipped with a serial interface which is configurable as an RS232 or RS485 interface. The interface supports the Modbus protocol (Modbus RTU) as a master or slave. Alternatively, a barcode scanner may be connected.

For more information on using the serial interface with the Modbus protocol, see:

⇒ Chapter 9.7 "Modbus frames for reading", page 220

⇒ Chapter 9.8 "Modbus frames for writing", page 221

If you use the serial interface with a barcode scanner, please refer to the technical documentation for the barcode scanner for the required settings.

Communication via Modbus is described in detail in the separate interface description.

Device dialog

Parameters

Parameters	Selection/settings	Description
Type	RS232 RS485	RS232 interface RS485 interface
Protocol	Modbus slave Modbus master Barcode	The device acts as a Modbus slave (Modbus RTU) The device acts as a Modbus master (Modbus RTU) A barcode scanner should be operated on the interface.
Baud rate	Baud rate with which the interface is operated.	
	9600 19200 38400 115200	9600 baud 19200 baud 38400 baud 115200 Baud

Parameters	Selection/settings	Description
Data format	Data format with which the interface is operated.	
	8 - 1 - no parity	8 data bits, 1 stop bit, no parity
	8 - 1 - odd parity	8 data bits, 1 stop bit, uneven parity
8 - 1 - even parity	8 data bits, 1 stop bit, even parity	
Min response time	0 to 40 to 500 ms	The minimum response time is adhered to by the Modbus slave before a response is sent following a data request. After receiving a response, the Modbus master waits during this period before sending a new request.

7.23.1 Modbus slave

The device acts as a Modbus slave.



Device dialog

Serial interface
🔒 16:19:09

Baudrate	9600	⬇
Data format	8 - 1 - no parity	⬇
Minimum response time	40 ms	
🏠 Modbus-Slave		
Device address	1	
Timeout monitoring	No	⬇
Alarm-/Event list	Slave-Time-out COM01	
Timeout	2000 ms	
⬇ Modbus-Master		

✕
✓

Parameters

Parameters	Selection/settings	Description
Device address 	1 ... 254	Modbus device address
Timeout monitoring 	No Yes	Monitoring is not active. Monitoring is active.
Alarm/Event text	Use default text or enter other text.	Text that is displayed in the even of an alarm and entered in the alarm and event list.

7 Configuration

Parameters	Selection/settings	Description
Timeout 	250 to 2000 to 99999 ms	Time period for timeout monitoring. After this time, a failure of the Modbus master is identified.

Device address

The device address of the Modbus may only occur once within a connection for the interface type RS485 (multiple devices connected to a bus). This is insignificant for interface type RS232, as only one device can be connected to the serial interface.

Timeout monitoring, timeout







This function monitors the communication between the Modbus master and the Modbus slave from the Modbus slave's point of view. After enabling timeout monitoring, a timer starts when the first request is received (the timer time is the time set as the "Timeout"). With each new request, the timer restarts. If the request fails to arrive, an internal digital signal is enabled after the timer has expired, and an entry is added to the alarm and event list. The signal is reset when the next request arrives.



7.23.2 Modbus master

The device acts as a Modbus master.

Device dialog

Serial interface
 16:20:02

Type	RS 232 
Protocol	Modbus-Master 
Baudrate	9600 
Data format	8 - 1 - no parity 
Minimum response time	40 ms
 Modbus-Slave	
 Modbus-Master	
Timeout	200 ms
Scanning cycle	500 ms

Parameters

Parameters	Selection/settings	Description
Timeout	60 to 200 to 10000 ms	A request sent by the master is defined as faulty if no answer is received within this time.

7 Configuration

Parameters	Selection/settings	Description
Scanning cycle	60 to 500 to 99999 ms	The Modbus master requests the Modbus master data from the Modbus slave at these intervals.

7 Configuration

7.24 Modbus/TCP

This menu is used to implement settings for the Modbus/TCP operating mode.

If the device is a Modbus slave, two external devices (Master 1 and Master 2) can access the device at the same time. If it is a Modbus master, it can communicate with up to four external devices (Device 1 to Device 4).

For use of the Modbus protocol, see also:

⇒ Chapter 9.7 "Modbus frames for reading", page 220

⇒ Chapter 9.8 "Modbus frames for writing", page 221

Communication via Modbus is described in detail in the separate interface description.



NOTE!

To ensure that fixed IP addresses are used, the DHCP must be deactivated in the devices involved, if applicable.



NOTE!

The transfer times in an Ethernet network depend in part on the network architecture and the capacity utilization. This may result in delays during updates of process values.

7.24.1 Modbus slave

The device acts as a Modbus slave.

Device dialog

Modbus-Slave 07:38:50

Port 502

Master 1

Timeout monitoring Yes

IP address 0.0.0.0

Timeout 2000 ms

Alarm-/Event list Slave-Time-out TCP01



Master 2

Cancel OK

Parameters

Parameters	Selection/settings	Description
Port	0 ... 502 ... 1024	TCP port for Modbus/TCP Changes to the port are not applied until after the system has been restarted.

7 Configuration

Parameters	Selection/settings	Description
Master 1, Master 2		
Timeout monitoring 	No Yes	Monitoring is not active. Monitoring is active.
IP address	0.0.0.0	IP address of the Modbus master for timeout monitoring The address must be set.
Timeout 	250 to 2000 to 99999 ms	Time period for timeout monitoring After this time, a failure of the Modbus master is identified.
Alarm/Event text	Use default text or enter other text.	Text that is displayed in the event of an alarm and entered in the alarm and event list.

Timeout monitoring, timeout

This function monitors the communication between the Modbus master and the Modbus slave from the Modbus slave's point of view. After enabling timeout monitoring, a timer starts when the first request is received (the timer time is the time set as the "Timeout"). With each new request, the timer restarts. If the request fails to arrive, an internal digital signal is enabled after the timer has expired, and an entry is added to the alarm and event list. The signal is reset when the next request arrives.

7 Configuration

7.24.2 Modbus master

The device acts as a Modbus master.

Device dialog

Modbus-Master 08:00:13

Timeout: 2000 ms

Scanning cycle: 500 ms

Device 1

IP address: 0.0.0.0

Port: 502

Device 2

Device 3

Device 4

Parameters

Parameters	Selection/settings	Description
Timeout	60 ... 2000 ... 10000 ms	A request sent by the master is defined as faulty if no answer is received within this time.
Scanning cycle	60 ... 500 ... 99999 ms	The Modbus master requests the Modbus master data from the Modbus slave at these intervals.
Device 1 to Device 4		
IP address	0.0.0.0	IP address of Modbus slave The address must be set.
Port	0 ... 502 ... 1024	TCP port of Modbus slave (for Modbus/TCP)

7.25 Time settings

The settings in this dialog are used to synchronize multiple devices by means of a control signal.



NOTE!

The date and time are set in the device parameterization or setup program (online parameters). The PC's date and time are used for the settings in the setup program. The date and time can also be set using a time server.

Device dialog

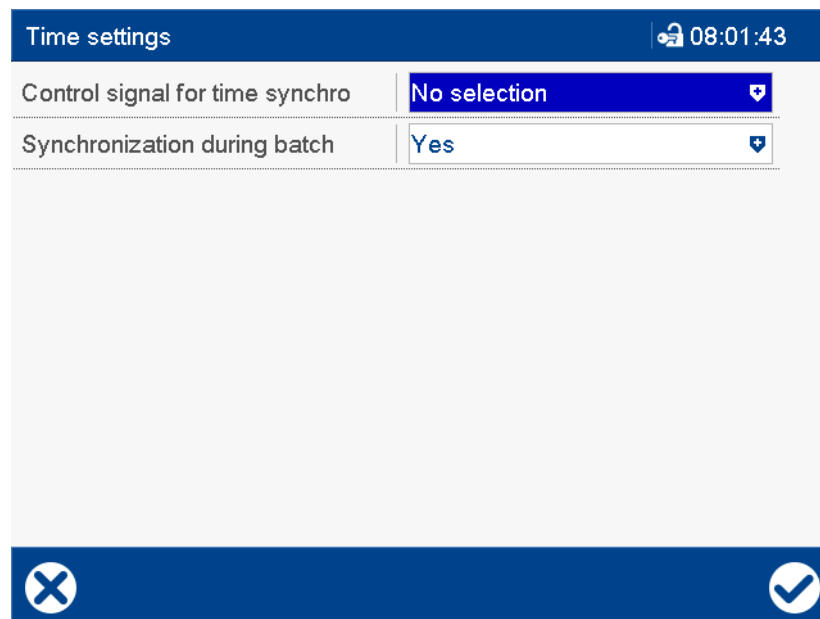

Parameters

Parameters	Selection/settings	Description
Control signal for time sync 	Digital selector No selection	Control signal for synchronizing the time (with low-high edge)
Sync during batch	No, Yes	If "Yes", the time can also be synchronized while batch reporting is in progress.

Control signal for time sync

The signal is used to synchronize multiple devices. The time is synchronized when transferring from Low to High (min. pulse duration = 125 ms). The seconds are crucial to changing the time. The time is put forward or back by a maximum of ±30 seconds. Example:

12:55:29 -> 12:55:00
12:55:30 -> 12:56:00

7 Configuration



NOTE!

In the setup program, the time zone and daylight saving time are also set during the configuration; in the device, they are set in the parameterization (Parameterization > Date and time).

⇒ Chapter 8.4 "Date and time", page 195

7.26 Time server (SNTP)

The time and date of the paperless recorder can be synchronized with a time server using the SNTP protocol (Simple Network Time Protocol).

Device dialog

Time server (SNTP)
🕒 08:03:14

Synchronizing with server	Yes ▼
SNTP-Server 1	<input type="text"/>
SNTP-Server 2	<input type="text"/>
SNTP-Server 3	<input type="text"/>
Period	1 h ▼

✕
✔

Parameters

Parameters	Selection/settings	Description
Synchronize with server	No	Time/date of device are not synchronized.
	Yes	Time/date of device are periodically synchronized with a time server.
SNTP server 📖	The device supports up to three time servers (SNTP). Specify the DNS name if possible and not the IP address.	
1	Enter server address	First time server
2	Enter server address	Second time server
3	Enter server address	Third time server
Period	1 h	Synchronization every hour
	12 h	Synchronization every 12 hours
	24 h	Synchronization every 24 hours

SNTP server

The server list is processed top down, in other words, the next time server on the list is only queried if the previous server is unreachable. If no time server can be reached at the envisaged sync time, synchronization is retried later (the repeat time starts at 1 minute and varies). After five unsuccessful attempts, a "Time server error" message is added to the event list. After a wait, another attempt is made to synchronize the time.

7 Configuration

Time zone and daylight saving time

The SNTP server always provides the UTC time so that both the time zone and the time for switching to daylight saving time are only defined by the device configuration (Configuration > Date and time).

Deviation tolerance

Time and date synchronization depends on the deviation tolerance (30 s).

If the deviation of the time/date between the server and the device is less than or equal to the deviation tolerance, the time on the device is slowly modified (the internal clock runs slightly faster or slower) without needing reconfiguration. This also applies in the special cases stated below. If the deviation of the time/date between the server and the device is greater than the deviation tolerance, a new configuration is automatically generated, and the time/date on the device are immediately set to the new value from the server (time jump). However, this does not apply in the following special cases:

- Batch reporting is active
- Setup transmission is active
- Transmission of measurement data by the PCC program is active
- Control windows are open on the device (e.g., configuration)
- Memory manager is active (e.g., writing data to the USB flash drive)

In the stated special cases, time synchronization is canceled and another attempt is made after 1 minute. In the event of further unsuccessful attempts, the repetition interval is varied slightly to avoid the time query occurring at the same interval as the other event preventing time synchronization (e.g., PCC transmission).

7.27 Undocumented parameters



CAUTION!

Incorrect configuration of the "undocumented parameters".

The system does not react as it should.

Undocumented parameters must only be changed if the user is requested to do so by a service technician from the manufacturer.

8 Parameterization

This chapter describes the parameterization of the paperless recorder; this is only possible on the device: **MAIN MENU > PARAMETERIZATION**

If a parameter is also configurable in the setup program or via Modbus, this will be mentioned.



NOTE!

Parameterization in the device is only available if a user is logged on, and the user has the required rights.

Default settings are shown in **bold** in the parameter tables.

8.1 Fine adjustment

You can use customer-specific fine adjustment to correct the measured values of the analog input. In contrast to offsetting, which is used to specify a constant correction value for the entire characteristic line, fine adjustment can also be used to change the gradient of the characteristic line.

Device dialog

Parameters

Parameters	Selection/settings	Description
Active	Yes	The function for performing fine adjustment is active.
	No	Function is inactive.
Actual start value	-99999 ... 0 ... +99999	Lower display value
Actual end value	-99999 ... 1 ... +99999	Upper display value
Target start value	-99999 ... 0 ... +99999	Lower reference value
Target end value	-99999 ... 1 ... +99999	Upper reference value

8 Parameterization

Example

The temperature inside a furnace is measured with an RTD temperature probe and displayed. Due to the temperature drift of the probe, the true temperature (reference measurement) deviates from the displayed value. The amount of deviation is different at the upper and lower measuring points, meaning that measured value offset is not suitable.

Actual start value: 15 °C (displayed value)

Target start value: 20 °C (reference measurement)

Actual end value: 70 °C (displayed value)

Target end value: 80 °C (reference measurement)

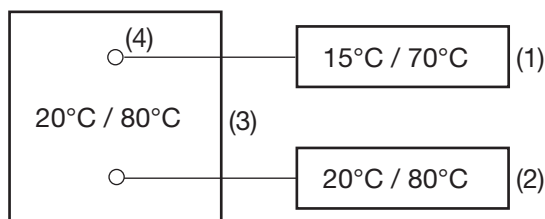

(1) Display values

(2) Reference values

(3) Furnace

(4) Sensor in RTD temperature probe

Performing fine adjustment

1) Determine the lower value (as low and constant as possible) with the reference measuring device.

Example: Set furnace temperature to 20 °C.

2) Enter the display value as the actual start value and the reference value as the target start value.

Example: Enter 15 and 20.

3) Determine the upper value (as high and constant as possible) with the reference measuring device.

Example: Increase furnace temperature to 80 °C.

4) Enter the display value as the actual end value and the reference value as the target end value.

Example: Enter 70 and 80.

Characteristic line

The following diagram shows the changes in the characteristic line caused by the fine adjustment (point of intersection with the x axis as well as the gradient).

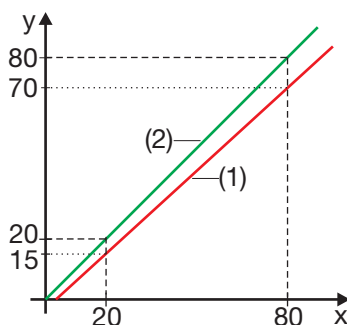

y Display value

(1) Characteristic line before fine adjustment

x Reference value

(2) Characteristic line after fine adjustment

Resetting the fine adjustment

The following settings must be made to reverse the fine adjustment:

Actual start value = target start value

Actual end value = target end value

8.2 Counters/Integrators

This function is used to change the current counter/integrator status (e.g., to 0 or any other value). The counter/integrator continues to run with this new value, but the period for adding the total is not restarted.

The change is logged in the event list specifying the old and new values and is only effective once. The old value is not stored.

Device dialog

Counter/Integrator 1 🔒 13:28:31	
Current value	+0.000000000
Start value	+0.000000000

Parameters

Parameters	Selection/settings	Description
Current value	(Display only)	Displays the current counter/integrator status
Start value	-999999999 to 0 to +999999999	New start value for the counter/integrator

8 Parameterization

8.3 Limit value monitoring functions

As of device version 02 limit value and switching differential in the general limit value monitoring functions are also adjustable in the parameterization. The prerequisite here is that limit value monitoring has been previously configured.

⇒ Chapter 7.14 "Limit value monitoring", page 130

Limit value and switching differential can be configured in the configuration as well as via Modbus.

Device dialog

Limit value monitoring 1
🔒 16:07:34

Channel designation	LM 01
Channel description	Lim. val. monitor. 01
Signal source	Analog input 1
🔒 Alarm	
Limit value	<input style="width: 80%;" type="text" value="+0.0000 °C"/>
Switching differential	<input style="width: 80%;" type="text" value="+0.0000 °C"/>

✕
✓

Parameters

Parameters	Selection/settings	Description
Channel description	None	Name (brief description), as configured.
Channel description	None	Description (description), as configured.
Signal source	None	Input signal of limit value monitoring (signal to be monitored), as configured.
Limit value	-99999 to 0 to +99999	If the limit value is exceeded (max. alarm case) or the value drops below the limit (min. alarm case), an out-of-limit case exists.
Switching differential	0 to 99999	The switching differential is used to suppress constant switching of the status signal in the event of fluctuations of the input signal around the limit value.

8 Parameterization

Parameters	Selection/settings	Description
Start of daylight saving time	January to March to December First, second, third, fourth, last Sunday to Saturday, 1 to 31 00:00 to 02:00 to 24:00	Month Weekday in month Weekday/day Time
End of daylight saving time	January to October to December First, second, third, fourth, last Sunday to Saturday, 1 to 31 00:00 to 03:00 to 24:00	Month Weekday in month Weekday/day Time



NOTE!

In the setup program, the time zone, and daylight saving time are set during the configuration (Configuration level > Date and time).



NOTE!

Any change in the date and time will lead to a new configuration.

8.5 Batch

This function assigns a default start number for the batch number.

The batch number is used in the batch report. At the end of batch reporting, the value is incremented by one.

Device dialog

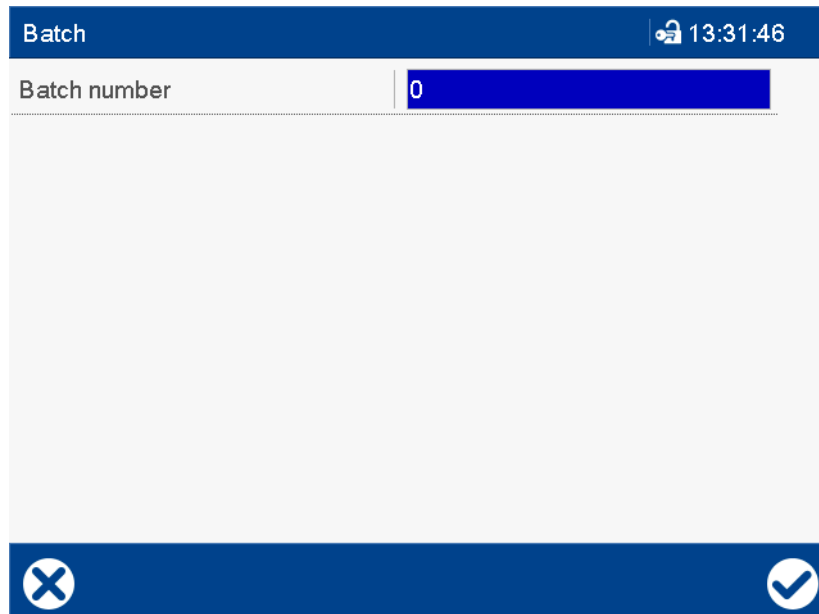

Parameters

Parameters	Selection/settings	Description
Batch number	0 to 999999999	Start number for batch number

8 Parameterization

8.6 System data

The "Country settings after power on" parameter determines whether the language and other country-specific settings (temperature unit, time zone, daylight saving time) can be selected when the device is next powered on.

This parameter can also be set in the configuration, but only with the setup program.

⇒ Chapter 7.4 "Device", page 94

As of device version 02 this menu also includes the "Transfer users separately" parameter.

Device dialog

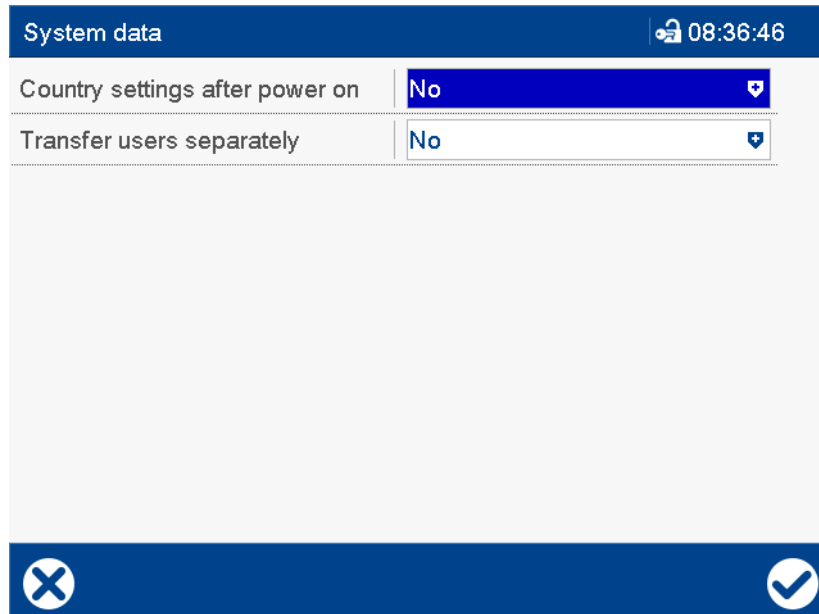

Parameters

Parameters	Selection/settings	Description
Country settings after power on	Yes, No	If "Yes," is selected, the user can configure settings immediately after switching on the device the next time. The parameter is then automatically reset to "No" so that no settings occur after switching back on again. The country settings are also configured after switching on the device for the first time as part of the startup.
Transfer users separately (as of device version 02)	Yes, No	Only for a device without extra code 888 (FDA): If choosing "Yes" the user table (table with user ID and name, password, group assignment) will not be transferred along with the configuration and the user groups to the device. In that case the user table can only be transferred separately. ⇒ Chapter 6.3.6 "Window", page 83, User list

9 Configuration – in setup program only



NOTE!

The functions described in this chapter can only be configured with the setup program.

Default settings are shown in **bold** in the parameter tables.

9.1 Country settings

Text library

The text library is used to manage the various language and country-specific settings, such as the date format and decimal point, independently of the project.

Function in the menu bar: **TOOLS > TEXT LIBRARY**

This function is only available if a license number that includes text library editing has been registered.

Country settings

The country settings (language and country-specific settings such as the date format and decimal point) are taken from the text library by the setup program when creating a setup file. The first two languages (Language 1 and Language 2) are applied. The user can add more languages.

A country setting can be moved to another position in the list ("Sort language"). The first 15 country settings in the list are sent to the device and are available there for changing the language.



NOTE!

Language can be edited both in the text library and in the country settings. As a general rule, all country- or customer-specific changes should be made in the text library while project-specific modifications are made in the country settings.

Setup dialog

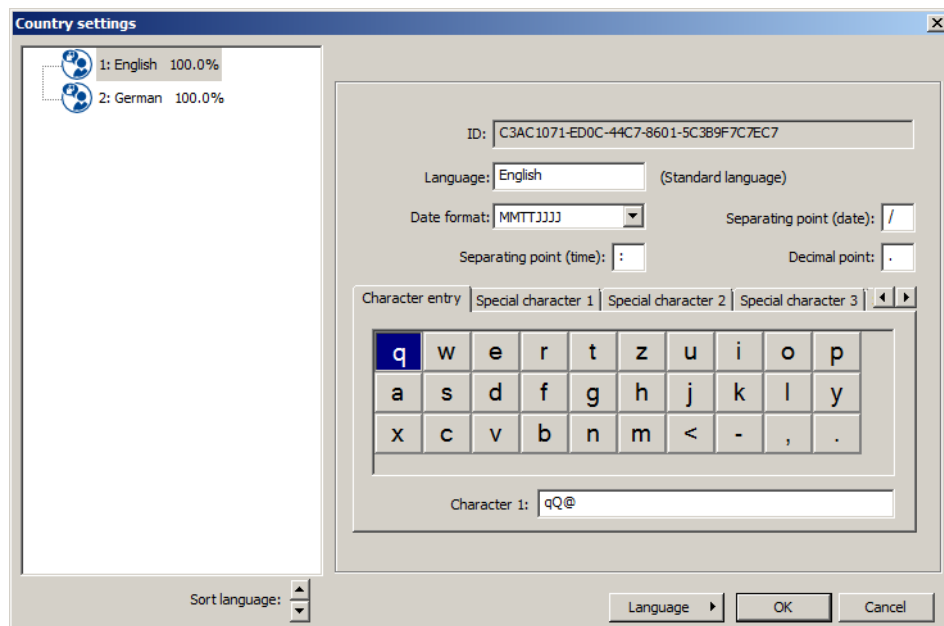

9 Configuration – in setup program only

Parameters

Parameters	Selection/settings	Description
ID	(No input box)	Internal ID (only for service purposes to identify the language)
Language	Use default text or enter other text.	Description of the language
Date format	DDMMYYYY MMDDYYYY YYYYMMDD	Example: 31.12.2010 Example: 12-31-2010 Example: 2010-12-31
Separating point (time)	Use the default character or enter another character.	Example of separating point ":" (colon): 23:59:59
Separating point (date)	Use the default character or enter another character.	Example of separating point "/" (slash): 31/12/2010
Decimal point	Use the default character or enter another character.	Example of decimal point "." (point): 100.5
Character input (entry) (standard keyboard layout), Special character 1 to Special character 5	Keyboard layout of virtual keyboard on the device (letters, digits, and non-standard characters) In the default keyboard layout each key can be assigned up to 10 characters. In the other keyboard layouts (Non-standard character 1 to 5), only one character per key is possible.	
	Left click the virtual key in the keyboard field. If needed, change the key assignments in the text box (below the keyboard box).	The relevant key is selected and the characters that are assigned to the key appear in the text field. The first character on the left corresponds to the character on the key.

Language

After pressing the **LANGUAGE** button, the user has various editing options:



For example, the user can edit a language or create a new language based on an existing language.

Language editing functions

Selection	Submenu	Function
New language ...	Create	A new language is created based on the selected language.
New language ...	From setup file	The new language is created from an existing setup file. To do this, the user needs to select the setup file from a directory (file with a suffix of ".323"). If the setup file contains multiple languages, these languages are shown for selection.

9 Configuration – in setup program only

Selection	Submenu	Function
New language ...	From present library	The new language is created from the text library of the current setup program. If the text library contains multiple languages, the user needs to select the desired language.
New language ...	From another library	The new language is created from another text library. To do this, the user needs to select the text library file from a directory (file with the suffix ".dat"). If the setup file contains multiple languages, these languages are shown for selection.
Edit		Opens the "Device texts" window in which the (target) language can be edited.
Delete		Deletes the selected language.
Copy		Copies the selected language.

9 Configuration – in setup program only

9.2 User list

The user IDs, names, and passwords for various users are assigned in the user list, and the user rights are managed. The system supports up to five users with varying rights.

These settings are crucial for logging onto the device. They are not crucial for logging onto the setup program.

Additionally, public rights are defined here. These rights are used if there is no user logged onto the device.



NOTE!

As of device version 02: in a device without extra code 888 (FDA), the "Transfer users separately" parameter decides whether the user table (user id and name, password, group assignment) will be transferred separately from the configuration and the user groups to the device.

See chapter "Parameterization" > "System data".



NOTE!

As of device version 02: a device with extra code 888 (FDA) does not have this function available in the setup program because the user list can only be created with the PC Security Manager software PCS. Up to 50 users can be administered like that; the "Administer users" right is required here. See operating manual for PC security manager software PCS (B 709703.0 or 70970300T96...).

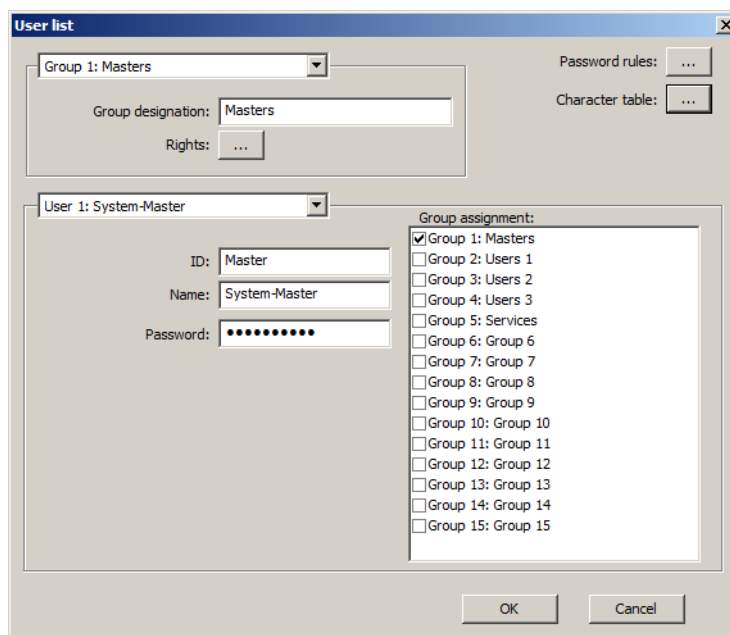

Setup dialog



Parameters

Parameters	Selection/settings	Description
Password rules	Select the button	⇒ Chapter 9.2.2 "Password rules", page 204
Character table	Select the button	⇒ Chapter 9.2.3 "Character table", page 205

9 Configuration – in setup program only

Parameters	Selection/settings	Description
Group 1 ... Group 15, Public rights 	Select relevant user group from the drop-down list.	The following parameters "Group ID" and "Rights" refer to the selected user group. The rights for users that are not logged on are defined by selecting "Public rights".
Group designation	Use the default designation or enter a different designation.	Use a text that describes the function (rights) of the user group.
Rights	Select the button	Rights of the user group ⇒ Chapter 9.2.5 "Rights (user rights)", page 207
User 1 ... User 5 	Select relevant user from the drop-down list.	The default settings for the relevant user are displayed and can be changed by the operator. ⇒ Chapter 9.2.1 "Default user settings", page 204
ID	Use default ID or enter other ID.	The ID (user ID) is displayed in the user list for logon.
Name	Use default name or enter other name.	Use a text for the name that describes the function (rights) of the user. The name is not displayed or requested for logon time.
Password	Use the default password or enter a different password.	The password is requested for logon.
Group assignment	Select one or several user groups (select checkbox).	The relevant user gets the rights of the selected user group.

Group 1Group 15, Public rights

Up to 15 groups are provided for assigning user rights; specific rights are assigned to these groups. An individual name can be assigned to each group in order to make it easier to distinguish the groups (e. g. "Master", "Users", "Service"). The rights assigned to the group "Public rights" are valid for users who are not logged on.

User 1 ... User 5

Up to 5 users can be managed, each user can be assigned to one or multiple groups. As a result, the user receives the rights of the relevant group.

9 Configuration – in setup program only

9.2.1 Default user settings

User 1 (Master) is assigned all rights by default. Users 2 to 4 (User 1 to User 3) and User 5 (Service) have limited rights.

User 5 is designed for performing service functions. It differs from User 1 in that the user cannot manage any other users or delete recorded data. Users 2 to 4 have identical rights.

Users 1 to 5 are designed both for logging on directly to the device and for logging on indirectly to the device via the setup program.

The individual rights of each user can be configured individually with the setup program.

The following IDs, names, and passwords are set by default:

Users	ID	Name	Password
User 1	Master	System Master	9200
User 2	User 1	Data Management	1
User 3	User 2	Data Management	2
User 4	User 3	Data Management	3
User 5	Service	Service	9200

9.2.2 Password rules

Re-authentication guarantees that a user has to log on to the device again after a specified time has elapsed during which no operation is performed. The device can be protected against unauthorized users in this way.

The user is not logged out immediately after the time elapses, and only when the next operation is performed. A message then appears prompting the user to log on again. After confirming this message by pressing "OK," the user can log back on.

If the device is in a condition in which operation is not possible (e.g., during a configuration), the timer is stopped.

Setup dialog

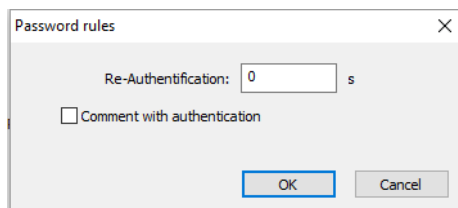

Parameters

Parameters	Selection/settings	Description
Re-authentication	0 to 65535	Time after which it is necessary to log on again. 0 = Function is disabled
Comment with authentication (as of device version 02) 	Yes (<input type="checkbox"/>) , No (<input checked="" type="checkbox"/>)	By choosing "Yes" the user has to select a user ID and enter the password to enter a comment text. The comment text is entered into the event list along with the user ID.

9 Configuration – in setup program only

Comment with authentication

A comment with authentication can be performed by any user who has the appropriate authorization ("View recording data and evaluate history" right). This can be another user than the one who is currently logged on.

9.2.3 Character table

The character table is used to define the characters available for assigning passwords.

The characters are displayed on the device in the form of a virtual keyboard, which is organized in levels.

If the setup program is used to assign or change a password, only the characters specified in the setup program are admissible. Subdivision into levels is irrelevant in this case.

Setup dialog



Parameters

Parameters	Selection/settings	Description
Character 1 ... Character 16 (Character level)	Select level from the drop-down list. The default levels 1 to 4 cannot be edited. Other levels can be added in a user-specific way.	Virtual keyboard level for assigning the password on the device The virtual keyboard can consist of up to 16 levels, each with up to 32 characters.
Heading	Use the default text or enter a different text.	Short description for the level of the device's virtual keyboard (not currently used).
Category	Select relevant category from the drop-down list (if necessary).	The category enables you to distinguish levels according to the type of characters defined there.
Input box (bottom)	Enter or edit characters	The characters are displayed in the keyboard field in the order of entry (from left to right and top down). The view basically reflects the virtual keyboard of the device.

9 Configuration – in setup program only

9.2.4 Public rights

Public rights apply to users who are not logged on to the system.

Setup dialog

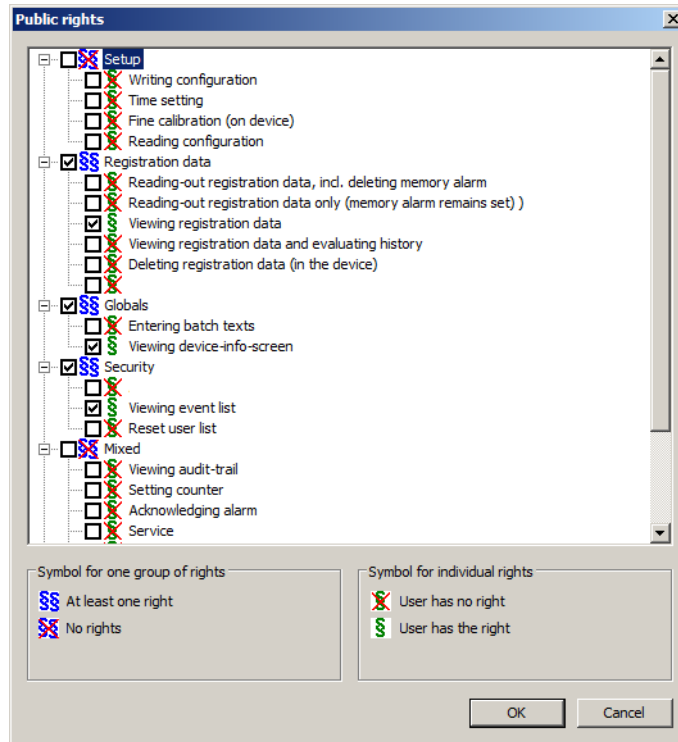

Assign rights

The rights are listed as a tree structure. A click on "+" expands the view: the relevant sub-items (single rights) become visible. A click on "-" collapses the view: only the main item (group) is visible.

The rights are activated by a click on the corresponding checkbox.

9 Configuration – in setup program only

9.2.5 Rights (user rights)

User rights apply to a user logged onto the device.

Setup dialog

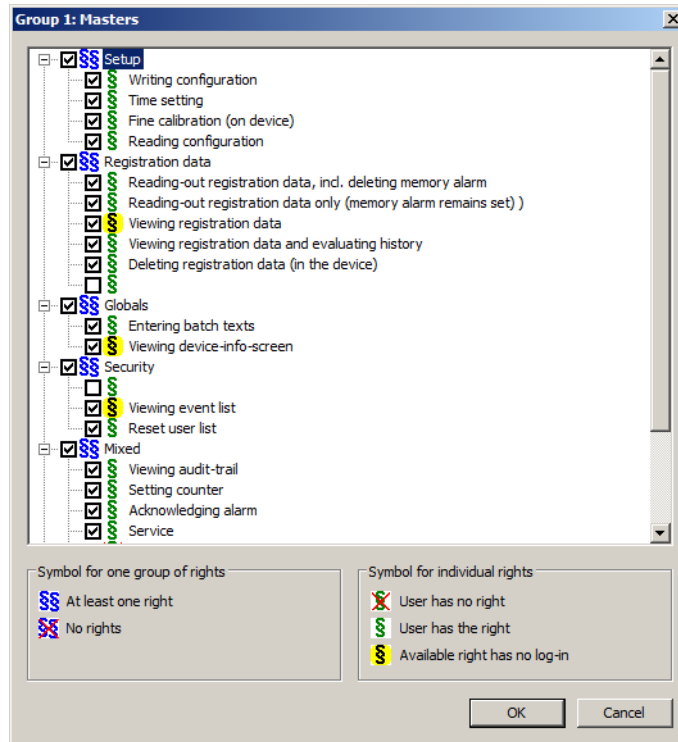

Assign rights

The rights are listed as a tree structure. A click on "+" expands the view: The relevant sub-items (single rights) become visible. A click on "-" collapses the view: only the main item (group) is visible.

The rights are activated by a click on the corresponding checkbox.

9 Configuration – in setup program only

9.2.6 Overview of rights

The following rights can be assigned as public rights and user rights.

Category	Individual right
Setup	Write configuration
	Time setting
	Fine calibration (fine adjustment, on the device)
	Read configuration
Recording data	Read out recording data, incl. clear memory alarm
	Read out recording data only (memory alarm is kept)
	View recording data
	View recording data and evaluate history
	Delete recording data
	Create device certificate (as of device version 02)
Globals	Enter batch texts
	View device info screen
Security	Administer users
	View event list
	Reset user list
Mixed	View audit trail
	Set counter
	Acknowledge alarm
	Service
	Logon only via setup program
Extra codes	Release (activate) extra codes
Process screen (as of device version 02)	Process screen operation
Parameterization	Write parameterization
	Read parameterization
Batches (only in PCS; as of device version 02)	Confirm batches, electronic signature (on the device)

9 Configuration – in setup program only

Effects of rights (on the device)

Individual right	Effect
Write configuration	<p>The configuration can be written (edited) and read (only writing is possible in the setup software).</p> <p>The menu items or functions are available in the individual menus (Main menu: Configuration; Sub-menu "Service": Load default configuration; Flash manager: Read configuration from USB flash drive, software update).</p>
Time setting	<p>In the main menu, "Parameterization" sub-menu, the menu item "Date and time" (for setting the date, time, time zone, and daylight saving time) is available.</p> <p>The date and time can also be set with the setup program (Online parameters; use of PC date and time of PC).</p>
Fine calibration (fine adjustment, on the device)	<p>The "Fine adjustment" (fine adjustment of analog inputs) menu item is available in the main menu, "Parameterization" sub-menu.</p>
Read configuration	<p>The configuration can be read.</p> <p>The menu items or functions are available in the individual menus (Main menu: Configuration; Sub-menu "Service": Save default configuration; Flash manager: Write configuration to USB flash drive, software update).</p>
Read out recording data, incl. clear memory alarm	<p>The following functions are available in the Flash Manager: Writing recording data to USB flash drive; Write current counters/statistics and recording data to USB flash drive.</p>
Read out recording data only (memory alarm is kept)	<p>The following function is available in the Flash Manager: Saving all recording data on USB flash drive (Backup). – The memory alarm is cleared.</p> <p>If the recorded data is read out with the PCA communication software PCC, the following applies:</p> <p>If the user logged onto PCC only has this right, but not the right "Read out recorded data, incl. delete memory alarm", the user can only extract the data, but not clear the memory alarm.</p> <p>To also clear the memory alarm, the appropriate option must be active in PCC (Do not delete memory alarm on device: No).</p>
View recording data	<p>All views are available in the Visualization menu (View) (incl. batch report).</p>
View recording data and evaluate history	<p>All views are available in the Visualization menu (View) (incl. batch report). In the curve diagram and the digital diagram, the memory display (history) can be called up. It is possible to enter a comment text. The curve presentation can be opened in the report for the completed batch.</p>
Delete recording data	<p>All recorded data can be deleted (function in setup program, online parameters).</p>
Create device certificate	<p>A device certificate can be created (function in setup program, online parameters).</p>
Enter batch texts	<p>All views are available in the Visualization menu (View) (incl. batch report). The batch texts can be edited in the current batch report.</p>
View device info screen	<p>The Device info menu is available in the main menu (it contains information about the device, the current process values, and the Ethernet interface).</p>
Administer users	<p>The Flash manager has the following function available: read user list from USB flash drive.</p>
View event list	<p>The event list is also available in the alarm and event menu.</p>

9 Configuration – in setup program only

Individual right	Effect
Reset user list	The user list can be reset (function in setup program, online parameters).
View audit trail	The "Audit Trail list" menu item is available in the main menu (the list contains all audit trail messages).
Set counter	The menu items "Counters/Integrators" (set initial value) and "Batch" (enter batch number) are available in the main menu, "Parameterization" sub-menu.
Acknowledge alarm	The collective alarm can be acknowledged in the alarm list.
Service	The "Service" menu item is available in the main menu. The "Writing service data to USB flash drive" function is available in the Flash Manager.
Logon only via setup program	The user can only log onto the device through the setup program; the user cannot be selected in the device itself.
Activate extra codes	Extra codes can be activated (function in setup program, online parameters).
Process screen operation	In the process screen, in case of an input object a value or text can be entered (in as far as the object is editable).
Write parameterization	The "Parameterization" menu item is available in the main menu; the sub-menu parameters can be edited.
Read parameterization	The "Parameterization" menu item is available in the main menu; the system data can be read.
Confirm batches, electronic signature (on the device)	The user can provide the electronic signature for a completed batch, for the recording data of a certain time period, or when logging off (in as far as the PCS is configured appropriately).

9.2.7 Behavior after power on

The user needs to log on whenever the device is powered on.
Changes to the user list are stored on powering off.

9.2.8 Expertise protection

The device configuration typically contains the user's specific expertise, which needs to be protected against unauthorized access.

The device provides multiple rights which are configurable depending on the requirements and which provide protection of expertise:

- The right "Read configuration" along with the right "Write configuration" (both rights are disabled) prevents the configuration being visible on the device.
- The right "Read configuration" (right disabled) prevents copying to a USB flash drive and reading out data with the setup program.
- The "Manage users" right (right disabled) lets you prevent expertise protection being disabled.
- The right "Reset user list" (right disabled) prevents working around expertise protection.
- The "Logon via setup program only" right (enabled) gives the plant manufacturer the ability, in combination with the rights "Write configuration" and "Read configuration," to ensure that the end user on the device cannot view the configuration.

9 Configuration – in setup program only

9.3 Batch text

A batch text is used when configuring the batch info, either via direct selection from the text list or as the result of binary linking.

128 texts are available in each of the up to 15 device languages; these can be edited individually in this menu.

Setup dialog

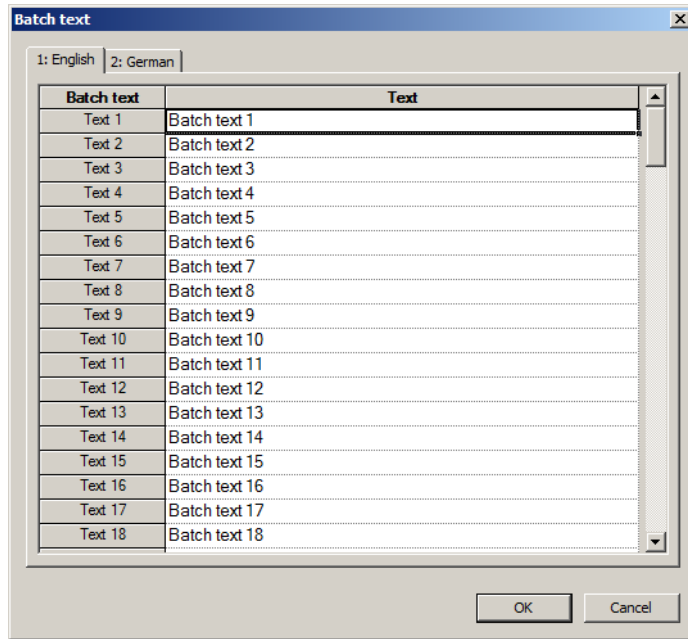

Parameters

Parameters	Selection/settings	Description
Batch text	Select the relevant device language (tab) and edit the text to be changed in the "Text" column (max. 160 characters).	Text that is available in the text list for the configuration of the batch info.

9 Configuration – in setup program only

9.4 Email

An email alarm can be sent to up to three address simultaneously via a mail server. Up to 5 alarm texts can be configured; sending is controlled using a digital signal.

Setup dialog

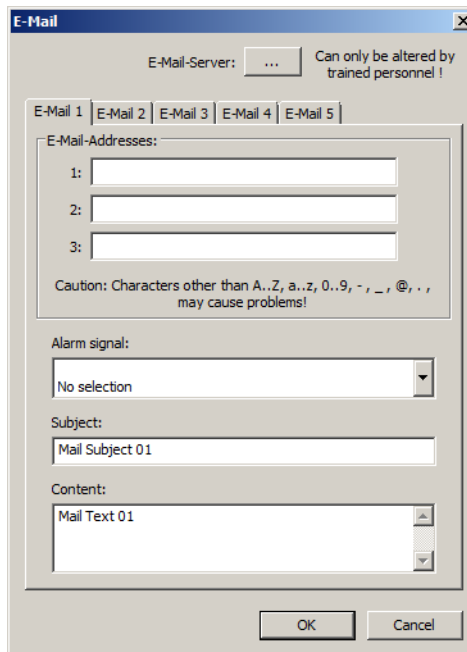

Parameters

Parameters	Selection/settings	Description
Email 1 ... Email 5 (Email settings for the 5 alarm texts)		
Email addresses	The email is sent to up to 3 email addresses (each with max. 64 characters) at the same time.	
	1	Enter first email address
	2	Enter second email address
	3	Enter third email address
Alarm signal	Signal that triggers sending of an email.	
	No selection Digital signal	No alarm message Alarm message is triggered by a signal (high active), which must be selected from the list of digital signals (digital selector).
Subject	Text (max. 120 characters) for the subject line of the email	
	Mail Subject 01 (For email 1)	Use or edit text from list
Content	Text (max. 120 characters) for the text field of the e-mail	
	Mail Text 01 (For email 1)	Use or edit text from list

9 Configuration – in setup program only



NOTE!

Email sending should be tested in the course of startup. If there is an error, this leads to an entry with an error code in the device's event list. The interface description contains a list of all error codes ("Error codes as integer return values").

9.4.1 Email server



NOTE!

The following settings may only be performed by qualified personnel.

Setup dialog

Parameters

Parameters	Selection/settings	Description
Authentication	Authentication at logon to email server	
	None SMTP-Auth	No authentication Authentication with user name and password on SMTP server
User name	User name (max. 64 characters) for logging on to the email server	
	Your user name (Example)	Enter name (also applies if Authentication = no)
Password	Password (max. 64 characters) for logging on to the email server	
	Your password (Example)	Enter password (only for SMTP Auth)
SMTP server	Address (URL, max. 64 characters) of the email server for SMTP	
	smtp.example.net (Example)	Enter server address
Sender (email address)	Email address (max. 64 characters) as sender address	
	device@example.net (Example)	Enter address

9 Configuration – in setup program only



NOTE!

Email transmission between the device and server is unencrypted (SMTP: port 25). Email sending is only possible if the email provider supports unencrypted transmission; if needed, select a different provider.

9 Configuration – in setup program only

9.5 Web server

The integrated web server provides the user with convenient access via LAN to process values, various visualizations, and the device's alarm and event list from a web browser. Access can be password protected.

The device has a maximum of 2 MB memory for HTML pages. The start page, index.htm, is available by default; to access a web browser, enter the device's IP address. If needed, you can also use the DNS device name.



NOTE!

The Microsoft® Silverlight® plug-in¹ is required for this function. If the plug-in is not available, the web browser displays a message and offers to install it.

Supported web browsers: Microsoft® Internet Explorer¹, Mozilla Firefox²

¹ Microsoft®, Silverlight®, and Internet Explorer are registered trademarks of Microsoft® Corporation.

² Mozilla and Firefox are registered trademarks of Mozilla Foundation.

Setup dialog

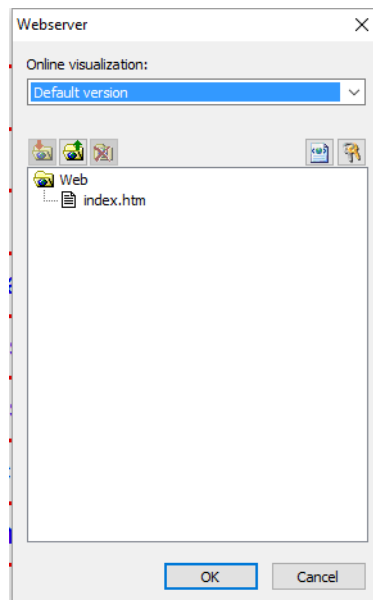

Online visualization

As of device version 02 the online visualization is configurable as default version or user version.







In the **Default version** a distinction is made between a standard device and an FDA device (extra code 888):

- Standard device (version: standard): all functions are available.
- FDA device (version: 21 CFR Part 11): the "Import" and "Delete" functions are locked; the FDA compliant web application that is created by the manufacturer is always transferred to the device. Only data is displayed in the web browser; entering comments is not possible.

The **User version** does not include a default web application. Creation and use of the web application are the customer's responsibility. All functions are available.

9 Configuration – in setup program only

Function of buttons

Button	Description	Description
	Import Web	Select the folder that contains the files required for the Web application (incl. HTML files).
	Export Web	Select the folder to which the files used for the Web application should be exported.
	Delete Web	After answering the security request, all files (except index.htm) are removed from the setup file.
	HTML tags 	HTML tags are used to convert names of variables into addresses for Web server programming.
	Security 	The user name and password for logging on and the time until the next automatic logoff are defined here.

HTML tags

To open this window, use the "HTML tags" button:

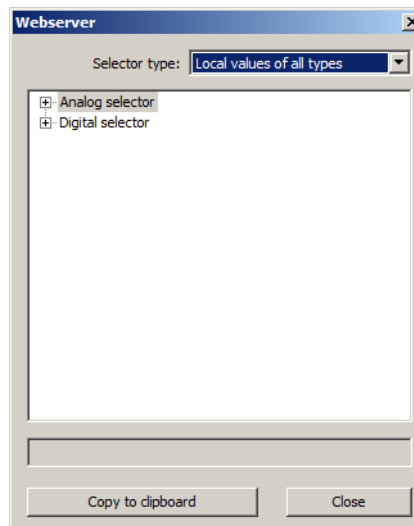

Select the required variable names from the relevant selectors.

Security

To open this window, use the "Security" button:

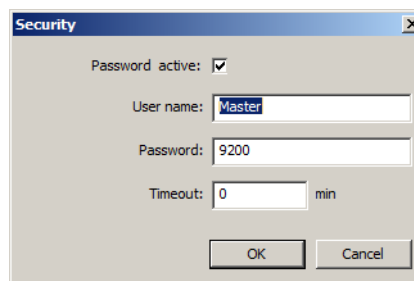

9 Configuration – in setup program only

Parameters

Parameters	Selection/settings	Description
Password active	Yes (<input checked="" type="checkbox"/>) , No (<input type="checkbox"/>)	If "Yes," the user needs to log on with their user name and password to be able to access the website. No logon is required for "No".
User name	Master (ASCII; max. 31 characters)	User name for logon to the Web server
Password	9200 (ASCII; max. 31 characters)	Password for logging onto the web server
Timeout	0 ... 1092 min	Time until automatic logout if no user activity is detected. 0 min = No automatic logout

9 Configuration – in setup program only

9.6 Electronic signature

This menu point is included as of device version 02 if extra code 888 (FDA) is available. These settings are significant for the appearance and text entry during an electronic signature. If an electronic signature can even be provided – or whether it must be provided – depends on the configuration in the PC Security Manager software PCS. See operating manual for PC Security Manager software PCS.

Setup dialog

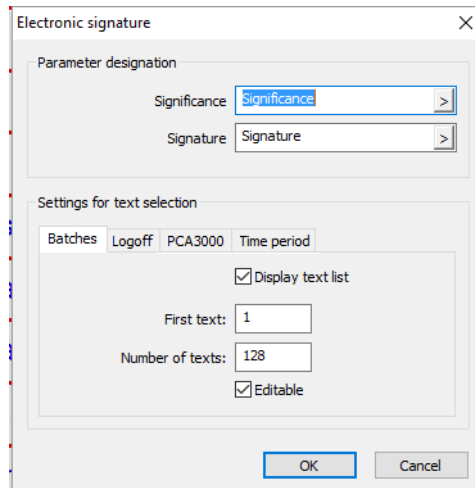

Parameters

Parameters	Selection/settings	Description
Description of the parameters		
Meaning	Enter text (or use default text).	Description of the parameter in the device The text that is entered here is used as heading or row description in the respective device dialog box. During the electronic signature an evaluation text that describes the meaning of the signature (for what is being signed) can be entered.
Signature	Enter text (or use default text).	Description of the parameter in the device The text that is entered here is used as heading or row description in the respective device dialog box.

9 Configuration – in setup program only

Parameters	Selection/settings	Description
<p>Settings for text selection</p> <p>The following parameters decide whether an evaluation text that describes the meaning of the signature (e.g. "Batch o.k.") can be used for an electronic signature.</p> <p>The parameters need to be set separately for the following applications:</p> <ul style="list-style-type: none"> • Batches: signature for completed batches • Logoff: signature when logging off • PCA3000: subsequent signature for a completed batch in the PC evaluation software PCA3000 • Time period: signature for a certain time period 		
Display text list	Yes (<input checked="" type="checkbox"/>) , No (<input type="checkbox"/>)	By selecting "Yes" the evaluation text (meaning) can be selected from the text list (batch text).
First text	1 to 128	First text that is selectable from a text list of up to 128 texts.
Number of texts	1 to 128	Number of selectable texts (as of the first text)
Editable	Yes (<input checked="" type="checkbox"/>) , No (<input type="checkbox"/>)	<p>By selecting "Yes" any text can be entered or – when displaying text list = "Yes" – the text can be edited in the text list.</p> <p>By selecting "No" and displaying text list = "No" the result is the signature without evaluation text.</p>

9 Configuration – in setup program only

9.7 Modbus frames for reading

This function is used to compile up to 32 Modbus frames for reading process values from external devices (via interface) individually for each opposite end. The process values (analog and digital values, texts) are written to the selected variables (external inputs and texts) from the received Modbus telegram and are available for use with the paperless recorder.

Each frame can be used to configure up to 24 frame entries with a process value each, which are then grouped and transmitted in a Modbus telegram.

Setup dialog

Frame entry	External input	Modb.add...	Modb.add...	Data type	Bit posi...	Facto
Frame entry 1	Process values\No selection	0x0000	0x8000	None	-	-
Frame entry 2	Process values\No selection	0x0000	0x8000	None	-	-
Frame entry 3	Process values\No selection	0x0000	0x8000	None	-	-
Frame entry 4	Process values\No selection	0x0000	0x8000	None	-	-
Frame entry 5	Process values\No selection	0x0000	0x8000	None	-	-
Frame entry 6	Process values\No selection	0x0000	0x8000	None	-	-
Frame entry 7	Process values\No selection	0x0000	0x8000	None	-	-
Frame entry 8	Process values\No selection	0x0000	0x8000	None	-	-
Frame entry 9	Process values\No selection	0x0000	0x8000	None	-	-
Frame entry 10	Process values\No selection	0x0000	0x8000	None	-	-
Frame entry 11	Process values\No selection	0x0000	0x8000	None	-	-
Frame entry 12	Process values\No selection	0x0000	0x8000	None	-	-
Frame entry 13	Process values\No selection	0x0000	0x8000	None	-	-
Frame entry 14	Process values\No selection	0x0000	0x8000	None	-	-
Frame entry 15	Process values\No selection	0x0000	0x8000	None	-	-
Frame entry 16	Process values\No selection	0x0000	0x8000	None	-	-



CAUTION!

A variable can be used in multiple frames. This means that different process values are written to the same variable. You must ensure that no variables are overwritten unintentionally.

Configuration and use of the Modbus frames for reading is described in the interface description.

⇒ Chapter 1.4.2 "Device documentation in the form of PDF files", page 16

9 Configuration – in setup program only

9.8 Modbus frames for writing

This function can be used to compile up to 32 Modbus frames for writing the paperless recorder's process values to external devices (via interface) individually for each opposite end. The paperless recorder writes the process values (analog and digital values; texts) to the frames, where they are available for external devices.

Each frame can be used to configure up to 24 frame entries with a process value each, which are then grouped and transmitted in a Modbus telegram.

Setup dialog

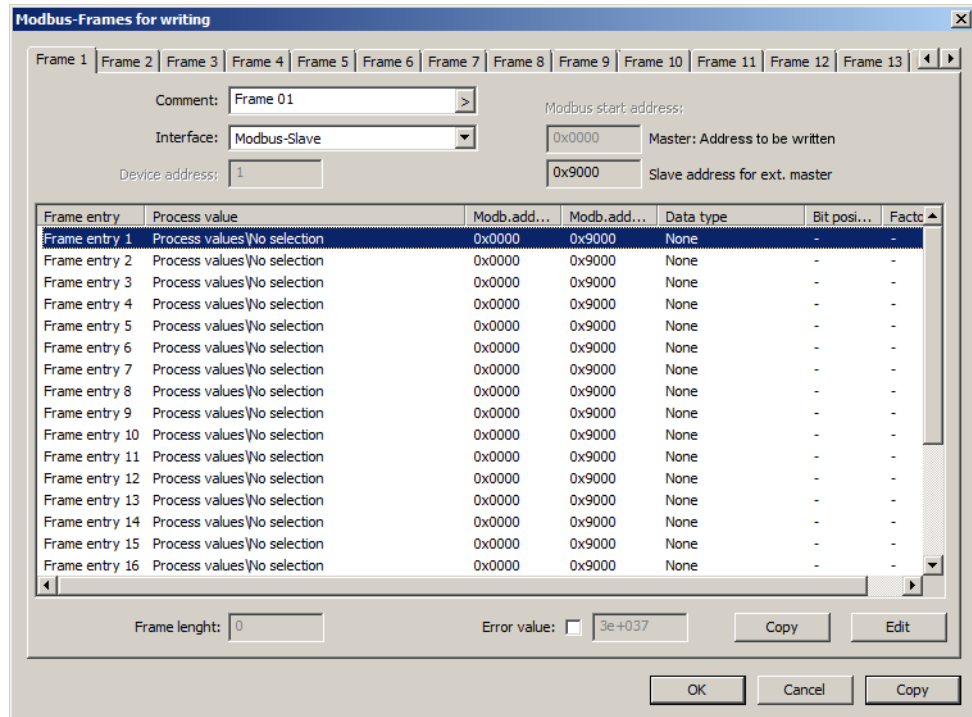

Configuration and use of the Modbus frames for writing is described in the interface description.

⇒ Chapter 1.4.2 "Device documentation in the form of PDF files", page 16

9 Configuration – in setup program only

9.9 Customer-specific linearization

You can use the customer-specific linearization to create a customized linearization characteristic line for analog inputs. This characteristic line is used for all analog inputs for which the corresponding linearization has been selected in the configuration.

Customer-specific linearization can only be programmed with the setup program. Two procedures are available for this (type of linearization): grid points (value pairs) or formulas.



NOTE!

It is possible to create different characteristic lines with grid points and formulas. The characteristic line that matches the formula is authoritative for use in the module, however. If the grid points and formula are not compatible, when you press "OK" to exit the dialog, a warning is output. You can delete the grid points or recalculate the formula on the basis of the grid points.

Signal flow

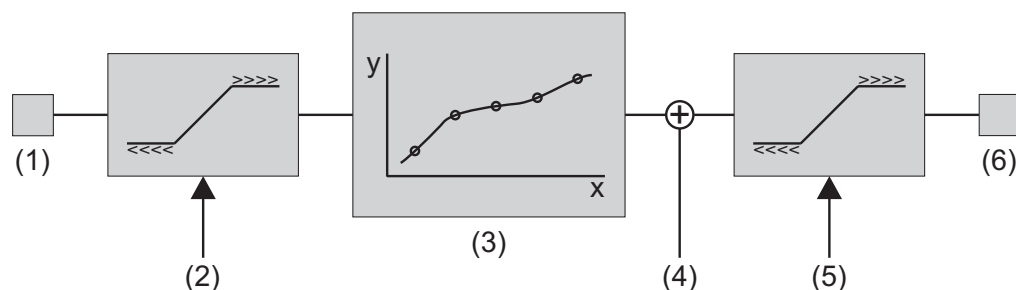

- | | |
|---|--|
| (1) Measured value | (4) Offset (normalized) |
| (2) Monitoring of measured values for standard signals (limits as per NAMUR) | (5) Monitoring of linearized values with regard to scaling (configuration parameter: Scaling start, Scaling end) |
| (3) Linearization (grid points/formula)
Grid points: Monitoring of the definition range (measured values)
Formula: Monitoring of the value range (linearized values) with regard to the measuring range (configuration parameter: Measuring range start, Measuring range end) | (6) Linearized value |

9 Configuration – in setup program only

Measured value

The following table shows the admissible measured value range of the analog inputs as a function of the selected sensor. These values represent the minimum and maximum input values of customer-specific linearization.

Sensor	Lower limit	Upper limit	Comment
RTD temperature probes	0 Ω	400 Ω or 4000 Ω	Upper limit depending on configuration
Thermocouple	0 mV	100 mV	
Resistance transmitter	0 %	100 %	Loop generation as a percentage of the total resistance (max. 4000 Ω)
Resistance/potentiometer	0 Ω	400 Ω or 4000 Ω	Upper limit depending on configuration
Current 0 ... 20 mA	0 mA	20.625 mA	Underrange is not detected.
Current 4 ... 20 mA	3.8 mA	20.5 mA	
Voltage 0 ... 70 mV	-0.875 mV	72.1875 mV	
Voltage 0 ... 1 V	-0.0125 V	1.03125 V	
Voltage -1 ... +1 V	-1.025 V	1.0625 V	
Voltage 0 ... +10 V	-0.125 V	10.3125 V	
Voltage -10 ... +10 V	-10.25 V	10.625 V	



NOTE!

The measured value is monitored for current and voltage signals. The current and voltage values stated in the table are limits based on the NAMUR recommendation NE 43 (exception: lower limit for current 0 ... 20 mA). A measured value outside of these limits results in a deviation above or below the measuring range (out of range).

Linearization

Depending on the selected linearization type, the definition range or value range of the linearization is monitored.

- ⇒ Chapter 9.9.1 "Grid points", page 224
- ⇒ Chapter 9.9.2 "Formula", page 225

Linearized value

The linearized value is monitored with regard to the scaling range (start, end). The range of the linearized values (possibly incl. offset) is thus delimited as follows:

Lower limit = Minimum (start, end) - |end - start| × 0.0125

Upper limit = Maximum (start, end) + |end - start| × 0.03125



NOTE!

A linearized value outside of these limits results in a deviation above or below the measuring range (out of range).



NOTE!

A linearized value that represents a temperature value must be given only in °C.

9 Configuration – in setup program only

9.9.1 Grid points

Customer-specific linearization is specified by entering up to 40 grid points (pairs of values X/Y). The value of X stands for the physical measured value (e.g., voltage in mV, current in mA, or resistance in ohm; depending on the sensor type) and the value of Y stands for the linearized value (e.g., temperature in °C).

Setup dialog

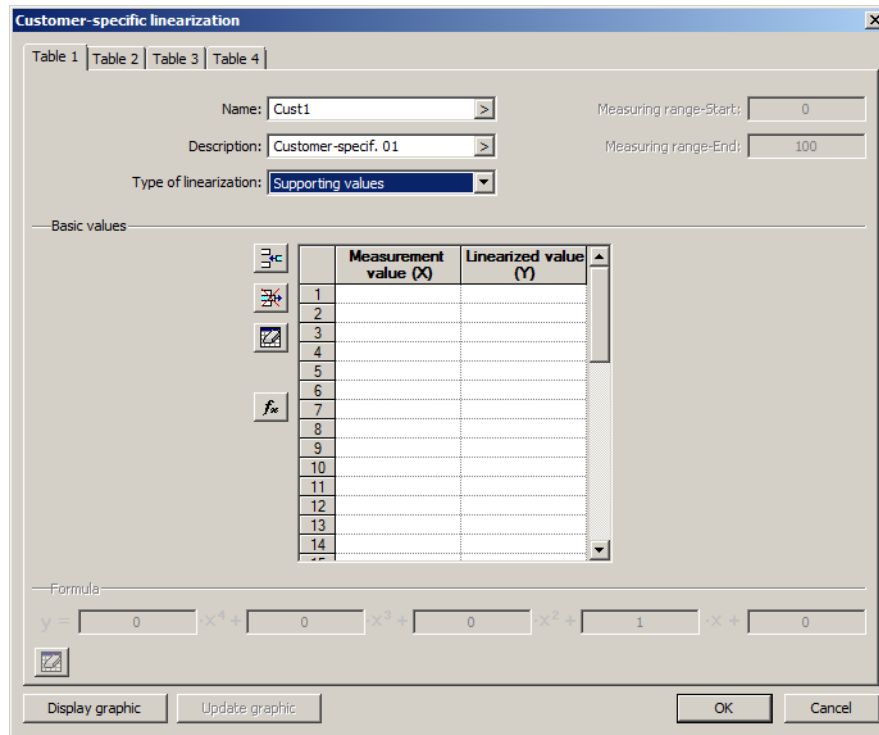

Parameters

Parameters	Selection/settings	Description
Measured value (X)	-99999 ... 0 ... +99999	Value of the relevant grid point on the x axis
Linearized value (Y)	-99999 ... 0 ... +99999	Value of the relevant grid point on the y axis Always give a temperature value in °C.

The definition range of linearization (measuring values, x axis) is monitored in the module and limited as follows:

Lower limit of the definition range = $X_{min} - 0.0125 \times (X_{max} - X_{min})$

Upper limit of the definition range = $X_{max} + 0.03125 \times (X_{max} - X_{min})$



NOTE!

A measured value that lies outside of the definition range results in a deviation above or below the measuring range (out of range).

Displaying linearization on a graphic ("Display graphic" button)

Use this button to create a graphic of the linearization.

9 Configuration – in setup program only

The graphic includes the characteristic lines for both types of linearization where applicable, namely the grid points (table) and the formula.

The display range for the graphic is initially determined by the smallest and largest grid points; it can be temporarily changed in the display by entering different x values.

Calculating the polynomial using the grid points ("fx" button)

After entering the value pairs, use this button to calculate a polynomial that describes the progression of the linearization characteristic line.

The calculated coefficients are incorporated into the formula. The characteristic lines for both types of linearization then correspond to each other.

If the x values do not increase in a straight line, the linearization is not applied. In this case, it is impossible to display the graphic or calculate the polynomial.

9.9.2 Formula

Customer-specific linearization is specified using a 4th order polynomial. The polynomial is calculated for the entire linearization range.

Polynomial formula: $y = X4 \cdot x^4 + X3 \cdot x^3 + X2 \cdot x^2 + X1 \cdot x + X0$

Setup dialog

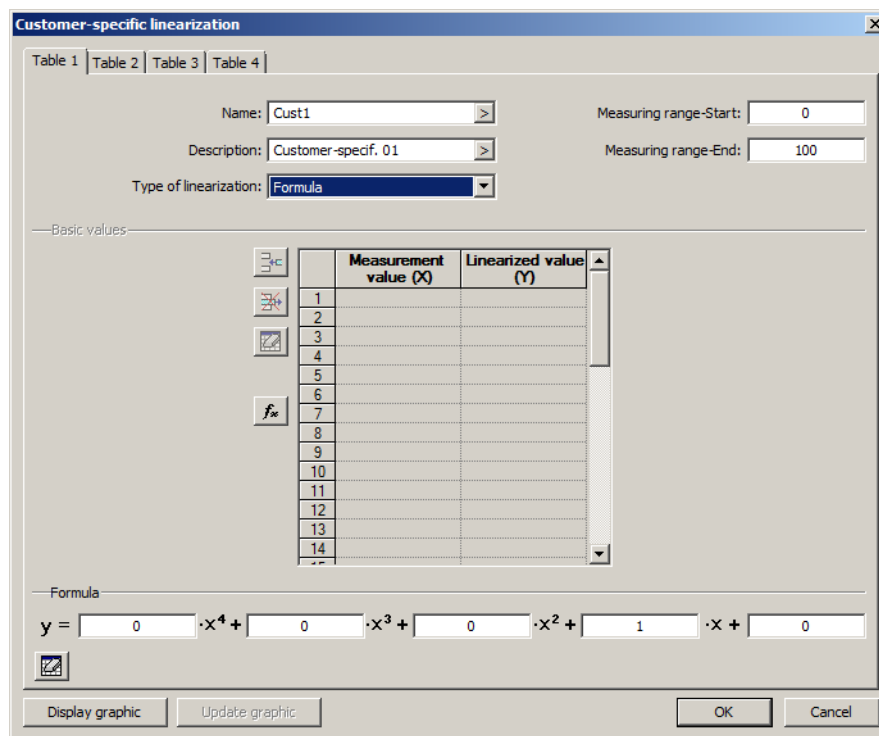

Parameters

Parameters	Selection/settings	Description
Measuring range start (Ymin)	-99999 ... 0 ... +99999	Start value of the y axis Always give a temperature value in °C.
Measuring range end (Ymax)	-99999 ... 100 ... +99999	End value of the y axis Always give a temperature value in °C.

9 Configuration – in setup program only

Parameters	Selection/settings	Description
X0	-99999 ... 0 ... +99999	Absolute component of the polynomial (point of intersection with the y axis)
X1	-99999 ... 1 ... +99999	Coefficient of the linear component (x)
X2	-99999 ... 0 ... +99999	Coefficient of the quadratic component (x ²)
X3	-99999 ... 0 ... +99999	Coefficient of the cubic component (x ³)
X4	-99999 ... 0 ... +99999	Coefficient of the quartic component (x ⁴)

The value range for the linearization (linearized values, y axis) is monitored in the module and limited as follows:

Lower limit of the value range = $Y_{min} - 0.0125 \times (Y_{max} - Y_{min})$

Upper limit of the value range = $Y_{max} + 0.03125 \times (Y_{max} - Y_{min})$



NOTE!

A linearized value that lies outside of the value range results in a deviation above or below the measuring range (out of range).

Displaying linearization on a graphic ("Display graphic" button)

Use this button to create a graphic of the linearization.

The graphic includes the characteristic lines for both types of linearization where applicable, namely the formula and the grid points (table).

The display range for the graphic is initially determined by the "measuring range start" and "measuring range end" values (y values); it can be temporarily changed in the display by entering different x values.

9 Configuration – in setup program only

9.10 Process screens

Process screens are used for visualizing process data. The setup program can be used to create up to 6 individual process screens that are transferred to the device and are available there in the "View" menu.

The size of a process screen (background) is 640 pixels (width) by 379 pixels (height).

9.10.1 Process screen editor



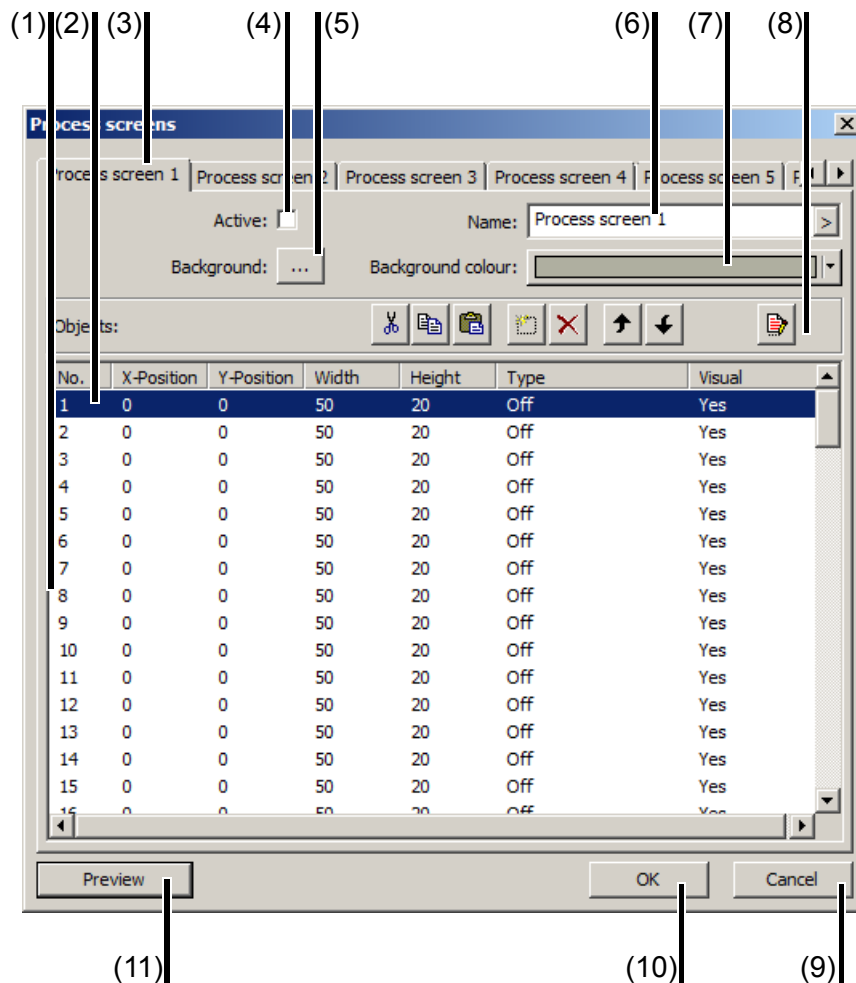





Setup dialog



- (1) Object list
- (2) Object used
- (3) Selected process screen
- (4) Activate process screen
- (5) Select background image
- (6) Name of the process screen
- (7) Select background color
- (8) Navigation and processing functions
- (9) Exit process screen editor; settings are not adopted
- (10) Exit process screen editor; settings are adopted
- (11) Preview of the process screen (preview window is opened in the setup program)

9 Configuration – in setup program only

Navigation and processing functions

Button	Function
	Cut object from the object list
	Copy object to another object (only within the same process screen)
	Paste cut object into the object list
	Add new object to the object list
	Remove object from the object list
	Move object up in object list
	Move object down in object list
	Edit object

9.10.2 Create process screen

A process screen is created in the following way:

Step	Activity
1	Select the process screen to be created (Process screen 1 to Process screen 6) by left-clicking on it.
2	Select the object (Objects 1 to 100) in the object list by left-clicking on it.
3	Start editing the object features by using the left mouse button to double-click on the selected object or by clicking the () symbol.
4	Edit features and close the dialog with OK.
5	Inspect the object in the simulation. Change the features of the object if required.
6	Select and edit additional objects.
7	Change the default name of the process screen (if required).
8	Configure the background image ("Background") and the background color, if required (the background color can only be seen if the background image does not cover the entire process screen area or if the "Transparent" option was selected when importing the image).
9	Activate the process screen (only activated process screens are transferred to the device).
10	OK transfers the process screen to the setup file.
11	Transfer the setup file to the device.
12	On the device, select the "Process screen" visualization (view).

9 Configuration – in setup program only

9.10.3 Background

In addition to the background color, a background image can also be used for the background of the process screen. The background image is selected from the list of available screens in the setup program. If the background color is to be visible, the background image must not cover the entire area of the process screen or it must be transparent (option when replacing a screen).

The list can contain up to 50 images that are used as the background image or pictogram. 10 MB storage space is available on the device for all images. The required storage space is determined in the setup program; it may thus be impossible to add more images to the list.

Setup dialog

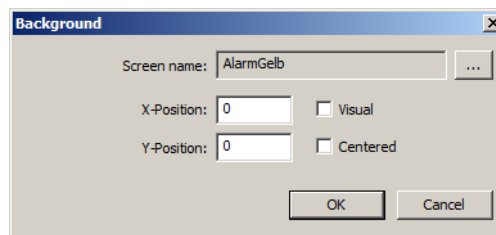

Parameters

Parameters	Selection/settings	Description
Image name	Selection from list of images	Background image for the process screen
X position	0 ... 639	X coordinate of the upper left corner of the background image in the process screen
Y position	0 ... 378	Y coordinate of the upper left corner of the background image in the process screen
Visible	Yes (<input checked="" type="checkbox"/>) , No (<input type="checkbox"/>)	"Yes" releases the display of the background image in the process screen.
Centered	Yes (<input checked="" type="checkbox"/>) , No (<input type="checkbox"/>)	"Yes" horizontally and vertically centers the background image in the process screen (X and Y position are then unimportant).

The "..." button is used to open the list of the available images in the setup program:

9 Configuration – in setup program only

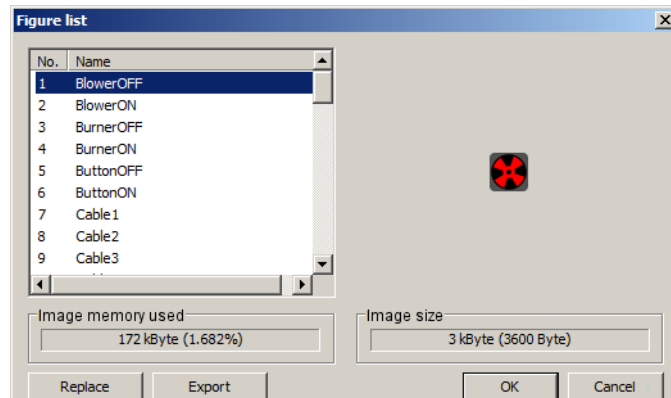

"Replace" button: The selected image is replaced by a different image, which must be selected from a file directory as a graphic in BMP or PNG format (max. 640 × 379 pixels; 16-bit color depth). During this process, the name (title) under which the image appears in the list can be changed so that it is different from the file name. If the "Transparency: Color pixel top left" option is active (checked), all pixels or areas that use the same color as the pixel top left are transparent in the process screen.



NOTE!

For an image to be displayed correctly in the online visualization, it should always be imported as a PNG format graphic. Transparent areas must be created with a graphics program up front. The "Transparency: Color pixel top left" option cannot be used for this.



NOTE!

If you import an image with a higher resolution, the process screen editor scales the image to the maximum admissible size. The aspect of the original image is kept. Similarly the color depth of the image is reduced to 16-bit if the image file you are importing uses more colors.

"Export" button: the selected pictogram is saved in a file directory as a graphic in BMP format.

9.10.4 Object types for process screens (overview)

The following object types are available when editing object features:

Type	Description
Pictogram	The status of a digital signal is graphically depicted using two pictograms (icons or images).
Analog signal	The value of an analog signal is displayed in numerical form (e.g. 123.45).
Digital signal	The status of a digital signal is displayed within a frame via a text (e.g. Low, High).
Text	Text that is displayed in the process screen. This is a fixed text that is entered when editing the object.
Frame	Frame for grouping or highlighting objects The area within the frame is transparent and is automatically placed in the background. An object (e.g., text or image) located within this frame is made visible as a result.
Rectangle	Rectangle for grouping or highlighting objects Unlike the frame, the rectangle is not transparent (separate color can be set). As a result, objects can be arranged against a background with a color that differs from that of the general background color.

9 Configuration – in setup program only

Type	Description
Bar graph	The value of an analog signal is displayed as a bar graph (vertical or horizontal).
Universal display	Field for displaying the properties of an analog signal (e.g., channel designation, scaling, unit, limit value)
Float value entry	Field for entering a float value The value is assigned to an analog variable (selection of a selector).
Text entry	Field for entering a text The text is assigned to a text variable (selection of a selector).
Digital value entry	Field for selecting a binary value (low, high) The value is assigned to a digital variable (selection of a selector).

9.10.5 General object features

The description of the general object features applies for all object types for which the parameters in question are available.

The specific object features are described in the following chapters under the corresponding object type.

Setup dialog

Parameters

Parameters	Selection/settings	Description
Type	Selection from list of object types	Object type for the process screen
X position	0 ... 10 ... 639	X coordinate of the upper left corner of the object in the process screen
Y position	0 ... 20 ... 378	Y coordinate of the upper left corner of the object in the process screen
Width	1 ... 50 ... 640	Width of the object

9 Configuration – in setup program only

Parameters	Selection/settings	Description
Height	1 ... 20 ... 379	Size of the object
Visible	Yes (<input checked="" type="checkbox"/>) , No (<input type="checkbox"/>)	"Yes" releases the display of the object in the process screen.
Editable	Yes (<input checked="" type="checkbox"/>) , No (<input type="checkbox"/>)	"Yes" enables the option for entry in the process screen (only for input objects).
Background color	Select color (dropdown menu) or enter the color code (integer value).	Background color of the object
Transparent	Yes (<input checked="" type="checkbox"/>) , No (<input type="checkbox"/>)	If "Yes", the background color of the object is not active. Instead, the font will be displayed in front of the background color of the process screen.
Frame shape	Select form (drop-down menu).	The object can be provided with a frame.
Foreground color 	Select color (drop-down menu).	Font color within the object
Font size	Select font size (drop-down menu).	Font size within the object
Alignment	Select alignment (drop-down menu).	Alignment of the font within the object (left-aligned, right-aligned, centered)
Orientation	Select orientation (drop-down menu).	Orientation of the object in the process screen (horizontal, vertical; not for input objects).

Foreground color

In order for the font to be visible, the foreground and background color must be different from each another. If the "Transparent" setting is selected () , this applies with regard to the background color of the process screen.

Preview

If the dialog is exited using the "OK" button, the simulation opens in the setup program.
⇒ Chapter 9.10.7 "Preview screen", page 244

9 Configuration – in setup program only

9.10.6 Individual objects

Pictogram

Setup dialog

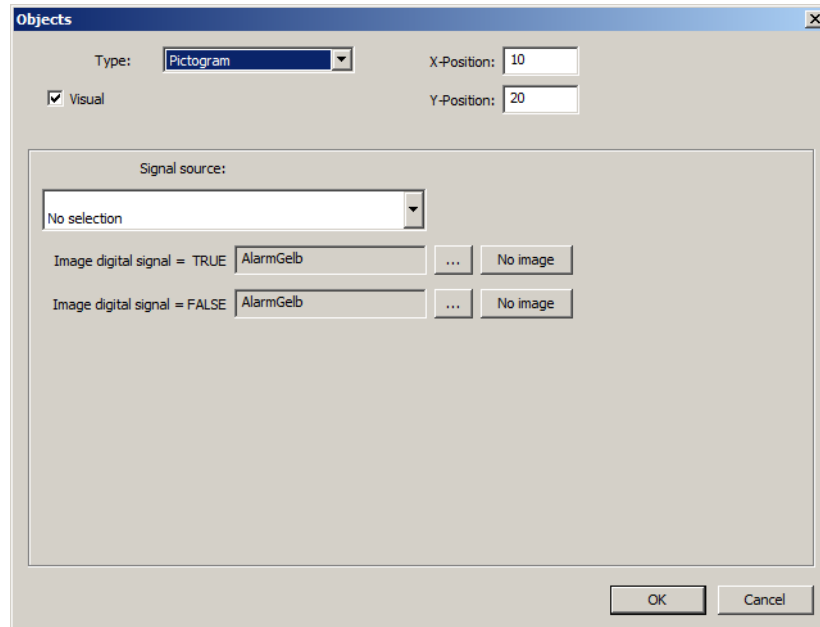

Parameters

Parameters	Selection/settings	Description
Signal source	Digital signal whose status is displayed via the corresponding pictogram.	
	No selection Select signal.	No signal selected. (Pictogram for FALSE (0) will be displayed.) Digital selector
Image digital signal = TRUE	Select the "..." button and select the image from the list (or select "No image").	Pictogram for displaying the status TRUE (1).
Image digital signal = FALSE	Select the "..." button and select the image from the list (or select "No image").	Pictogram for displaying the status FALSE (0).

9 Configuration – in setup program only

Analog signal

Setup dialog

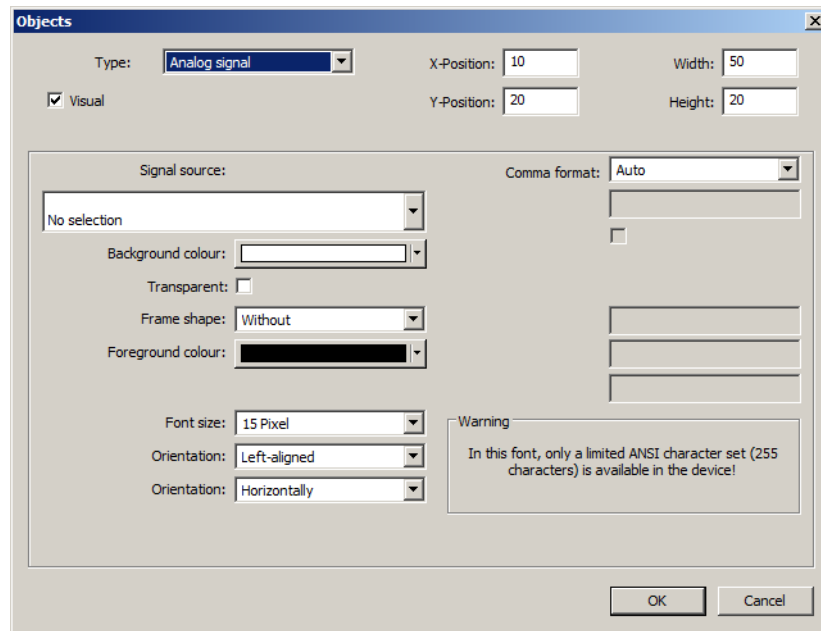

Parameters

Parameters	Selection/settings	Description
Signal source	Analog signal whose value within the object is displayed numerically.	
	No selection No signal selected. (Display: -----) Select signal.	Analog selector
Comma format (decimal place)	Select format (drop-down menu).	Number of decimal places of the displayed value

9 Configuration – in setup program only

Digital signal

Setup dialog

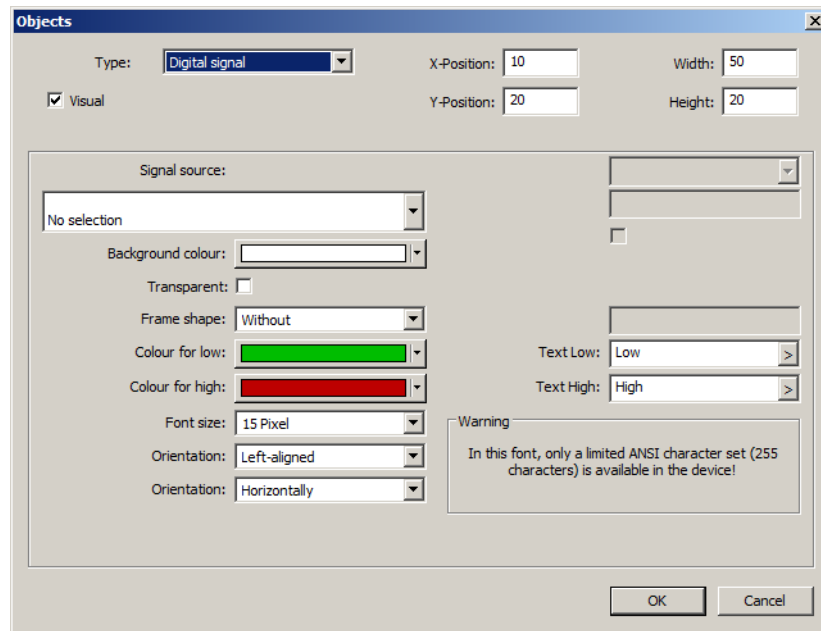

Parameters

Parameters	Selection/settings	Description
Signal source	Digital signal whose status within the object is displayed via a text.	
	No selection	No signal selected. (Text for low condition will be displayed.)
	Select signal.	Digital selector
Color for Low	Select color (drop-down menu).	Font color (Text Low) within the object (foreground color)
Color for High	Select color (drop-down menu).	Font color (Text High) within the object (foreground color)
Text Low	Enter text (or use default text).	Text for low condition
Text High	Enter text (or use default text).	Text for high condition

9 Configuration – in setup program only

Text

Setup dialog

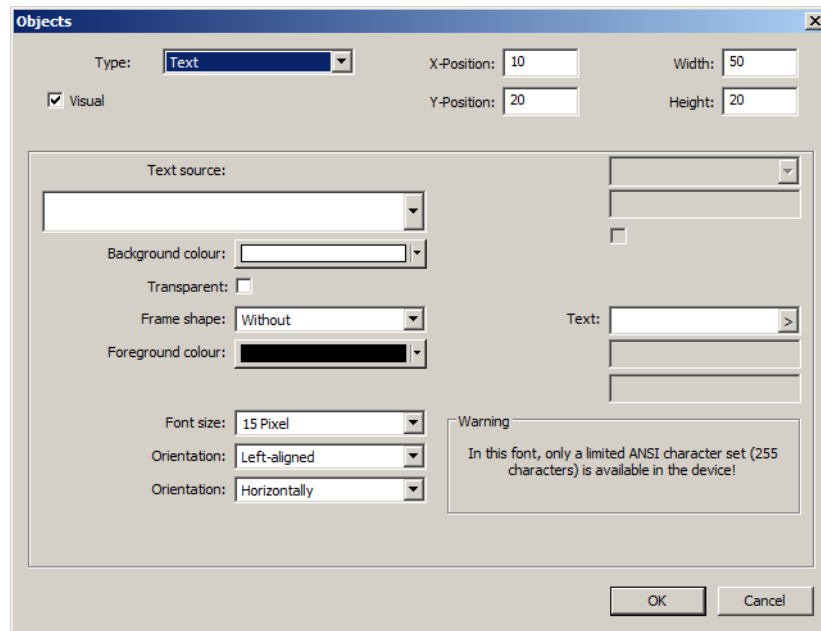

Parameters

Parameters	Selection/settings	Description
Text source	Text source whose text is displayed within the object.	
	No selection Select signal.	No text source selected. The selection must be of the "Text" data type.
Text	Enter text	Text that is displayed within the object. This text is used if no text source was selected, or if the text source does not return any text.

9 Configuration – in setup program only

Frame

Setup dialog

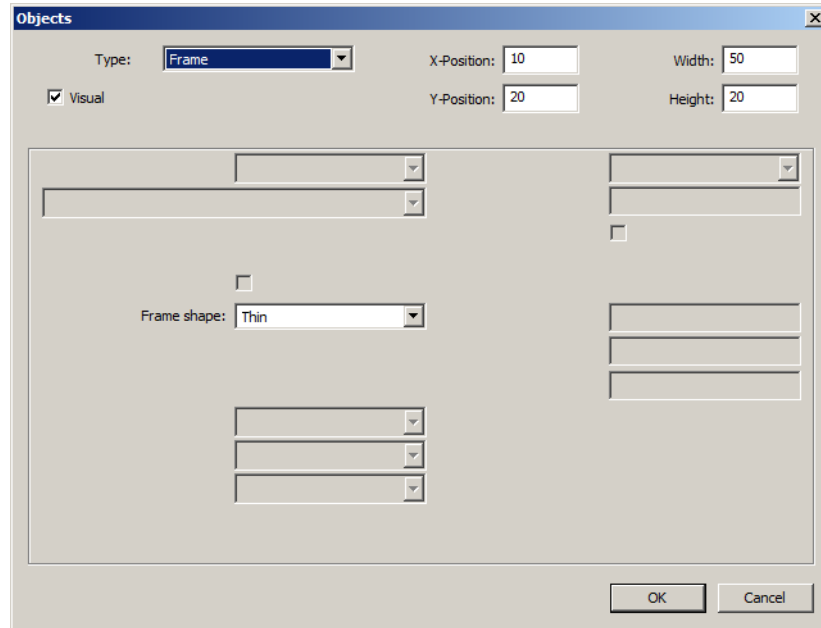

Parameters

Parameters	Selection/settings	Description
Frame shape	Select form (drop-down menu).	Frame (black) for grouping or highlighting objects The area within the frame is transparent and is automatically placed in the background. An object (e.g., text or image) located within this frame is made visible as a result.

9 Configuration – in setup program only

Rectangle

Setup dialog

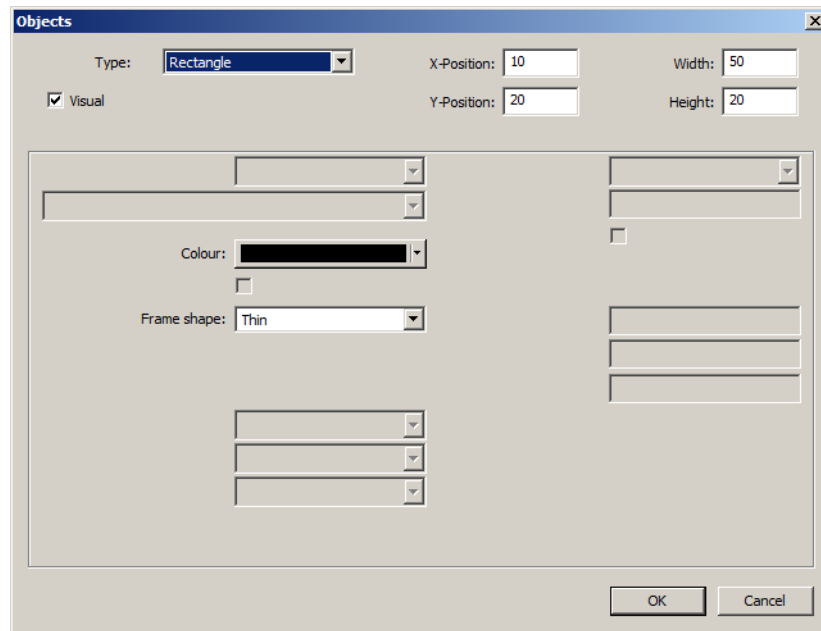

Parameters

Parameters	Selection/settings	Description
Color	Select color (drop-down menu).	Color of the rectangle surface Unlike the frame, the rectangle is not transparent, although it is automatically in the background. As a result, objects can be arranged against a background with a color that differs from that of the general background color.
Frame shape	Select form (drop-down menu).	The rectangle can also be provided with a (black) frame.

9 Configuration – in setup program only

Bar graph

Setup dialog

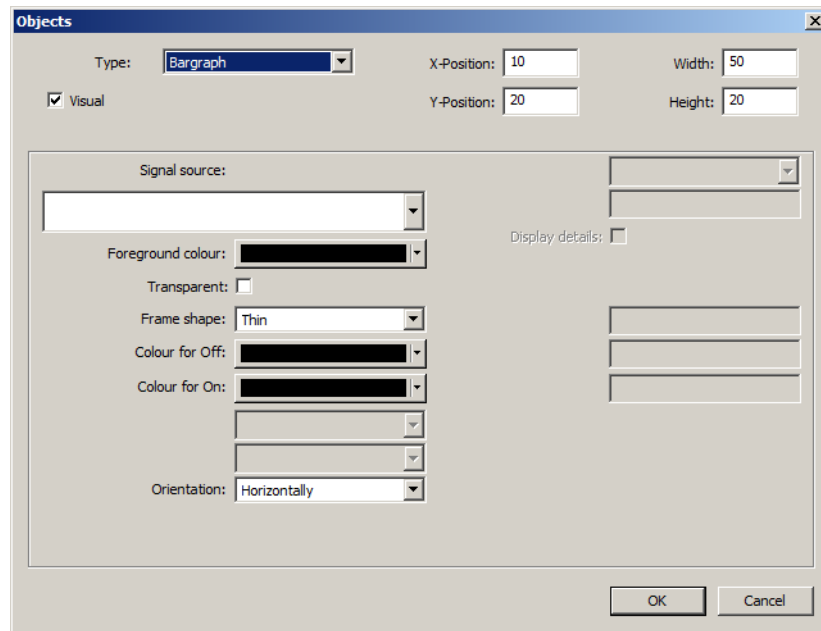

Parameters

Parameters	Selection/settings	Description
Signal source	Analog signal whose value is displayed as a bar graph.	
	No selection Select signal.	No signal selected. (Display: Bar at "0") Analog selector
Foreground color	Select color (drop-down menu).	Color for displaying details
Color for Off	Select color (drop-down menu).	Color of the bar background within the object (background color)
Color for On	Select color (drop-down menu).	Color of the bar within the object (foreground color)
Show details	Yes (<input checked="" type="checkbox"/>) , No (<input type="checkbox"/>)	If "Yes," alarms (Alarm 1 left, Alarm 2 right) and range limits (upper and lower) are displayed.

9 Configuration – in setup program only

Universal display

Setup dialog

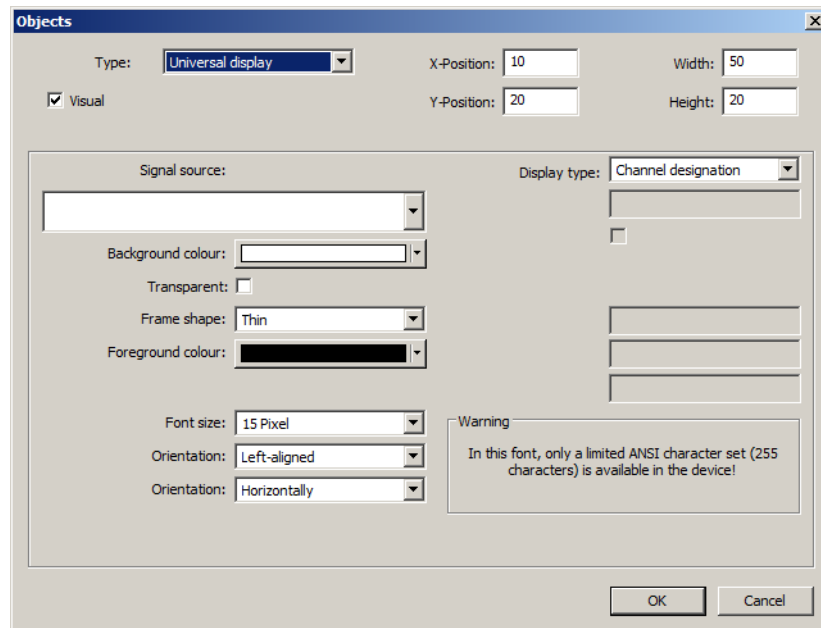

Parameters

Parameters	Selection/settings	Description
Signal source	Analog signal whose feature is displayed.	
	No selection	No signal selected (the process screen shows an empty field with the background color).
	Select signal.	Analog selector
Display type 	Select the display type (drop-down menu).	The display type (analog signal feature) is displayed in the process screen.

Display type

The following display types are available:

- Channel designation, channel description
- Scaling start, scaling end
- Unit
- Limit value Alarm 1, limit value Alarm 2
- Switching differential Alarm 1, Switching differential Alarm 2

9 Configuration – in setup program only

Float value entry (as of device version 02)

Setup dialog

Parameters

Parameters	Selection/settings	Description
Destination	Variable in which the entered value is written.	
	No selection Select variable.	No variable selected. Analog selector (external analog input 1 to 24; limit value monitoring 1 to 24: limit value and switching differential)
Decimal places	Select format (drop-down menu).	Number of decimal places of the displayed value
Minimum value	-99999 to 99999 (0)	Lower limit of the admissible entry area
Maximum value	-99999 to 99999 (100)	Upper limit of the admissible entry area

9 Configuration – in setup program only

Text entry (as of device version 02)

Setup dialog

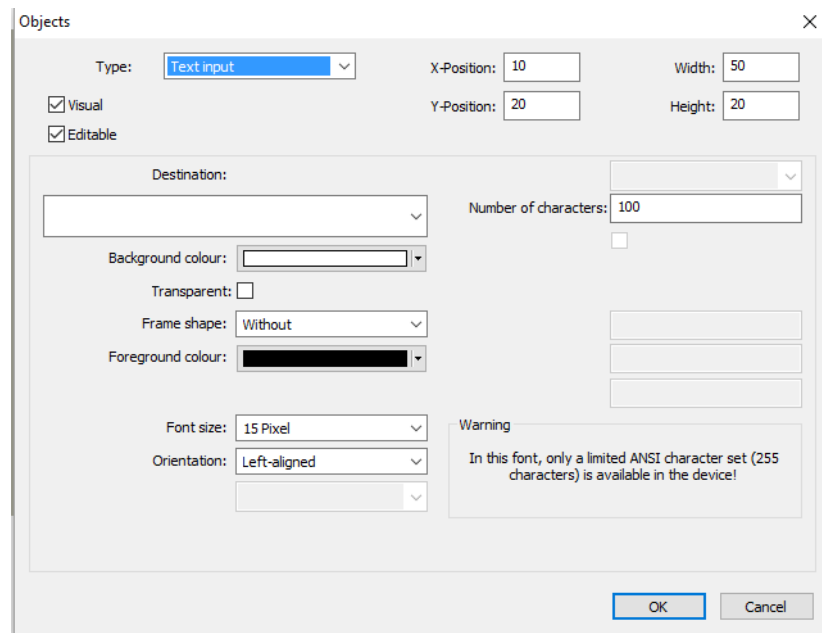

Parameters

Parameters	Selection/settings	Description
Destination	Variable in which the entered text is written.	
	No selection Select variable.	No variable selected. Text selector (external text (long) 1 to 10; external event text (long), 1 to 4)
Number of characters	0 to 160 (100)	Maximum number of characters that can be entered.

9 Configuration – in setup program only

Digital value entry (as of device version 02)

Setup dialog box

Parameters

Parameters	Selection/settings	Description
Destination	Variable to which the value is written. The value (low, high) is determined by the selection of the corresponding text (text (low), text (high)) after clicking the button in the process screen. Alternatively, the toggle function can be activated.	
	No selection Select variable.	No variable selected. Digital selector (external digital input 1 to 24)
Toggle function	Yes (<input checked="" type="checkbox"/>) , No (<input type="checkbox"/>)	By selecting "Yes" the value changes (low, high) with each click of the button in the process screen.
Text (low)	Enter text (or use default text).	Text for low condition
Text (high)	Enter text (or use default text).	Text for high condition

9 Configuration – in setup program only

9.10.7 Preview screen

A process screen that has been created can be checked and modified in the preview screen using the setup program before transferring to the device.

The preview screen is opened by touching the "Preview" button:

⇒ Chapter 9.10.1 "Process screen editor", page 227

The simulation also opens if the dialog for creating an object is exited using the "OK" button.

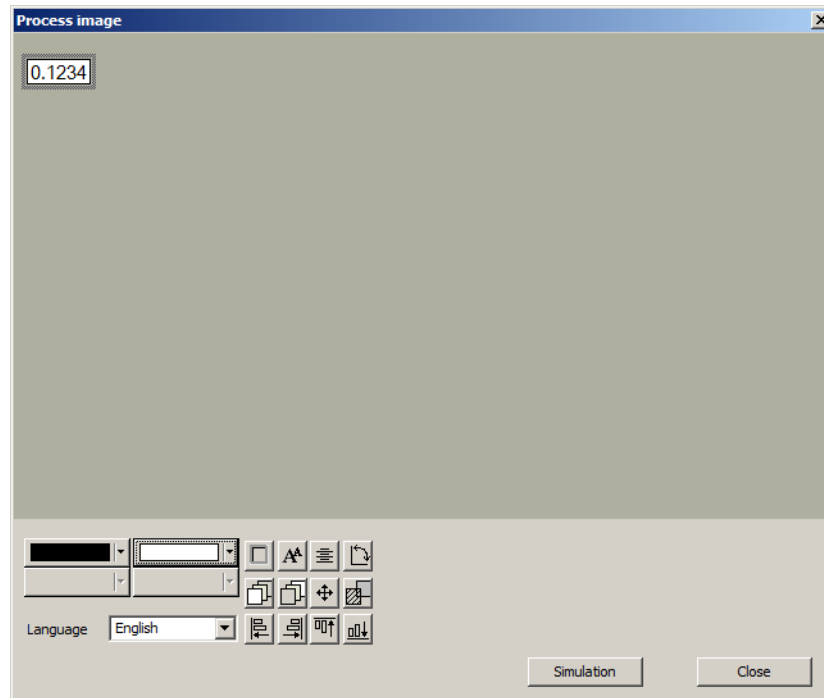

Preview screen



Processing functions

Button	Function
	Select background color (for example, font color) within the object (drop-down menu).
	Select background color of the object (drop-down menu).
	Changing the frame form of the object (none, thin, thick, raised, recessed).
	Change font size (12, 16, 24, 31, 48, 64 pixels).
	Change alignment of the font within the object (left-aligned, centered, right-aligned).
	Change orientation of the object in the process screen (horizontal, vertical).
	Moves the object in the process screen forward with each click. The object is simultaneously moved down in the object list (higher number).
	Moves the object in the process screen back with each click. The object is simultaneously moved up in the object list (smaller number).

9 Configuration – in setup program only

Button	Function
	Move object in process screen horizontally or vertically. Clicking on this button opens an additional window. This contains different arrows (buttons) for moving the object in preset steps.
	Align object in the process screen (left, right, top, bottom). Select the first object by clicking, keep the Shift key pressed, and click on another object (or more) with the left mouse button. When you click on the appropriate button, the other objects are aligned on the first object.
Language	Select language (drop-down menu) The object text is displayed in the selected language, provided it has already been entered in this language when creating the object.

Processing object features

Changes can be made directly to the object features in question using the processing functions described above. It is also possible to open the object by double-clicking (in the preview screen or in the object list) in order to process the object features.

Moving objects

The user has the following options to move an object horizontally or vertically in the preview screen:

- Double-clicking the object to open it and changing the X/Y position.
- Left-clicking and holding the object and moving it directly into the preview screen.
- Moving the object using the arrows.

9 Configuration – in setup program only



NOTE!

The functions described in this section are configured in the setup program. An active connection between the setup program and the device is required for this.

Default settings are shown in **bold** in the parameter tables.

10.1 Ethernet

Setup dialog

The screenshot shows the 'Ethernet' configuration dialog box. The 'IP address assignment' is set to 'Automatically (DHCP)'. The 'IP address' field contains '223 . 223 . 223 . 1'. The 'Subnet-Mask' field contains '255 . 255 . 255 . 0'. The 'Standard-Gateway' field contains '0 . 0 . 0 . 0'. The 'DNS-Server IP automatically' dropdown is set to 'Yes'. The 'DNS device name' field contains 'MAC000cd8094ecd-TYP7065'. The 'DNS-Server' field contains '0 . 0 . 0 . 0'. The 'OK' and 'Cancel' buttons are at the bottom.

The parameters and their settings are identical to the configuration in the device (see Chapter 7.22 "Ethernet", page 177).

10 Online parameters

10.2 Date and time

The device's date and time are configured in this dialog by transferring them from the PC on which the setup program is running.

In contrast to this, the settings for the time zone and daylight saving time are configured in the device's parameter level. You can set the date and time manually there:

⇒ Chapter 8.4 "Date and time", page 195

The date and time can also be set using a time server.

⇒ Chapter 7.26 "Time server (SNTP)", page 189

Setup dialog

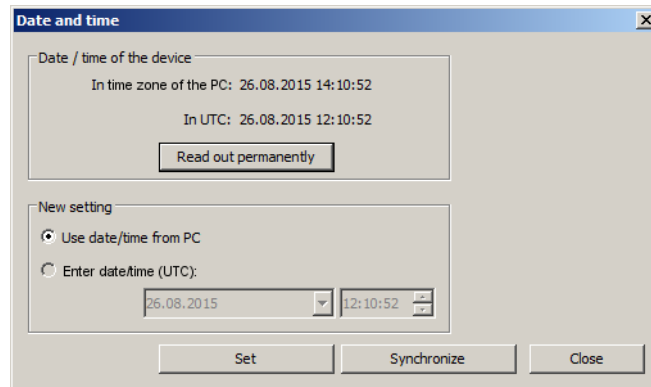

Parameters

Parameters	Selection/settings	Description
Date/time of the device	Select "Read out permanently" button	The current date and time are cyclically read out from the device. To reset the date and time, the cyclical read-out must first be cancelled ("Stop" button).
New setting	Use date/time from PC (Enter date/time (UTC))	The PC's date and time settings are used for setting the device. (This function is not supported.)
Set	Select the button	The date and time are set.
Synchronize	Select the button	The time is synchronized. If the difference between the current time in the device and the new time is greater than 30 seconds, the function is not executed.

10.3 Screenshot

The user can use this function to create a screenshot of the device's screen content.

Setup dialog

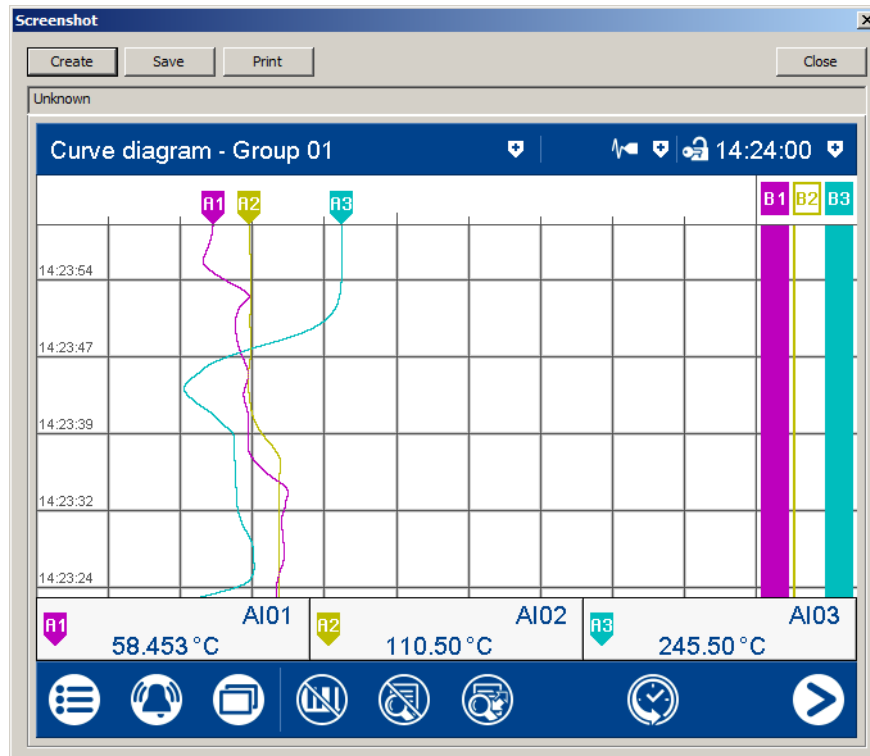

Parameters

Parameters	Selection/settings	Description
Create	Select the button	Create screenshot
Save	Select the button	Stores the screenshot as an graphic The file name and storage location are freely selectable. The file is stored as a pixel image; the most common image formats are available for selection (e.g., bmp, jpg, tif).
Print	Select the button	Print screenshot All printers installed on the PC are available for printing.

10 Online parameters

10.4 Delete recorded data

This function deletes all the data recorded in the device's register memory up to this time.



NOTE!

This function should only be used after startup of the device or after setting up a new plant.

Setup dialog

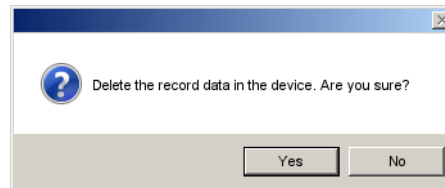

10.5 Reset user list

This function resets the user list on the device to the default settings.

Setup dialog

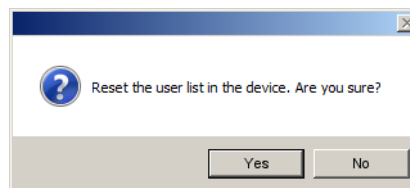

NOTE!

A device with extra code 888 (FDA; as of device version 02) does not have this function available in the setup program. The user list can only be reset with the PC Security Manager software PCS. See operating manual for PC Security Manager software PCS.

10.6 Additional process values for online data

Additional process values to be displayed as online data ("Further process values" tab) are selected in this dialog.

Setup dialog

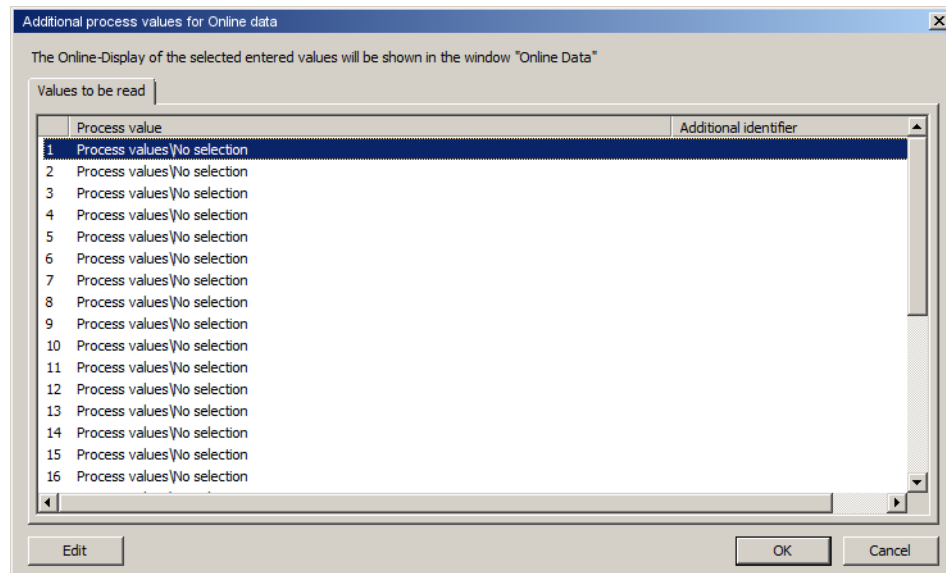

After pressing the "Edit" button (or double clicking on the relevant line), the following dialog appears; you can then select the process value:

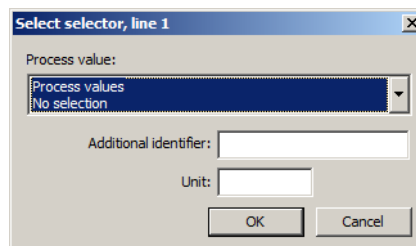

Parameters

Parameters	Selection/settings	Description
Process value	Select the process value from the selector (drop-down menu) No selection	Analog signal, digital signal, or text The selection you make is displayed in the online data "Selector" column along with the complete path from the selector. The value of the process value is shown in the "Value" column.
Additional identifier	Enter text (max. 30 characters)	Individual description of the process value The text is shown in the online data "Identifier" column.
Unit	Enter text (max. 6 characters)	Process value unit The text is shown in the online data "Unit" column.

10 Online parameters

10.7 Enabling of extra codes

You can use this function to activate additional functions (extra codes) for the devices via the setup program.

Setup dialog

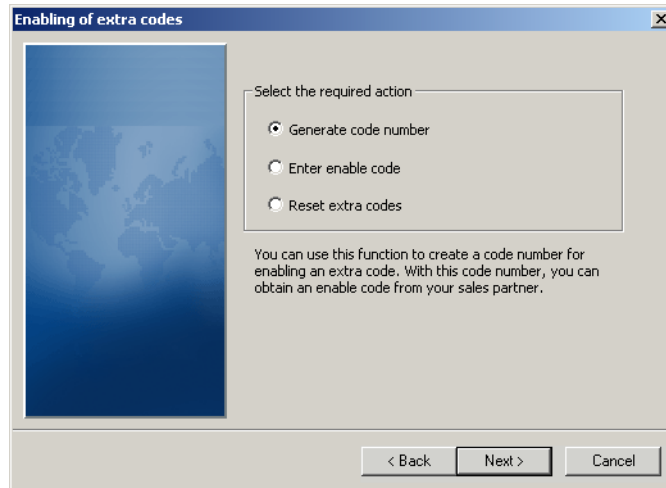

Parameters

Parameters	Selection/settings	Description
Generate code number	To generate a code number, click the function to select it and then click the "Next" button. Further instructions are then given.	This function is used to generate a code number to enable extra code. The code number is required to obtain an activation code from a sales partner.
Enter enable code	To enter an enable (activation) code, click the function to select it and then click the "Next" button. Further instructions are then given.	This function is used to activate an extra code. This requires the activation code received from the sales partner.
Reset extra codes	To reset extra codes, click the function to select it and then click the "Next" button. Further instructions are then given.	This function can be used to lock an extra code that has been activated. Locked extra codes can only be activated by re-enabling. This procedure is subject to charge.

10.8 Creation of a device certificate

Extra code 887 or 888 gives the device reliable manipulation detection. A digital device certificate provides proof that the recording data in the device has not been manipulated – which also applies to the transfer into the data archive.

The function that creates a device certificate is available as of device version 02.

Setup dialog box

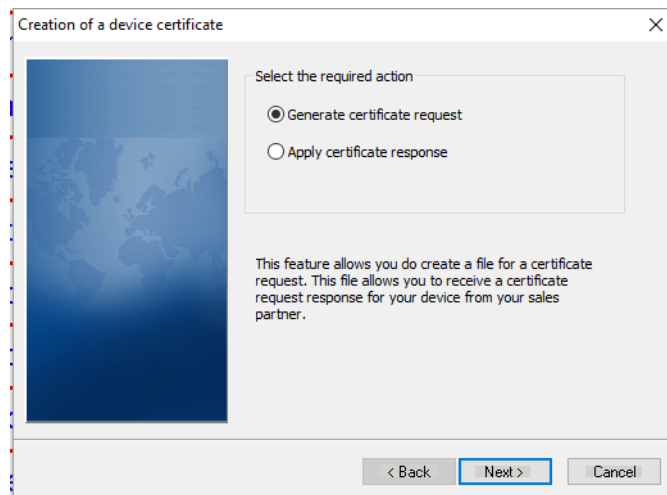

Parameters

Parameters	Selection/settings	Description
Generate certificate request	To generate a certificate request, click the function to select it and then click the "Next" button. Follow the others instructions on the screen.	This function creates a file that includes the certificate request. The file is required to request a certificate response from the sales partner.
Apply certificate response	To apply the certificate response, click the function to select it and then click the "Next" button. Follow the others instructions on the screen.	This function transfers the certificate response to the device. For this purpose the file sent by the sales partner is required.

10 Online parameters

10.9 Calibrate / test

10.9.1 Hardware/Software

This window shows the device version numbers (basic device and I/O cards), information on calibration, and various IDs.

Setup dialog

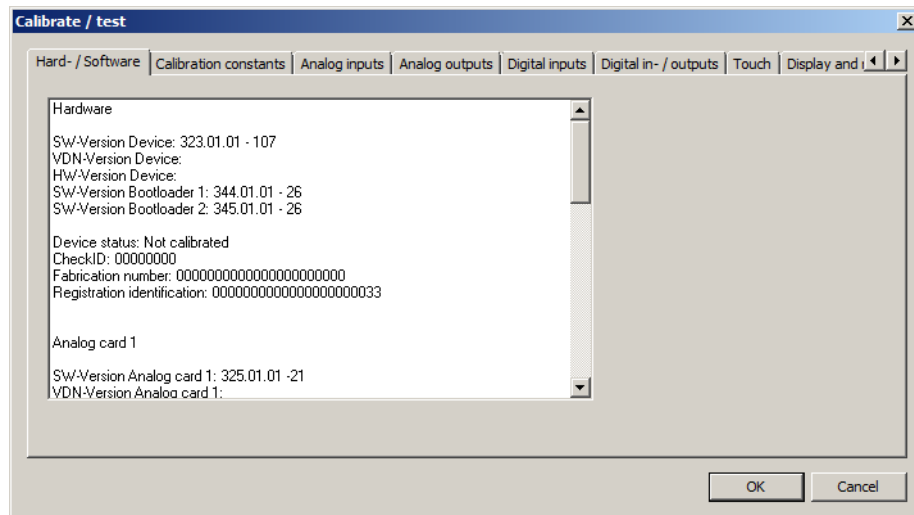

10.9.2 Calibration constants

This window displays the calibration constants for the analog inputs and outputs.

Setup dialog

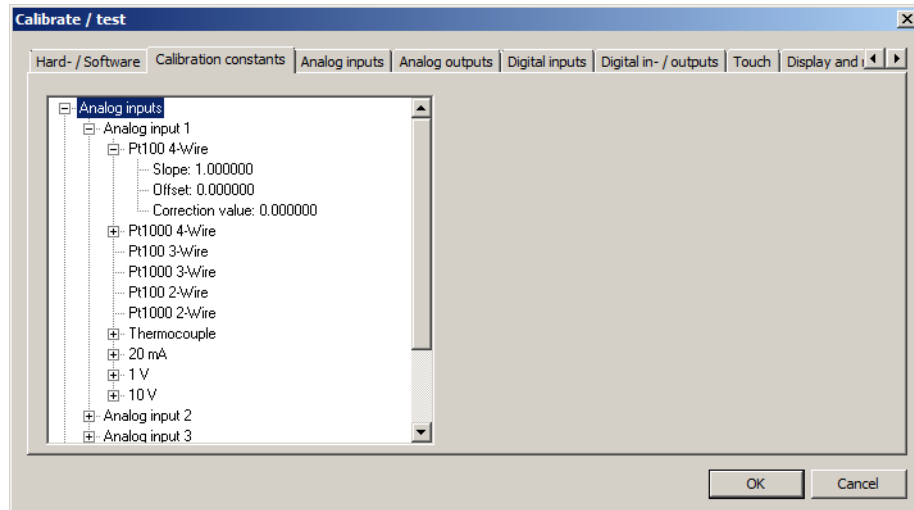

10.9.3 Analog inputs

This function tests the analog inputs. To allow this to happen, the appropriate signal or resistance must be in place at the relevant analog input.

Setup dialog

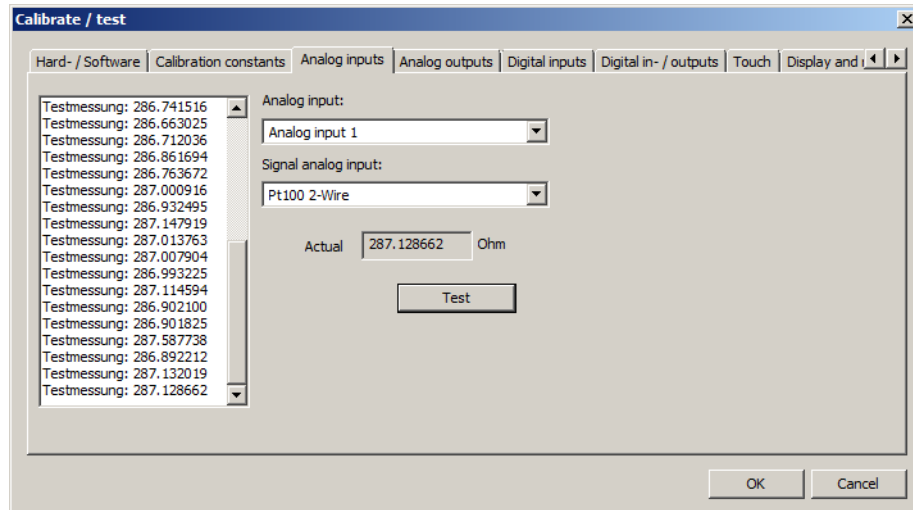

After pressing the "Test" button, the value at the analog input is continuously measured and displayed in the "Act. value" (last value) field as well as in the display field (left; all measured values). The continuous measurement is terminated by pressing "Stop:"

10.9.4 Analog outputs

This function tests the analog outputs. The signal at the relevant analog output must be measured for this purpose.

Setup dialog

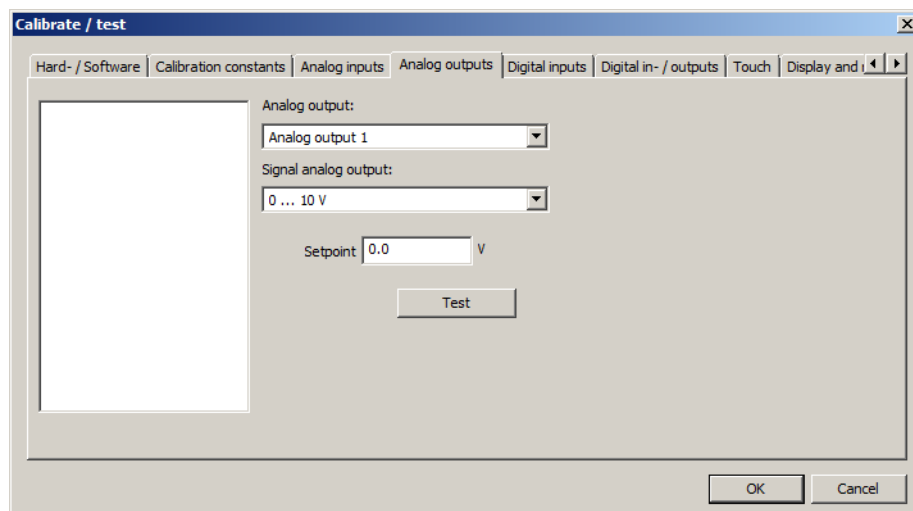

After selecting the signal type (0 to 10 V or 0 to 20 mA) and entering the target value, the matching value is output at the relevant analog output by pressing the "Test" button. The output value must be measured and compared with the target value.

10 Online parameters

10.9.5 Digital inputs

This function tests the digital inputs.

Setup dialog

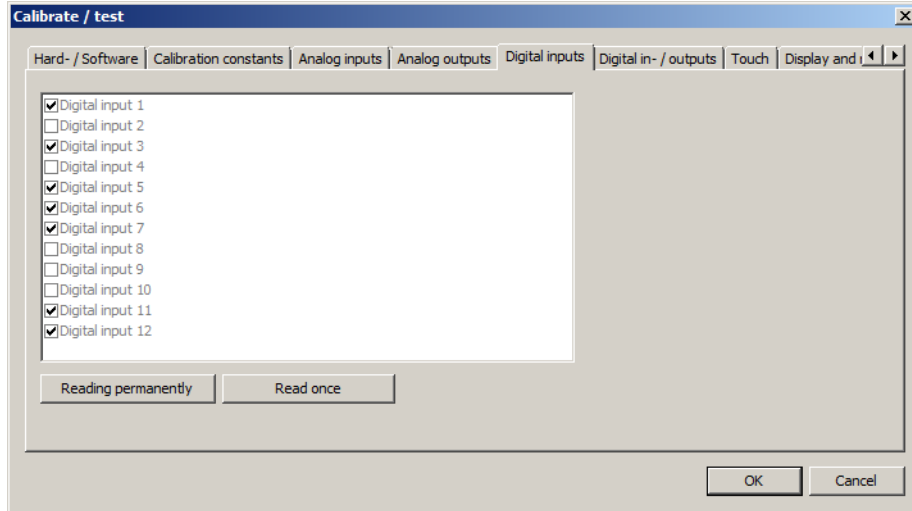

If the level at an input is "High," this is indicated with a check mark in the checkbox.

10.9.6 Digital inputs/outputs

This function tests the digital inputs/outputs. You can toggle between input and output in each case.

Setup dialog

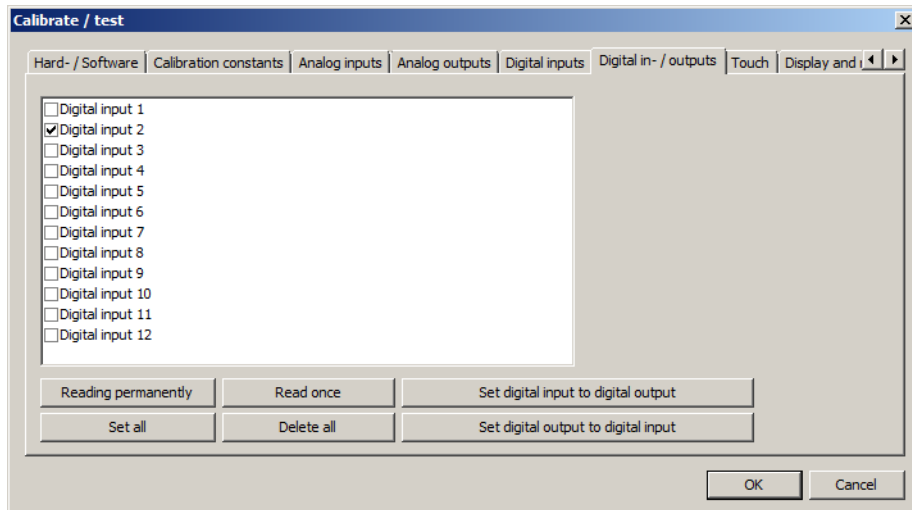

If the level at a digital input is "High," this is indicated with a check mark in the checkbox. To toggle between digital input and digital output (and back), click on the line and then press the corresponding button.

A digital output is set to "High" by checking the relevant checkbox.

10.9.7 Touch

This function is used to calibrate the screen's touch function.

Setup dialog

	Top LH	Bottom LH	Top RH	Bottom RH
Minimum value X:	0	0	3600	3600
Constant X:	295	261	3881	3878
Maximum value X:	600	600	4095	4095
Minimum value Y:	0	3300	0	3300
Constant Y:	406	3829	414	3777
Maximum value Y:	700	4095	700	4095

The current values of the parameters are read out from the device when opening the dialog. They are for information purposes only and cannot be changed by the user.

Parameters	Description
Minimum value X	Left limit of the respective centering field (top left, bottom left, top right, bottom right)
Constant X	X coordinate of the center point of the respective centering field
Maximum value X	Right limit of the respective centering field
Minimum value Y	Lower limit of the respective centering field
Constant Y	Y coordinate of the center point of the respective centering field
Maximum value Y	Upper limit of the respective centering field

The calibration is started and the user must tap the centering fields that are consecutively displayed on the device screen (touch the center point of the box). The screen color briefly changes if the centering field is not touched. Following successful calibration, a corresponding message is displayed in the setup program.

10 Online parameters

10.9.8 Display and relay

This function tests the screen's color rendering and the function of the LEDs and the relay.

Setup dialog

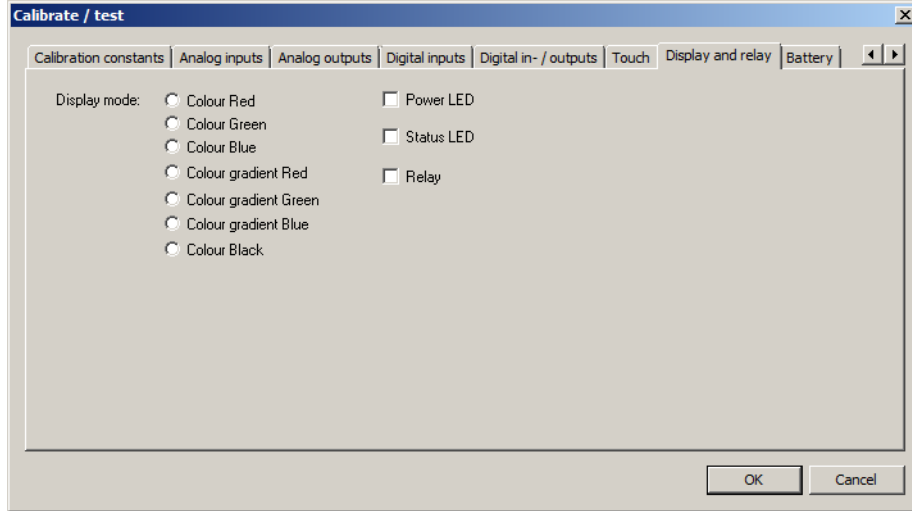

To test the color rendering, click to select the color or the color gradient. The screen then displays the relevant color pattern.

The LEDs and the relay are also enabled or disabled by clicking (checking).



NOTE!

The screen remains in this test mode until the "Calibrate/test" dialog is exited by touching the "OK" button (or until touch calibration is started).

10.9.9 Battery

This function is used to check the status of the buffer battery (OK, low, empty).

Setup dialog

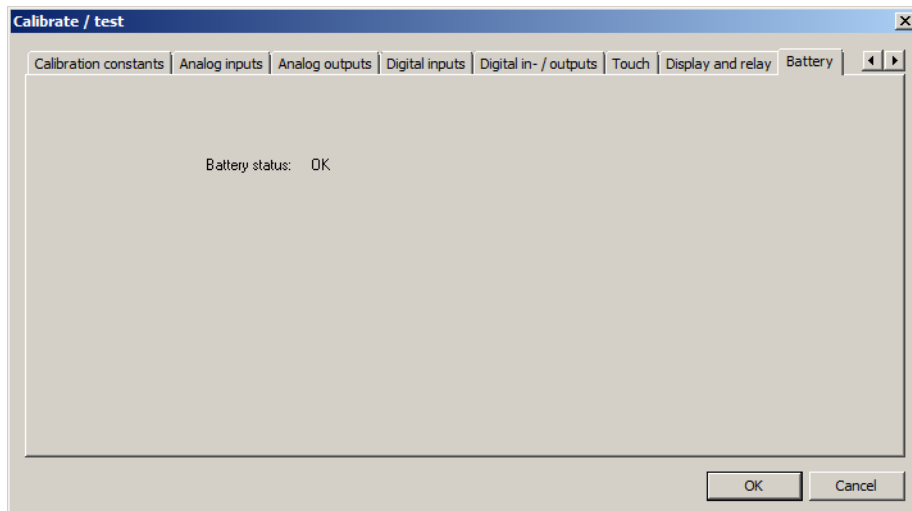

11.1 Technical data

11.1.1 Analog inputs (options 1 and 2)

General information

Quantity	0, 3, or 6
Connector number (back of device)	7 to 9, 11 to 13

Thermocouples

Description	Type	Standard	ITS	Measuring range	Accuracy ¹
Fe-CuNi	"L"	DIN 43710	ITPS-68	-200 to +900 °C	≤ 0.25 %
Fe-CuNi	"J"	IEC 60584-1	ITS-90	-210 to +1200 °C	≤ 0.25 % from -100 °C
Cu-CuNi	"U"	DIN 43710	ITPS-68	-200 to +600 °C	≤ 0.25 % from -100 °C
Cu-CuNi DIN	"T"	IEC 60584-1	ITS-90	-270 to +400 °C	≤ 0.25 % from -150 °C
NiCr-Ni DIN	"K"	IEC 60584-1	ITS-90	-270 to +1372 °C	≤ 0.25 % from -80 °C
NiCr-CuNi	"E"	IEC 60584-1	ITS-90	-270 to +1000 °C	≤ 0.25 % from -80 °C
NiCrSi-NiSi	"N"	IEC 60584-1	ITS-90	-270 to +1300 °C	≤ 0.25 % from -80 °C
Pt10Rh-Pt	"S"	IEC 60584-1	ITS-90	-50 to 1768 °C	≤ 0.25 % from 20 °C
Pt13Rh-Pt	"R"	IEC 60584-1	ITS-90	-50 to 1768 °C	≤ 0.25 % from 50 °C
Pt30Rh-Pt6Rh	"B"	IEC 60584-1	ITS-90	0 to 1820 °C	≤ 0.25 % from 400 °C
W5Re/W26Re	"C"	ASTM E230M-11	ITS-90	0 to 2315 °C	≤ 0.25 % from 500 °C
W3Re/W25Re	"D"	ASTM E1751M-09	ITS-90	0 to 2315 °C	≤ 0.25 % from 500 °C
W5Re/W20Re	"A1"	GOST R 8.585-2001	ITS-90	0 to 2500 °C	≤ 0.25 % from 500 °C
Chromel-Copel	"L"	GOST R 8.585-2001	ITS-90	-200 to +800 °C	≤ 0.25 % from -80 °C
Chromel-Alumel		GOST R 8.585-2001	ITS-90	-270 to 1372 °C	≤ 0.25 % from -80 °C
Ambient temperature influence	≤ 100 ppm/K				
Smallest measuring span	Type L (Fe-CuNi), J, U, T, K, E, N, Chromel-Alumel: 100 K Type S, R, B, C, D, A1, Chromel-Copel: 500 K				
Measuring range start/end	Freely programmable within the limits in steps of 0.1 K				
Cold junction	Internal (Pt100) or external (constant)				
Reference point accuracy (internal)	± 1 K				
Reference point temperature (external)	-30 to +85 °C (adjustable)				
Sampling rate	3 or 6 channels: 125 ms				
Input filter	Digital filter, 2nd order; filter constant can be set from 0 to 100.0 s				
Galvanic isolation	See "Galvanic isolation"				
Base measuring range	20 to 70 mV				

¹ The accuracy value refers to the maximum measuring range. Small measuring ranges lead to reduced linearization accuracy.

11 Annex

RTD temperature probe

Description	Standard	ITS	Connection type	Measuring range	Accuracy ¹	Measuring current
Pt50	IEC 751: 2008	ITS-90	2-/3-/4-wire	-200 to +850 °C	≤ 0.1 %	500 µA
Pt100	IEC 751: 2008	ITS-90	2-/3-/4-wire	-200 to +850 °C	≤ 0.1 %	500 µA
Pt500	IEC 751: 2008	ITS-90	2-/3-/4-wire	-200 to +850 °C	≤ 0.1 %	100 µA
Pt1000	IEC 751: 2008	ITS-90	2-/3-/4-wire	-200 to +850 °C	≤ 0.1 %	100 µA
Pt100	JIS 1604		2-/3-/4-wire	-200 to +650 °C	≤ 0.1 %	500 µA
Pt50	GOST 6651-2009 A.2	ITS-90	2-/3-/4-wire	-200 to +850 °C	≤ 0.1 %	500 µA
Pt100	GOST 6651-2009 A.2	ITS-90	2-/3-/4-wire	-200 to +850 °C	≤ 0.1 %	500 µA
Cu50	GOST 6651-2009 A.3	ITS-90	2-/3-/4-wire	-180 to +200 °C	≤ 0.4 %	500 µA
Cu100	GOST 6651-2009 A.3	ITS-90	2-/3-/4-wire	-180 to +200 °C	≤ 0.4 %	500 µA
Ni100	DIN 43760	ITPS-68	2-/3-/4-wire	-60 to +250 °C	≤ 0.2 %	500 µA
Ni100	GOST 6651-2009 A.5	ITPS-68	2-/3-/4-wire	-60 to +180 °C	≤ 0.2 %	500 µA
Ambient temperature influence		≤ 50 ppm/K				
Smallest measuring span		15 K				
Sensor lead wire resistance		Max. 10 Ω per lead for two-wire circuit Max. 30 Ω per lead for three/four-wire circuit				
Measuring range start/end		Freely programmable within the limits in steps of 0.1 K				
Sampling rate		3 or 6 channels: 125 ms				
Input filter		Digital filter, 2nd order; filter constant can be set from 0 to 100.0 s				
Galvanic isolation		See "Galvanic isolation"				

¹ The accuracy value refers to the maximum measuring range. Small measuring ranges lead to reduced linearization accuracy.

Resistance transmitter and resistor/potentiometer

Description	Measuring range	Accuracy ¹	Measuring current
Resistance transmitter	0 to 4000 Ω	≤ 0.1 %	100 μA
Resistance/potentiometer	0 to 400 Ω	≤ 0.1 %	500 μA
	0 to 4000 Ω	≤ 0.1 %	100 μA
Ambient temperature influence	≤ 100 ppm/K		
Connection type			
Resistance transmitter	Three-wire circuit		
Resistance/potentiometer	Two/three/four-wire circuit		
Smallest measuring span	60 Ω		
Sensor lead wire resistance	Max. 10 Ω per cable for two-wire and three-wire circuits		
Resistance values	Freely programmable within the limits in steps of 0.1 Ω		
Sampling rate	3 or 6 channels: 125 ms		
Input filter	Digital filter, 2nd order; filter constant can be set from 0 to 100.0 s		
Galvanic isolation	See "Galvanic isolation"		

¹ The linearization accuracy value refers to the maximum measuring range. Small measuring ranges lead to reduced linearization accuracy.

Voltage, current (standard signals)

Description	Measuring range	Accuracy ¹	Input resistance or burden voltage
Voltage	0 to 70 mV	≤ 0.1 %	> 500 kΩ
	0 to 10 V	≤ 0.05 %	> 500 kΩ
	-10 to +10 V	≤ 0.05 %	> 500 kΩ
	-1 to +1 V	≤ 0.08 %	> 500 kΩ
	0 to 1 V	≤ 0.08 %	> 500 kΩ
Current	4 to 20 mA	≤ 0.1 %	< 2 V
	0 to 20 mA	≤ 0.1 %	< 2 V
Ambient temperature influence	≤ 100 ppm/K		
Smallest measuring span			
Voltage	5 mV		
Current	0.5 mA		
Measuring range start/end			
Voltage	Freely programmable within the limits in steps of 0.01 mV		
Current	Freely programmable within the limits in steps of 0.01 mA		
Deviation below/above the measuring range	According to NAMUR recommendation NE 43 (only current input 4 to 20 mA)		
Sampling rate	3 or 6 channels: 125 ms		
Input filter	Digital filter, 2nd order; filter constant can be set from 0 to 100.0 s		
Galvanic isolation	See "Galvanic isolation"		

¹ The accuracy value refers to the maximum measuring range. Small measuring ranges lead to reduced linearization accuracy.

11 Annex

Measuring circuit monitoring

The device response in the event of a fault is configurable.

Measuring probe	Probe break	Short-circuit	Polarity
Thermocouple	is detected	is not detected	is detected in certain conditions ¹
RTD temperature probe	is detected	is detected	is not detected
Resistance transmitter	is detected	is not detected	is not detected
Resistance/potentiometer	is detected	is not detected	is not detected
Voltage 0 to 70 mV	is detected	is not detected	is detected
Voltage 0 to 10 V	is not detected	is not detected	is detected
Voltage -10 to +10 V	is not detected	is not detected	is not detected
Voltage 0 to 1 V	is detected	is not detected	is detected
Voltage -1 to +1 V	is detected	is not detected	is not detected
Current 0 to 20 mA	is not detected	is not detected	is not detected
Current 4 to 20 mA	is detected	is detected	is detected

¹ dependent on the set characteristic line

11.1.2 Digital inputs (options 1 and 2)

Quantity	0, 6, or 12
Connector number (back of device)	6 and 10
Input	
Level	Logic level "0": < 3.5 V; logic level "1": > 10 V
Sampling rate	125 ms (max. counting frequency: 8 Hz)
Potential-free contact	R _{ON} : < 1 kΩ; R _{OFF} : > 50 kΩ (use of the auxiliary voltage 24 V)
Auxiliary voltage	DC 24 V +10/-15 %, max. 50 mA per option

11.1.3 Digital inputs/outputs (option 3)

Quantity	0 or 12
Connector number (back of device)	14 and 15
Input or output	Individually configurable as input or output
Input	
Level	Logic level "0": < 3.5 V; logic level "1": > 10 V
Sampling rate	125 ms (max. counting frequency: 8 Hz)
Potential-free contact	R _{ON} : < 1 kΩ; R _{OFF} : > 50 kΩ (use of the auxiliary voltage 24 V)
High-speed input	Input 1
Function	Counts each positive edge of the input signal
Max. counting frequency	12.5 kHz
Mark-to-space ratio	30 to 70 % (high-pulse ≥ 30 μs, low-pulse ≥ 30 μs)
Accuracy in flow measurement	0.5 % of measured value; ambient temperature influence: 50 ppm/K
Output	
Output signal	DC 0/24 V +10/-15 %; galvanically isolated
Current	Max. 40 mA per output, max. 100 mA on the whole
Auxiliary voltage	DC 24 V +10/-15 %, max. 100 mA (incl. current of digital outputs)

11.1.4 Analog outputs (options 1 and 2)

Quantity	0, 1, or 2
Connector number (back of device)	6 and 10
Voltage	
Output signal	DC 0 to 10 V
Load resistance	> 500 Ω
Current	
Output signal	DC 0(4) to 20 mA
Load resistance	< 450 Ω
Accuracy	0.5 %
Ambient temperature influence	150 ppm/K

11.1.5 Relay

Quantity	1
Connector number (back of device)	4
Relay (changeover contact)	
Switching capacity	3 A at AC 230 V, resistive load
Contact life	30,000 switching operations at rated load

11 Annex

11.1.6 Interfaces

RS232/RS485	
Quantity	1 (can be switched between RS232 and RS485)
Connector type	SUB-D 9-pin (socket)
Baud rate	9600, 19200, 38400, 115200
Data format	8/1n, 8/1e, 8/1o
Protocol	Modbus RTU as master or slave; barcode scanner
Application	Communication with Modbus master/slave, connection of a barcode scanner
External inputs	Via Modbus master/slave functionality: 24 analog and 24 digital inputs, 10 batch texts, 4 event texts
Ethernet	
Quantity	1
Connector type	RJ45 (socket)
Transfer rate	10 Mbit/s, 100 Mbit/s
Protocol	IPv4; TCP, UDP; DHCP, DNS, HTTP, SMTP, SNMP, Modbus/TCP
Application	Communication with PC (setup program, data archiving, web server), email server, SNMP server, and Modbus master/slave
External inputs	Via Modbus master/slave functionality: 24 analog and 24 digital inputs, 10 batch texts, 4 event texts
Max. cable length	100 m
USB host	
Quantity	1 (on front with cover)
Connector type	A (socket)
Standard	USB 2.0 (high speed)
Application	Exclusively for connecting a USB flash drive (FAT16/FAT32; see accessories)
Max. load current	100 mA
USB device	
Quantity	1 (on the back)
Connector type	Micro-B (socket)
Standard	USB 2.0 (high speed)
Application	To connect to a PC (setup program, PCC/PCA3000)
Max. cable length	5 m

11.1.7 Screen

Type	TFT color screen/touchscreen (resistive) ¹
Size	14.5 cm (5.7")
Resolution	640 × 480 pixels (VGA)
Number of colors	65536
Frame rate	60 Hz (type)
Brightness setting	Adjustable on the device
Screen saver (switch-off)	After waiting period or control signal

¹ TFT color screens can have pixel errors due to technological and/or production-related reasons. Four pixel errors are deemed acceptable for this paperless recorder. They do not constitute an assertion for warranty claims.

11.1.8 Electrical data

Voltage supply	AC 110 to 240 V +10/-15 %, 48 to 63 Hz or AC/DC 20 to 30 V, 48 to 63 Hz (not in conjunction with extra code 970)
Electrical safety	According to DIN EN 61010-1 Overvoltage category II up to 300 V mains voltage, pollution degree 2
Protection rating	I with internal isolation from SELV
Power consumption AC 110 to 240 V AC/DC 20 to 30 V	< 45 VA < 30 VA
Data backup	Internal flash memory
Data buffering	Battery (operating life > 7 years); additionally, storage capacitor for buffering during battery change (buffer time approx. 6 minutes)
Clock	Battery-buffered real-time clock
Electrical connection	On the back via push-in spring-cage terminals
Conductor cross section Wire or strand without ferrule Strand with ferrule 2 × strand with twin ferrule with plastic collar Stripping length	At plug connector 4 and 5 (voltage supply and relay) Min. 0.2 mm ² , max. 2.5 mm ² Min. 0.25 mm ² , max. 2.5 mm ² Min. 0.5 mm ² , max. 1.5 mm ² (both strands with identical cross section) 10 mm
Conductor cross section Wire or strand without ferrule Strand with ferrule Stripping length	At plug connector 6 to 15 (inputs and outputs) Min. 0.14 mm ² , max. 1.5 mm ² Without plastic collar: min. 0.25 mm ² , max. 1.5 mm ² With plastic collar: min. 0.25 mm ² , max. 0.5 mm ² 9 mm
Voltage supply influence	< 0.1 % of the measuring range

11 Annex

11.1.9 Environmental influences

Ambient temperature range	
Storage	-20 to +60 °C
Operation	0 to +50 °C; in conjunction with extra code 970: 0 to +40 °C
Site altitude	Up to 2000 m above sea level
Climatic environmental conditions	According to DIN EN 60721-3 with extended temperature range
Resistance to climatic conditions	≤ 85 % rel. humidity without condensation
Storage	According to class 1K2
Operation	According to class 3K3
Mechanical environmental conditions	According to DIN EN 60721-3
Storage	According to class 1M2
Transport	According to class 2M2
Operation	According to class 3M3
Electromagnetic compatibility (EMC)	According to DIN EN 61326-1
Interference emission	Class A – only for industrial use –
Interference immunity	Industrial requirements

11.1.10 Case

Case type	Flush-mounted case according to DIN IEC 61554 made of zinc-plated steel sheet (indoor use)
Case front	Made of diecast zinc with decor foil
Front frame dimensions	144 mm x 144 mm (front frame depth approx. 8 mm incl. seal)
Mounting depth	119 mm (incl. spring-cage terminals)
Panel cut-out	138 ^{+1.0} mm x 138 ^{+1.0} mm
Panel thickness	2 to 8 mm
Case fastening	In panel, using the four supplied mounting elements
Operating position	Any, with due consideration for the viewing angle of the screen, horizontal ±50°, vertical ±30°
Protection type	According to DIN EN 60529, IP65 on the front, IP20 on the back; in conjunction with extra code 970: IP20 with the carrying case open, IP20D with the carrying case closed
Weight	Max. 1.6 kg

11.1.11 Approvals / approval marks

Approval mark	Testing agency	Certificates/certification numbers	Inspection basis	Valid for
c UL us	Underwriters Laboratories	E201387	UL 61010-1 (3rd Ed.), CAN/CSA-22.2 No. 61010-1 (3rd Ed.)	All types of the flush-mounted device; not in conjunction with extra code 970

11.2 Change of the buffer battery

**CAUTION!**

The device contains a buffer battery that is used for data buffering when the device is in switched off mode or if the power fails. The life of the battery is at least 7 years. A low battery is indicated by the battery pre-alarm ("Battery low"). An empty battery is indicated by the battery alarm ("Battery empty").

If the battery is not changed in time, data may be lost!

The battery must be replaced within 4 weeks after the battery pre-alarm has been triggered.

The battery change must be carried out exclusively by the manufacturer's service department.

For this purpose the device must be sent to the manufacturer.

11 Annex

11.3 China RoHS

 有毒有害物质或元素 Hazardous substances		铅 (Pb)	汞 (Hg)	镉 (Cd)	六价铬 (Cr(VI))	多溴联苯 (PBB)	多溴二苯醚 (PBDE)
		部件名称 Product group: 706520 外壳 Housing (Gehäuse) 过程连接 Process connection (Prozessanschluss) 螺母 Nut (Mutter) 螺钉 Screw (Schraube)	X	○	○	○	○
本表格依据 SJ/T 11364-2014 的规定编制。 (This table is prepared in accordance with the provisions of SJ/T 11364-2014.) O : 表示该有害物质在该部件所有均质材料中的含量均在 GB/T 26572 规定的限量要求以下。 (O: Indicates that said hazardous substance contained in all of the homogeneous materials for this part is below the limit requirement of GB/T 26572.) X : 表示该有害物质至少在该部件的某一均质材料中的含量超出 GB/T 26572 规定的限量要求。 (X: Indicates that said hazardous substance contained in one of the homogeneous materials used for this part is above the limit requirement of GB/T 26572.)							

11.4 Barcode

Initialize the barcode scanner

The barcode scanner must be initialized once before use. Example:

Step	Activity
1	Scan the „Factory Default Settings“ barcode.
2	Scan the „RS-232 Standard“ barcode („Select RS-232 Standard“).

Information and bar codes can be found in the manual of the barcode scanner used.

11.4.1 Batch control



NOTE!

The batch control via barcode scanner requires the appropriate configuration of the paperless recorder. The right „Enter batch texts“ is required.

Display the batch report

This function requires the appropriate display configuration (Configuration > Display > Generally: Barcode -> Batch image = Yes).

Step	Activity
1	Scan the BATCH1 barcode.



BATCH1

The batch report is displayed.

Enter the batch texts

Step	Activity
1	Scan the barcodes for the batch text of each line one after the other (starting from the first line).

All batch lines which were configured for barcode input are successively filled with the scanned text (max. 160 characters). The last line will be overwritten at the next entry.

A dollar sign within a scanned text causes the text following the dollar sign to be entered into the next line. In this way, several lines can be filled with one scan.



NOTE!

The codes for batch control (BATCH1, START, STOP, RESET) can not be read as a batch text.

11 Annex

Reset the texts

Step	Activity
1	Scan the RESET barcode.



The entered batch texts are reset. The default texts are shown and the first line is prepared again for the text input.

The default text is defined in the configuration of the batch line (Configuration > Batch > Batch line: Default text).

Start the batch reporting

Step	Activity
1	Scan the START barcode.



The batch reporting is started.

Stop the batch reporting

Step	Activity
1	Scan the STOP barcode.



The batch reporting is stopped.

In the current batch report, depending on the configuration of the batch line, texts that have been read via barcode are either reset to the default text (Configuration > Batch > Batch line: Delete line = Yes) or maintained.

In the completed batch report, the texts are saved.

11.4.2 Enter event texts and process values

As of device version 02 an event text or process value (external text/analog/digital variables) can be entered by means of specific control characters.

The text or value, which is scanned using a control character, is exclusively used as event text or process value. Afterwards, the system automatically switches back to barcode input for batch control.

Enter text into event list

`%En%` = entry in the event list of group n ($n = 1$ to 4 for group 1 to 4; $n = 0$ for all groups)

Example: `%E1%ABC`



The text "ABC" is entered into the event list of group 1.

Example: `%E0%DEF`

The text "DEF" is entered into the event lists of all groups.

Enter text into external text variable

`%Tn%` = enter as text into the external text variable n ($n = 1$ to 10)

Example: `%T1%ABC`



The text "ABC" is entered into external text variable 1.

The entered text is available in the text selector.

The control character and the following text can also be scanned one after another. To do so, for the first scan process only the control character must be used.

Example for the first scan process: `%T1%`

The next scanned text is interpreted as text for the external text variable 1.

Example for the second scan process: ABC

The text "ABC" is entered into external text variable 1.

Enter float value in external analog variable

`%Fn%` = enter as float value into the external analog variable n ($n = 1$ to 24)

Example: `%F1%447.6`



The float value 447.6 is entered into external analog variable 1.

The entered value is available in the analog selector.

11 Annex

Enter Boolean value in external digital variable:

%Bn% = enter as Boolean value into the external digital variable n (n = 1 to 24)

Example: %B1%1



The Boolean value 1 (TRUE) is entered into the external digital variable 1.

The entered value is available in the digital selector.

A scan process allows several values to be entered into consecutive variables.

Example: %B2%101

The Boolean values 1, 0, 1 are entered as of variable 2 (variable 2 = 1, variable 3 = 0, variable 4 = 1).



JUMO GmbH & Co. KG

Street address:
Moritz-Juchheim-Straße 1
36039 Fulda, Germany
Delivery address:
Mackenrodtstraße 14
36039 Fulda, Germany
Postal address:
36035 Fulda, Germany
Phone: +49 661 6003-0
Fax: +49 661 6003-607
Email: mail@jumo.net
Internet: www.jumo.net

JUMO Instrument Co. Ltd.

JUMO House
Temple Bank, Riverway
Harlow, Essex CM 20 2DY, UK
Phone: +44 1279 63 55 33
Fax: +44 1279 62 50 29
Email: sales@jumo.co.uk
Internet: www.jumo.co.uk

JUMO Process Control, Inc.

6733 Myers Road
East Syracuse, NY 13057, USA
Phone: +1 315 437 5866
Fax: +1 315 437 5860
Email: info.us@jumo.net
Internet: www.jumousa.com