

# JUMO mTRON T

## Measuring, Control, and Automation System Central Processing Unit

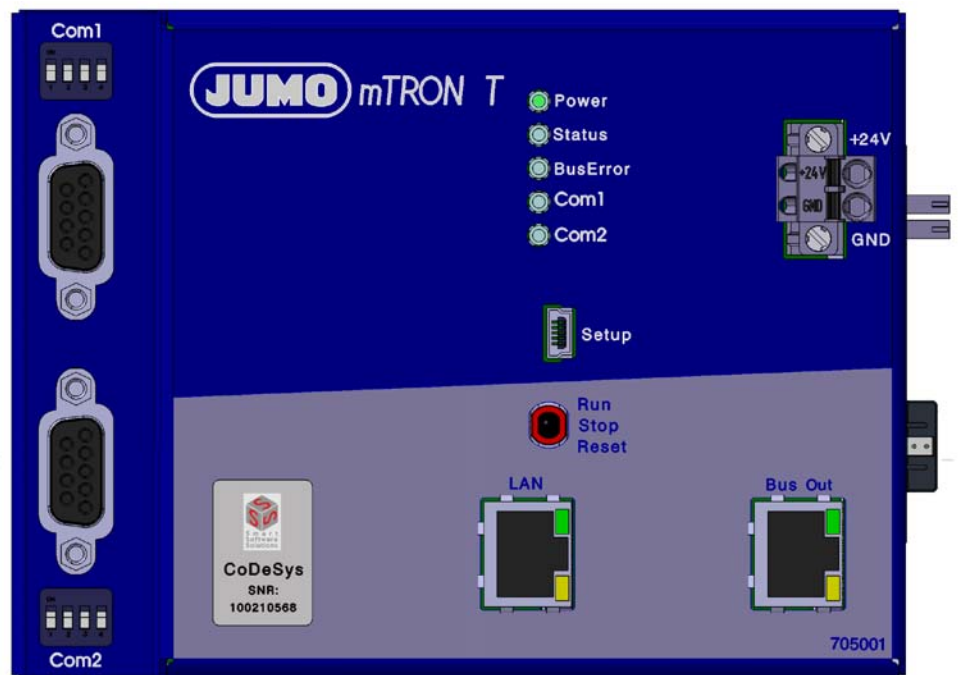

## Interface Description JUMO digiLine



70500106T92Z001K000

V8.00/EN/00657331/2024-12-06



---

<b>1</b>	<b>Introduction</b>	<b>5</b>
1.1	Available technical documentation	5
1.1.1	General information	5
1.1.2	Base units	5
1.1.3	Input/output modules	6
1.1.4	Special modules	6
1.1.5	Operating, visualization, recording	7
1.1.6	Power supply units	7
1.2	Documentation for the sensors	8
1.3	Safety information	9
1.3.1	Warning symbols	9
1.3.2	Note signs	9
1.3.3	Intended use	10
1.3.4	Qualification of personnel	10
1.4	System requirements	11
1.5	Content of this document	11
<b>2</b>	<b>Connection</b>	<b>13</b>
2.1	Installation notes	13
2.2	Serial interfaces	14
2.3	Connecting the sensors	16
2.3.1	Connection without a digiLine Hub	18
2.3.2	Connection with a digiLine Hub	19
2.3.3	Connection diagram	20
2.3.4	Admissible cable length	22
2.3.5	Connection examples for digiLine pH/ORP/T	26
2.3.6	Connection examples for ecoLine O-DO/NTU	28
2.3.7	Connection examples for tecLine ... (types 20263x)	29
2.3.8	Connection example for digiLine Ci/CR (types 20276x) and flowTRANS US W02 (type 406051)	30
2.3.9	Connection example for digiLine O-DO S10 (type 202614) and O-DO H10/H20 (type 202612)	30
2.3.10	Voltage drop calculation (digiLine, ecoLine)	31
<b>3</b>	<b>Configuration</b>	<b>35</b>
3.1	General information	35
3.2	Delivery of export files	35
3.3	Importing export files	36
3.3.1	Importing the interface into the device tree	36
3.3.2	Importing the sensor into the device tree	39
3.3.3	Importing the functional module into the application	41
3.3.4	Configuring the interface	43
3.3.5	Editing the names of variables	46
3.3.6	Configuring functional modules	47
3.3.7	Mapping the outputs	52

---

---

## 1.1 Available technical documentation

The documents specified below are available for the measuring, control, and automation system JUMO mTRON T (previous document number in parentheses).



### NOTE!

Documentation for the automation system JUMO variTRON: See operating manual of the concerning central processing unit JUMO variTRON (705002, 705003, ...).

### 1.1.1 General information

Product	Type of documentation	No.	Printed	PDF file
Measuring, control, and automation system	Data sheet	70500000T10...	-	X
	System manual <sup>1</sup>	70500000T90... (B 705000.0)	X	-
	Setup program manual	70500000T96... (B 705000.6)	-	X
	System description <sup>2</sup>	70500000T98... (B 705000.8)	-	X

<sup>1</sup> Accessory subject to charge

<sup>2</sup> Includes an overview of the purpose and content of all documents

### 1.1.2 Base units

Product	Type of documentation	No.	Printed	PDF file
Central processing unit	Data sheet	70500100T10...	-	X
	Operating manual	70500100T90... (B 705001.0)	-	X
	Modbus interface description	70500100T92... (B 705001.2.0)	-	X
	PROFIBUS-DP interface description	70500103T92... (B 705001.2.3)	-	X
	digiLine interface description	70500106T92...	-	X
	Installation instructions	70500100T94... (B 705001.4)	X	X
	CODESYS OPC server operating manual	70500151T90... (B 705001.5.1)	-	X
	Process engineering application operating manual	70500152T90...	-	X
Operating manual Thyristor power controller (type 70906x; integration in the measuring, control, and automation system)	70500153T90...	-	X	

# 1 Introduction

---

## 1.1.3 Input/output modules

Product	Type of documentation	No.	Printed	PDF file
Multichannel controller module	Data sheet	70501000T10...	-	X
	Operating manual	70501000T90... (B 705010.0)	-	X
	Installation instructions	70501000T94... (B 705010.4)	X	X
Relay module 4-channel	Data sheet	70501500T10...	-	X
	Operating manual	70501500T90... (B 705015.0)	-	X
	Installation instructions	70501500T94... (B 705015.4)	X	X
Analog input module 4-channel	Data sheet	70502000T10...	-	X
	Operating manual	70502000T90... (B 705020.0)	-	X
	Installation instructions	70502000T94... (B 705020.4)	X	X
Analog input module 8-channel	Data sheet	70502100T10...	-	X
	Operating manual	70502100T90... (B 705021.0)	-	X
	Installation instructions	70502100T94... (B 705021.4)	X	X
Analog output module 4-channel	Data sheet	70502500T10...	-	X
	Operating manual	70502500T90...	-	X
	Installation instructions	70502500T94...	X	X
Digital input/output module 12-channel	Data sheet	70503000T10...	-	X
	Operating manual	70503000T90... (B 705030.0)	-	X
	Installation instructions	70503000T94... (B 705030.4)	X	X

## 1.1.4 Special modules

Product	Type of documentation	No.	Printed	PDF file
Router module	Data sheet	70504000T10...	-	X
	Installation instructions	70504000T94... (B 705040.4)	X	X

## 1.1.5 Operating, visualization, recording

Product	Type of documentation	No.	Printed	PDF file
Multifunction panel 840	Data sheet	70506000T10...	-	X
	Operating manual	70506000T90... (B 705060.0)	-	X
	Modbus interface description	70506000T92... (B 705060.2.0)	-	X
	Installation instructions	70506000T94... (B 705060.4)	X	X
Operating panels	Data sheet	70506500T10...	-	X
	Operating manual	70506500T90...	-	X

## 1.1.6 Power supply units

Product	Type of documentation	No.	Printed	PDF file
24 V power supply units	Data sheet	70509000T10...	-	X
	Operating instructions QS3.241		X	-
	Operating instructions QS5.241		X	-
	Operating instructions QS10.241		X	-

# 1 Introduction

## 1.2 Documentation for the sensors

When calibrating, configuring, and connecting sensors, the following documents in particular should be taken into account.

Product	Type of documentation	No.	Printed	PDF file
JUMO digiLine hub (203590) Bus line splitter	Installation instructions	20359000T94...	X	X
JUMO DSM-Software (203599) PC software for management, configuration, and maintenance of digital sensors	Operating manual	20359900T90...	-	X
JUMO digiLine pH (202705/10)	Operating manual	20270510T90...	X	X
JUMO digiLine ORP (202705/20)	Operating manual	20270520T90...	X	X
JUMO digiLine T (202705/30)	Operating manual	20270530T90...	X	X
JUMO digiLine Ci (202760, 202761)	Operating manual	20276110T90...	X	X
JUMO digiLine CR (202762, 202763)	Operating manual	20276310T90...	X	X
JUMO ecoLine O-DO (202613)	Operating manual	20261300T90... (B 202613.0)	X	X
JUMO ecoLine NTU (202670)	Operating manual	20267000T90... (B 202670.0)	X	X
JUMO tecLine Cl2 (202630)	Operating manual	20263000T90...	X	X
JUMO tecLine TC (202631)	Operating manual	20263100T90...	X	X
JUMO tecLine ClO2 and O3 (202634)	Operating manual	20263400T90...	X	X
JUMO tecLine H2O2 and PAA (202636)	Operating manual	20263600T90...	X	X
JUMO tecLine Br2 (202637)	Operating manual	20263700T90...	X	X
JUMO digiLine O-DO S10 (202614)	Operating manual	20261400T90...	X	X
JUMO digiLine O-DO H10/H20 (202612)	Operating manual	20261200T90...	X	X
JUMO flowTRANS US W02 (406051)	Operating manual	40605106T90...	-	X
	Brief instructions	40605106T97...	X	X

## 1.3 Safety information

### 1.3.1 Warning symbols



#### **DANGER!**

This symbol indicates that **personal injury caused by electrical shock** may occur if the respective precautionary measures are not carried out.



#### **WARNING!**

This symbol in connection with the signal word indicates that personal injury may occur if the respective precautionary measures are not carried out.



#### **CAUTION!**

This symbol in connection with the signal word indicates that **damage to assets or data loss** will occur if the respective precautionary measures are not taken.



#### **CAUTION!**

This symbol indicates that **components could be destroyed** by electrostatic discharge (ESD = Electro Static Discharge) if the respective cautionary measures are not taken. Only use the ESD packages intended for this purpose to return device inserts, assembly groups, or assembly components.



#### **READ DOCUMENTATION!**

This symbol – placed on the device – indicates that the associated **device documentation has to be observed**. This is necessary to recognize the kind of the potential hazards as well as the measures to avoid them.

### 1.3.2 Note signs



#### **NOTE!**

This symbol refers to **important information** about the product, its handling, or additional use.



#### **REFERENCE!**

This symbol refers to **further information** in other sections, chapters, or manuals.



#### **FURTHER INFORMATION!**

This symbol is used in the tables and refers to **further information** in connection with the table.



#### **DISPOSAL!**

This device and the batteries (if installed) must not be disposed in the garbage can after use! Please ensure that they are disposed properly and in an **environmentally friendly manner**.

# 1 Introduction

---

## 1.3.3 Intended use

The measuring, control, and automation system is intended for use in an industrial environment, as specified in the technical data of the individual system modules. Other uses beyond those defined are not viewed as intended uses.

The modules are manufactured in compliance with the relevant standards and directives as well as the applicable safety regulations. Nevertheless, improper use may lead to personal injury or material damage.

To avoid dangers, the modules may only be used:

- for the intended use
- when in good order and condition
- When taking into account the technical documentation provided

Even if a module is used correctly and according to the intended use, it may still pose application-related dangers, for example as the result of missing safety devices or incorrect settings.

To avoid incorrect settings, this manual contains relevant safety information and warnings. These must be complied with.

## 1.3.4 Qualification of personnel

This document contains the information required to ensure that the measuring, control, and automation system described is used as intended.

It is intended for technically qualified personnel who have received special training and have the appropriate knowledge in the field of automation technology (measuring and control technology).

Understanding and technically correct observance of the safety information and warnings contained in the supplied technical documentation are prerequisites for safe startup as well as safety during operation. Only qualified personnel have the required specialist knowledge to correctly interpret and implement the safety information and warnings contained in this document in specific situations.

## 1.4 System requirements

The measuring, control, and automation system supports the connection of up to 62 sensors of types JUMO digiLine pH/ORP/T (types 202705; sensors with detachable digiLine electronics), JUMO digiLine Ci/CR (types 20276x), JUMO ecoLine NTU (type 202613) and O-DO (type 202670), JUMO tecLine (types 20263x), JUMO digiLine O-DO S10/H10/H20 (types 202614/202612) as well as JUMO flowTRANS US W02 (406051). The sensors are connected to a serial interface (RS422/485) in the central processing unit via an intelligent, bus-compatible connection system. Up to 31 sensors can be connected to each of the two optional interfaces (Com1, Com2).

### Software

The sensors can be connected to the measuring, control, and automation system from CODESYS version 3.5 SP3 patch 9 and above (from system version 02).

As of system version 05, CODESYS version 3.5 SP10 patch 0 is applied.

When selecting the so-called Export files (ZIP files), a distinction must be made between the applied CODESYS version.

⇒ Chapter 3.2 "Delivery of export files", page 35

### Hardware

The central processing unit must be equipped with at least one RS422/485 Modbus RTU serial interface (Com1 or Com2) (order code 54).

### Extra code

In order to integrate the sensors into the measuring, control, and automation system, the central processing unit requires the extra code 224 (PLC activation according to IEC 61131-3 CODESYS V3.5).

## 1.5 Content of this document



### NOTE!

JUMO digiLine, JUMO ecoLine, JUMO tecLine, and JUMO flowTRANS are registered trademarks of JUMO GmbH & Co. KG, 36039 Fulda, Germany. Instead of the full trademarks, only the terms "digiLine", "ecoLine", and "tecLine" are used in the following sections of this document.

This document describes how to connect the sensors. It also describes their configuration, provided it must be performed within the measuring, control, and automation system.

All further information can be found in the technical documentation for the sensors used and any other components (digiLine Hub, power supply unit).

# 1 Introduction

---

### 2.1 Installation notes

**NOTE!**

These installation notes apply for the entire measuring, control, and automation system and, on some occasions, are only applicable for a specific module. The respective connection diagram shows the context.

**Requirements for the personnel**

- Work on the modules must only be carried out to the extent described and, like the electrical connection, only by qualified personnel.
- Before plugging and unplugging connection cables ensure that the person performing the work is electrostatically discharged (e.g. by touching grounded metallic parts).

**Cables, shielding, and grounding**

- When selecting the cable material, when installing, and when performing the electrical connection of the module, the regulations of DIN VDE 0100 "Erection of power installations with rated voltages up to 1000 V" and the respective national regulations (e.g. on the basis of IEC 60364) are to be observed.
- Certain cables must be heat resistant up to at least 80 °C at maximum load. The relevant instructions in the connection diagram of the affected modules must be observed.
- Route input, output, and supply cables separately and not parallel to one another.
- Only use shielded and twisted probe and interface cables. Do not route the lines close to current-carrying components or cables.
- For temperature probes, ground the shielding on one side in the control cabinet.
- Do not perform loopthroughs on the grounding cables, but route the cables individually to a shared grounding point in the control cabinet; in doing so, ensure that the cables are as short as possible.  
Ensure that the equipotential bonding is correct.
- When connecting the device to an external PELV electrical circuit, the existing internal SELV electrical circuit becomes a PELV electrical circuit whereby the protection against electrical shock is provided through double/reinforced insulation and voltage limitation – but here no connection to the protective ground is required.

## 2 Connection

---

### Electrical safety

- Isolate power supply units from the voltage supply on the primary side if there is a risk of touching parts with dangerous electrical voltage (e.g. 230 V) in the course of work.
- The fuse rating of the power supply units on the primary side should not exceed a value of 10 A (inert).
- With modules with relay or solid state relay outputs, the load circuits can be operated with a dangerous electrical voltage (e.g. 230 V). Disconnect load circuits from the voltage supply during installation/dismounting and electrical connection.
- In order to prevent the destruction of the relay or solid state relay outputs in the event of an external short circuit in the load circuit, the load circuit should be fused to the maximum admissible output current.
- The modules are not suitable for installation in areas with an explosion hazard.
- In addition to a faulty installation, incorrectly set values on the module could also impair the correct function of the following process. Therefore, ensure that safety devices independent of the module (e.g. overpressure valves or temperature limiters/monitors) are available and that it is only possible for qualified personnel to define settings. Please observe the corresponding safety regulations in this context.

### References to other information

- The electromagnetic compatibility meets the standards and regulations cited in the technical data.
- The USB device interface and voltage supply in the central processing unit 705001 are **not** electrically isolated. In general, please observe the specifications regarding electrical isolation.

## 2.2 Serial interfaces

The central processing unit can be equipped with either one or two serial interfaces as optional extras (Com1 and Com2). These are available as additional modules (RS232, RS422/485).

At least one RS422/485 interface is required to connect the sensors; in this case, the interface is used as an RS485 interface (see interface assignment).



#### NOTE!

The type designation on the central processing unit's nameplate provides information on which optional interfaces were assembled **ex-works**.

Information on this can be found in the chapter "Identifying the device version" in the operating manual or the installation instructions of the central processing unit (the installation instructions are included in the scope of delivery of the central processing unit).



#### NOTE!

Optional interfaces can also be added **by the user**.

Information on this can be found in the chapter "Retrofitting interfaces" in the operating manual or the installation instructions of the central processing unit (the installation instructions are included in the scope of delivery of the central processing unit).

## Front view of the central processing unit

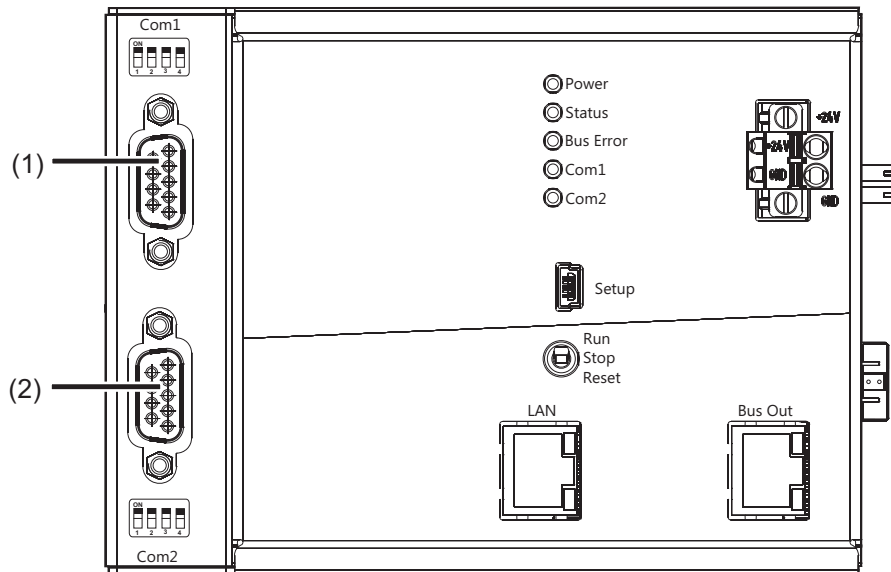

- (1) Com1 serial interface (9-pin)
- (2) Com2 serial interface (9-pin)

## Interface assignment

Connection	Description	Connection element		
Serial interface (RS232)	Com1, Com2		2 RxD	Received data
			3 TxD	Transmission data
			5 GND	Ground
Serial interface (RS422)	Com1, Com2		3 TxD+	Transmission data +
			4 RxD+	Received data +
			5 GND	Ground
Serial interface (RS485)	Com1, Com2		8 TxD-	Transmission data -
			9 RxD-	Received data -
			3 TxD/RxD+	Transmission/received data +
			5 GND	Ground
			8 TxD/RxD-	Transmission/received data -



### NOTE!

A twisted connecting cable with shielding must be used to connect the RS422/485 interface. To avoid transmission errors, only the signals listed above may be connected.

## 2 Connection

---

### Internal terminating resistors

The internal terminating resistors for the Com1 and Com2 interfaces are only relevant for RS422/485.

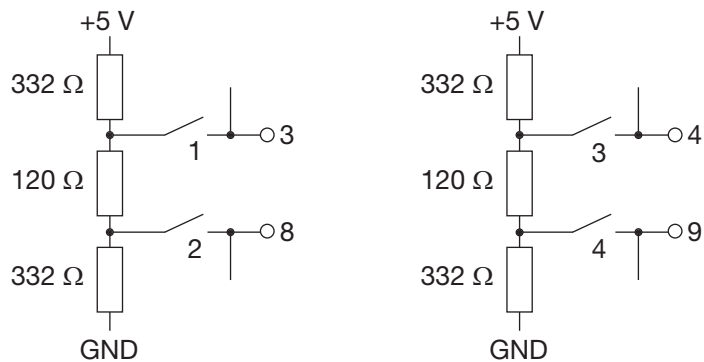

The terminating resistors are deactivated per default. To activate them, DIP switches 1 to 4 for the relevant interface must be pushed upward using a suitable tool such as a ballpoint pen (ON position).

The following figure shows the position of the DIP switches when the terminating resistors are activated.

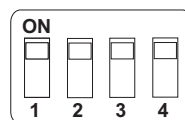

## 2.3 Connecting the sensors

Prepared connecting cables with 5-pin M12 plug connectors are normally utilized to connect the sensors.

M12 digiLine master connecting cables in various lengths are available as accessories to connect the devices to the central processing unit (master) and the voltage supply. These connecting cables have one open end (with ferrules) to enable connection to screw and spring-cage terminals. A 5-pin M12 plug connector is located at the other end of the connecting cable.

A 9-pin D-sub connector is required to connect the device to the central processing unit's RS485 interface; the open end of the signal cable (RS485 A and RS485 B) and GND must be connected to this connector in a suitable manner (e.g. using a D-sub connector with terminals). The components needed depends on the local conditions.

Ideally, the sensors are connected to the central processing unit via the digiLine Hub. This hub is a passive distributor with various options for supplying voltage. Alternatively, they can be connected directly using Y-adapters and connecting cables.

The admissible cable length (total bus length, length of stub lines) and the admissible number of sensors (max. 31) depend on several factors.

### M12 plug connector

5-pin variant, A-coded

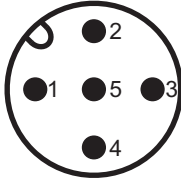
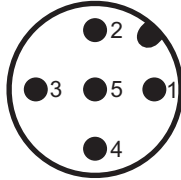
Pin	Assignment	Socket	Connector
1	+5 V		
2	+24 V		
3	GND		
4	RS485 B (TxD/RxD-)		
5	RS485 A (TxD/RxD+)		

### M12 digiLine master connecting cable

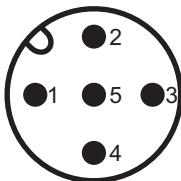
Pin	Assignment	Socket	Wire color
1	+5 V		Brown (BN)
2	+24 V		White (WH)
3	GND		Blue (BU)
4	RS485 B (TxD/RxD-)		Black (BK)
5	RS485 A (TxD/RxD+)		Gray (GY)



#### NOTE!

GND is the shared ground for the +5 V and +24 V voltage supply for the sensors. The RS485 A and RS485 B signal wires and the GND must be connected to the corresponding pins in a 9-pin D-sub connector.

## 2 Connection

### 2.3.1 Connection without a digiLine Hub

The following example shows two sensors connected to the central processing unit. Voltage is supplied by a separate power supply unit DC 5 V (5.3 V).

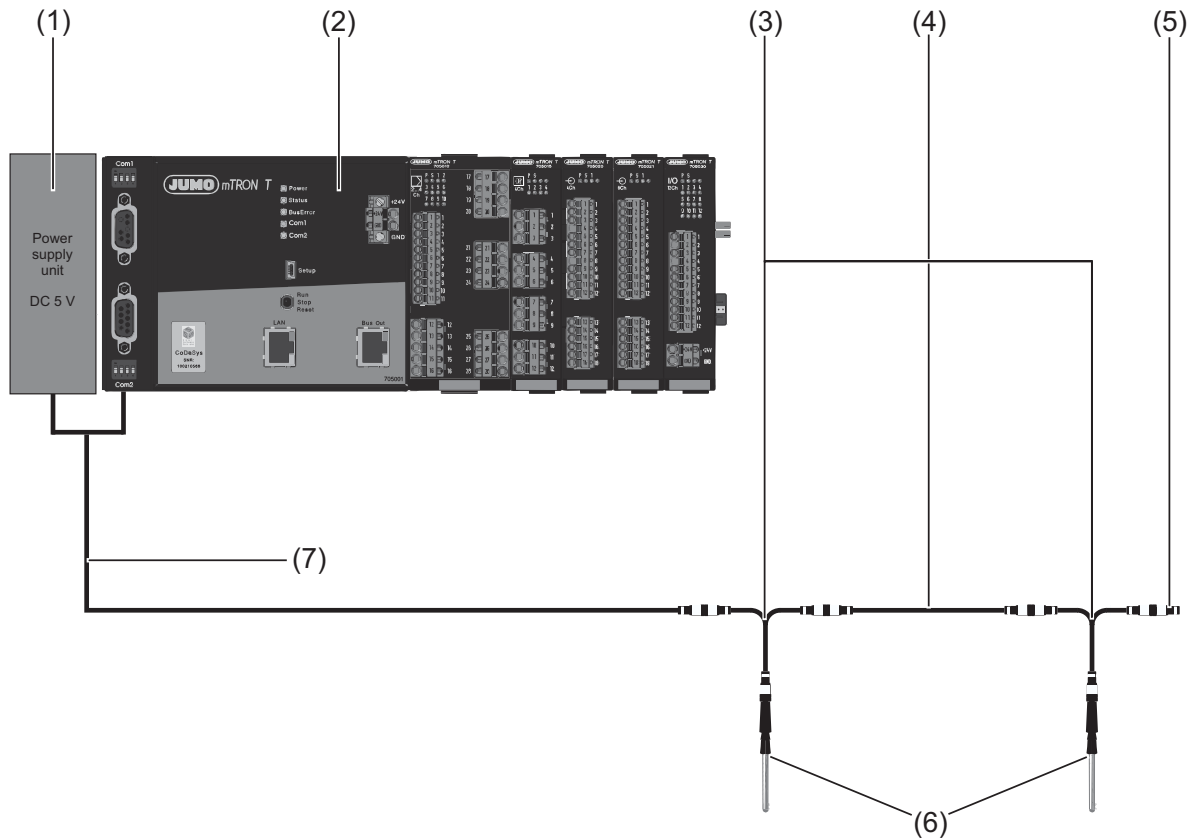

- (1) Regulated power supply unit DC 5 V (5.3 V) for supplying power to the sensors
- (2) Central processing unit with RS485 interface as digiLine master (Modbus master)
- (3) Y-adapter (T-piece), 5-pin with 2× M12 sockets and 1× M12 connector, each of which is A-coded
- (4) M12 connecting cable, 5-pin, A-coded
- (5) M12 terminating connector, 5-pin for bus termination (120 Ω)
- (6) Sensors with 5-pin M12 connections; with as short a stub line as possible
- (7) M12 digiLine master connecting cable for establishing a connection to the voltage supply and the central processing unit's RS485 interface

### 2.3.2 Connection with a digiLine Hub

The digiLine Hub is a passive distributor for sensors connected in a star formation. Several hubs can be cascaded so that up to 31 sensors can be connected.

The distributor is equipped with an M12 input and four M12 outputs (all 5-pin). A 2-pin spring-cage terminal is installed in the distributor for connection to a separate DC 24 V voltage supply. The cable coming from the voltage supply is inserted into the distributor using a cable fitting.

Voltage can be supplied to the sensors in a variety of ways:

- Variant (switch position) 1: +24 V and +5.3 V supplied through M12 input
- Variant (switch position) 2: +24 V supplied through M12 input, +5.3 V generated internally
- Variant (switch position) 3: +24 V supplied through 2-pin terminal, +5.3 V generated internally

⇒ digiLine Hub installation instructions

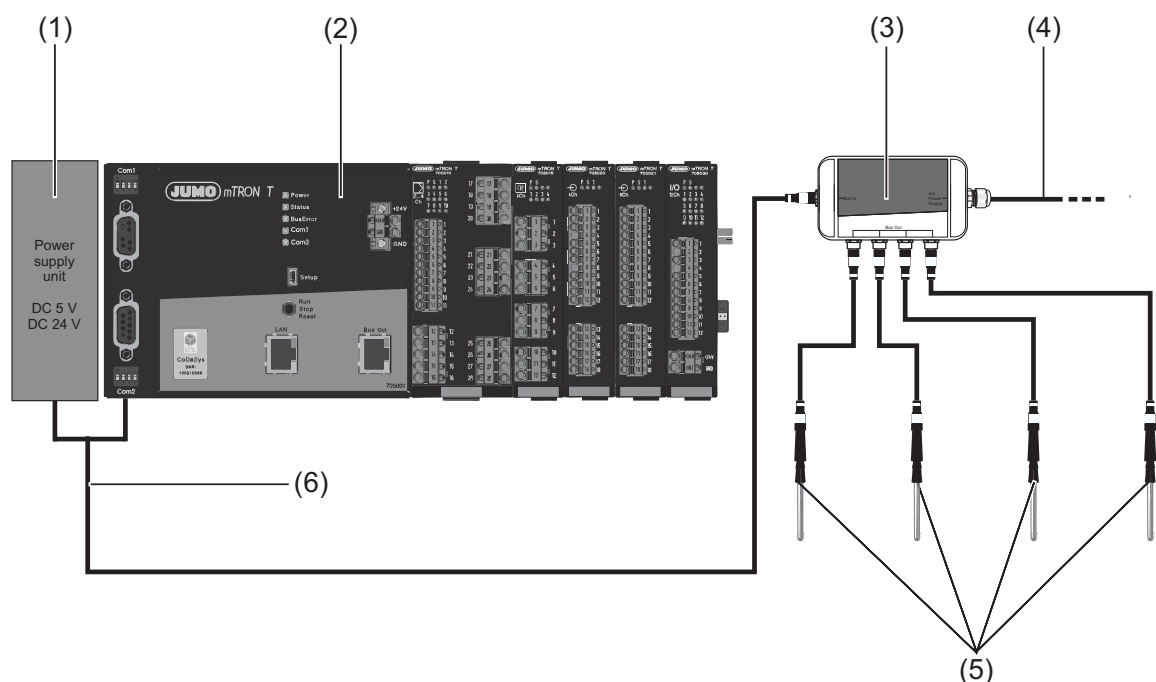

- (1) Regulated DC 24 V and/or DC 5 V power supply unit (5.3 V) for voltage supply (variant 1 or 2)
- (2) Central processing unit with RS485 interface as digiLine master (Modbus master)
- (3) digiLine Hub
- (4) Option for connecting separate DC 24 V voltage supply (variant 3)
- (5) Sensors with 5-pin M12 connections; with as short a stub line as possible
- (6) M12 digiLine master connecting cable for establishing a connection to the voltage supply and the central processing unit's RS485 interface

## 2 Connection

### 2.3.3 Connection diagram

The following diagram illustrates the connection of an M12 digiLine master connecting cable with its open wire ends to the measuring, control, and automation system.

The connection is made using a special interface module (terminal block with screw terminals) which is available as an accessory. The interface module is used primarily to connect the data line (TxD/RxD+, TxD/RxD-) and ground (GND) to a 9-pin D-sub male connector. This connector is linked to one of the serial interfaces of the central processing unit (CPU) using a D-sub connecting cable which also is available as an accessory in different lengths.

The other wires (5 V, 24 V, GND) are also connected via the interface module. This allows them to be individually connected to the power supply units (conductor cross section  $0.25 \text{ mm}^2$ ). The shield of the M12 digiLine master connecting cable has to be connected to one of the two ground terminals of the interface module.

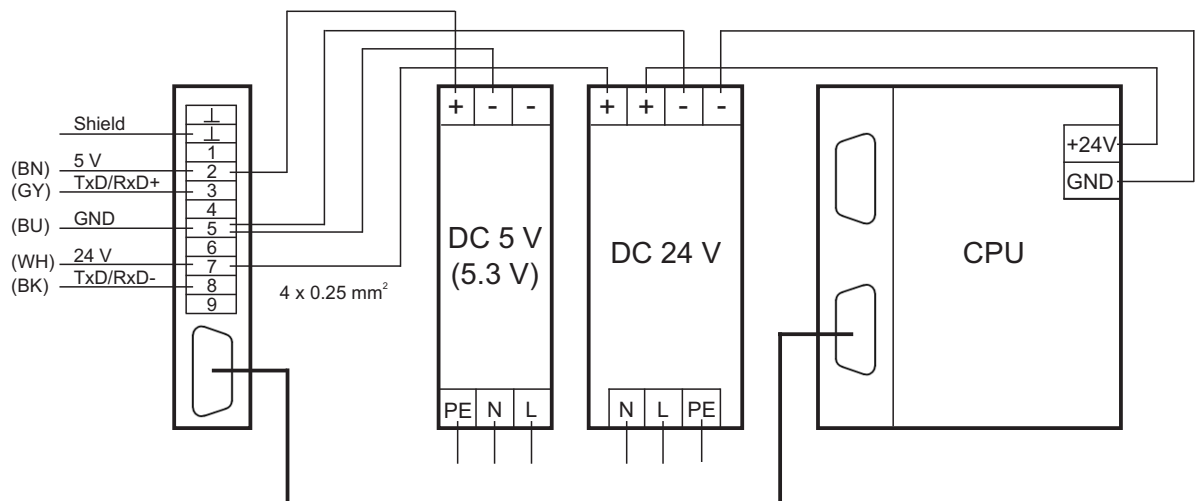

#### NOTE!

The DC 5 V power supply unit must be set to 5.3 V to compensate for the voltage drop between the power supply unit and the sensor (see Chapter 2.3.10 "Voltage drop calculation (digiLine, ecoLine)", page 31).



#### NOTE!

In the example above the DC 24 V power supply unit of the measuring, control, and automation system is also used to supply the sensors or the digiLine hub (observe power consumption). The interface's galvanic isolation is then lost. A separate DC 24 V power supply unit is required if isolation is needed. In this case, the secondary-side terminals of the two DC 24 V power supply units must not be connected.



#### CAUTION!

The sensors are not protected against reverse voltage and overvoltage. There is a risk of damage to the sensors.

Before connecting the sensors, be sure to pay attention to the correct polarity of the supply voltages DC 5.3 V and DC 24 V as well as to the voltage values.

### Accessories

The following components are available as accessories:

- M12 digiLine master connecting cable for 705001, 5-pin, A-coded, length 1.5 m  
Part no. 00665529
- M12 digiLine master connecting cable for 705001, 5-pin, A-coded, length 5 m  
Part no. 00665539
- M12 digiLine master connecting cable for 705001, 5-pin, A-coded, length 10 m  
Part no. 00665547
- Interface module for digiLine master connecting cable, with screw terminals and 9-pin D-sub female connector, for DIN rail mounting  
Part no. 00665752
- D-sub connecting cable (round), 9-pin female and male connector, length 1 m  
Part no. 00665749
- D-sub connecting cable (round), 9-pin female and male connector, length 2 m  
Part no. 00665750
- D-sub connecting cable (round), 9-pin female and male connector, length 3 m  
Part no. 00665751
- Power supply unit DC 5 V (5.0 to 5.5 V), 3 A; input voltage AC 100 to 240 V;  
for DIN rail mounting  
Part no. 00665745
- Power supply unit DC 24 V, 5 A (type 705090/05-33)  
Part no. 00569515
- Power supply unit DC 24 V, 10 A (type 705090/10-33)  
Part no. 00569516

Moreover, additional components, such as M12 connecting cables and Y-adapters, are available as accessories. The part numbers of these components can be found in the documentation for the sensors (see Chapter 1.2 "Documentation for the sensors", page 8).

## 2 Connection

---

### 2.3.4 Admissible cable length

The maximum admissible cable length (bus length, length of stub lines) depends on the type of voltage supply and bus topology.

#### 5.3 V voltage supply through separate power supply unit

The 5.3 V voltage is supplied through the digiLine Hub's M12 input (switch position 1).

The information also applies for connections without the digiLine Hub, i.e. using Y-adapters.

##### Line topology:

Sensor	Max. bus length	Max. length of stub lines	Max. number of sensors	Comment
digiLine pH/ORP/T	100 m (Depends on the number and distribution of sensors on the bus)	10 m (Stub line from the digiLine Hub or Y-adapter to the sensor)	31	Bus termination is recommended at both ends; max. admissible voltage drop between supply (5.3 V) and the last sensor: 1.0 V
ecoLine O-DO ecoLine NTU	100 m (Depends on the number and distribution of sensors on the bus)	10 m (Stub line from the digiLine Hub or Y-adapter to the sensor)	31	Bus termination is not permissible; max. admissible voltage drop between supply (5.3 V) and the last sensor: 0,3 V

For mixed operation of digiLine pH/ORP/T sensors together with sensors of type ecoLine O-DO/NTU, a bus termination is not permissible (not even at the master)!

##### Star topology:

Sensor	Maximum length per branch	Max. number of sensors	Comment
digiLine pH/ORP/T	50 m	31	Bus termination is not permissible
ecoLine O-DO ecoLine NTU	50 m	31	Bus termination is not permissible

### 5.3 V voltage supply through the digiLine Hub

The digiLine Hub is supplied with 24 V voltage (through the M12 input or the separate voltage input). The 5.3 V voltage is generated in the digiLine Hub (switch position 2 or 3).

#### Line topology:

Sensor	Max. bus length	Max. length of stub lines	Max. number of sensors	Comment
digiLine pH/ORP/T	Min. 200 m	10 m (Stub line from the digiLine Hub to the sensor)	31	Bus termination is recommended at both ends
ecoLine O-DO ecoLine NTU	min. 200 m	10 m (Stub line from the digiLine Hub to the sensor)	31	Bus termination is not permissible

For mixed operation of digiLine pH/ORP/T sensors together with sensors of type ecoLine O-DO/NTU, a bus termination is not permissible (not even at the master)!

#### Star topology:

Sensor	Maximum length per branch	Max. number of sensors	Comment
digiLine pH/ORP/T	50 m	31	Bus termination is not permissible
ecoLine O-DO ecoLine NTU	50 m	31	Bus termination is not permissible

## 2 Connection

---

### 24 V voltage supply for tecLine sensors (types 20263x)

The 24 V voltage is supplied through the digiLine Hub's M12 input or the separate voltage input (switch position 1, 2, or 3).

The information also applies for connections without the digiLine Hub, i.e. using Y-adapters.

#### Line topology:

Sensor	Max. bus length	Max. length of stub lines	Max. number of sensors	Comment
tecLine ... (types 20263x)	100 m (Depends on the number and distribution of sensors on the bus)	10 m (Stub line from the digiLine Hub or Y-adapter to the sensor)	31	Bus termination is recommended at both ends; max. admissible voltage drop between supply (24 V) and the last sensor: 1.5 V

For mixed operation of tecLine sensors (types 20263x) together with sensors of type ecoLine O-DO/NTU, a bus termination is not permissible (not even at the master)!

#### Star topology:

Sensor	Maximum length per branch	Max. number of sensors	Comment
tecLine ... (types 20263x)	50 m	31	Bus termination is not permissible

### 24 V voltage supply for sensors digiLine Ci/CR (types 20276x) and flowTRANS US W02 (type 406051)

The 24 V voltage is supplied exclusively through the digiLine Hub's separate voltage input (switch position 3).

The use of Y-adapters is not permitted.

#### Line topology:

Sensor	Max. bus length	Max. length of stub lines	Max. number of sensors	Comment
digiLine Ci/CR (types 20276x) flowTRANS US W02 (type 406051)	min. 200 m	10 m (Stub line from the digiLine Hub to the sensor)	31	Bus termination is recommended at both ends

For mixed operation together with sensors of type ecoLine O-DO/NTU, a bus termination is not permissible (not even at the master)!

### 24 V voltage supply for digiLine sensors O-DO S10 (type 202614) and O-DO H10/H20 (type 202612)

The 24 V voltage is supplied through the digiLine Hub's M12 input or the separate voltage input (switch position 1, 2, or 3). When feeding via the M12 input and using several hubs, the voltage drops and the total current must be observed. If necessary, an intermediate supply via the separate voltage input of individual hubs is required (switch position 3).

The use of Y-adapters is not permitted.

#### Line topology:

Sensor	Max. bus length	Max. length of stub lines	Max. number of sensors	Comment
digiLine O-DO S10 (type 202614) digiLine O-DO H10/H20 (type 202612)	min. 200 m	10 m (Stub line from the digiLine Hub to the sensor)	31	Bus termination required at master; bus termination is recommended at both ends  digiLine O-DO H10/H20: Observe the instructions for grounding in the operating manual!

For mixed operation together with sensors of type ecoLine O-DO/NTU, a bus termination is not permissible (not even at the master)!

## 2 Connection

### 2.3.5 Connection examples for digiLine pH/ORP/T

The following examples show a few scenarios for using sensors of types digiLine pH/ORP/T.

#### Line topology without a digiLine Hub with 5.3 V voltage supply through separate power supply unit

Sensors connected via Y-adapter, 2 groups of 3 sensors, 10 m distance between both groups, 20 m connecting cable to the master (incl. M12 digiLine master connecting cable), bus termination on both ends (T), a total of 6 sensors:

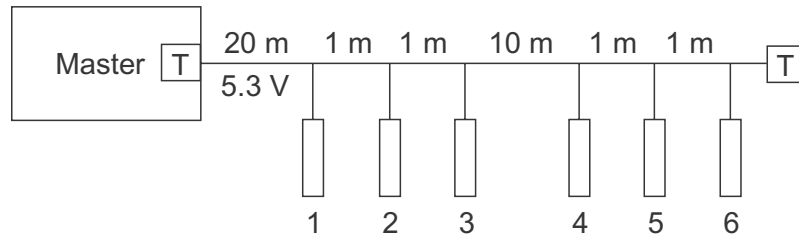

#### Star topology with a digiLine Hub and 5.3 V voltage supply through separate power supply unit

Two digiLine Hubs form one point (short connection between the hubs), 3 long stub lines each (50 m) with 3 sensors each (connected by Y-adapters), 20 m connection cable to the master (including M12 digiLine master connecting cable), no bus termination, a total of 18 sensors:

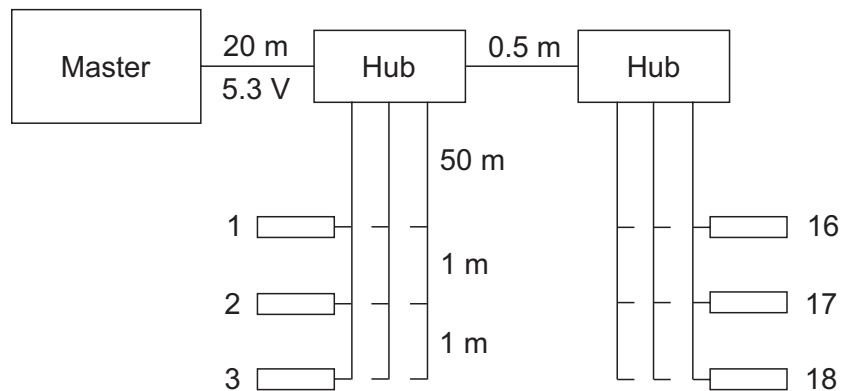

### Line topology with a digiLine Hub with an internal 5.3 V voltage supply

Four digiLine Hubs form a line structure with 50 m between each hub, each with 3 short stub lines (10 m) with up to 3 sensors (connected by Y-adapters), 50 m connecting cable to the master (including M12 digiLine master connecting cable), the 5.3 V voltage is generated in the hubs (24 V supplied through M12 input), bus termination (T) only at the start (central processing unit), a total of 31 sensors:

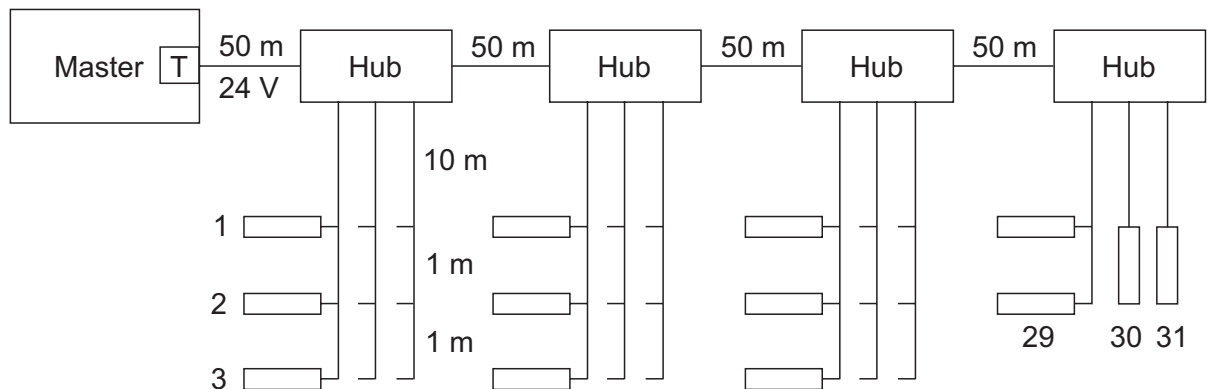

#### NOTE!

The line length and number of sensors depend primarily on whether the required supply voltage is still available at the last sensor. In general, we recommend using digiLine Hubs where the 5.3 V voltage should be generated in the hub (variants 2 and 3).

## 2 Connection

---

### 2.3.6 Connection examples for ecoLine O-DO/NTU

The following examples show a few scenarios for using sensors of types ecoLine O-DO/NTU.

#### Line topology without a digiLine Hub with 5.3 V voltage supply through separate power supply unit

Sensors connected via Y-adapter, 3 groups of 2 sensors, 10 m distance between all groups, 10 m connecting cable to the master (incl. M12 digiLine master connecting cable), no bus termination, a total of 6 sensors:

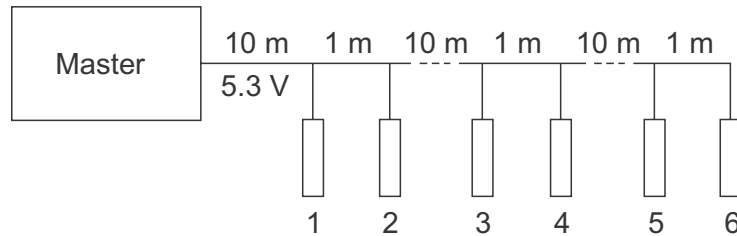

#### Star topology with a digiLine Hub and 5.3 V voltage supply through separate power supply unit

Two digiLine Hubs form one point (short connection between the hubs), 3 long stub lines each (50 m) with 1 sensor each, 10 m connection cable to the master (including M12 digiLine master connecting cable), no bus termination, a total of 6 sensors:

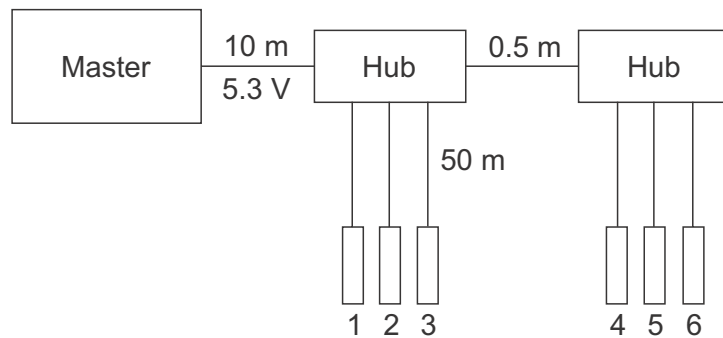

### Line topology with a digiLine Hub with an internal 5.3 V voltage supply

Three digiLine Hubs form a line structure with 50 m between each hub, short stub lines (10 m) to the Y-adapters and to the sensors (10 m), 100 m connecting cable to the master (including M12 digiLine master connecting cable), the 5.3 V voltage is generated in the hubs (24 V supplied through M12 input), no bus termination, a total of 31 sensors:

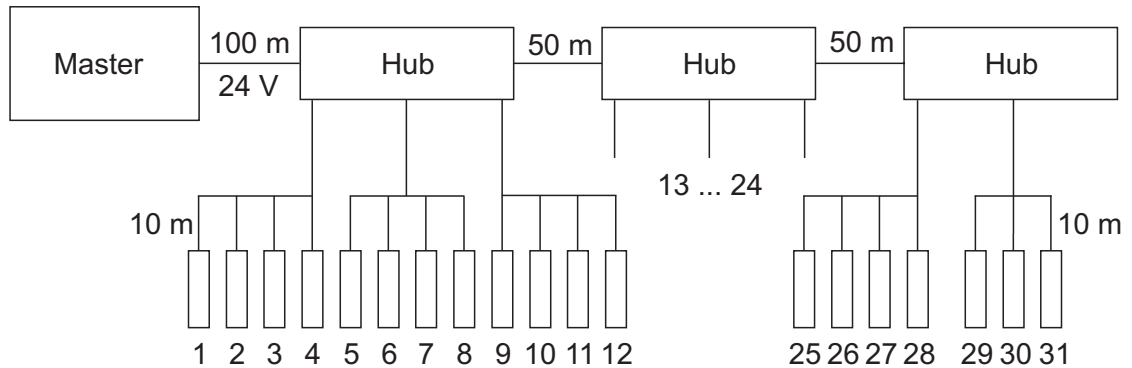

#### NOTE!

The line length and number of sensors depend primarily on whether the required supply voltage is still available at the last sensor. In general, we recommend using digiLine Hubs where the 5.3 V voltage should be generated in the hub (variants 2 and 3).

### 2.3.7 Connection examples for tecLine ... (types 20263x)

The digiLine pH/ORP/T connection examples apply in principle to the tecLine sensors (types 20263x) as well.

⇒ Chapter 2.3.5 "Connection examples for digiLine pH/ORP/T", page 26

In contrast to the 5.3 V supply voltage mentioned there, the tecLine sensors (types 20263x) operate with a supply voltage of 24 V (minimum voltage: see nameplate). If digiLine hubs are employed, an intermediate feed-in of the supply voltage can be used if necessary (variant 3: 24 V supplied through 2-pin terminal).

## 2 Connection

### 2.3.8 Connection example for digiLine Ci/CR (types 20276x) and flowTRANS US W02 (type 406051)

Due to their high current consumption, the sensors digiLine Ci/CR (types 20276x) and flowTRANS US W02 (type 406051) may exclusively be connected using digiLine Hubs.

Each hub is to be supplied separately with the DC 24 V voltage (variant 3: 24 V supplied through 2-pin terminal). If necessary, separate power supply units and connecting cables with a sufficiently large wire cross-section have to be used.

Only one single sensor may be connected to each output of the hub. The maximum permissible length of the stub line between hub and sensor is 10 m.

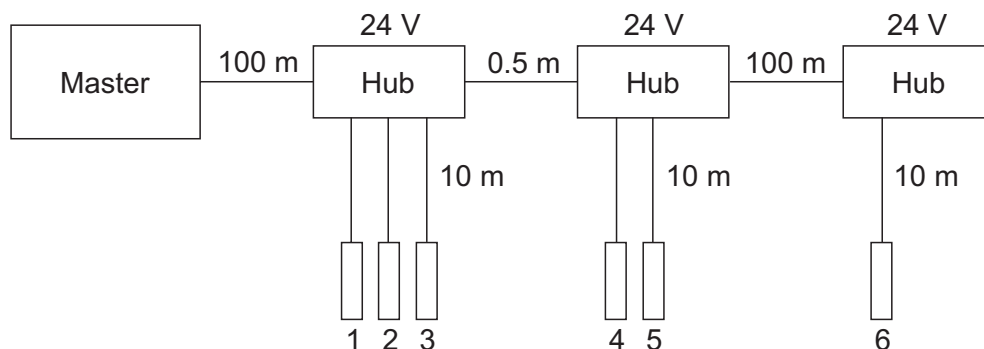

### 2.3.9 Connection example for digiLine O-DO S10 (type 202614) and O-DO H10/H20 (type 202612)

The digiLine sensors O-DO S10 (type 202614) and O-DO H10/H20 (type 202612) are connected exclusively using digiLine hubs.

The DC 24 V voltage is supplied through the digiLine Hub's M12 input or the separate voltage input (variant 1, 2, or 3). When feeding via the M12 input and using several hubs, the voltage drops and the total current must be observed. If necessary, an intermediate supply via the separate voltage input of individual hubs is required (variant 3).

Only one single sensor may be connected to each output of the hub. The maximum permissible length of the stub line between hub and sensor is 10 m.

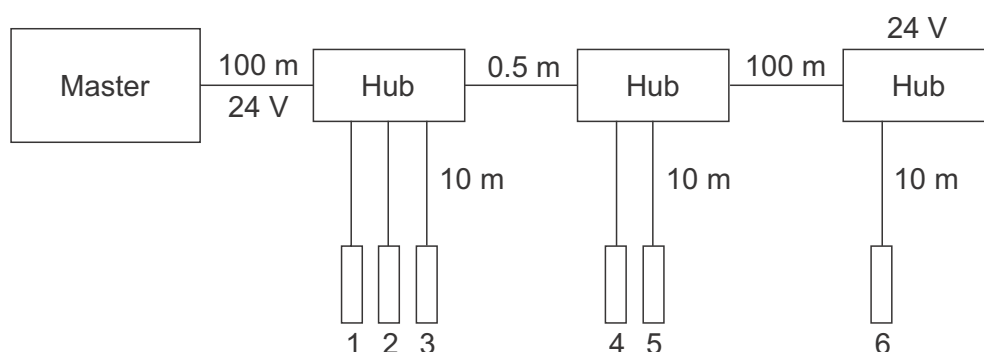

### 2.3.10 Voltage drop calculation (digiLine, ecoLine)

In the case of a digiLine bus with line topology (Y-adapter or digiLine hub with 5.3 V through a separate power supply unit) there is inevitably a voltage drop between the supply voltage feed-in and each sensor. The amount of the voltage drop depends on the sensor type, the number of sensors, the length of the bus, and the distribution of the sensors on the bus. Since each sensor requires a minimum voltage for proper operation, the voltage drop needs to be considered in the planning.

In the following description the calculation of the voltage drop is shown with the help of an example.

#### Bus structure

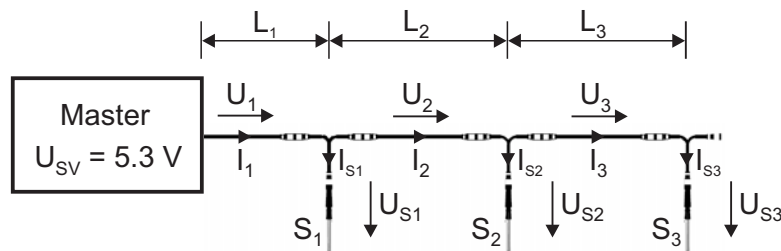

$L_x$	Length of line segment x (x = 1, 2, 3)
$U_{SV}$	Supply voltage at the point of feed-in
$U_x$	Voltage drop at line segment x
$I_x$	Current through line segment x
$S_x$	Sensor x
$I_{Sx}$	Current consumption of sensor x
$U_{Sx}$	Supply voltage at sensor x

#### Step 1: Calculate the current in the individual line segments

For the calculation of the current flowing through a line segment, the partial currents of all sensors, which are supplied via this segment, are added. For the bus structure shown above this means:

$$I_1 = I_{S1} + I_{S2} + I_{S3}$$

$$I_2 = I_{S2} + I_{S3}$$

$$I_3 = I_{S3}$$

The current consumption of a sensor is shown in the following table; it applies for Modbus operation without bus termination and a sampling time of 1 second.

Sensor	Average value of current consumption	Peak value of current consumption
digiLine pH/ORP/T	approx. 17 mA	approx. 20 mA
ecoLine O-DO	approx. 4 mA	approx. 50 mA
ecoLine NTU	approx. 2 mA	approx. 60 mA

In the case of bus termination at both ends (120 ohm), the current consumption increases during communication by up to 55 mA.

When operating with digiLine protocol, collisions occur on the bus during bus scan; this can also lead to increased current consumption. However, this is usually not critical, since there is

## 2 Connection

no measured value processing during the scan and therefore the supply voltage of the sensor may be lower.

For sensors of type digiLine pH/ORP/T, the calculation must be performed with the peak values:

$$I_1 = I_{S1} + I_{S2} + I_{S3} = 20 \text{ mA} + 20 \text{ mA} + 20 \text{ mA} = 60 \text{ mA}$$

$$I_2 = I_{S2} + I_{S3} = 20 \text{ mA} + 20 \text{ mA} = 40 \text{ mA}$$

$$I_3 = I_{S3} = 20 \text{ mA}$$

For sensors of type ecoLine O-DO/NTU, the highest peak value is used once and the remaining sensors are considered with their average values. Example for 1 x O-DO and 2 x NTU:

$$I_1 = I_{S1} + I_{S2} + I_{S3} = 4 \text{ mA} + 2 \text{ mA} + 60 \text{ mA} = 66 \text{ mA}$$

$$I_2 = I_{S2} + I_{S3} = 2 \text{ mA} + 60 \text{ mA} = 62 \text{ mA}$$

$$I_3 = I_{S3} = 60 \text{ mA}$$

For further calculation it is assumed that the following sensors are used in the bus structure shown above:

Sensor 1: digiLine pH (use peak value)

Sensor 2: ecoLine O-DO (use average value)

Sensor 3: ecoLine NTU (use peak value)

Thus, the following currents result:

$$I_1 = I_{S1} + I_{S2} + I_{S3} = 20 \text{ mA} + 4 \text{ mA} + 60 \text{ mA} = 84 \text{ mA} = \mathbf{0.084 \text{ A}}$$

$$I_2 = I_{S2} + I_{S3} = 4 \text{ mA} + 60 \text{ mA} = 64 \text{ mA} = \mathbf{0.064 \text{ A}}$$

$$I_3 = I_{S3} = 60 \text{ mA} = \mathbf{0.06 \text{ A}}$$

### Step 2: Calculate the voltage drop on the individual line segments

The cable lengths of the line segments are **20 m** each.

The voltage drop on a line segment is calculated in accordance with the following formula:

$$U_x = \rho \times 2 \times L_x \times I_x / A; \text{ with } \rho = 1/56 \text{ } \Omega\text{mm}^2/\text{m} \text{ and } A = 0.34 \text{ mm}^2$$

In the above example this means:

$$U_1 = \rho \times 2 \times L_1 \times I_1 / A = 1/56 \text{ } \Omega\text{mm}^2/\text{m} \times 2 \times \mathbf{20 \text{ m}} \times \mathbf{0.084 \text{ A}} / 0.34 \text{ mm}^2 = 0.177 \text{ V}$$

Shown in simplified form:

$$U_1 = 1/56 \text{ } \Omega \times 2 \times \mathbf{20} \times \mathbf{0.084 \text{ A}} / 0.34 = \mathbf{0.177 \text{ V}}$$

$$U_2 = 1/56 \text{ } \Omega \times 2 \times \mathbf{20} \times \mathbf{0.064 \text{ A}} / 0.34 = \mathbf{0.135 \text{ V}}$$

$$U_3 = 1/56 \text{ } \Omega \times 2 \times \mathbf{20} \times \mathbf{0.06 \text{ A}} / 0.34 = \mathbf{0.126 \text{ V}}$$

### Step 3: Calculate the voltage at the respective sensor

The value of the supply voltage at the respective sensor is given by the supply voltage at the point of feed-in minus the sum of all the voltages which drop on the line segments that are located between the point of feed-in and the sensor.

In the above example this means:

$$U_{S1} = U_{SV} - U_1 = 5.3 \text{ V} - 0.177 \text{ V} = 5.123 \text{ V} \approx \mathbf{5.1 \text{ V}}$$

$$U_{S2} = U_{SV} - U_1 - U_2 = 5.3 \text{ V} - 0.177 \text{ V} - 0.135 \text{ V} = 4.988 \text{ V} \approx \mathbf{5.0 \text{ V}}$$

$$U_{S3} = U_{SV} - U_1 - U_2 - U_3 = 5.3 \text{ V} - 0.177 \text{ V} - 0.135 \text{ V} - 0.126 \text{ V} = 4.862 \text{ V} \approx \mathbf{4.9 \text{ V}}$$

The required minimum voltage of the sensors is shown in the following table.

Sensor	Minimum voltage
digiLine pH/ORP/T	4.2 V
ecoLine O-DO	5 V
ecoLine NTU	5 V

## 2 Connection

---

The voltage at sensor 1 (digiLine pH) is well above the minimum value (4.2 V). The voltage at sensor 2 (ecoLine O-DO) roughly corresponds to the minimum value (5 V). For sensor 3 (ecoLine NTU), the voltage is not enough.



**NOTE!**

For the operation of ecoLine sensors, it is generally recommended to use digiLine hubs and to generate the DC 5.3 V supply voltage within the hub (variant 2 or 3).



**NOTE!**

The voltage drop calculation shown here no longer applies if sensor types tecLine (types 20263x), digiLine Ci/CR (types 20276x), or digiLine O-DO S10 (type 202614) are used additionally. These sensors do not represent a resistive load because they contain a switching converter (increasing current consumption with decreasing supply voltage). An iterative approach over power consumption is required for calculation (not part of this document).

## 2 Connection

---

### 3.1 General information

The sensors are connected to the central processing unit via the serial interface (RS485, Modbus RTU) using the Modbus master function and incorporated into the measuring, control, and automation system via the integrated PLC. A specific functional module is available for the PLC CODESYS software for the interface and for each sensor type, based on the IoDrvModbus library (part of the boot project with version 3.5.3.0; an update is not allowed).

The interface is configured exclusively using CODESYS. Configuration parameters already established in the setup program or on the multifunction panel are overwritten internally; the changes are not visible in the setup program. The interface parameters and Modbus addresses (slave addresses) must match the sensor settings.

The sensors are configured and calibrated with the DSM sensor management tool. "8-1-no parity" must be selected as the data format (baud rate: 9600, 19200, or 38400).

The functional modules for the serial interface (including Modbus frames) and the sensors are made available as export files, which have to be imported into the PLC project. To do this, the PLC project first has to be loaded from the setup program and into CODESYS. After importing the functional modules and configuring them in CODESYS, the PLC project is transferred back to the setup program and finally transmitted to the system as a setup file.

Certain sensors measure the current value in cycles; for some sensors, every measuring cycle has to be started by the PLC. The special features of the various sensors are taken into account in the specific functional modules, along with any necessary format conversions or changes to the measuring range.

The physical measurand measured by the sensor along with other analog and digital signals from the sensor (counter values, alarm and status signals) are transmitted via Modbus. Corresponding configurations in CODESYS allow these signals to be made available for further use in the measuring, control, and automation system.

### 3.2 Delivery of export files

The export files are supplied on the mini DVD along with the setup program (plus other software and the technical documentation). They can also be downloaded from the manufacturer's website. Specific export files are required for each version of CODESYS.

The individual files are combined in a ZIP file; the file name is made up of various information, including the issue date and the CODESYS version.

Sample ZIP file: *JUMO digiLine\_2016-03-14\_CV3.5.3.9.zip*

CV.3.5.3.9 refers to the CODESYS version and means the following:

CODESYS version 3.5 SP3 Patch 9

A separate export file is provided for each sensor type; the file name is made up of the sensor type and a version number.

Sample export file for a temperature sensor: *Temp\_202705\_V373.01.02.export*

An export file is also provided for the interface function (Modbus\_COM\_...).

The ZIP file also includes a directory containing technical documentation.

# 3 Configuration

## 3.3 Importing export files

The following description shows how to import and use the interface and sensor export files in CODESYS.

### 3.3.1 Importing the interface into the device tree

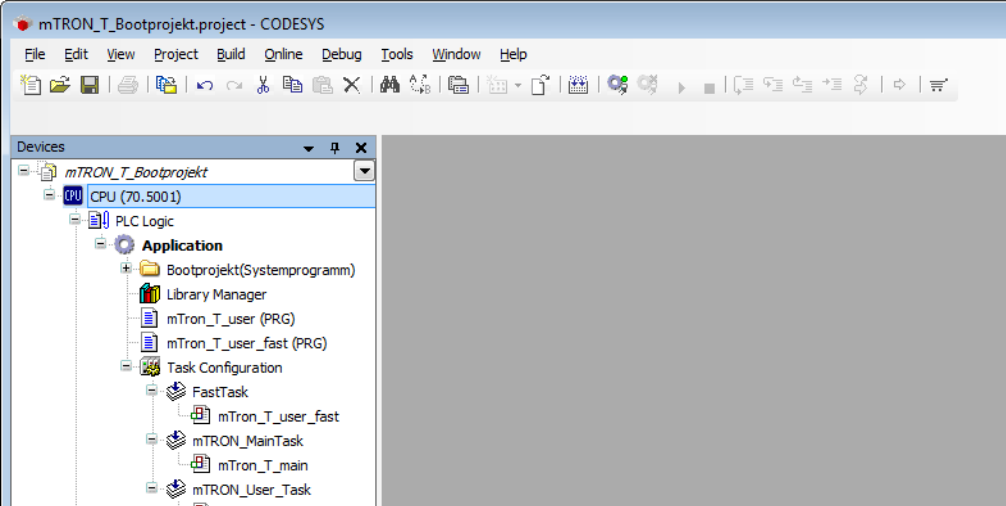
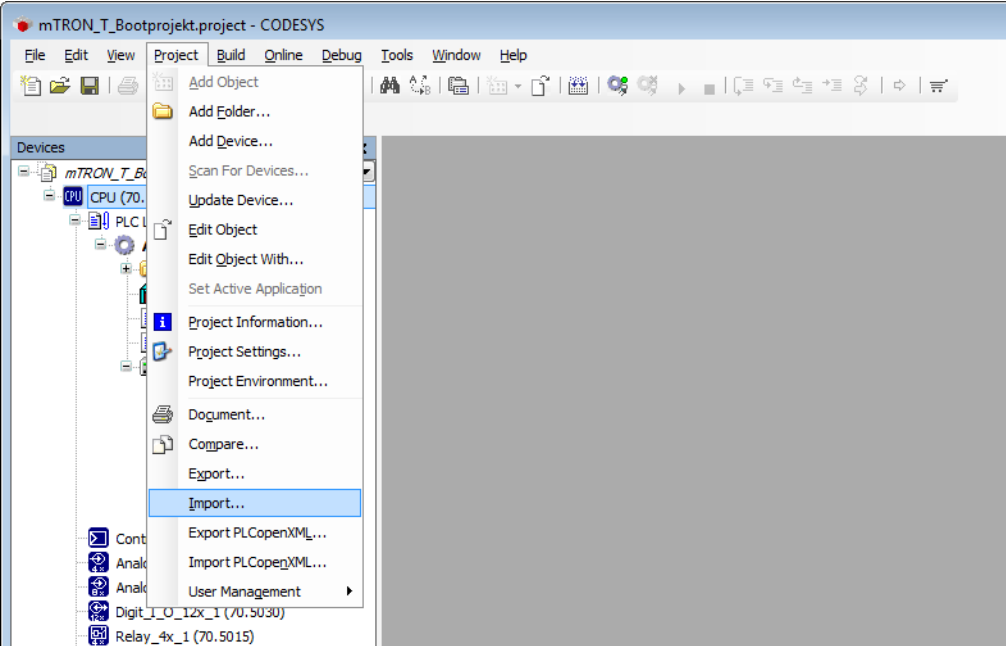
Step	Activity
1	<p>Click on CPU in the device tree</p>  <p>The screenshot shows the CODESYS interface for a project named 'mTRON_T_Bootprojekt.project'. The 'Devices' tree on the left is expanded to show 'CPU (70.5001)' selected. Below it, the 'Application' tree is visible, containing folders like 'Bootprojekt(Systemprogramm)', 'Library Manager', and several program files (PRG) and task configurations.</p>
2	<p>Project &gt; Import</p>  <p>The screenshot shows the same CODESYS interface, but with the 'Project' menu open. The 'Import...' option is highlighted in blue. Other options in the menu include 'Add Object', 'Add Folder...', 'Add Device...', 'Scan For Devices...', 'Update Device...', 'Edit Object', 'Edit Object With...', 'Set Active Application', 'Project Information...', 'Project Settings...', 'Project Environment...', 'Document...', 'Compare...', 'Export...', 'Export PLCopenXML...', 'Import PLCopenXML...', and 'User Management'.</p>

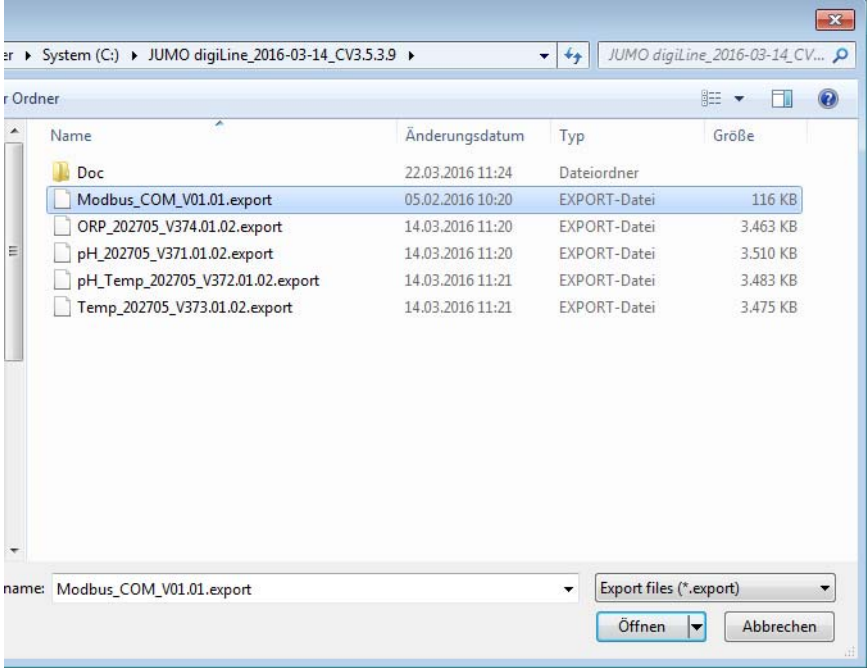
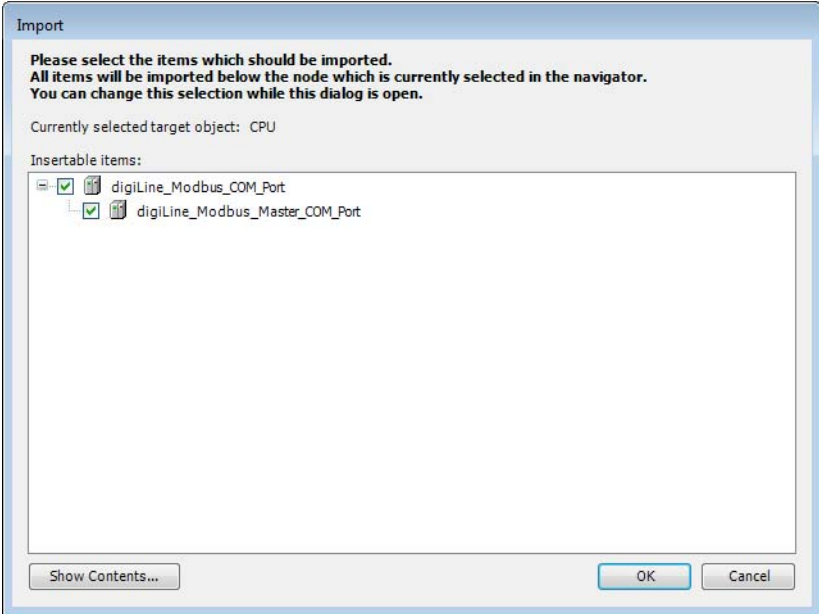
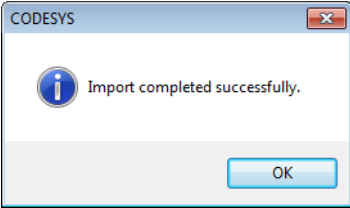
Step	Activity																												
3	<p>Select the interface export file from the file directory and adopt it by clicking "Open"</p>  <p>The screenshot shows a Windows File Explorer window with the address bar set to 'System (C:) &gt; JUMO digiLine_2016-03-14_CV3.5.3.9 &gt; JUMO digiLine_2016-03-14_CV...'. The main pane displays a list of files and folders:</p> <table border="1"><thead><tr><th>Name</th><th>Änderungsdatum</th><th>Typ</th><th>Größe</th></tr></thead><tbody><tr><td>Doc</td><td>22.03.2016 11:24</td><td>Dateiordner</td><td></td></tr><tr><td>Modbus_COM_V01.01.export</td><td>05.02.2016 10:20</td><td>EXPORT-Datei</td><td>116 KB</td></tr><tr><td>ORP_202705_V374.01.02.export</td><td>14.03.2016 11:20</td><td>EXPORT-Datei</td><td>3.463 KB</td></tr><tr><td>pH_202705_V371.01.02.export</td><td>14.03.2016 11:20</td><td>EXPORT-Datei</td><td>3.510 KB</td></tr><tr><td>pH_Temp_202705_V372.01.02.export</td><td>14.03.2016 11:21</td><td>EXPORT-Datei</td><td>3.483 KB</td></tr><tr><td>Temp_202705_V373.01.02.export</td><td>14.03.2016 11:21</td><td>EXPORT-Datei</td><td>3.475 KB</td></tr></tbody></table> <p>The 'name' field at the bottom contains 'Modbus_COM_V01.01.export' and the file type is set to 'Export files (*.export)'. The 'Öffnen' (Open) button is highlighted.</p>	Name	Änderungsdatum	Typ	Größe	Doc	22.03.2016 11:24	Dateiordner		Modbus_COM_V01.01.export	05.02.2016 10:20	EXPORT-Datei	116 KB	ORP_202705_V374.01.02.export	14.03.2016 11:20	EXPORT-Datei	3.463 KB	pH_202705_V371.01.02.export	14.03.2016 11:20	EXPORT-Datei	3.510 KB	pH_Temp_202705_V372.01.02.export	14.03.2016 11:21	EXPORT-Datei	3.483 KB	Temp_202705_V373.01.02.export	14.03.2016 11:21	EXPORT-Datei	3.475 KB
Name	Änderungsdatum	Typ	Größe																										
Doc	22.03.2016 11:24	Dateiordner																											
Modbus_COM_V01.01.export	05.02.2016 10:20	EXPORT-Datei	116 KB																										
ORP_202705_V374.01.02.export	14.03.2016 11:20	EXPORT-Datei	3.463 KB																										
pH_202705_V371.01.02.export	14.03.2016 11:20	EXPORT-Datei	3.510 KB																										
pH_Temp_202705_V372.01.02.export	14.03.2016 11:21	EXPORT-Datei	3.483 KB																										
Temp_202705_V373.01.02.export	14.03.2016 11:21	EXPORT-Datei	3.475 KB																										
4	<p>Select both objects and import by pressing "OK"</p>  <p>The screenshot shows an 'Import' dialog box with the following text:</p> <p>Please select the items which should be imported. All items will be imported below the node which is currently selected in the navigator. You can change this selection while this dialog is open.</p> <p>Currently selected target object: CPU</p> <p>Insertable items:</p> <ul style="list-style-type: none"><li><input checked="" type="checkbox"/> digiLine_Modbus_COM_Port</li><li><input checked="" type="checkbox"/> digiLine_Modbus_Master_COM_Port</li></ul> <p>The 'OK' button is highlighted.</p>																												
5	<p>Confirm the message by pressing "OK"</p>  <p>The screenshot shows a 'CODESYS' information dialog box with the following text:</p> <p>Import completed successfully.</p> <p>The 'OK' button is highlighted.</p>																												

### 3 Configuration

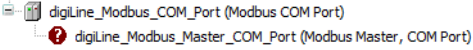
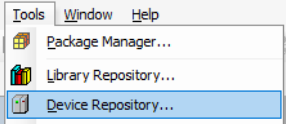
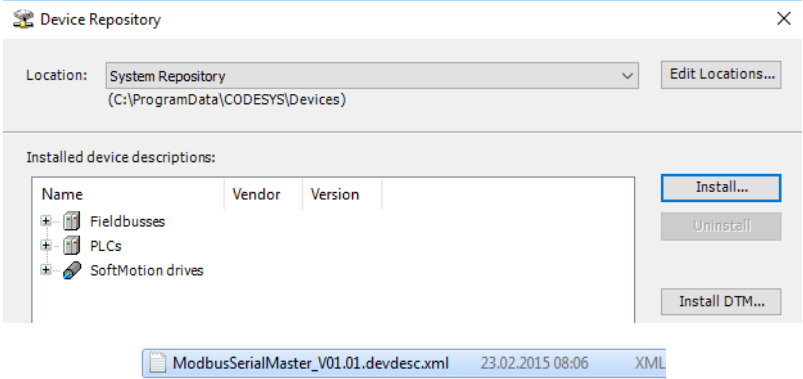
Step	Activity
6	<p>If necessary, install the missing device description</p>  <p>If – after the import – there is a question mark in front of line "digiLine_Modbus_Master...", the device description still has to be installed (steps 7 and 8).</p>
7	<p>Open the device repository</p> 
8	<p>Click on "Install..." button and select the "ModbusSerialMasterV01.01.devdesc.xml" file from the file directory</p> 

## 3.3.2 Importing the sensor into the device tree

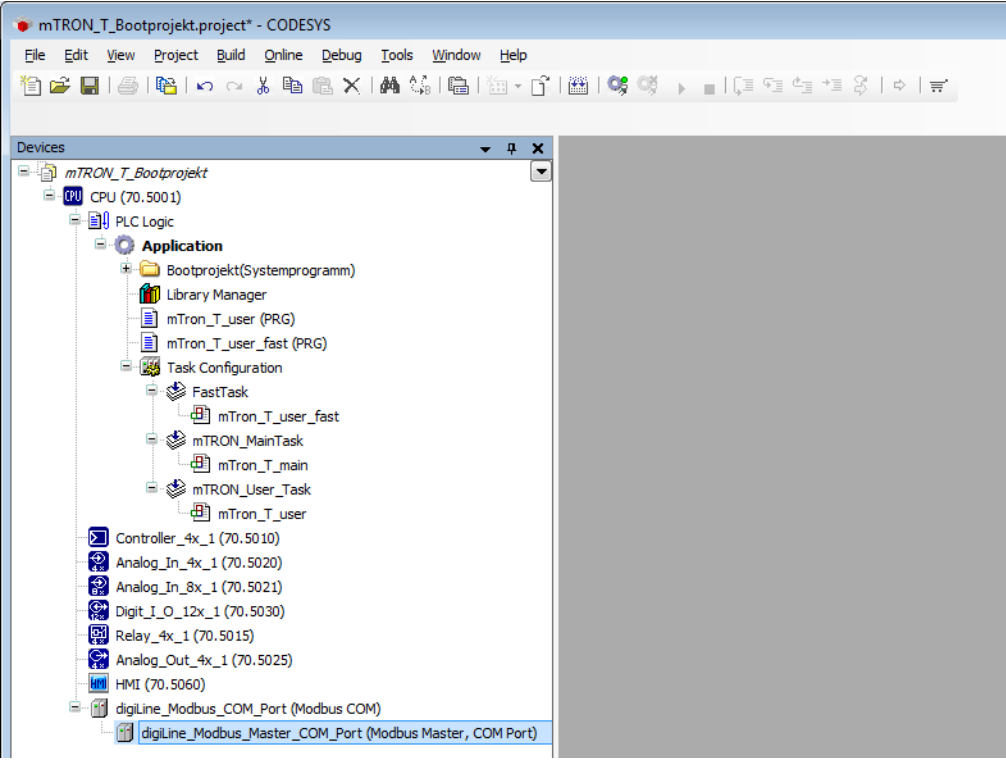
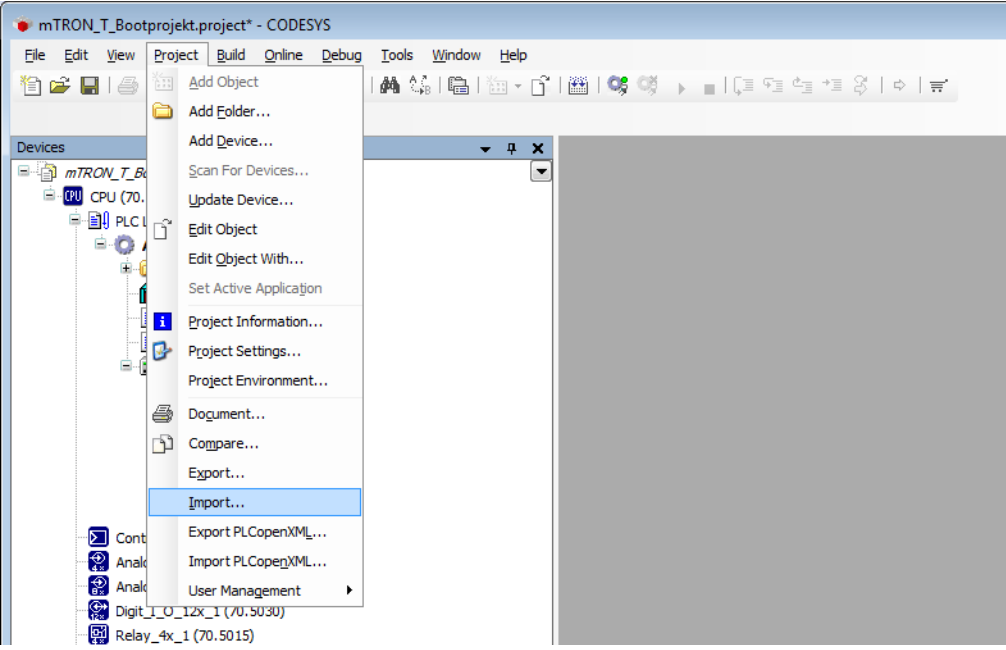
Step	Activity
1	<p>Click on Modbus master in the device tree</p> 
2	<p>Project &gt; Import</p> 

### 3 Configuration

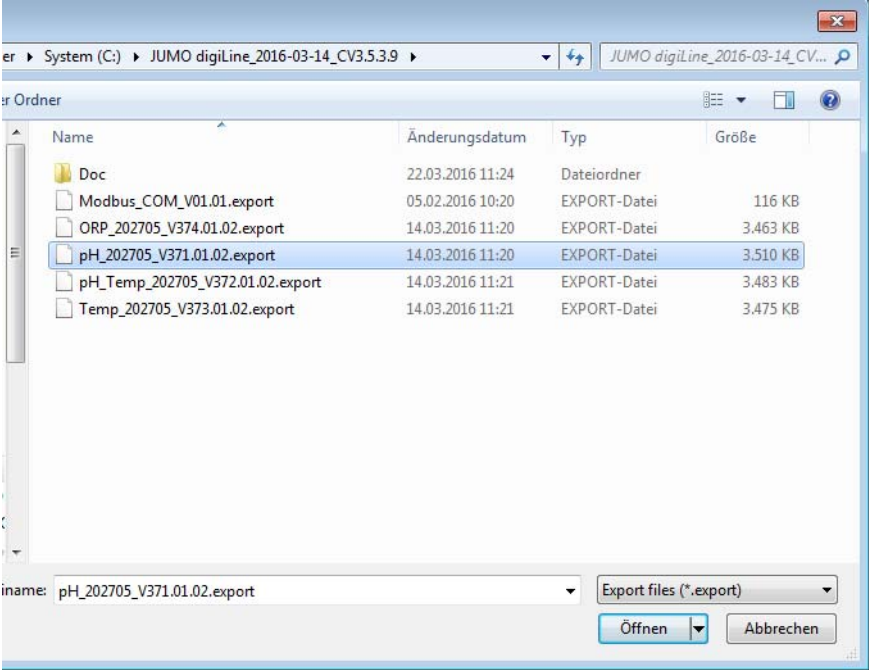
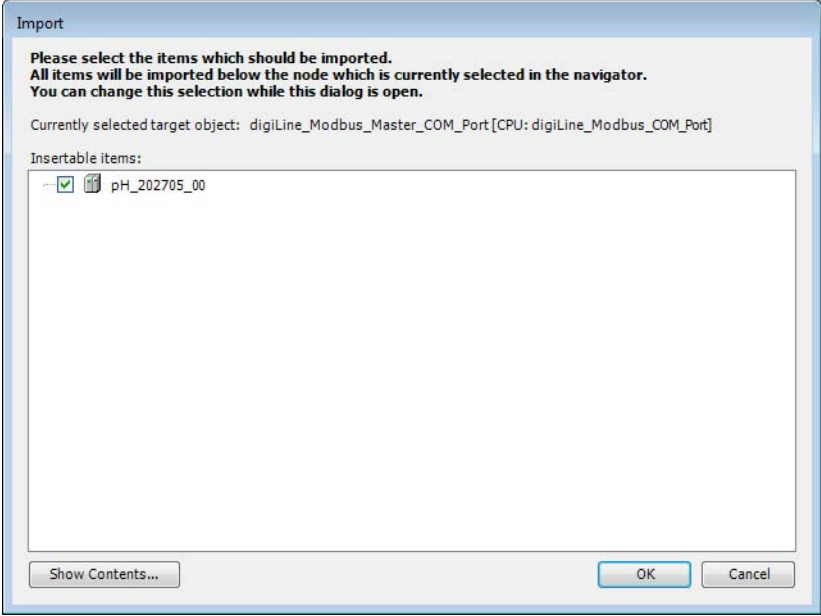
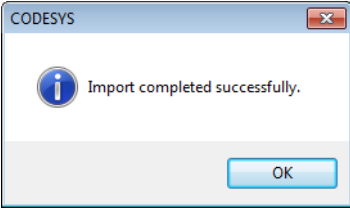
Step	Activity																												
3	<p>Select the sensor export file from the file directory and adopt it by clicking "Open"</p>  <p>The screenshot shows a Windows File Explorer window with the address bar set to 'System (C:) &gt; JUMO digiLine_2016-03-14_CV3.5.3.9 &gt; JUMO digiLine_2016-03-14_CV...'. The main pane displays a table of files and folders:</p> <table border="1"><thead><tr><th>Name</th><th>Änderungsdatum</th><th>Typ</th><th>Größe</th></tr></thead><tbody><tr><td>Doc</td><td>22.03.2016 11:24</td><td>Dateiordner</td><td></td></tr><tr><td>Modbus_COM_V01.01.export</td><td>05.02.2016 10:20</td><td>EXPORT-Datei</td><td>116 KB</td></tr><tr><td>ORP_202705_V374.01.02.export</td><td>14.03.2016 11:20</td><td>EXPORT-Datei</td><td>3.463 KB</td></tr><tr><td><b>pH_202705_V371.01.02.export</b></td><td>14.03.2016 11:20</td><td>EXPORT-Datei</td><td>3.510 KB</td></tr><tr><td>pH_Temp_202705_V372.01.02.export</td><td>14.03.2016 11:21</td><td>EXPORT-Datei</td><td>3.483 KB</td></tr><tr><td>Temp_202705_V373.01.02.export</td><td>14.03.2016 11:21</td><td>EXPORT-Datei</td><td>3.475 KB</td></tr></tbody></table> <p>The 'Name' column is highlighted, and the file 'pH_202705_V371.01.02.export' is selected. The 'Dateiname' field at the bottom contains 'pH_202705_V371.01.02.export' and the file type is set to 'Export files (*.export)'. The 'Öffnen' (Open) button is visible.</p>	Name	Änderungsdatum	Typ	Größe	Doc	22.03.2016 11:24	Dateiordner		Modbus_COM_V01.01.export	05.02.2016 10:20	EXPORT-Datei	116 KB	ORP_202705_V374.01.02.export	14.03.2016 11:20	EXPORT-Datei	3.463 KB	<b>pH_202705_V371.01.02.export</b>	14.03.2016 11:20	EXPORT-Datei	3.510 KB	pH_Temp_202705_V372.01.02.export	14.03.2016 11:21	EXPORT-Datei	3.483 KB	Temp_202705_V373.01.02.export	14.03.2016 11:21	EXPORT-Datei	3.475 KB
Name	Änderungsdatum	Typ	Größe																										
Doc	22.03.2016 11:24	Dateiordner																											
Modbus_COM_V01.01.export	05.02.2016 10:20	EXPORT-Datei	116 KB																										
ORP_202705_V374.01.02.export	14.03.2016 11:20	EXPORT-Datei	3.463 KB																										
<b>pH_202705_V371.01.02.export</b>	14.03.2016 11:20	EXPORT-Datei	3.510 KB																										
pH_Temp_202705_V372.01.02.export	14.03.2016 11:21	EXPORT-Datei	3.483 KB																										
Temp_202705_V373.01.02.export	14.03.2016 11:21	EXPORT-Datei	3.475 KB																										
4	<p>Select the object and import by pressing "OK"</p>  <p>The screenshot shows an 'Import' dialog box with the following text:</p> <p><b>Import</b></p> <p>Please select the items which should be imported. All items will be imported below the node which is currently selected in the navigator. You can change this selection while this dialog is open.</p> <p>Currently selected target object: digiLine_Modbus_Master_COM_Port [CPU: digiLine_Modbus_COM_Port]</p> <p>Insertable items:</p> <ul style="list-style-type: none"><li><input checked="" type="checkbox"/> pH_202705_00</li></ul> <p>Buttons: Show Contents..., OK, Cancel</p>																												
5	<p>Confirm the message by pressing "OK"</p>  <p>The screenshot shows a 'CODESYS' information dialog box with the following text:</p> <p><b>CODESYS</b></p> <p>Import completed successfully.</p> <p>Button: OK</p>																												

## 3.3.3 Importing the functional module into the application

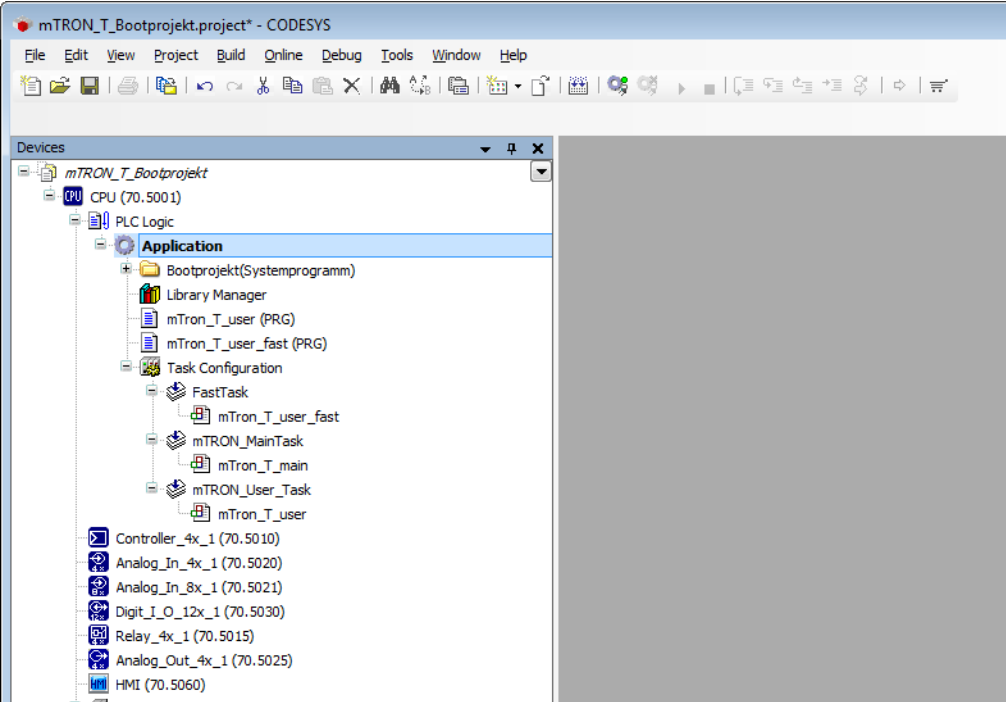
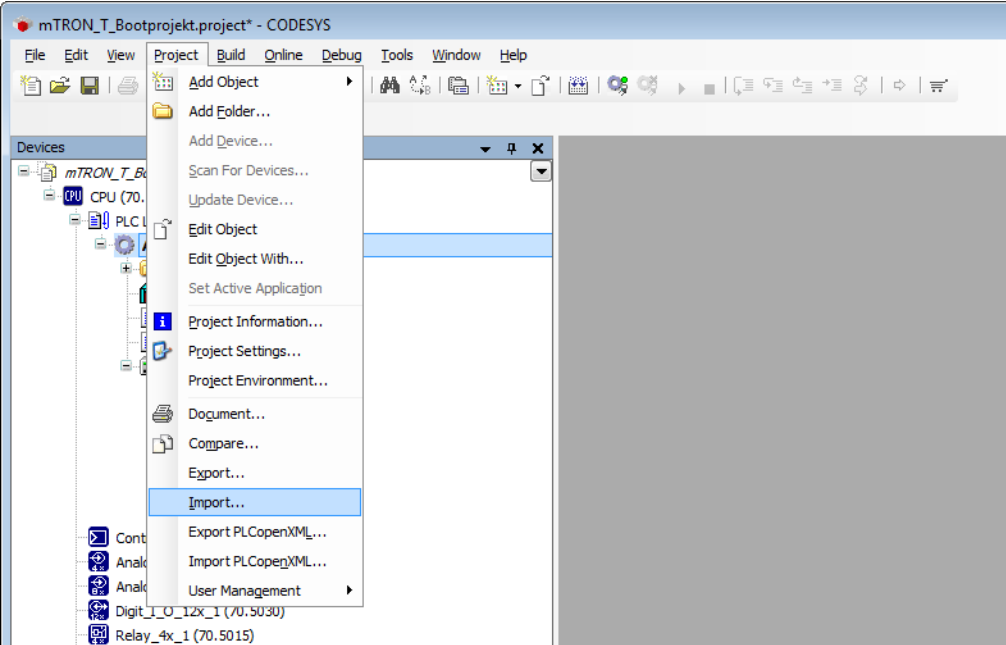
Step	Activity
1	<p>Click on Application in the device tree</p>  <p>The screenshot shows the CODESYS interface for a project named 'mTRON_T_Bootprojekt.project*'. The 'Devices' tree on the left is expanded to show the 'Application' folder under the 'PLC Logic' folder. The 'Application' folder is highlighted in blue. Below it, several sub-folders and objects are visible, including 'Bootprojekt(Systemprogramm)', 'Library Manager', 'mTron_T_user (PRG)', 'mTron_T_user_fast (PRG)', 'Task Configuration', 'FastTask', 'mTron_T_user_fast', 'mTRON_MainTask', 'mTron_T_main', 'mTRON_User_Task', and 'mTron_T_user'. Other hardware components like 'Controller_4x_1 (70.5010)', 'Analog_In_4x_1 (70.5020)', 'Analog_In_8x_1 (70.5021)', 'Digit_I_O_12x_1 (70.5030)', 'Relay_4x_1 (70.5015)', and 'Analog_Out_4x_1 (70.5025)' are also listed in the tree.</p>
2	<p>Project &gt; Import</p>  <p>The screenshot shows the same CODESYS interface, but with the 'Project' menu open. The 'Import...' option is highlighted in blue. The menu items include: 'Add Object', 'Add Folder...', 'Add Device...', 'Scan For Devices...', 'Update Device...', 'Edit Object', 'Edit Object With...', 'Set Active Application', 'Project Information...', 'Project Settings...', 'Project Environment...', 'Document...', 'Compare...', 'Export...', 'Import...', 'Export PLCopenXML...', 'Import PLCopenXML...', and 'User Management'.</p>

### 3 Configuration

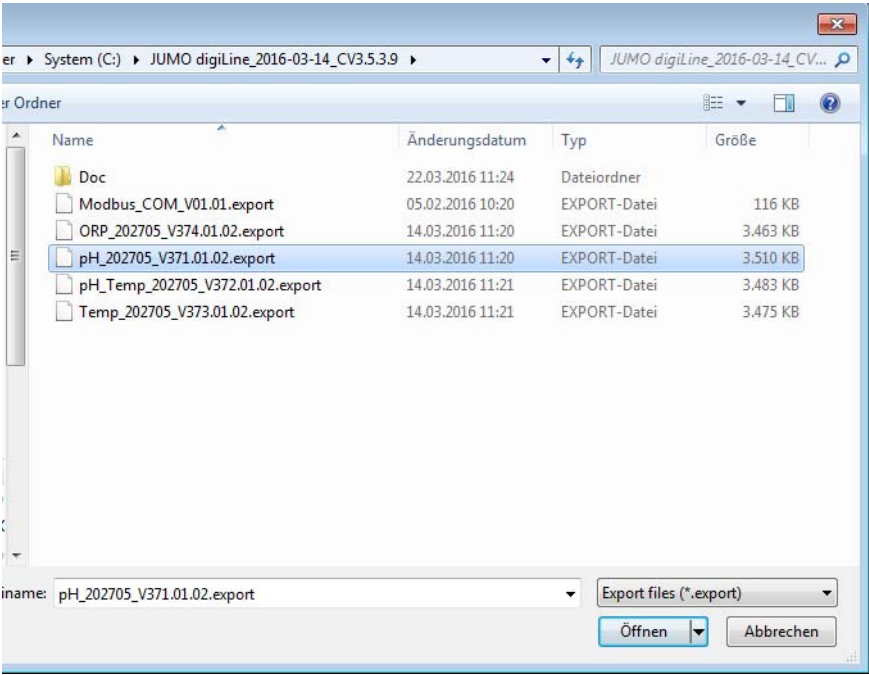
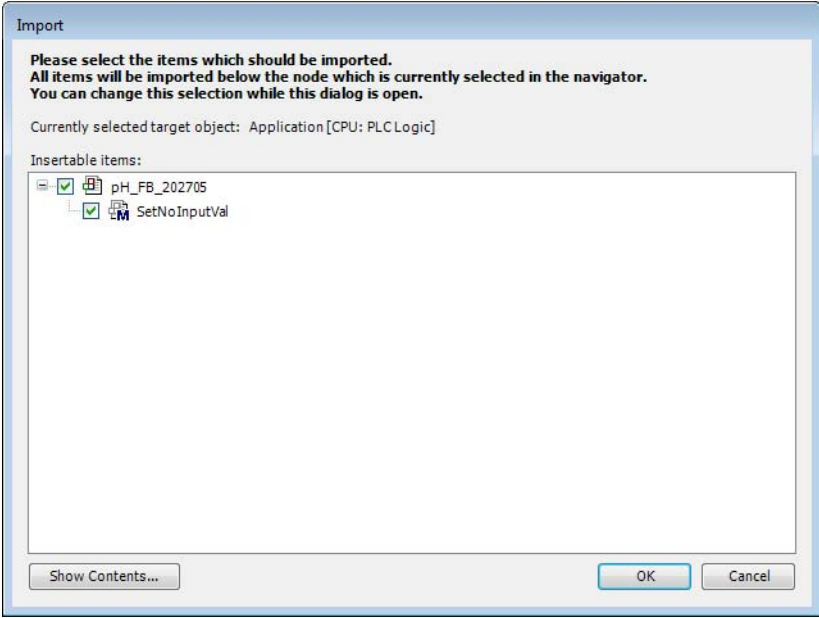
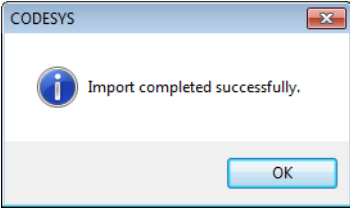
Step	Activity																												
3	<p>Select the sensor export file from the file directory and adopt it by clicking "Open"</p>  <p>The screenshot shows a Windows File Explorer window with the address bar set to 'System (C:) &gt; JUMO digiLine_2016-03-14_CV3.5.3.9 &gt; JUMO digiLine_2016-03-14_CV...'. The main pane displays a table of files:</p> <table border="1"><thead><tr><th>Name</th><th>Änderungsdatum</th><th>Typ</th><th>Größe</th></tr></thead><tbody><tr><td>Doc</td><td>22.03.2016 11:24</td><td>Dateiordner</td><td></td></tr><tr><td>Modbus_COM_V01.01.export</td><td>05.02.2016 10:20</td><td>EXPORT-Datei</td><td>116 KB</td></tr><tr><td>ORP_202705_V374.01.02.export</td><td>14.03.2016 11:20</td><td>EXPORT-Datei</td><td>3.463 KB</td></tr><tr><td><b>pH_202705_V371.01.02.export</b></td><td>14.03.2016 11:20</td><td>EXPORT-Datei</td><td>3.510 KB</td></tr><tr><td>pH_Temp_202705_V372.01.02.export</td><td>14.03.2016 11:21</td><td>EXPORT-Datei</td><td>3.483 KB</td></tr><tr><td>Temp_202705_V373.01.02.export</td><td>14.03.2016 11:21</td><td>EXPORT-Datei</td><td>3.475 KB</td></tr></tbody></table> <p>The 'Name' column is selected, and the file 'pH_202705_V371.01.02.export' is highlighted. The 'Dateiname:' field at the bottom contains 'pH_202705_V371.01.02.export' and the file type is set to 'Export files (*.export)'. The 'Öffnen' (Open) button is visible.</p>	Name	Änderungsdatum	Typ	Größe	Doc	22.03.2016 11:24	Dateiordner		Modbus_COM_V01.01.export	05.02.2016 10:20	EXPORT-Datei	116 KB	ORP_202705_V374.01.02.export	14.03.2016 11:20	EXPORT-Datei	3.463 KB	<b>pH_202705_V371.01.02.export</b>	14.03.2016 11:20	EXPORT-Datei	3.510 KB	pH_Temp_202705_V372.01.02.export	14.03.2016 11:21	EXPORT-Datei	3.483 KB	Temp_202705_V373.01.02.export	14.03.2016 11:21	EXPORT-Datei	3.475 KB
Name	Änderungsdatum	Typ	Größe																										
Doc	22.03.2016 11:24	Dateiordner																											
Modbus_COM_V01.01.export	05.02.2016 10:20	EXPORT-Datei	116 KB																										
ORP_202705_V374.01.02.export	14.03.2016 11:20	EXPORT-Datei	3.463 KB																										
<b>pH_202705_V371.01.02.export</b>	14.03.2016 11:20	EXPORT-Datei	3.510 KB																										
pH_Temp_202705_V372.01.02.export	14.03.2016 11:21	EXPORT-Datei	3.483 KB																										
Temp_202705_V373.01.02.export	14.03.2016 11:21	EXPORT-Datei	3.475 KB																										
4	<p>Select all objects and import by pressing "OK"</p>  <p>The screenshot shows an 'Import' dialog box with the following text:</p> <p><b>Import</b></p> <p>Please select the items which should be imported. All items will be imported below the node which is currently selected in the navigator. You can change this selection while this dialog is open.</p> <p>Currently selected target object: Application [CPU: PLC Logic]</p> <p>Insertable items:</p> <ul style="list-style-type: none"><li><input checked="" type="checkbox"/> pH_FB_202705</li><li><input checked="" type="checkbox"/> SetNoInputVal</li></ul> <p>Buttons: Show Contents..., OK, Cancel</p>																												
5	<p>Confirm the message by pressing "OK"</p>  <p>The screenshot shows a 'CODESYS' dialog box with the following text:</p> <p><b>CODESYS</b></p> <p>Import completed successfully.</p> <p>Button: OK</p>																												

## 3.3.4 Configuring the interface

The interface parameters and slave address must match the settings made for the sensors in question using the DSM sensor management tool.

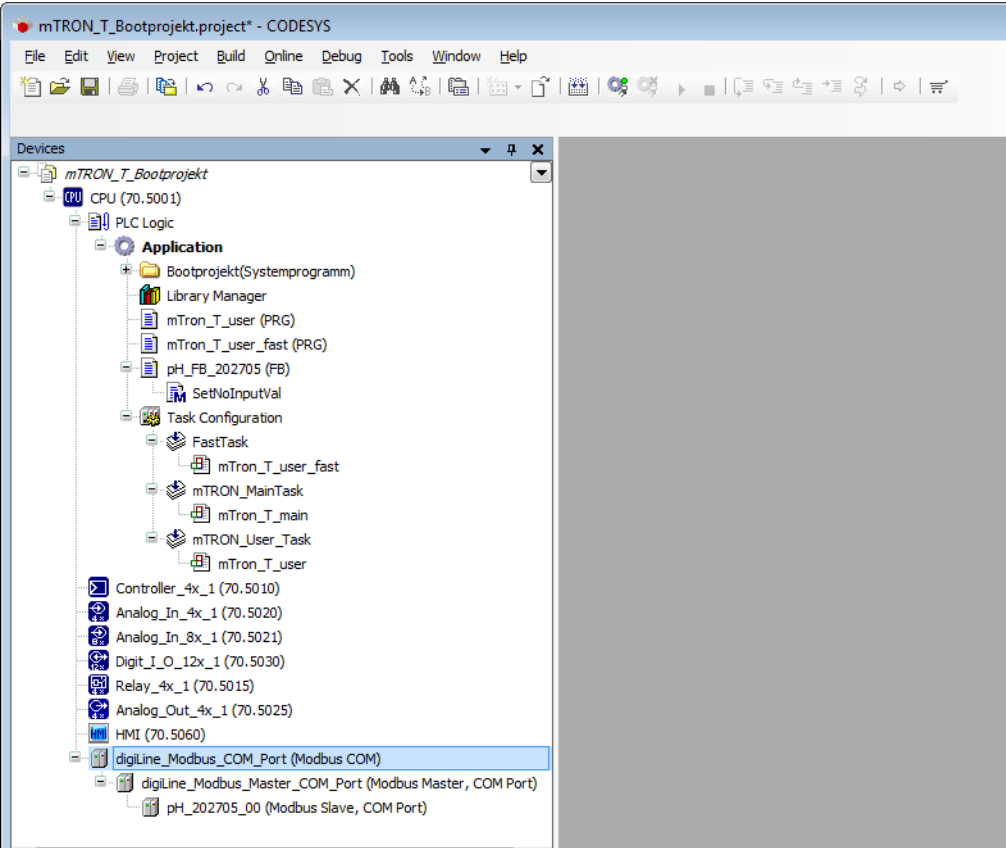
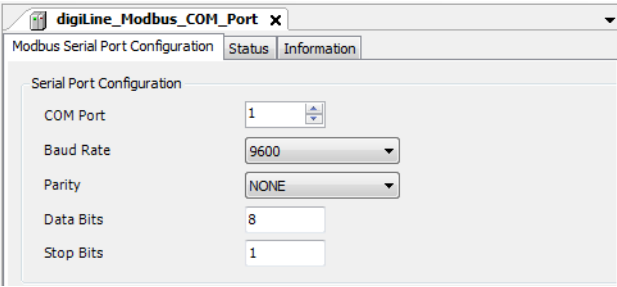
Step	Activity
1	<p>Double click Modbus_COM_Port to open it</p> 
2	<p>Adjust the interface parameters</p>  <p>The interface parameters have to match the sensor configurations (use the DSM sensor management tool if necessary).</p> <p>Important information:  "8-1-no parity" must be selected as the data format in the sensor configurations. The following baud rates are supported: 9600, 19200, and 38400.</p>

## 3 Configuration

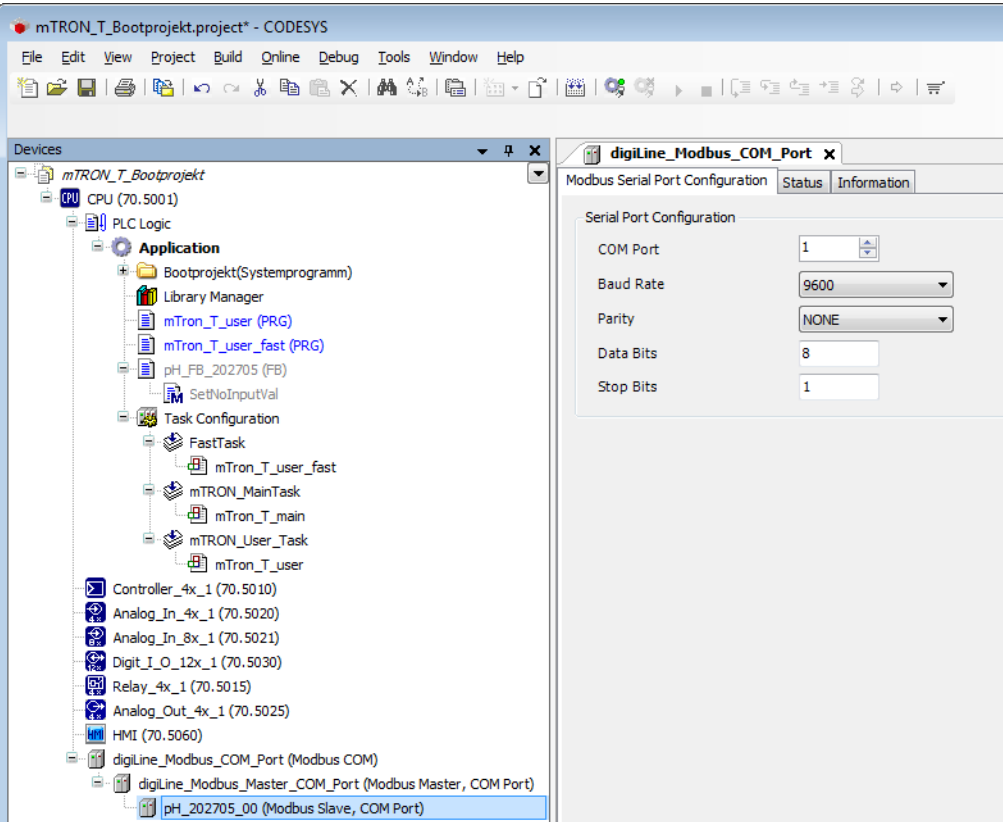
Step	Activity
3	<p data-bbox="395 282 986 309">Double click the sensor (Modbus slave) to open it</p>  <p data-bbox="395 1151 1402 1272">We recommend changing the name of the sensor (here: pH_202705_00) (Context menu &gt; Properties) in order to distinguish between several sensors of the same type. The name suffix (here: 00) should be used to number the sensors (e.g.: use 01, 02, ...; or slave address).</p>

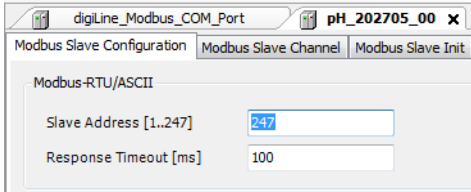
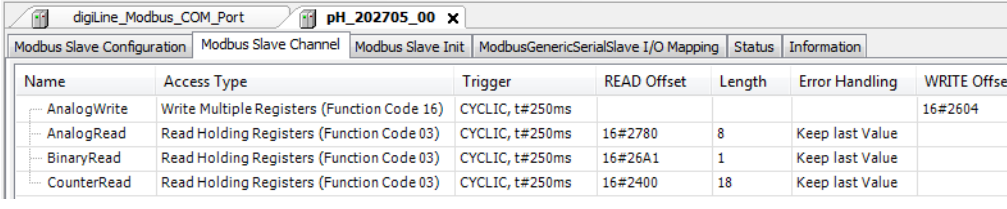
Step	Activity																																			
4	<p>Adjust the slave address</p>  <p>The slave address must match the sensor configuration (use the sensor management tool if necessary). The "Response Timeout [ms]" parameter does not mean anything in case of the pH/ORP/Temp sensors but still must not be changed from the pre-selected value (here: 100). In case of the NTU and O-DO sensors, a value of 500 has to be set.</p> <p>"Modbus Slave Channel" tab (for information only): the sensor's analog values, binary values, and counter figures are each transferred in a Modbus frame (...Read); the same applies to the input values for the sensor (...Write).</p>  <table border="1"> <thead> <tr> <th>Name</th> <th>Access Type</th> <th>Trigger</th> <th>READ Offset</th> <th>Length</th> <th>Error Handling</th> <th>WRITE Offset</th> </tr> </thead> <tbody> <tr> <td>AnalogWrite</td> <td>Write Multiple Registers (Function Code 16)</td> <td>CYCLIC, t#250ms</td> <td></td> <td></td> <td></td> <td>16#2604</td> </tr> <tr> <td>AnalogRead</td> <td>Read Holding Registers (Function Code 03)</td> <td>CYCLIC, t#250ms</td> <td>16#2780</td> <td>8</td> <td>Keep last Value</td> <td></td> </tr> <tr> <td>BinaryRead</td> <td>Read Holding Registers (Function Code 03)</td> <td>CYCLIC, t#250ms</td> <td>16#26A1</td> <td>1</td> <td>Keep last Value</td> <td></td> </tr> <tr> <td>CounterRead</td> <td>Read Holding Registers (Function Code 03)</td> <td>CYCLIC, t#250ms</td> <td>16#2400</td> <td>18</td> <td>Keep last Value</td> <td></td> </tr> </tbody> </table>	Name	Access Type	Trigger	READ Offset	Length	Error Handling	WRITE Offset	AnalogWrite	Write Multiple Registers (Function Code 16)	CYCLIC, t#250ms				16#2604	AnalogRead	Read Holding Registers (Function Code 03)	CYCLIC, t#250ms	16#2780	8	Keep last Value		BinaryRead	Read Holding Registers (Function Code 03)	CYCLIC, t#250ms	16#26A1	1	Keep last Value		CounterRead	Read Holding Registers (Function Code 03)	CYCLIC, t#250ms	16#2400	18	Keep last Value	
Name	Access Type	Trigger	READ Offset	Length	Error Handling	WRITE Offset																														
AnalogWrite	Write Multiple Registers (Function Code 16)	CYCLIC, t#250ms				16#2604																														
AnalogRead	Read Holding Registers (Function Code 03)	CYCLIC, t#250ms	16#2780	8	Keep last Value																															
BinaryRead	Read Holding Registers (Function Code 03)	CYCLIC, t#250ms	16#26A1	1	Keep last Value																															
CounterRead	Read Holding Registers (Function Code 03)	CYCLIC, t#250ms	16#2400	18	Keep last Value																															

# 3 Configuration

## 3.3.5 Editing the names of variables

The names of all sensors' variables must be unique within the measuring, control, and automation system.

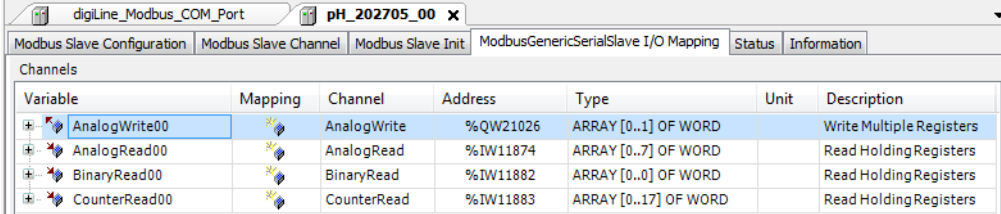
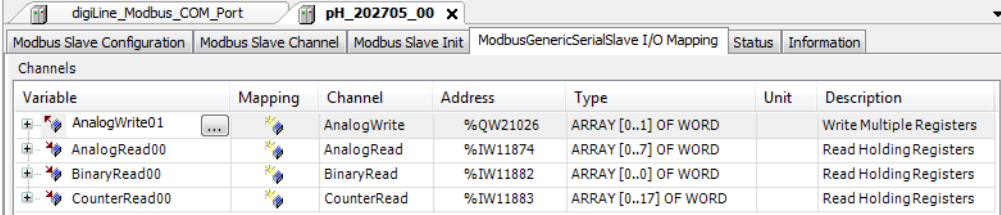
Step	Activity																																			
1	<p>Switch to the "...I/O Mapping" tab and double click on the name of the first variable to open and edit it</p>  <table border="1"> <thead> <tr> <th>Variable</th> <th>Mapping</th> <th>Channel</th> <th>Address</th> <th>Type</th> <th>Unit</th> <th>Description</th> </tr> </thead> <tbody> <tr> <td>AnalogWrite00</td> <td></td> <td>AnalogWrite</td> <td>%QW21026</td> <td>ARRAY [0..1] OF WORD</td> <td></td> <td>Write Multiple Registers</td> </tr> <tr> <td>AnalogRead00</td> <td></td> <td>AnalogRead</td> <td>%IW11874</td> <td>ARRAY [0..7] OF WORD</td> <td></td> <td>Read Holding Registers</td> </tr> <tr> <td>BinaryRead00</td> <td></td> <td>BinaryRead</td> <td>%IW11882</td> <td>ARRAY [0..0] OF WORD</td> <td></td> <td>Read Holding Registers</td> </tr> <tr> <td>CounterRead00</td> <td></td> <td>CounterRead</td> <td>%IW11883</td> <td>ARRAY [0..17] OF WORD</td> <td></td> <td>Read Holding Registers</td> </tr> </tbody> </table>	Variable	Mapping	Channel	Address	Type	Unit	Description	AnalogWrite00		AnalogWrite	%QW21026	ARRAY [0..1] OF WORD		Write Multiple Registers	AnalogRead00		AnalogRead	%IW11874	ARRAY [0..7] OF WORD		Read Holding Registers	BinaryRead00		BinaryRead	%IW11882	ARRAY [0..0] OF WORD		Read Holding Registers	CounterRead00		CounterRead	%IW11883	ARRAY [0..17] OF WORD		Read Holding Registers
Variable	Mapping	Channel	Address	Type	Unit	Description																														
AnalogWrite00		AnalogWrite	%QW21026	ARRAY [0..1] OF WORD		Write Multiple Registers																														
AnalogRead00		AnalogRead	%IW11874	ARRAY [0..7] OF WORD		Read Holding Registers																														
BinaryRead00		BinaryRead	%IW11882	ARRAY [0..0] OF WORD		Read Holding Registers																														
CounterRead00		CounterRead	%IW11883	ARRAY [0..17] OF WORD		Read Holding Registers																														
2	<p>Edit the names of variables (example)</p>  <table border="1"> <thead> <tr> <th>Variable</th> <th>Mapping</th> <th>Channel</th> <th>Address</th> <th>Type</th> <th>Unit</th> <th>Description</th> </tr> </thead> <tbody> <tr> <td>AnalogWrite01</td> <td></td> <td>AnalogWrite</td> <td>%QW21026</td> <td>ARRAY [0..1] OF WORD</td> <td></td> <td>Write Multiple Registers</td> </tr> <tr> <td>AnalogRead00</td> <td></td> <td>AnalogRead</td> <td>%IW11874</td> <td>ARRAY [0..7] OF WORD</td> <td></td> <td>Read Holding Registers</td> </tr> <tr> <td>BinaryRead00</td> <td></td> <td>BinaryRead</td> <td>%IW11882</td> <td>ARRAY [0..0] OF WORD</td> <td></td> <td>Read Holding Registers</td> </tr> <tr> <td>CounterRead00</td> <td></td> <td>CounterRead</td> <td>%IW11883</td> <td>ARRAY [0..17] OF WORD</td> <td></td> <td>Read Holding Registers</td> </tr> </tbody> </table> <p>We recommend adapting the name suffix (here: 00) to the sensor number (here: 01); see "Configuring the interface", step 3.</p>	Variable	Mapping	Channel	Address	Type	Unit	Description	AnalogWrite01		AnalogWrite	%QW21026	ARRAY [0..1] OF WORD		Write Multiple Registers	AnalogRead00		AnalogRead	%IW11874	ARRAY [0..7] OF WORD		Read Holding Registers	BinaryRead00		BinaryRead	%IW11882	ARRAY [0..0] OF WORD		Read Holding Registers	CounterRead00		CounterRead	%IW11883	ARRAY [0..17] OF WORD		Read Holding Registers
Variable	Mapping	Channel	Address	Type	Unit	Description																														
AnalogWrite01		AnalogWrite	%QW21026	ARRAY [0..1] OF WORD		Write Multiple Registers																														
AnalogRead00		AnalogRead	%IW11874	ARRAY [0..7] OF WORD		Read Holding Registers																														
BinaryRead00		BinaryRead	%IW11882	ARRAY [0..0] OF WORD		Read Holding Registers																														
CounterRead00		CounterRead	%IW11883	ARRAY [0..17] OF WORD		Read Holding Registers																														
3	<p>Changing all variable names in sequence</p> <p>The names of all sensors' variables must be unique within the measuring, control, and automation system.</p>																																			

## 3.3.6 Configuring functional modules

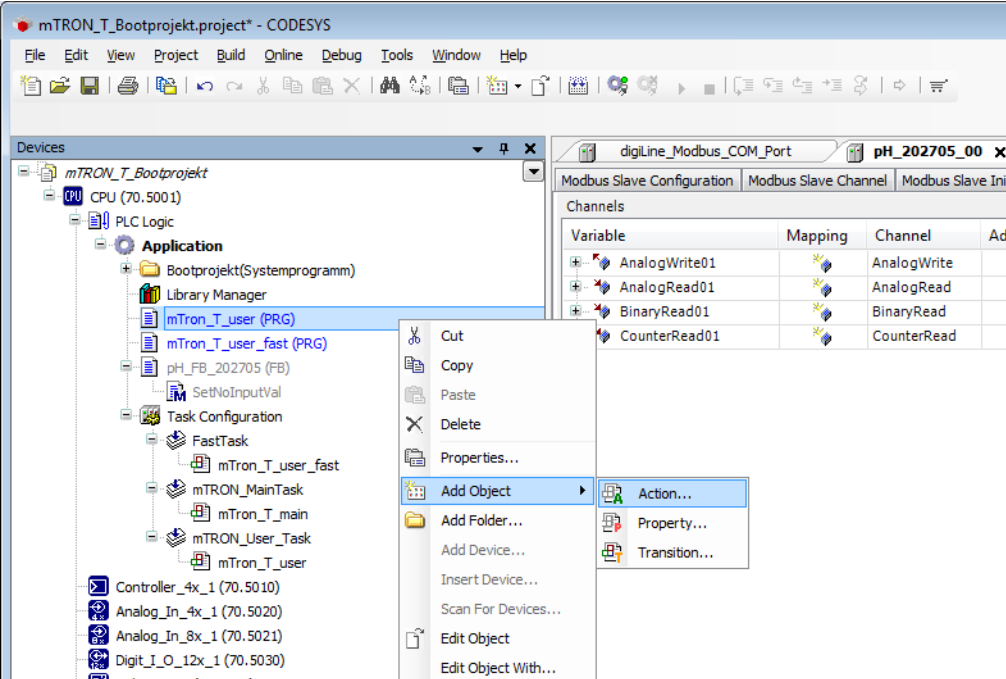
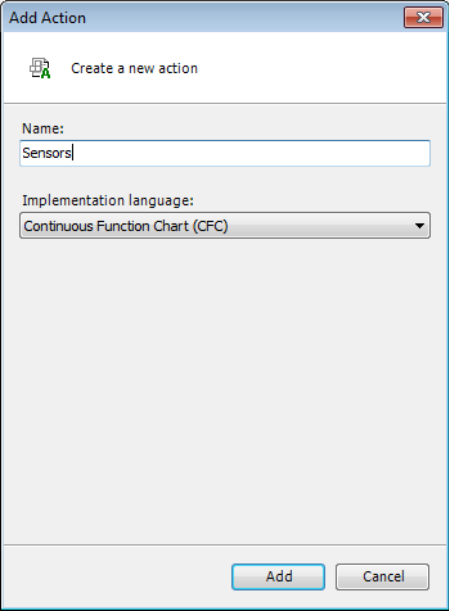
Step	Activity
1	<p>Add an "Action" object under "mTron_T_user" in the device tree (context menu)</p> 
2	<p>Add an object name (here: Sensors), select an implementation language (CFC) and adopt by pressing "Add"</p> 

# 3 Configuration

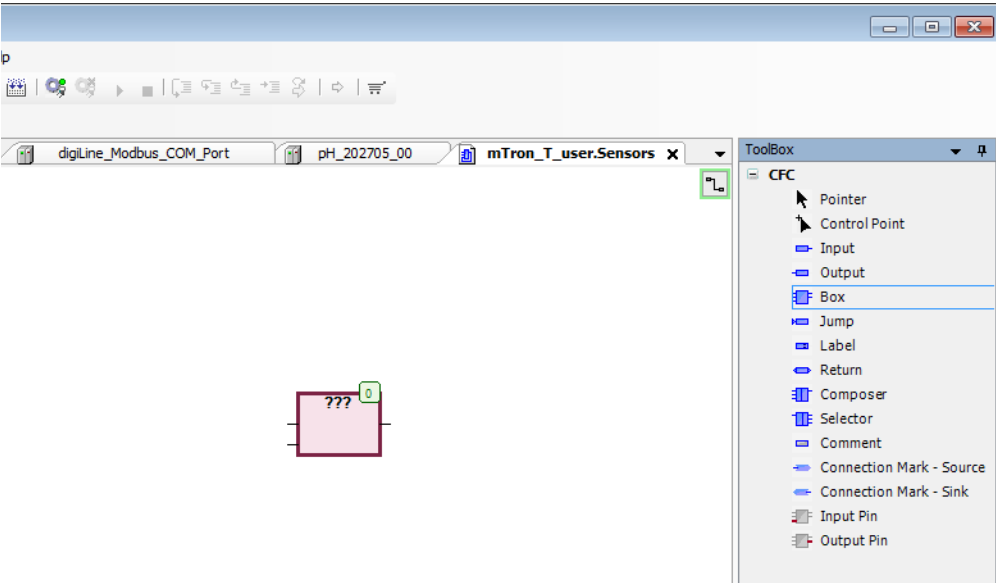
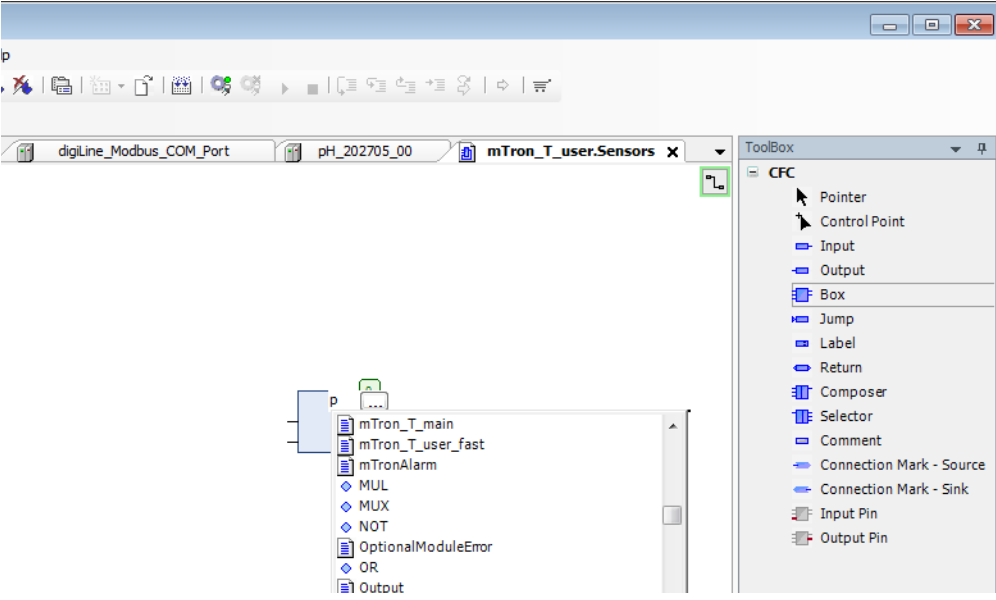
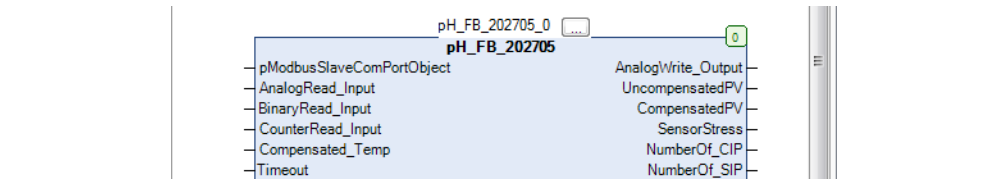
Step	Activity
3	<p>Select and add a module element from the "Toolbox" menu</p> 
4	<p>Instead of "???", add the name of the functional module (here: pH_FB_202705) (or adopt one from the list) and complete the entry by pressing return</p>  <p>? An entity is created automatically and a name is issued (here: pH_FB_202705_0)</p> 

### 3 Configuration

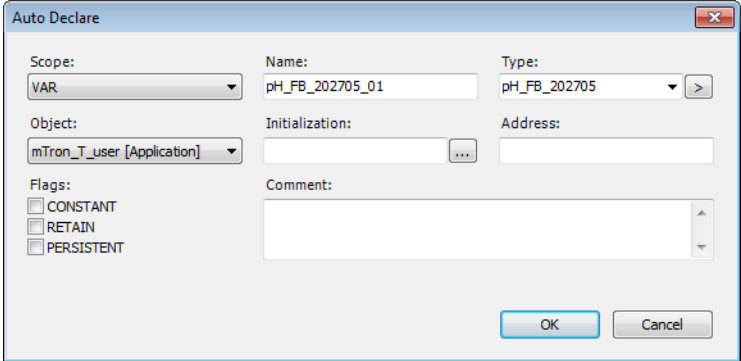
Step	Activity
5	<p>Change the automatic name of the entity so that the automatic suffix (_0) corresponds to the number of the Modbus slave (here: _01) and complete the entry by pressing return</p>  <p>The modified name is: pH_FB_202705_01</p> <p>Important: The name of the entity (here: pH_FB_202705_01) must be different to the name of the Modbus slave (here: pH_202705_01)!</p> <p>&gt; After adopting the new name, the window "Auto Declare" may open.</p>
6	<p>Declare variable: Do not change the settings and accept by pressing "OK"</p> 

# 3 Configuration

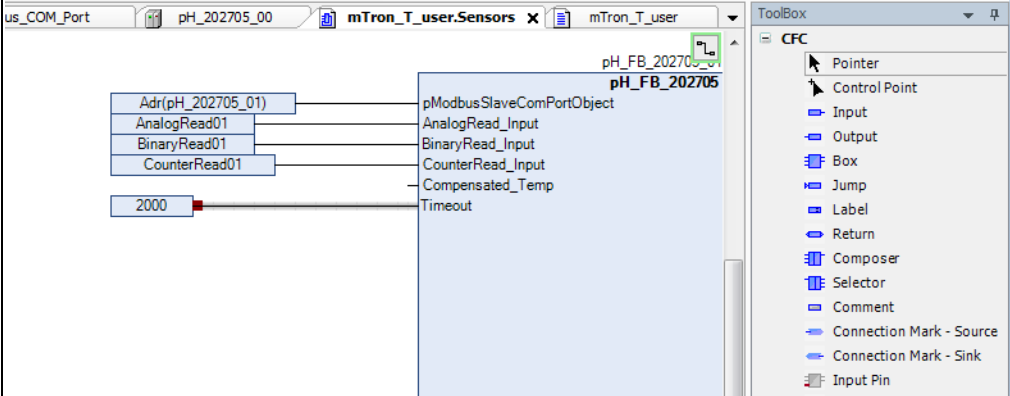
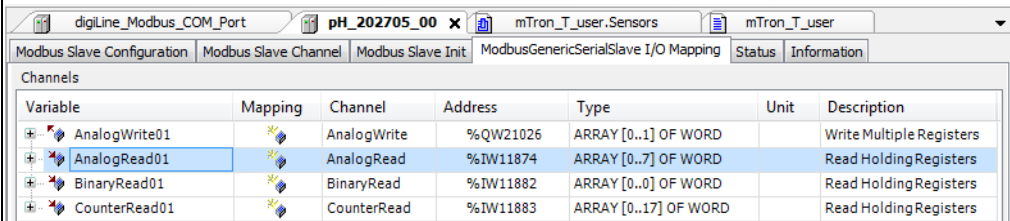
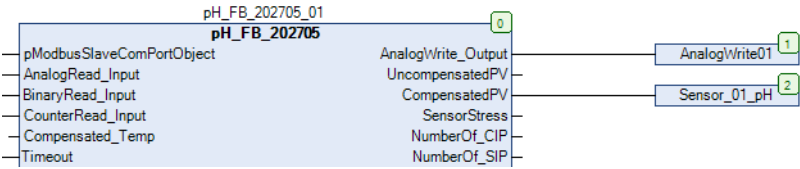
Step	Activity																																			
7	<p>Connecting the entity: Set up the inputs ("Input" tool), enter names (use the names from the I/O mapping, see below), declare the variables if necessary and connect the inputs with the entity</p>  <p>"pModbusSlaveComPortObject" input (= pointer): Adr(name of the Modbus slave); here: Adr(pH_202705_01).</p> <p>"...Read_Input" inputs: Use names from the I/O mapping:</p>  <table border="1"> <thead> <tr> <th>Variable</th> <th>Mapping</th> <th>Channel</th> <th>Address</th> <th>Type</th> <th>Unit</th> <th>Description</th> </tr> </thead> <tbody> <tr> <td>AnalogWrite01</td> <td></td> <td>AnalogWrite</td> <td>%QW21026</td> <td>ARRAY [0..1] OF WORD</td> <td></td> <td>Write Multiple Registers</td> </tr> <tr> <td>AnalogRead01</td> <td></td> <td>AnalogRead</td> <td>%IW11874</td> <td>ARRAY [0..7] OF WORD</td> <td></td> <td>Read Holding Registers</td> </tr> <tr> <td>BinaryRead01</td> <td></td> <td>BinaryRead</td> <td>%IW11882</td> <td>ARRAY [0..0] OF WORD</td> <td></td> <td>Read Holding Registers</td> </tr> <tr> <td>CounterRead01</td> <td></td> <td>CounterRead</td> <td>%IW11883</td> <td>ARRAY [0..17] OF WORD</td> <td></td> <td>Read Holding Registers</td> </tr> </tbody> </table> <p>A timeout of 2000 (ms) per interface must be taken into account for each entity (sensor). A timeout of 4000 is therefore required for two sensors; a timeout of 6000 for three, etc.</p> <p>An explanation of the other inputs can be found in the operating manual for the sensor in question.</p>	Variable	Mapping	Channel	Address	Type	Unit	Description	AnalogWrite01		AnalogWrite	%QW21026	ARRAY [0..1] OF WORD		Write Multiple Registers	AnalogRead01		AnalogRead	%IW11874	ARRAY [0..7] OF WORD		Read Holding Registers	BinaryRead01		BinaryRead	%IW11882	ARRAY [0..0] OF WORD		Read Holding Registers	CounterRead01		CounterRead	%IW11883	ARRAY [0..17] OF WORD		Read Holding Registers
Variable	Mapping	Channel	Address	Type	Unit	Description																														
AnalogWrite01		AnalogWrite	%QW21026	ARRAY [0..1] OF WORD		Write Multiple Registers																														
AnalogRead01		AnalogRead	%IW11874	ARRAY [0..7] OF WORD		Read Holding Registers																														
BinaryRead01		BinaryRead	%IW11882	ARRAY [0..0] OF WORD		Read Holding Registers																														
CounterRead01		CounterRead	%IW11883	ARRAY [0..17] OF WORD		Read Holding Registers																														
8	<p>Set up the outputs in the same way</p>  <p>The "AnalogWrite_Output" output is connected as shown (use the name from the I/O mapping); however, this is not of any further significance for the user (data is transmitted to the sensor).</p> <p>The "CompensatedPV" output is used in this example; this supplies the pH value measured by the sensor.</p> <p>An explanation of the other outputs can be found in the operating manual for the sensor in question.</p>																																			

Step	Activity
9	<p data-bbox="395 282 1358 309">Double click "mTron_T_user" program to open it and call up the "Sensors" action</p> <pre data-bbox="411 331 1374 481">MAIN_Counter := MAIN_Counter + 1;  // Version number SetVersionString(versionType:= J705001SYS.VERSION_STRING_TYPE.eVersionBootproject, wsVersion:= "294.4.1"); SetVersionString(versionType:= J705001SYS.VERSION_STRING_TYPE.eVersionApplication, wsVersion:= "1.00");  Sensors();</pre>

# 3 Configuration

## 3.3.7 Mapping the outputs

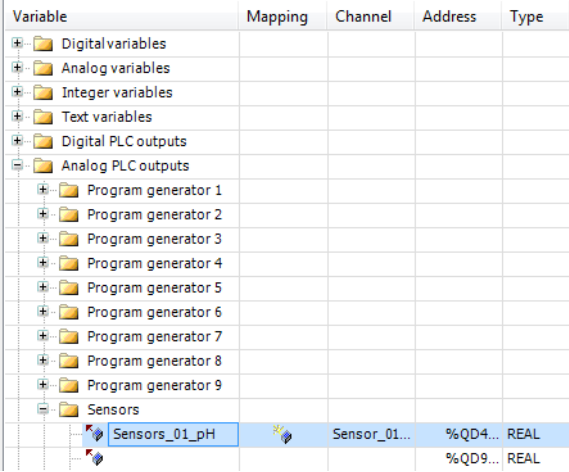
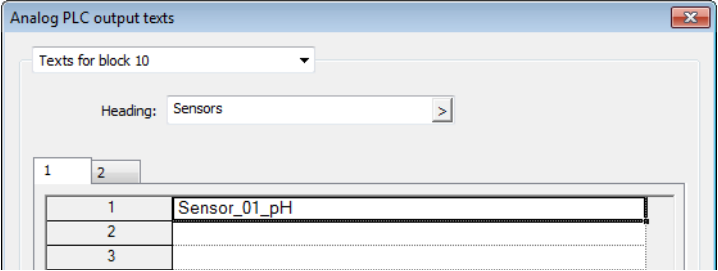
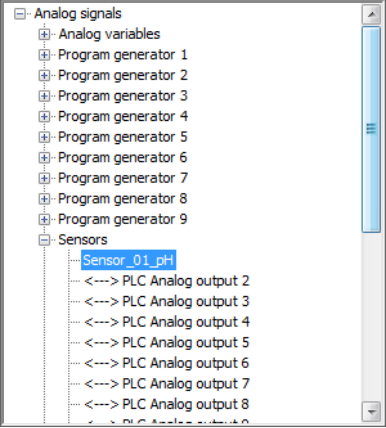
Step	Activity
1	<p>Map the entity's outputs in the CPU's I/O mapping (here: "Sensor_01_pH" variable)</p>  <p>Important information: The heading (here: Sensors) and signal names in the "Channel" column (here: Sensor_01_pH) are issued in advance in the setup program (CPU &gt; Only setup &gt; Analog PLC output texts):</p> 
2	<p>After completing the project in CODESYS, the outputs are available for configuration in the setup program within the selectors:</p> 





**JUMO GmbH & Co. KG**

Street address:  
Moritz-Juchheim-Straße 1  
36039 Fulda, Germany

Delivery address:  
Mackenrodtstraße 14  
36039 Fulda, Germany

Postal address:  
36035 Fulda, Germany

Phone: +49 661 6003-0  
Fax: +49 661 6003-607  
Email: [mail@jumo.net](mailto:mail@jumo.net)  
Internet: [www.jumo.net](http://www.jumo.net)

**JUMO UK LTD**

JUMO House  
Temple Bank, Riverway  
Harlow, Essex, CM20 2DY, UK

Phone: +44 1279 63 55 33  
Fax: +44 1279 62 50 29  
Email: [sales@jumo.co.uk](mailto:sales@jumo.co.uk)  
Internet: [www.jumo.co.uk](http://www.jumo.co.uk)

**JUMO Process Control, Inc.**

6724 Joy Road  
East Syracuse, NY 13057, USA

Phone: +1 315 437 5866  
Fax: +1 315 437 5860  
Email: [info.us@jumo.net](mailto:info.us@jumo.net)  
Internet: [www.jumousa.com](http://www.jumousa.com)

