

Inkopplingsanvisning för Temperaturgivare med kopplingshuvud

Givare med kopplingshuvud Form "J"

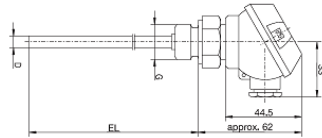

1x RTD 3-led

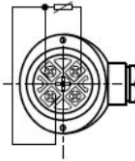

1x RTD 4-led

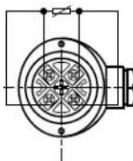

1x RTD 2-led
1x Termoelement



2x RTD 2-led
2x Termoelement

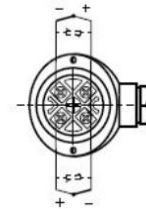

Resistansdiagram för Pt100

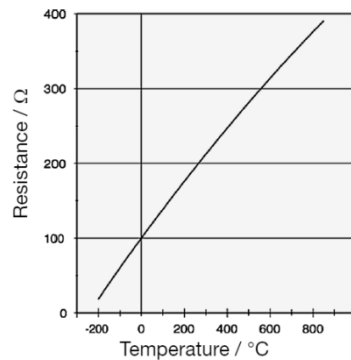

Givare med kopplingshuvud Form "B"

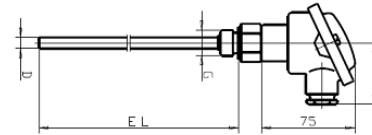

1x RTD 2-led, eller
1x Termoelement

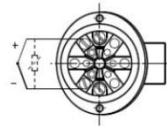

1x RTD 4-led

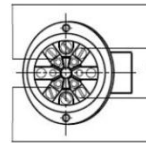

2x RTD 2-led, eller
2x Termoelement

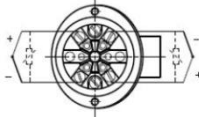

1x RTD 3-led

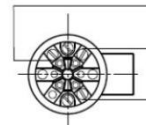

3x RTD 2-led, eller
3x Termoelement

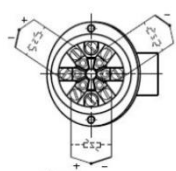

2x RTD 3-led

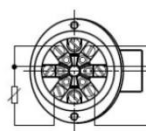

2x RTD 4-led

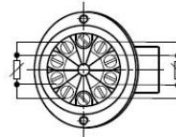

Givare med kopplingshuvud Form "A"

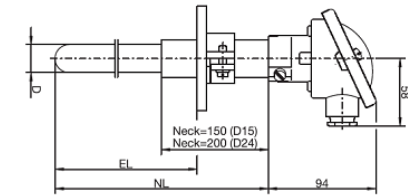

1x Termoelement

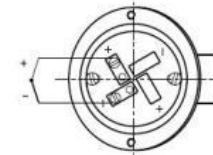

2x Termoelement

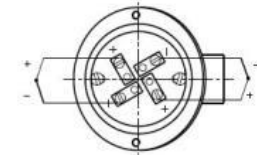

2x Termoelement (Typ "S", "B" & "R")

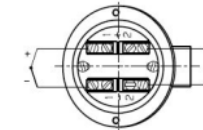

Färgkodning på Termoelement

Termoelement	Positiv pol	Negativ pol
Fe-CuNi	"J"	Svart
Cu-CuNi	"T"	Brun
NiCr-Ni	"K"	Grön
NiCr-CuNi	"E"	Violett
NiCrSi-NiSi	"N"	Rosa
Pt10Rh-Pt	"S"	Orange
Pt13Rh-Pt	"R"	Orange
Pt30Rh-Pt6Rh	"B"	-----
Fe-CuNi	"L"	Röd
Cu-CuNi	"U"	Röd

Inkopplingsanvisning för Temperaturgivare med kopplingshuvud

More than **sensors + automation**

Givare med kopplingshuvud & M12 kontakt

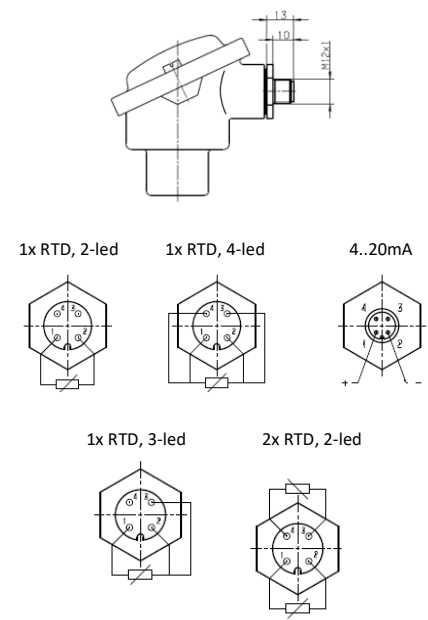

Givare med kopplingshuvud & Transmitter

Form J

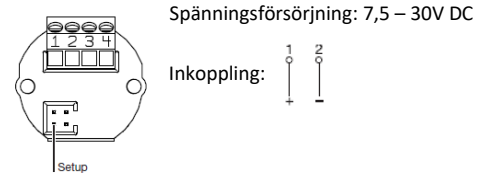

Form A & B

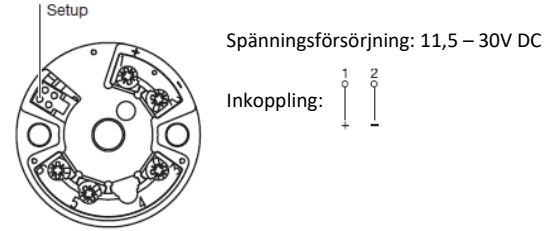

Inkopplingsexempel (loopmatning):

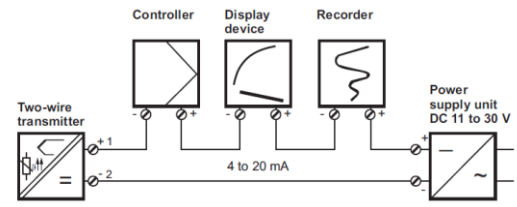

Visste du att du kan få dina givare med kalibreringsprotokoll direkt från fabriken?

Vi kan även leverera givare med en mängd olika godkännanden för olika branscher.



Kontakta någon av våra säljare för mer information.

Försäljning
Telefon: +46 42 38 62 77
E-mail : sales.se@jumo.net

Om ni behöver konfigureringshjälp eller annan teknisk support är ni varmt välkomna att höra av er till oss.

Vi kan även erbjuda stöd vid regler tekniska frågeställningar samt upprättande av elritningar i CAD.

Teknisk support
Telefon: +46 42 38 62 75
E-mail : service.se@jumo.net