

JUMO dTRANS T08 14

Universal transmitter

707114

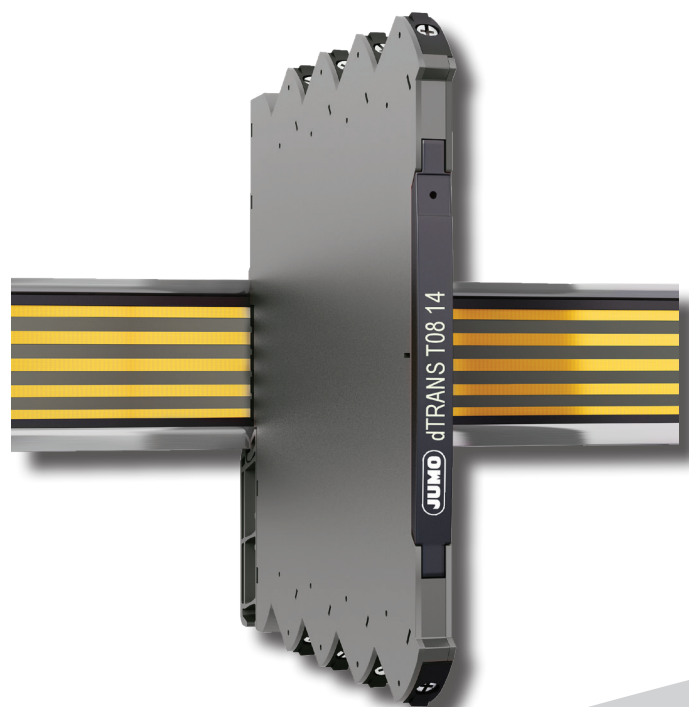

Operating Manual

70711400T90Z001K000

V1.00/EN/00699034



Universal transmitter

JUMO dTRANS T08 14

Table of contents

Warning	3
Symbol identification	3
Safety instructions	3
Flexible supply	6
Mounting and demounting of JUMO dTRANS T/S08	7
Installation on DIN rail / power rail	8
Supply of power rail	8
Marking	8
Side label	9
Advanced features	10
Applications	10
Technical characteristics	10
Product overview	10
Display/programming front for dTRANS T08 14 (TN: 00697616)	11
Docking station for BD 08 14 (TN: 00697617)	11
Order	12
Accessories	12
Technical data	12
Display readout on the Display/programming front for dTRANS T08 14 (TN: 00697616) of sensor error detection and input signal outside range	16
Sensor error detection limits	16
Error indications	17
Connections	18
LED indication	19
Default configuration	20
Configuration / operating the function keys	21
Routing diagram	24
Routing diagram, advanced settings (ADV.SET)	25
Help text overview	26

Warning



GENERAL

To avoid the risk of electric shock and fire, the safety instructions of this guide must be observed and the guidelines followed. The specifications must not be exceeded, and the device must only be applied as described in the following. Prior to the commissioning of the device, this installation guide must be examined carefully. Only qualified personnel (technicians) should install this device. If the equipment is used in a manner not specified by the manufacturer, the protection provided by the equipment may be impaired. Until the device is fixed, do not connect hazardous voltages to the device.

To avoid explosion and serious injury: Modules having mechanical failures must be returned to JUMO GmbH & Co. KG for repair or replacement.

Repair of the device must be done by JUMO GmbH & Co. KG only.

Warning



**HAZARDOUS
VOLTAGE**

In applications where hazardous voltage is connected to in-/outputs of the device, sufficient spacing or isolation from wires, terminals and enclosure - to surroundings (incl. neighboring devices), must be ensured to maintain protection against electric shock.

The connector behind the front cover of JUMO dTRANS T08 14 is connected to the input terminals on which dangerous voltages can occur.



CAUTION

Potential electrostatic charging hazard. To avoid the risk of explosion due to electrostatic charging of the enclosure, do not handle the units unless the area is known to be safe, or appropriate safety measures are taken to avoid electrostatic discharge.

Symbol identification



Triangle with an exclamation mark: Read the manual before installation and commissioning of the device in order to avoid incidents that could lead to personal injury or mechanical damage.



The CE mark proves the compliance of the device with the essential requirements of the directives.



Ex devices have been approved acc. to the ATEX directive for use in connection with installations in explosive areas.

Safety instructions

Receipt and unpacking

Unpack the device without damaging it and check whether the device type corresponds to the one ordered. The packing should always follow the device until this has been permanently mounted.

Environment

Avoid direct sun light, dust, high temperatures, mechanical vibrations and shock, and rain and heavy moisture. If necessary, heating in excess of the stated limits for ambient temperatures should be avoided by way of ventilation.

The device can be used for Measurement Category II and Pollution Degree 2.

The device is designed to be safe at least under an altitude up to 2 000 m.

Mounting

Only technicians who are familiar with the technical terms, warnings, and instructions in the manual and who are able to follow these should connect the device.

Should there be any doubt as to the correct handling of the device, please contact your local distributor or, alternatively,
JUMO GmbH & Co. KG
www.jumo.net

Mounting and connection of the device should comply with national legislation for mounting of electric materials, i.e. wire cross section, protective fuse, and location.

Descriptions of input / output and supply connections are shown in this installation guide and on the side label.

The device is provided with field wiring terminals and shall be supplied from a Power Supply having double / reinforced insulation. A power switch should be easily accessible and close to the device. The power switch shall be marked as the disconnecting unit for the device.

JUMO dTRANS T/S08 must be mounted on a DIN rail according to EN 60715.

UL installation

Use 60/75°C copper conductors only.

Wire size. AWG 26-12

UL file number E201387

The device is an Open Type Listed Process Control Equipment. To prevent injury resulting from accessibility to live parts the equipment must be installed in an enclosure.

The power Supply unit must comply with NEC Class 2, as described by the National Electrical Code® (ANSI / NFPA 70).

IECEX, ATEX installation in Zone 2

IECEX DEK 18.0006 X Ex nA IIC T4 Gc

DEKRA 18ATEX0007 X II 3G Ex nA IIC T4 Gc

For safe installation the following must be observed. The device shall only be installed by qualified personnel who are familiar with the national and international laws, directives and standards that apply to this area.

Year of manufacture can be taken from the first two digits in the serial number.

The devices shall be installed in a suitable enclosure providing a degree of protection of at least IP54 according to EN60529, taking into account the environmental conditions under which the equipment will be used.

When the temperature under rated conditions exceeds 70°C at the cable or conduit entry point, or 80°C at the branching point of the conductors, the temperature specification of the selected cable shall be in compliance with the actual measured temperature.

Provisions shall be made to prevent the rated voltage from being exceeded by transient disturbances of more than 40%.

For installation on power rail in Zone 2, only Power rail profile (7.5 mm / 750 mm) (TN: 00697614) supplied by Power connector unit for dTRANS T/S08 XX (TN: 00697612) is allowed.

To prevent ignition of the explosive atmospheres, disconnect power before servicing and do not separate connectors when energised and an explosive gas mixture is present.

Do not mount or remove devices from the power rail when an explosive gas mixture is present.

Cleaning

When disconnected, the device may be cleaned with a cloth moistened with distilled water.

Liability

To the extent the instructions in this manual are not strictly observed, the customer cannot advance a demand against JUMO GmbH & Co. KG that would otherwise exist according to the concluded sales agreement.

Flexible supply

The technical specifications specifies the maximum required power at nominal operating values, e.g. 24 V supply voltage, 70°C ambient temperature, 600 Ω load, and 20 mA output current.

DIN rail solution - device daisy chain:

The units can be supplied with 24 VDC \pm 30% via direct wiring and a loop between the devices.

Protective fuse: 2.5 A.*

Power rail solution #2:

The JUMO dTRANS T/S08 PCU power connector unit allows easy connection of a 24 VDC / 2.5 A source to the power rail.

Protective fuse: 2.5 A.*

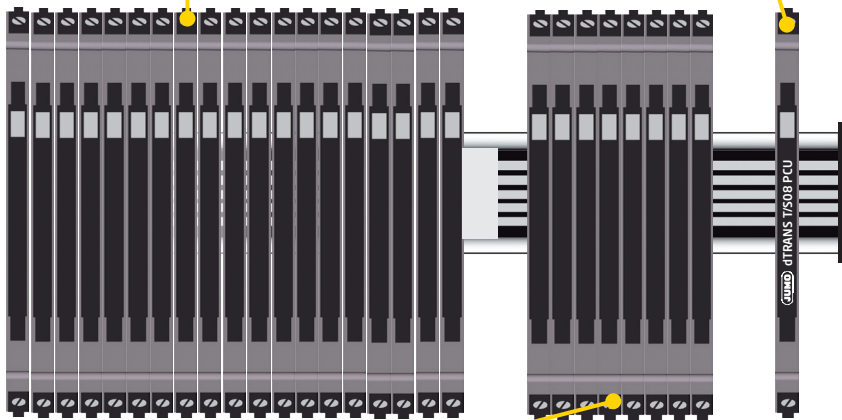

Protective fuse: 0.4 A.

Power rail solution #1:

Alternately, you can connect 24 VDC to any one JUMO dTRANS T/S08 device with power rail connector which will then energize other units on the rail.

(*) External fuse characteristics:

The 2.5 A fuse must break after not more than 120 seconds at 6.4 A.

Mounting and demounting of JUMO dTRANS T/S08

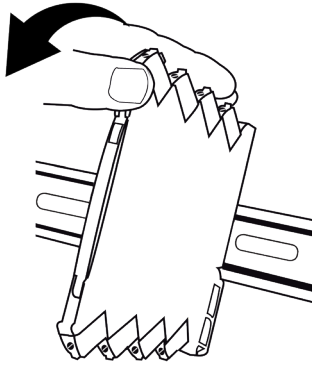

Picture 1:
Mounting on DIN rail / power rail.
Click the device onto the rail.

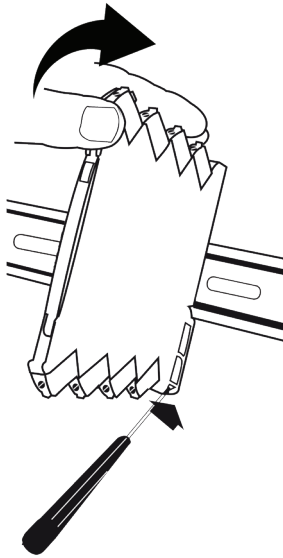

Picture 2:
Demounting from DIN rail / power rail.
First, remember to demount the connectors with hazardous voltages.
Detach the device from the DIN rail by lifting the bottom lock.

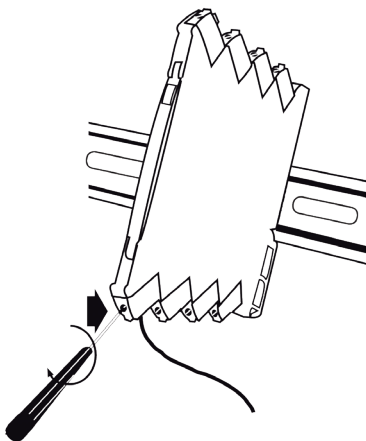

Picture 3:
Wire size AWG 26-12 / 0.13 x 2.5 mm² stranded wire.
Screw terminal torque 0.5 Nm.

Installation on DIN rail / power rail

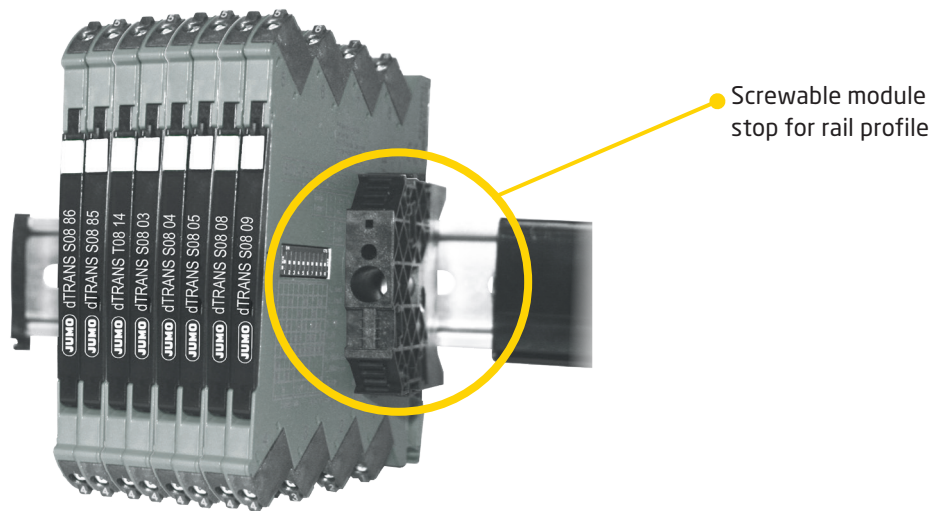

JUMO dTRANS T08 14 can be installed on a DIN rail or on a power rail. For marine applications the devices must be supported by a module stop (TN: 00697615). Power supply units can be mounted on the power rail according to customer requirements.

If you want to install a JUMO dTRANS T08 14 device with power rail connectors on a standard DIN rail, the head of the screws holding the 7.5 mm DIN rail shall be no more than 3.5 mm high in order to avoid short circuit between the power rail connectors on the device and the screws.

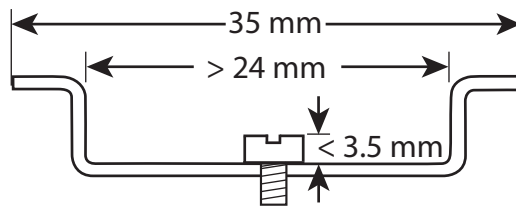

Supply of power rail

It is possible to supply the power rail via the supply terminals. The terminals can pass a current of max. 400 mA.

Marking

The front cover of the JUMO dTRANS T/S08 devices has been designed with an area for affixation of a click-on marker. The area assigned to the marker measures 5 x 7.5 mm. Markers from Weidmüller's MultiCard System, type MF 5/7.5, are suitable.

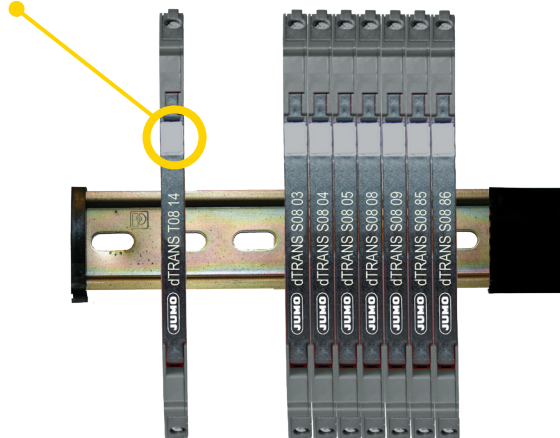

Side label

JUMO JUMO GmbH & Co. KG
Moritz-Juchheim-Straße 1
36039 Fulda, Germany
www.jumo.net

CE DNV-GL

Universal transmitter

TC-	V+	+4w	pot.2	Loop+	4	5	mA+	V+
TC+	V-	2w/+3w/+4w	pot.3	Loop-	3	6	mA-	V-
		2w/-3w/-4w	pot.1		2	7	Supply+	24 V ±30%
		1-3w/-4w			1	8	Supply-	1.2W

Power Rail

JUMO dTRANS T08 14
707114
TN: 00697476

IECEX Ex nA IIC T4 Gc
IECEX DEK 18.0006X

Ex II 3 G Ex nA IIC T4 Gc
DEKRA 18ATEX0007X

UL LISTED OPEN-TYPE PROCESS CONTROL EQUIPMENT
E201387

-25°C < Ta < +70°C

123456789

Universal transmitter

JUMO dTRANS T08 14

- Input for RTD, TC, Ohm, potentiometer, mA and V
- 2-wire supply > 15 V
- I.S. approvals: ATEX Zone 2, IECEx Zone 2
- Output for current and voltage

Advanced features

Programmable by way of detachable display/programming front for dTRANS T08 14 (TN: 00697616) and docking station for BD 08 14 (TN: 00697617), process calibration, signal simulation, password protection, error diagnostics and help text available in several languages.

Applications

- Linearised, electronic temperature measurement with RTD or TC sensor.
- Conversion of linear resistance variation to a standard analogue current / voltage signal, i.e. from solenoids and butterfly valves or linear movements with attached potentiometer.
- Power supply and signal isolator for 2-wire transmitters.
- Process control with standard analog output.
- Galvanic separation of analogue signals and measurement of floating signals.

Technical characteristics

- When JUMO dTRANS T08 14 is used in combination with the display/programming front for dTRANS T08 14 (TN: 00697616) and docking station for BD 08 14 (TN: 00697617), all operational parameters can be modified to suit any application. As the JUMO dTRANS T08 14 is designed with electronic hardware switches, it is not necessary to open the device for setting of DIP-switches.
- A green front LED indicates normal operation and malfunction.
- Continuous check of vital stored data for safety reasons.
- 3-port 2.5 kVAC galvanic isolation.

Product overview

Type	JUMO dTRANS T08 14
Product name	Universal transmitter
Description	Universal DC / DC and temperature converter with loop supply output
Parameterisation	Display/programming front for dTRANS T08 14 (TN: 00697616) / Docking station for BD 08 14 (TN: 00697617)
Input signal	RTD, TC and potentiometer 2-, 3-, and 4-wire 0...10 V 0...20 mA
Sensor type	All standard Pt, Ni, TC
CJC sensor	Internal Pt100
Loop supply output	> 15 V @ 20 mA
Output signal (active)	0...20 mA / 0...10 V
Approvals	UL, safety / ATEX zone 2 / IECEx Zone 2 / DNV-GL

Display/programming front for dTRANS T08 14 (TN: 00697616)



Functionality

The simple and easily understandable menu structure and the explanatory help texts guide you effortlessly and automatically through the configuration steps, thus making the product very easy to use. Functions and configuration options are described in the section "Configuration / operating the function keys".

Application

- Communications interface for modification of operational parameters in JUMO dTRANS T08 14.
- Can be moved from one JUMO dTRANS T08 14 device to another and download the configuration of the first unit to subsequent units.

Technical characteristics

- LCD display with 4 lines:
 - Line 1 (H=5.57 mm) shows input signal.
 - Line 2 (H=3.33 mm) shows units.
 - Line 3 (H=3.33 mm) shows analog output or tag no.
 - Line 4 shows communication status.
- Programming access can be blocked by assigning a password. The password is saved in the device in order to ensure a high degree of protection against unauthorised modifications to the configuration.

Docking station for BD 08 14 (TN: 00697617)

Connect the adapter by opening the front plate on JUMO dTRANS T08 14 and inserting the jack into the plug.

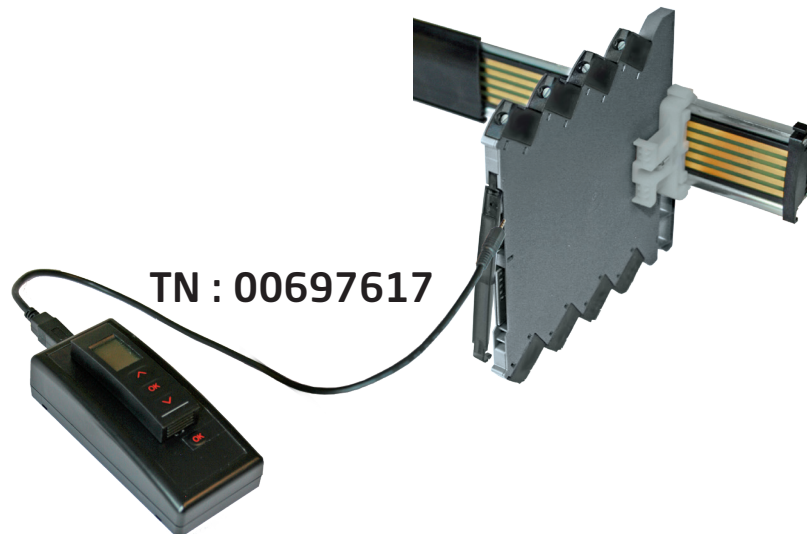

Order

Type	Product name	Description	Order code
707114	JUMO dTRANS T08 14	Universal transmitter	00697476

Accessories

TN: 00697616 = Display/programming front for dTRANS T08 14

TN: 00697617 = Docking station for BD 08 14

TN: 00697615 = Screwable module stop for rail profile

Technical data

Environmental conditions:

Operating temperature -25°C to +70°C
Storage temperature -40°C to +85°C
Calibration temperature 20...28°C
Relative humidity < 95% RH (non-cond.)
Protection degree IP20
Installation in pollution degree 2 & overvoltage category II.

Mechanical specifications:

Dimensions (HxWxD) 113 x 6.1 x 115 mm
Weight approx. 70 g
DIN rail type. DIN EN 60715 - 35 mm
Wire size. 0.13...2.5 mm² / AWG 26...12 stranded wire
Screw terminal torque. 0.5 Nm
Vibration. IEC 60068-2-6
2...25 Hz. ±1.6 mm
25...100 Hz ±4 g

Common electrical specifications:

Supply voltage, universal. 16.8...31.2 VDC
Max. required power 1.2 W
Max. power dissipation 0.65 W
Max. required power is the maximum power needed at power supply terminals or rail connector.
Max. power dissipation is the maximum power dissipated at nominal operating values.
Fuse 400 mA SB / 250 VAC
Isolation voltage, test / working. 2.5 kVAC / 300 VAC (250 VAC (Ex))
Programming Display/programming front for dTRANS T08 14 (TN:
00697616) / Docking station for BD 08 14 (TN:
00697617)
Signal dynamics, input / output 24 bit / 16 bit
Signal / noise ratio Min. 60 dB (0...100 kHz)
Response time (0...90%, 100...10%):
Temperature input 1 s
mA / V input 400 ms

Accuracy, the greater of the general and basic values:

General values		
Input type	Absolute accuracy	Temperature coefficient
All	$\leq \pm 0.1\%$ of span	$\leq \pm 0.01\%$ of span / °C

Basic values		
Input type	Basic accuracy	Temperature coefficient
mA	$\leq \pm 16 \mu\text{A}$	$\leq \pm 1.6 \mu\text{A} / ^\circ\text{C}$
0...1 V & 0.2...1 V	$\leq \pm 0.8 \text{ mV}$	$\leq \pm 0.08 \text{ mV} / ^\circ\text{C}$
0...5 V, 1...5 V, 0...10 V & 2...10 V	$\leq \pm 8 \text{ mV}$	$\leq \pm 0.8 \text{ mV} / ^\circ\text{C}$
Pt100, Pt200, Pt 1000	$\leq \pm 0.2^\circ\text{C}$	$\leq \pm 0.02^\circ\text{C} / ^\circ\text{C}$
Pt500, Ni100, Ni120, Ni 1000	$\leq \pm 0.3^\circ\text{C}$	$\leq \pm 0.03^\circ\text{C} / ^\circ\text{C}$
Pt50, Pt400, Ni50	$\leq \pm 0.4^\circ\text{C}$	$\leq \pm 0.04^\circ\text{C} / ^\circ\text{C}$
Pt250, Pt300	$\leq \pm 0.6^\circ\text{C}$	$\leq \pm 0.06^\circ\text{C} / ^\circ\text{C}$
Pt20	$\leq \pm 0.8^\circ\text{C}$	$\leq \pm 0.08^\circ\text{C} / ^\circ\text{C}$
Pt10	$\leq \pm 1.4^\circ\text{C}$	$\leq \pm 0.14^\circ\text{C} / ^\circ\text{C}$
TC type: E, J, K, L, N, T, U	$\leq \pm 1^\circ\text{C}$	$\leq \pm 0.1^\circ\text{C} / ^\circ\text{C}$
TC type: R, S, W3, W5, LR	$\leq \pm 2^\circ\text{C}$	$\leq \pm 0.2^\circ\text{C} / ^\circ\text{C}$
TC type: B 160...400°C	$\leq \pm 4.5^\circ\text{C}$	$\leq \pm 0.45^\circ\text{C} / ^\circ\text{C}$
TC type: B 400...1820°C	$\leq \pm 2^\circ\text{C}$	$\leq \pm 0.2^\circ\text{C} / ^\circ\text{C}$

Conducted RF/LF immunity influence	$< \pm 0.5\%$ of span
Extended EMC immunity: ESD / HF / Burst / Surge immunity influence	$< \pm 1\%$ of span

Auxiliary supplies:

2-wire supply (terminal 3 and 4) 25...15 VDC / 0...20 mA

RTD, linear resistance and potentiometer input:

Input type	Min. value	Max. value	Standard
Pt100	-200°C	+850°C	IEC 60751
Ni100	-60°C	+250°C	DIN 43760
Linear resist.	0 Ω	10000 Ω	-
Potentiometer	10 Ω	100 kΩ	-

Input for RTD types:

Pt10, Pt20, Pt50, Pt100, Pt200, Pt250, Pt300, Pt400, Pt500, Pt1000

Ni50, Ni100, Ni120, Ni1000

Cable resistance per wire (max.), RTD 50 Ω

Sensor current; RTD Nom. 0.2 mA

Effect of sensor cable resistance (3- / 4-wire), RTD $< 0.002 \Omega / \Omega$

Sensor error detection, RTD Yes
 Short circuit detection, RTD < 15 Ω

TC input:

Type	Min. value	Max. value	Standard
B	0°C	+1820°C	IEC 60584-1
E	-100°C	+1000°C	IEC 60584-1
J	-100°C	+1200°C	IEC 60584-1
K	-180°C	+1372°C	IEC 60584-1
L	-200°C	+900°C	DIN 43710
N	-180°C	+1300°C	IEC 60584-1
R	-50°C	+1760°C	IEC 60584-1
S	-50°C	+1760°C	IEC 60584-1
T	-200°C	+400°C	IEC 60584-1
U	-200°C	+600°C	DIN 43710
W3	0°C	+2300°C	ASTM E988-90
W5	0°C	+2300°C	ASTM E988-90
LR	-200°C	+800°C	GOST 3044-84

Cold junction compensation (CJC):

via internal CJC sensor ±(2.0°C + 0.4°C * Δt)
 Δt = internal temperature - ambient temperature

Sensor error detection, all TC types. Yes

Sensor error current:

when detecting Nom. 2 μA
 else. 0 μA

Current input:

Measurement range 0...23 mA
 Programmable measurement ranges 0...20 and 4...20 mA
 Input resistance Nom. 20 Ω + PTC 50 Ω
 Sensor error detection:
 Loop break 4...20 mA Yes

Voltage input:

Measurement range 0...12 VDC
 Programmable measurement ranges 0...1 / 0.2...1 / 0...5 / 1...5 / 0...10 and 2...10 VDC
 Input resistance Nom. 10 MΩ

Current output:

Signal range (span) 0...23 mA
 Programmable signal ranges 0...20 / 4...20 / 20...0 and 20...4 mA
 Load ≤ 600 Ω
 Load stability ≤ 0.01% of span / 100 Ω
 Sensor error detection 0 / 3.5 / 23 mA / none
 NAMUR NE 43 Upscale/Downscale. 23 mA / 3.5 mA
 Output limitation:
 on 4...20 and 20...4 mA signals 3.8...20.5 mA
 on 0...20 and 20...0 mA signals 0...20.5 mA
 Current limit. ≤ 28 mA

Voltage output:

Signal range. 0...10 VDC
 Programmable signal ranges 0...1 / 0.2...1 / 0...10 / 0...5 / 1...5 /
 2...10 / 1...0 / 1...0.2 / 5...0 / 5...1 /
 10...0 og 10...2 V
 Load (min.) >10 kΩ

of span = of the currently selected measurement range

Observed authority requirements:

EMC 2014/30/EU
LVD 2014/35/EU
RoHS 2011/65/EU

Approvals:

DNV-GL, Ships & Offshore DNVGL-CG-0339
UL, Standard for Safety UL 61010-1
Safe Isolation EN 61140

I.S. / Ex approvals:

ATEX 2014/34/EU DEKRA 18ATEX0007 X
IECEx DEK 18.0006 X

Display readout on the Display/programming front for dTRANS T08 14 (TN: 00697616) of sensor error detection and input signal outside range

Sensor error check:		
Device:	Configuration	Sensor error detection:
JUMO dTRANS T08 14	OUT.ERR=NONE.	OFF
	Else:	ON

Outside range readout (IN.LO, IN.HI): If the valid range of the A/D converter or the polynomial is exceeded			
Input	Range	Readout	Limit
VOLT	0...1 V / 0.2...1 V	IN.LO	< -25 mV
		IN.HI	> 1.2 V
	0...10 V / 2...10 V	IN.LO	< -25 mV
		IN.HI	> 12 V
CURR	0...20 mA / 4...20 mA	IN.LO	< -1.05 mA
		IN.HI	> 25.05 mA
LIN.R	0...800 Ω	IN.LO	< -10 Ω
		IN.HI	> ca. 1075 Ω
	0...10 kΩ	IN.LO	< -10 Ω
		IN.HI	> 11 kΩ
POTM	0...100%	IN.LO	< -0.5 %
		IN.HI	> 100.5 %
TEMP	TC / Pt100	IN.LO	< temperature range -2°C
		IN.HI	> temperature range +2°C

Display readout below min. / above max. (-1999, 9999):			
Input	Range	Readout	Limit
All	All	-1999	Display readout < -1999
		9999	Display readout > 9999

Sensor error detection limits

Sensor error detection (SE.BR, SE.SH):			
Input	Range	Readout	Condition
CURR	Loop break (4...20 mA)	SE.BR	<= 3.6 mA; > = 21 mA
POTM	All, SE.BR on all 3-wire	SE.BR	> ca. 126 kΩ
LIN.R	0...800 Ω	SE.BR	> ca. 875 Ω
	0...10 kΩ	SE.BR	> ca. 11 kΩ
TEMP	TC	SE.BR	> ca. 750 kΩ / (1.25 V)
	RTD, 2-, 3-, and 4-wire No SE.SH for Pt10, Pt20 and Pt50	SE.BR	> ca. 15 kΩ
		SE.SH	< ca. 15 Ω

Error indications

Readout at hardware error		
Error search	Readout	Cause
CJC sensor error - check device temperature	CJ.ER	Defect internal CJC sensor or CJC temperature out of allowed range**
Flash memory error - default configuration is loaded	FL.ER	Error in FLASH (configuration)*
No communication	NO.CO	No communication
Input error - check input connection and reset power	IN.ER	Error levels on measurement inputs*
Programming mode only - no output signal	PROG.	Offline configuration mode (JUMO dTRANS T08 14 powered by communications interface)***
Invalid configuration type or version	TY.ER	Configuration read from EEprom has invalid type or rev. no.
Hardware error	RA.ER	RAM memory error*
Hardware error	EE.ER	EEPROM memory error*
Hardware error	NO.CA	Device not factory-calibrated
Hardware error	AD.ER	A/D converter error*
Hardware error	EF.SU	External Flash error*
Hardware error	IF.ER	Internal Flash error*

!	All error indications in the display flash once per second. The help text explains the error. If the error is a sensor error, the display backlight flashes as well - this is acknowledged (stopped) by pushing the  button.
*	Error is acknowledged by entering the menu and saving or by resetting the device power.
**	Error can be disregarded by selecting input type different than TC.
***	Error indication does not flash. Error is acknowledged by connecting device power.

Connections

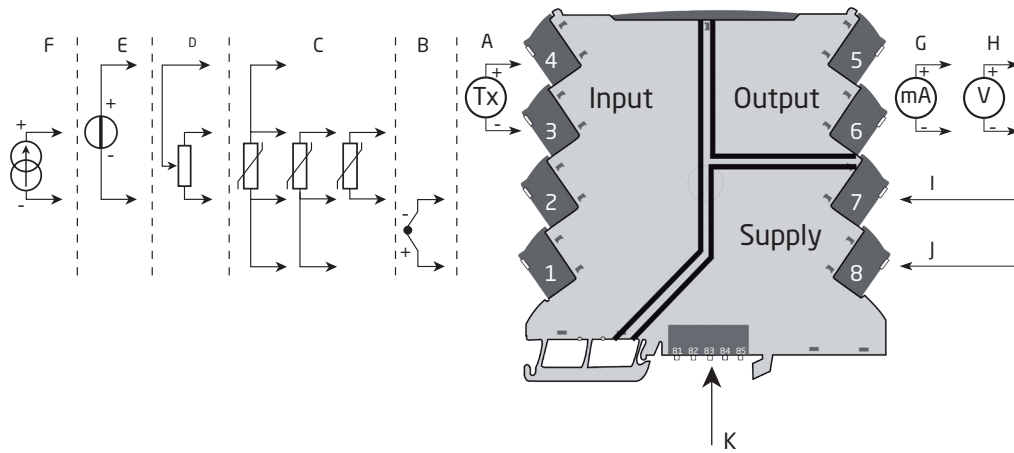

	Input signals
A	Current 1
B	TC
C	RTD
D	Potentiometer
E	Voltage
F	Current 2

	Output signals
G	Current
H	Voltage

	Supply
I	Supply +
J	Supply -
K	Power rail connections

LED indication

The device is equipped with a green power LED in the front to indicate the operation status, see the table below.



Condition	LED	Output and loop supply	Action required
No supply / device error or code-flash CRC error	OFF	De-energized	Connect supply / replace device
Power-up or restart	1 Flash (0.5 s OFF + 0.5 s ON)	De-energized	-
Device OK	Flashing 13 Hz (15 ms ON)	Energized	-
Sensor error	Flashing 1 Hz (15 ms ON)	De-energized	Correct setting and re-power device
Restarting due to: Supply error/hardware. RAM or program flow error	Flashing 1 Hz (0.5 s ON)	De-energized	Adjust supply / replace device

Default configuration

Input

Input type Temperature
Voltage input 0...10 V
Current input 4...20 mA
Sensor connection (RTD+resistance) 3 wire
R input range 0...1000
Temperature unit. °C
Temperature type Pt
Pt type. Pt100
Ni type. Ni100
TC type K
Display unit °C
Decimal point 000.0
Display low 0.0
Display high. 100.0

Output

Output type. Current
Voltage output 0...10 V
Current output 4...20 mA
Analogue out on error. 23 mA
Analogue out low 0
Analogue out high 150
Output limit. No

Advanced

LCD contrast 3
LCD backlight 4
TAG TAG NO.
Line 3 function Analog out
Use calibration No
Enable password protection No
Calibration range 0.0 / 100.0
Calibration point 0.0 / 100.0
Language UK

Configuration / operating the function keys

Documentation for routing diagram.

In general

When configuring the JUMO dTRANS T08 14, you will be guided through all parameters and you can choose the settings which fit the application. For each menu there is a scrolling help text which is automatically shown in line 3 on the display.

Configuration is carried out by using the 3 function keys:

- ⊞ will increase the numerical value or choose the next parameter
- ⊟ will decrease the numerical value or choose the previous parameter
- ⊞ will accept the chosen value and proceed to the next menu

When configuration is completed, the display will return to the default state 1.0.

Pressing and holding ⊞ will return to the previous menu or return to the default state (1.0) without saving the changed values or parameters.

If no key is activated for 1 minute, the display will return to the default state (1.0) without saving the changed values or parameters.

Further explanations

Password protection: Programming access can be blocked by assigning a password. The password is saved in the transmitter in order to ensure a high degree of protection against unauthorised modifications to the configuration.

Default password 2008 allows access to all configuration menus.

Signal and sensor error info via Display/programming front for dTRANS T08 14 (TN: 00697616)

Sensor error (see limits in the table) is displayed as SE.BR (sensor break) or SE.SH (sensor short). Signals outside the selected range (not sensor error, see table for limits) are displayed as IN.LO indicating low input signal or IN.HI indicating high input signal. The error indication is displayed in line 3 as text and at the same time the backlight flashes. Line 4 of the display is a status line which displays COM (flashing bullet) indicating correct functioning of Display/programming front, and arrow up/down which indicates tendency readout of the input signal.

Signal and sensor error indication without display front

Status of the unit can also be read from the green LED in the front of the device.

Green flashing LED 13 Hz indicates normal operation.

Green flashing LED 1 Hz indicates sensor error.

No light in the LED indicates internal error.

Advanced functions

The unit gives access to a number of advanced functions which can be reached by answering "Yes" to the point "adv.set".

Display setup: Here you can adjust the brightness contrast and the backlight. Setup of TAG number with 6 alphanumeric. Selection of functional readout in line 3 of the display - choose between readout of analog output or TAG number.

Two-point process calibration: The unit can be process-calibrated in 2 points to fit a given input signal. A low input signal (not necessarily 0%) is applied and the actual value is entered via Display/programming front. Then a high signal (not necessarily 100%) is applied and the actual value is entered via Display/programming front. If you accept to use the calibration, the unit will work according to this new adjustment. If you later reject this menu point or choose another type of input signal the unit will return to factory calibration.

Process simulation function: If you say "yes" to the point "EN.SIM" it is possible to simulate an input signal by means of the arrow keys and thus control the output signal up or down. When you finalise the point with 3, the unit returns to normal mode.

Password: Here you can choose a password between 0000 and 9999 in order to protect the unit against unauthorised modifications to the configuration. The unit is delivered default without password. If you have locked the unit with a password by mistake, you can always open the menu by using the master password 2008.

Language: In the menu "lang.setup" you can choose between 7 different language versions of help texts that will appear in the menu. You can choose between UK, DE, FR, IT, ES, SE and DK.

Selection of units

After choosing the input signal type you can choose the process units which will be displayed in text line 2 (see table). By selection of temperature input the process value is always displayed in Celsius or Fahrenheit. This is selected in the menu point after selection of temperature input.

Memory

In the memory menu you can save the configuration of the device in the Display/programming front for dTRANS T08 14 (TN: 00697616), and then move the Display/programming front onto another device of the same type and download the configuration in the new device.

Power up

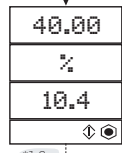

*1.0



*1.1

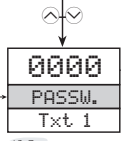
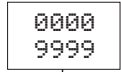

*1.2

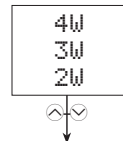
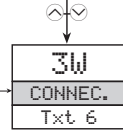
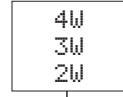
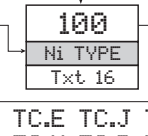
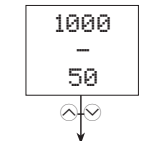
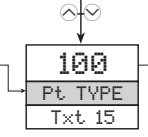
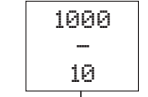
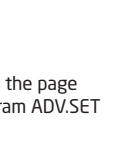
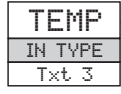
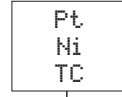
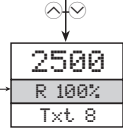
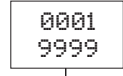
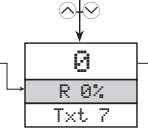
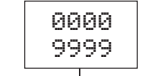
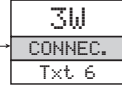
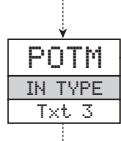
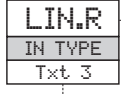
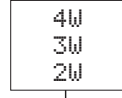
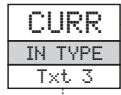
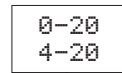
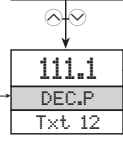
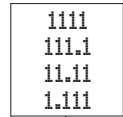
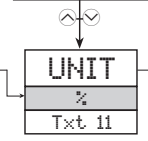
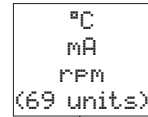
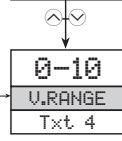
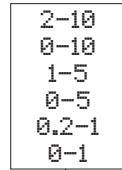
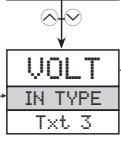
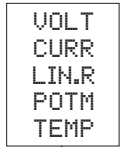
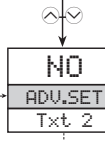
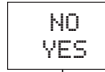

TC.B TC.E TC.J TC.K
TC.L TC.N TC.R TC.S
TC.T TC.U TC.W3
TC.W5 TC.Lr

Continued on the page
Routing diagram ADV.SET

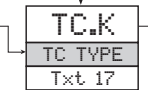
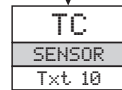
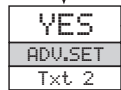

*1.0 Default state
Line 1 shows input signal.
Line 2 shows UNIT.
By pressing ^ and v simultaneously line 3 alternates
between A.Out and TAG.
Line 4 shows communication status.

*1.1 The Display/programming front for dTRANS T08 14 (TN:
00697616) will power off if no key is activated for 1
minute.

*1.2 Only if password is enabled.

*1.3 Downscale to 0 mA / 3.5 mA or 0 V.
Upscale to 23 mA or 110% of Vout high.
Only if input type supports sensor error check.
Not valid for these input signals:
0...20 mA and voltage.

*1.4 Only if input signal is temperature.

Routing diagram

If no key is activated for 1 minute, the display will return to the default state 1.0 without saving configuration changes.

- ⏴ Increase value / choose next parameter
- ⏵ Decrease value / choose previous parameter
- ⏹ Save the chosen value and proceed to the next menu
- ⏪ Hold ⏪ Back to previous menu / return to menu 1.0 without saving.

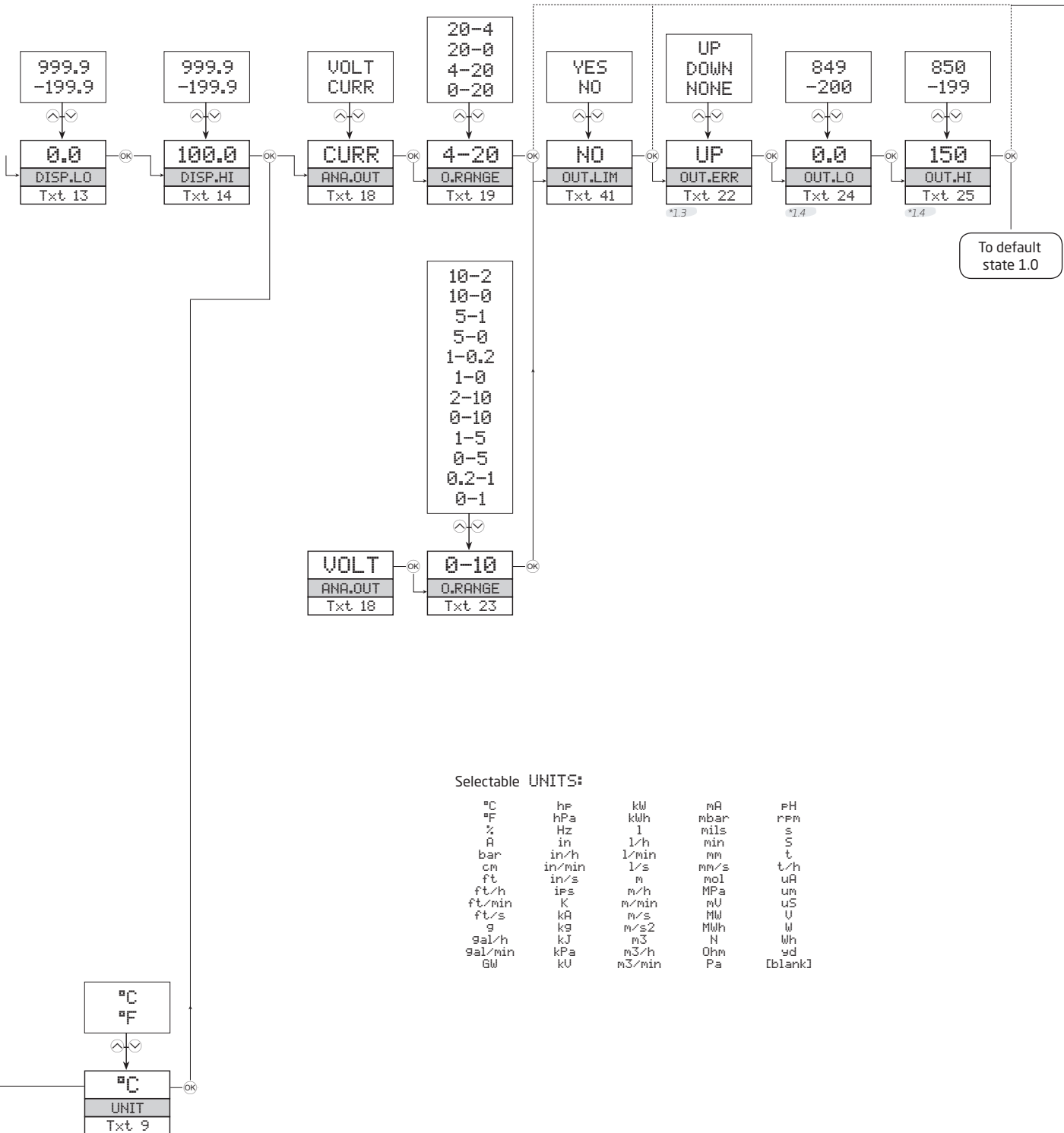

Help text overview

- [01] Set correct password
- [02] Enter advanced setup menu?
- [03] Select temperature input
 - Select potentiometer input
 - Select linear resistance input
 - Select current input
 - Select voltage input
- [04] Select 0.0-1 V input range
 - Select 0.2-1 V input range
 - Select 0-5 V input range
 - Select 1-5 V input range
 - Select 0-10 V input range
 - Select 2-10 V input range
- [05] Select 0-20 mA input range
 - Select 4-20 mA input range
- [06] Select 2-wire sensor connection
 - Select 3-wire sensor connection
 - Select 4-wire sensor connection
- [07] Set resistance value low
- [08] Set resistance value high
- [09] Select Celsius as temperature unit
 - Select Fahrenheit as temperature unit
- [10] Select TC sensor type
 - Select Ni sensor type
 - Select Pt sensor type
- [11] Select display unit
- [12] Select decimal point position
- [13] Set display range low
- [14] Set display range high
- [15] Select Pt10 as sensor type
 - Select Pt20 as sensor type
 - Select Pt50 as sensor type
 - Select Pt100 as sensor type
 - Select Pt200 as sensor type
 - Select Pt250 as sensor type
 - Select Pt300 as sensor type
 - Select Pt400 as sensor type
 - Select Pt500 as sensor type
 - Select Pt1000 as sensor type
- [16] Select Ni50 as sensor type
 - Select Ni100 as sensor type
 - Select Ni120 as sensor type
 - Select Ni1000 as sensor type
- [17] Select TC-B as sensor type
 - Select TC-E as sensor type
 - Select TC-J as sensor type
 - Select TC-K as sensor type
 - Select TC-L as sensor type
 - Select TC-N as sensor type
 - Select TC-R as sensor type
 - Select TC-S as sensor type
 - Select TC-T as sensor type
 - Select TC-U as sensor type
 - Select TC-W3 as sensor type
 - Select TC-W5 as sensor type
 - Select TC-Lr as sensor type
- [18] Select current as analogue output type
 - Select voltage as analogue output type
- [19] Select 0-20 mA output range
 - Select 4-20 mA output range
 - Select 20-0 mA output range
 - Select 20-4 mA output range
- [22] Select no error action - output undefined at error
 - Select downscale at error
 - Select upscale at error
- [23] Select 0.0-1 V output range
 - Select 0.2-1 V output range
 - Select 0-5 V output range
 - Select 1-5 V output range
 - Select 0-10 V output range
 - Select 2-10 V output range
 - Select 1-0.0 V output range
 - Select 1-0.2 V output range
 - Select 5-0 V output range
 - Select 5-1 V output range
 - Select 10-0 V output range
 - Select 10-2 V output range
- [24] Set temperature for analog output low
- [25] Set temperature for analog output high
- [26] Enter language setup
 - Enter password setup
 - Enter simulation mode
 - Perform process calibration
 - Enter display setup
 - Perform memory operations
- [27] Load saved configuration into device
 - Save configuration in display front
- [28] Adjust LCD contrast
- [29] Adjust LCD backlight
- [30] Write a 6-character device TAG
- [31] Analog output value is shown in display line 3
 - Device TAG is shown in display line 3
- [32] Calibrate input low to process value?
- [33] Calibrate input high to process value?
- [34] Set the input simulation value
- [35] Enable password protection?
- [36] Set new password
- [37] Select language
- [38] Use process calibration values?
- [39] Set value for low calibration point
- [40] Set value for high calibration point
- [41] Limit output values to output range)
- [42] Programming mode only - no output signal



JUMO GmbH & Co. KG

Street address:

Moritz-Juchheim-Straße 1
36039 Fulda, Germany

Delivery address:

Mackenrodtstraße 14
36039 Fulda, Germany

Postal address:

36035 Fulda, Germany
Phone: +49 661 6003-0
Fax: +49 661 6003-607
Email: mail@jumo.net
Internet: www.jumo.net

JUMO Instrument Co. Ltd.

JUMO House

Temple Bank, Riverway
Harlow, Essex, CM20 2DY, UK

Phone: +44 1279 63 55 33

Fax: +44 1279 62 50 29

Email: sales@jumo.co.uk

Internet: www.jumo.co.uk

JUMO Process Control, Inc.

6733 Myers Road
East Syracuse, NY 13057, USA

Phone: +1 315 437 5866

Fax: +1 315 437 5860

Email: info.us@jumo.net

Internet: www.jumousa.com

