

JUMO GmbH & Co. KG
 Delivery address: Mackenrodtstraße 14
 36039 Fulda, Germany
 Postal address: 36035 Fulda, Germany
 Phone: +49 661 6003-0
 Fax: +49 661 6003-607
 Email: mail@jumo.net
 Internet: www.jumo.net

JUMO UK LTD
 JUMO House
 Temple Bank, Riverway
 Harlow, Essex, CM20 2DY, UK
 Phone: +44 1279 63 55 33
 Fax: +44 1279 62 50 29
 Email: sales@jumo.co.uk
 Internet: www.jumo.co.uk

JUMO Process Control, Inc.
 6724 Joy Road
 East Syracuse, NY 13057, USA
 Phone: +1 315 437 5866
 Fax: +1 315 437 5860
 Email: info.us@jumo.net
 Internet: www.jumousa.com



JUMO LOGOSCREEN 700

Highly-scalable paperless recorder

Brief description

The JUMO LOGOSCREEN 700 paperless recorder is characterized by an intuitive, icon-based operation and visualization concept that makes it easy to operate.

Multiple versions of the JUMO LOGOSCREEN 700 are available for process data recording. The high level of scalability allows for flexible adaptation to various customer requirements: from the device version without measurement input (120 process values via interface) through to different device versions with up to 18 measurement inputs (universal analog inputs), 3 analog outputs, 18 digital inputs, 24 individually switchable digital inputs/outputs, and 7 relay outputs. The version with FDA-compliant data recording fulfills all requirements according to 21 CFR Part 11.

In order to display the recorded data, the JUMO LOGOSCREEN 700 features various visualizations. In addition, the user can use the setup program to create up to 10 separate process screens – with up to 100 objects per process screen – according to his individual requirements. For batch-based processes, there are up to 5 special batch recordings available, which enable the storage of additional, batch-related information. The extra code, "structured text" allows for the creation of individual measurement and recording applications.



Type 706530/...

Block diagram

Inputs/outputs

Options 1, 2, and 3:
 - 3 analog inputs, 6 digital inputs,
 1 analog output or
 - 3 analog inp. (HI), 4 digital inputs,
 4 digital inputs/outputs
 (2 inputs up to 12.5 kHz) or
 - 6 analog inputs
 each
Option 4:
 - 12 digital inputs/outputs
 (2 inputs up to 12.5 kHz) or
 - 6 relay outputs (changeover)

Inputs via interface

As standard:
 120 external analog inputs and
 120 external digital inputs and
 74 external texts (64 batch texts,
 10 event texts)

Relay output

As standard:
 1 relay (changeover contact)

Display/operation

Display
 14.5 cm (5.7") TFT color screen
 640 x 480 pixel,
 65536 colors

Operation
 Touchscreen (resistive)



Voltage supply

AC 110 to 240 V +10/-15 %, 48 to 63 Hz
 AC/DC 20 to 30 V, 48 to 63 Hz

Interfaces

As standard:
 1x Ethernet 10/100 MBit/s
 1x USB host (flash drive)
 1x USB device (setup)
 1x RS232/RS485
 (Modbus master/slave or
 Barcode scanner)
 Optional:
 1x PROFINET IO Device

Measur.-data memory

Internal memory: 1 GByte
 (data transfer via interface
 or USB flash drive)

Internal channels

20 math channels (optional)
 20 logic channels (optional)
 30 counters/integrators
 8 high-speed counters
 ST code (optional)

Software

Setup program
 PCC, PCA3000
 PCS, PCAT

Special features

- Intuitive touch operation
- Up to 3 analog outputs
- Up to 10 customer-specific process screens
- PROFINET IO device interface (extra code)
- Integrated web server for online visualization as on device
- Recording of up to 5 batch reports
- Up to 500 individual texts
- Limit value monitoring function (120 channels)
- Flow measurement (up to 8 channels)
- Up to 8 counter inputs (max. 12.5 kHz)
- User-specific application using structured text (ST code; extra code)
- Automatic data readout via PCA Communication Software PCC
- Data recording compliant with FDA 21 CFR Part 11 (extra code)
- Manipulation detection with digital certificate (extra code)
- PC programs for data evaluation and access control
- AMS2750/CQI-9 (extra code)
- TUS/SAT field test device (extra code)

Approvals and approval marks (see technical data)



JUMO GmbH & Co. KG
 Delivery address: Mackenrodtstraße 14
 36039 Fulda, Germany
 Postal address: 36035 Fulda, Germany
 Phone: +49 661 6003-0
 Fax: +49 661 6003-607
 Email: mail@jumo.net
 Internet: www.jumo.net

JUMO UK LTD
 JUMO House
 Temple Bank, Riverway
 Harlow, Essex, CM20 2DY, UK
 Phone: +44 1279 63 55 33
 Fax: +44 1279 62 50 29
 Email: sales@jumo.co.uk
 Internet: www.jumo.co.uk

JUMO Process Control, Inc.
 6724 Joy Road
 East Syracuse, NY 13057, USA
 Phone: +1 315 437 5866
 Fax: +1 315 437 5860
 Email: info.us@jumo.net
 Internet: www.jumousa.com



Description

Configuration and operation

On the device

The JUMO operation and visualization concept, allows the user to operate the paperless recorder almost intuitively. All operations are performed with an icon-based menu system on the resistive touchscreen.

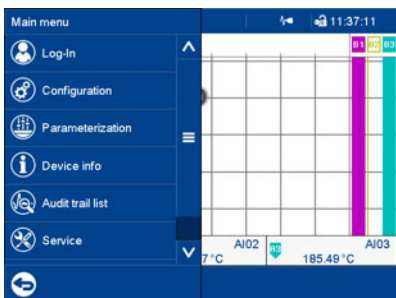

The integrated user management protects the paperless recorder against unauthorized access. The standard version supports up to 5 users with varying access rights. The extra code 888 (FDA 21 CFR Part 11) allows for up to 50 users to be managed.

With the setup program

The paperless recorder can also be configured using the setup program; it should be noted that some functions are only available in the setup program, such as:

- Editing the operating language
- Assigning user rights
- Creating process screens
- Creating texts (e.g. for batch reports and process screens)

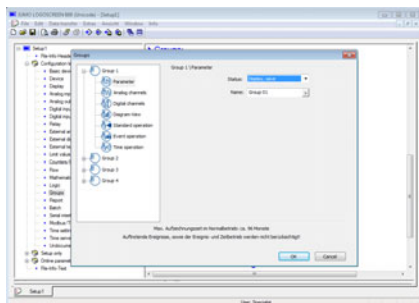

The setup program is installed on a PC with a Windows¹ operating system (7/8/10 – 32 or 64 bit) and communicates with the paperless recorder via USB or Ethernet interface. It is also possible to transfer configuration files to the paperless recorder using a USB flash drive.

¹ Windows is a registered trademark of the Microsoft Corporation.

The user can save the configuration data as a file, which can also be printed out for documentation purposes.

Operating language

Multiple operating languages can be selected on the device. These can be edited and switched using the setup program. The languages German, English, French, Spanish, Czech, Chinese, Russian, and Italian are currently available. Users can also create their own language versions (Unicode compatible).

Process screen editor

The user can use the setup program to create 10 individual process screens which he can subsequently transfer to the paperless recorder and use to display process data and input text and process values there. Each process screen can consist of up to 100 objects (images, analog channels, digital channels, text, etc.).

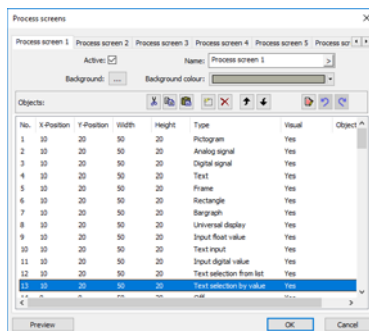

Interfaces

USB

The paperless recorder is equipped with two USB interfaces as a standard feature. A USB flash drive can be connected to the host interface located on the front. The device interface on the back (Micro-B type) can be used to connect the device to a PC (setup program or PCC/PCA3000).

The USB host interface has a cover so that the front of the device complies with protection type IP66.

Ethernet

The paperless recorder is equipped with an Ethernet interface as a standard feature, which supports the following functions:

- Communication with a PC (setup program, web server, data archiving with PCC/PCA3000)
- Email dispatch via SMTP server
- Time synchronization via SNTP server
- Communication with a Modbus master/slave

The IP address is either configured as a fixed address or received automatically from a DHCP server; DNS is supported.

RS232/RS485

This interface available as a standard feature can be configured as RS232 and RS485. It is used for communicating with a Modbus master or a Modbus slave. It can also be used to connect to a barcode scanner.

PROFINET IO device

The paperless recorder can also be equipped with a PROFINET interface and integrated into a PROFINET network as an IO device as an optional extra. The interface also supports simultaneous use of Ethernet standard services; thus Ethernet interfaces as a standard feature are omitted.

A GSD file (GSDML) is available for the programming system of the IO controller, which describes the features of the paperless recorder.

External inputs via interface

The paperless recorder can access 120 external analog inputs and 120 external digital inputs via the interfaces (Ethernet, RS232/RS485). In addition, 64 texts for batch reports and 10 event texts with a text length of up to 160 characters can be transferred. In doing so the Modbus-TCP/Modbus-RTU (master/slave respectively) reports are used.

These external inputs are also available via the optional PROFINET interface.

Inputs and outputs

The different device versions of the paperless recorder are available with analog and digital inputs and outputs (options).

The analog inputs (max. 18) are universal measurement inputs for RTD temperature probes, thermocouples, resistance transmitters, resistance/potentiometers, and standard signals (current, voltage).

The analog outputs (max. 3) can each be used as voltage output (0 to 10 V) or current output (0/4 to 20 mA).

The digital inputs (max. 18) and the individually switchable digital inputs/outputs (max. 24) are operated with a voltage of DC 0/24 V.

All device versions feature a relay output (changeover contact). There is also the option of 6 additional relay outputs (changeover contacts) available.

JUMO GmbH & Co. KG

Delivery address: Mackenrodtstraße 14
36039 Fulda, Germany
Postal address: 36035 Fulda, Germany
Phone: +49 661 6003-0
Fax: +49 661 6003-607
Email: mail@jumo.net
Internet: www.jumo.net

JUMO UK LTD

JUMO House
Temple Bank, Riverway
Harlow, Essex, CM20 2DY, UK
Phone: +44 1279 63 55 33
Fax: +44 1279 62 50 29
Email: sales@jumo.co.uk
Internet: www.jumo.co.uk

JUMO Process Control, Inc.

6724 Joy Road
East Syracuse, NY 13057, USA
Phone: +1 315 437 5866
Fax: +1 315 437 5860
Email: info.us@jumo.net
Internet: www.jumousa.com

**Customer-specific linearization**

Sensor signals with special characteristic line characteristics can also be used through customer-specific linearization (e.g. PTC/NTC sensors under consideration of the resistance measuring range). Configuration is carried out in the setup program on the basis of a value table with up to 40 value pairs or through a formula (4th order polynomial).

Data recording

The measured values are recorded continuously with a sampling rate of 125 ms. Report creation and limit value monitoring are performed based on these measured values. The measured values are transferred to the working memory of the device depending on the programmable memory cycle and memory value (current value, average value, maximum value, minimum value, or minimum/maximum values). The paperless recorder stores the data according to group; one input can be assigned to multiple groups (max. 10). A total of 60 analog channels and 60 digital channels can be recorded; these can be assigned to groups individually (max. 6 analog channels and 6 digital channels per group). Up to four groups can be recorded at the same time with the fastest memory cycle of 125 ms.

Working memory (SRAM)

The data stored in the SRAM is copied to the internal memory in 20-kByte blocks at regular intervals.

Internal memory (flash)

Whenever a memory block in the working memory is full, it is copied to the internal memory. The internal memory has a maximum capacity of 1 GB. Each write operation is monitored to ensure that any data storage errors are detected immediately.

The device monitors the capacity of the internal memory and, if the remaining capacity falls below the configured minimum, a memory alarm signal is triggered. This can, for example, control the alarm relay.

The data is written to the memory as a ring buffer, which means that when the memory is full, the oldest data is automatically overwritten with new data.

To show the history in the paperless recorder, data from the internal memory can be displayed (history memory: 8 MByte).

Data transfer to PC

Data can be transferred from the paperless recorder to a PC via a USB flash drive or via one of the interfaces (USB device, Ethernet).

Data security

Data is stored in an encrypted format developed by JUMO. This ensures a high level of data security.

The following applies if the paperless recorder is disconnected from the voltage supply:

- Measurement data in the working memory and time are buffered by a lithium battery (operating life > 7 years).
- If the lithium battery is discharged, the measurement data in the working memory and the time are lost. For the purposes of a battery change, the data is buffered for approximately 2 minutes by a storage capacitor.
- Measurement and configuration data in the internal memory are not lost.

Extra code 887 gives the device reliable manipulation detection. A digital device certificate verifies that the recording data in the device has not been manipulated – which also applies to the transfer into the data archive.

Recording time

The maximum recording time depends on a number of factors, in particular on the set memory cycle. The values specified in the table (entries in the event list reduce the maximum recording time) apply when a group with 6 analog channels is activated in standard operation and storage of average values (not the minimum/maximum values).

Memory cycle	Max. recording time
125 ms	Approx. 42 days
1 s	Approx. 8 months
5 s	Approx. 41 months
10 s	Approx. 82 months
60 s	Approx. 493 months

Reports

For each channel in a group, reports can be maintained over specified time periods (maximum, minimum, and average values). Configuration takes place for each group.

Batch report

The paperless recorder allows batch reports to be created for up to 5 plants. The measurement data, the beginning, end, and duration of the batch can be displayed together with a batch counter and freely definable texts on the paperless recorder and in the PC Evaluation Software PCA3000. A barcode scanner can also be used to start and stop the batch and to load batch texts.

GPS data recording

GPS data (NMEA 0183 data records) can be received and recorded via the serial interface of the device. The data of the connected GPS receivers (e.g. positioning data) are cyclically entered into the event list (group-related) and can thus be evaluated in conjunction with further registration data.

Operating modes

The operating mode can be selected individually for each group. The memory cycle and memory value can be separately configured for each operating mode. Up to 4 groups can be recorded with one memory cycle of 125 ms.

The operating modes have different priorities:

Event operation

Event operation is activated/deactivated by a control signal (such as a digital input, group, or collective alarm). The device is in event operation for as long as the control signal is active. Event operation has the highest priority.

Time operation

Time operation is active on a daily basis within a programmable timeframe, providing event operation is not active.

Standard operation

If the device is **not** in event or time operation, standard operation is active.

Limit value monitoring function

Up to 120 analog values can be monitored by the configurable limit value monitoring function. In the event of deviation above or below the limit value, an alarm signal is generated that can be used for individual purposes (such as switching the operating mode from standard to event operation).

The alarm delay can be used to hide short-term deviations above or below the limit value so that no alarm signal is issued. It is also possible to suppress the alarm signal by a digital signal.

Limit value and switching differential can also be changed as part of parameterization, provided the user has the rights to do this.

Counters/integrators

Thirty additional internal channels are available as counters, integrators, operating time counters, or to determine the total flow volume. Up to 8 high-speed counters can be implemented (up to 12.5 kHz) using specific optional extra digital inputs/outputs or digital

JUMO GmbH & Co. KG
 Delivery address: Mackenrodtstraße 14
 36039 Fulda, Germany
 Postal address: 36035 Fulda, Germany
 Phone: +49 661 6003-0
 Fax: +49 661 6003-607
 Email: mail@jumo.net
 Internet: www.jumo.net

JUMO UK LTD
 JUMO House
 Temple Bank, Riverway
 Harlow, Essex, CM20 2DY, UK
 Phone: +44 1279 63 55 33
 Fax: +44 1279 62 50 29
 Email: sales@jumo.co.uk
 Internet: www.jumo.co.uk

JUMO Process Control, Inc.
 6724 Joy Road
 East Syracuse, NY 13057, USA
 Phone: +1 315 437 5866
 Fax: +1 315 437 5860
 Email: info.us@jumo.net
 Internet: www.jumousa.com



inputs. These optional extra inputs are also required for flow measurement, if the pulses of a flow transmitter are to be evaluated.

The counters are controlled via digital signals (counting pulses), whereas the integrators are controlled via analog signals (value integrated according to the selected time base). Operating time counters determine the timeframe during which a digital signal is active.

The value of the counter/integrator is displayed in a separate window of the paperless recorder in numerical format with a maximum of 9 digits (in the event that this is exceeded, the counter restarts with 0). Different recording periods can be set. A minimum and maximum alarm can be configured for each counter/integrator.

Up to 6 counters can be assigned to one group.

Math and logic module

The math and logic module (each with 20 channels) is available as extra code.

The math function can be used to link various analog and Boolean input variables using a formula which can be defined freely in accordance with mathematical rules (formula with a maximum of 160 ASCII characters). The output variables are real values. As an alternative to entering a formula, the following mathematical functions are already available: difference, ratio, humidity, and floating average.

The logic function allows various Boolean values to be linked using a logic formula (maximum of 600 ASCII characters). The output variables are Boolean values.

The math and logic module can only be configured via the setup program.

Structured text

The user has the option to create his/her own application using the "Structured text" option (extra code).

The application with the ST editor, which is part of the setup program, is created in the PLC programming language "Structured text". The finished application is transmitted to the device and continuously processed there. There are online-debugger functions available in the ST editor for testing and troubleshooting.

FDA-compliant data recording

Extra code 888 allows the paperless recorder to fully meet FDA requirements in accordance with 21 CFR Part 11. User management and startup require the PC software package (including PCS and PCAT).

The device supports up to 50 users with specific rights. The user has the option to provide a completed batch or the recording data of a certain time range with their electronic signature. A logged-in user can also provide their signature during logoff – it applies to the entire time period for which the user was logged in.

Visualization on the device

Various display types are available to visualize the measurement data on the paperless recorder. The visualization screen after power-on-reset can be selected in the configuration, as can the screen that appears when the home button is pressed.

The colors of the individual channels and the background color of the analog curves and the digital traces can be set.

Vertical diagram

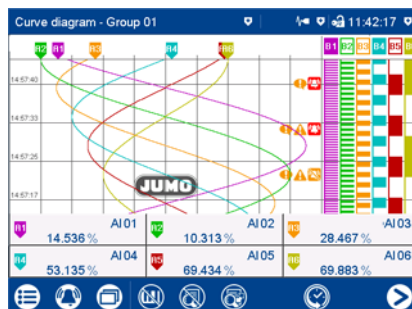

- Analog curves and digital traces running from top to bottom
- Up to 6 analog and 6 digital channels in one group can be shown on one screen
- Group rotation (max. 10, of which 4 with maximum memory cycle)
- Digital traces can be hidden
- Channel information (short description of signal, analog value) can be hidden
- Auxiliary lines can be shown and hidden

Horizontal diagram

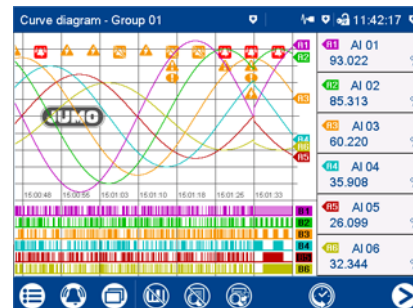

- Analog curves and digital traces running from right to left
- Digital traces and channel information can be hidden
- Auxiliary lines can be shown and hidden

Digital diagram

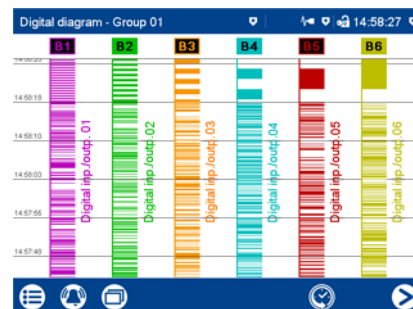

- Up to 6 digital channels in one group on one screen
- Vertical display (digital traces running from top to bottom)
- Horizontal display (digital traces running from right to left)

Bar graph display

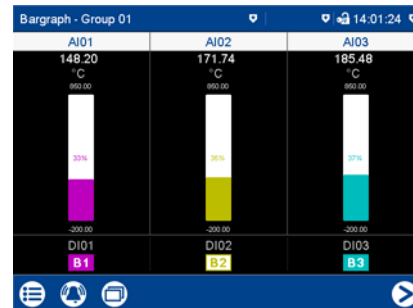

- Up to 6 analog channels in one group as a bar graph on one screen
- Display of scaling and limit values
- Configurable bar color and background color
- Additional display of up to 6 digital channels in one group as a symbol B1 to B6

JUMO GmbH & Co. KG
 Delivery address: Mackenrodtstraße 14
 36039 Fulda, Germany
 Postal address: 36035 Fulda, Germany
 Phone: +49 661 6003-0
 Fax: +49 661 6003-607
 Email: mail@jumo.net
 Internet: www.jumo.net

JUMO UK LTD
 JUMO House
 Temple Bank, Riverway
 Harlow, Essex, CM20 2DY, UK
 Phone: +44 1279 63 55 33
 Fax: +44 1279 62 50 29
 Email: sales@jumo.co.uk
 Internet: www.jumo.co.uk

JUMO Process Control, Inc.
 6724 Joy Road
 East Syracuse, NY 13057, USA
 Phone: +1 315 437 5866
 Fax: +1 315 437 5860
 Email: info.us@jumo.net
 Internet: www.jumousa.com



Text image

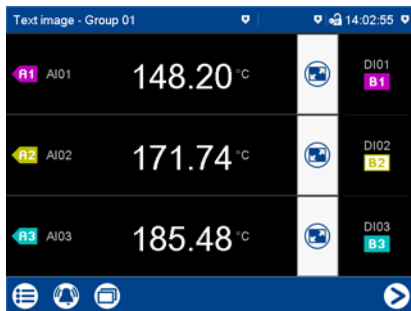

- Numerical display of the measured values from up to 6 analog channels in one group
- Additional display of up to 6 digital channels in one group as a symbol B1 to B6
- Analog channels can be displayed individually

Text image – individual display

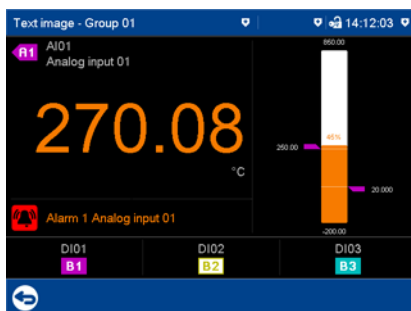

- Analog signal also as bar graph with limit values
- Color change in case of an alarm
- Alarm text display

Report

	Current °C	Completed °C
Maximum value	216.44	209.71
Time	08/19/2015 14:21:43	08/19/2015 14:21:34
Minimum value	176.60	51.169
Time	08/19/2015 14:21:50	08/19/2015 14:21:19
Average value	189.64	93.478
Timestamp start	08/19/2015 14:21:38	08/19/2015 14:21:09
Timestamp end	08/19/2015 14:21:51	08/19/2015 14:21:36

- Display of minimum, maximum, and average value of each analog channel in a group
- Various reporting periods
- Separate report for each group
- Display of current and completed reports

Batch report

Actual batch - Furnace 14.1	
Product name	Sprocket 18SP2
Customer no.	23565
Order no.	O100012455
Employee	John Miller
Batch number	0000000024
Batch start	08/19/2015 15:01:56
Batch end	08/19/2015 15:02:59
Batch duration	01:04

- Logging of a batch recording
- Display of the completed batch as a report or curve diagram
- Up to 5 batch recordings simultaneously

Batch-related alarm and event list

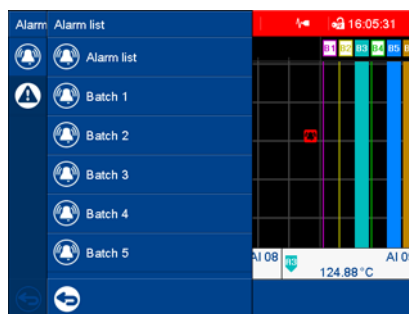

- Separate alarm list and event list for each active batch
- Batch-related entries due to group assignment
- Events and alarms of channels and counters/integrators

Counter/integrator

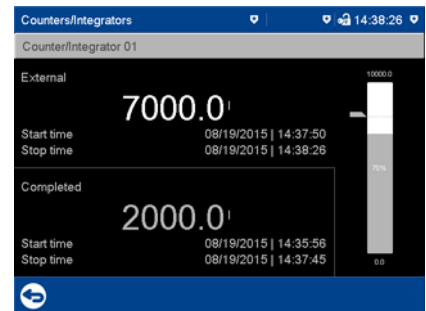

- Display of the current and the completed counter/integrator
- Status of the counter/integrator with start and stop time
- Bar graph display of the current status with limit values
- Up to 30 counters/integrators simultaneously
- Display of last 7 completed counters/integrators

Process screen

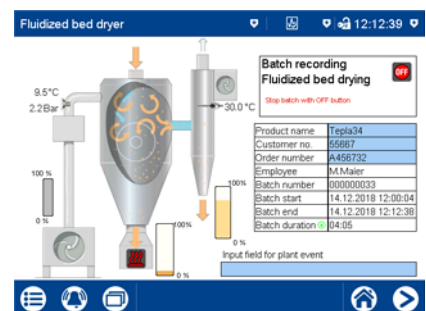

- Display of process data (analog and digital signals) and texts as well as text and value entry
- Up to 10 process screens each with 100 objects
- Library with pictograms (also possible to import own images)
- Individual configuration using the setup program

Web server

The paperless recorder is equipped with a web server function as a standard feature.



JUMO GmbH & Co. KG
 Delivery address: Mackenrodtstraße 14
 36039 Fulda, Germany
 Postal address: 36035 Fulda, Germany
 Phone: +49 661 6003-0
 Fax: +49 661 6003-607
 Email: mail@jumo.net
 Internet: www.jumo.net

JUMO UK LTD
 JUMO House
 Temple Bank, Riverway
 Harlow, Essex, CM20 2DY, UK
 Phone: +44 1279 63 55 33
 Fax: +44 1279 62 50 29
 Email: sales@jumo.co.uk
 Internet: www.jumo.co.uk

JUMO Process Control, Inc.
 6724 Joy Road
 East Syracuse, NY 13057, USA
 Phone: +1 315 437 5866
 Fax: +1 315 437 5860
 Email: info.us@jumo.net
 Internet: www.jumousa.com



The web server allows the user to display certain settings, process values, and messages using a web browser:

- Parameters of the user level
- Default visualizations
- Individual process screen
- Data of the recording function (including history)
- Alarm and event list

The display depends on the web browser used and the PC operating system.

PC programs

With basic type extension 1, the paperless recorder will come with a software package consisting of the following PC programs: setup, PCC, and PCA3000. With extra code 888 the software package also includes the PC programs PCS and PCAT (see order details).

PCA communication software PCC

The PCA Communication Software PCC is a PC program for Windows operating systems (7/8/10 – 32/64 bit) for extracting data from the paperless recorder.

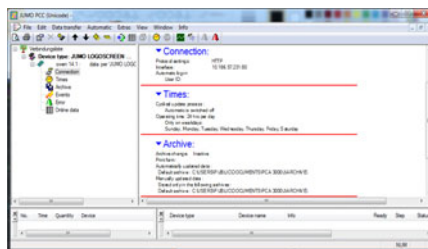

- The data can be extracted with a USB flash drive or via an interface (USB device, Ethernet).
- The data can be extracted manually or automatically (for example, every day at 11 pm).

PC Evaluation Software PCA3000

The PC Evaluation Software PCA3000 is a PC program for Windows operating systems (7/8/10 – 32/64 bit) for managing, archiving, visualizing, and evaluating the data from the paperless recorder.

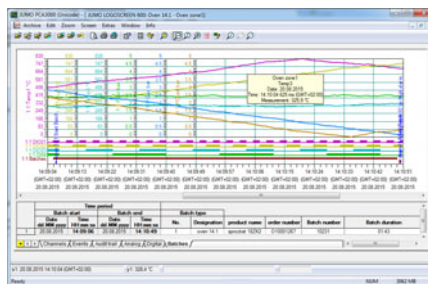

- The data from differently configured devices is detected by the PC Evaluation Software and stored in an archive database. Management is performed fully au-

tomatically. All the user has to do is manually enter an ID (additional description).

- The user can access certain data records which are recognizable due to the ID, at any time. The time ranges to be evaluated can also be restricted.
- Any analog and digital channels of a paperless recorder (even from different groups) can be subsequently combined in so-called PCA groups in PCA3000.
- Since each group is shown in its own window, several groups can be displayed on the screen in parallel and compared.
- Using the export filter, it is possible to export the stored data in order to process it in other programs, such as Excel.
- The PC Evaluation Software PCA3000 is network compatible, which means that several users can read the data from the same archived file (*.177) in a network directory independently of one another.
- Batch data or even reports can be automatically printed or made available in the network as PDF files, using the "automatic printout" PCA3000 option in conjunction with the PCC software. The output forms used can be customized.

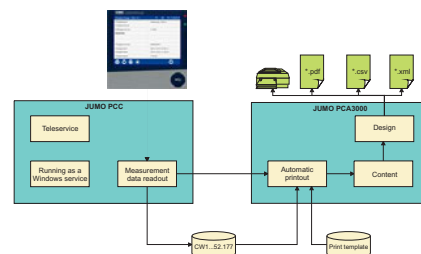

PC Security Manager PCS

Software for administration of device user access control. This software is only accessible to administrators.

The PCS software can only be used for devices with extra code 888, for managing device users.

PC Audit Trail Manager PCAT

Software for the documentation of PC operational actions that could lead to alterations in data recording.

JUMO GmbH & Co. KG
 Delivery address: Mackenrodtstraße 14
 36039 Fulda, Germany
 Postal address: 36035 Fulda, Germany
 Phone: +49 661 6003-0
 Fax: +49 661 6003-607
 Email: mail@jumo.net
 Internet: www.jumo.net

JUMO UK LTD
 JUMO House
 Temple Bank, Riverway
 Harlow, Essex, CM20 2DY, UK
 Phone: +44 1279 63 55 33
 Fax: +44 1279 62 50 29
 Email: sales@jumo.co.uk
 Internet: www.jumo.co.uk

JUMO Process Control, Inc.
 6724 Joy Road
 East Syracuse, NY 13057, USA
 Phone: +1 315 437 5866
 Fax: +1 315 437 5860
 Email: info.us@jumo.net
 Internet: www.jumousa.com



Technical data

Analog inputs

General

Number	Max. 18 (see connection diagram)
A/D converter	24 bit delta-sigma
Sampling rate	Up to 18 channels: 125 ms
Input filter	Digital filter, 2nd order; filter constant can be set from 0 to 100.0 s
Galvanic isolation	See "Galvanic isolation"

Thermocouples

Designation	Type	Standard	ITS	Measuring range	Accuracy ^a
Fe-CuNi	"L"	DIN 43710 (1985)	IPTS-68	-200 to +900 °C	≤ 0.1 %
Fe-CuNi	"J"	DIN EN 60584-1:2014 IEC 60584-1:2013	ITS-90	-210 to +1200 °C	≤ 0.1 % from -100 °C
Cu-CuNi	"U"	DIN 43710 (1985)	IPTS-68	-200 to +600 °C	≤ 0.1 % from -100 °C
Cu-CuNi	"T"	DIN EN 60584-1:2014 IEC 60584-1:2013	ITS-90	-270 to +400 °C	≤ 0.1 % from -150 °C
NiCr-Ni	"K"	DIN EN 60584-1:2014 IEC 60584-1:2013	ITS-90	-270 to +1300 °C	≤ 0.1 % from -80 °C
NiCr-CuNi	"E"	DIN EN 60584-1:2014 IEC 60584-1:2013	ITS-90	-270 to +1000 °C	≤ 0.1 % from -80 °C
NiCrSi-NiSi	"N"	DIN EN 60584-1:2014 IEC 60584-1:2013	ITS-90	-270 to +1300 °C	≤ 0.1 % from -80 °C
Pt10Rh-Pt	"S"	DIN EN 60584-1:2014 IEC 60584-1:2013	ITS-90	-50 to +1768 °C	≤ 0.15 % from 100 °C
Pt13Rh-Pt	"R"	DIN EN 60584-1:2014 IEC 60584-1:2013	ITS-90	-50 to +1768 °C	≤ 0.15 % from 100 °C
Pt30Rh-Pt6Rh	"B"	DIN EN 60584-1:2014 IEC 60584-1:2013	ITS-90	0 to 1820 °C	≤ 0.15 % from 600 °C
W5Re-W26Re	"C"	DIN EN 60584-1:2014 IEC 60584-1:2013	ITS-90	0 to 2315 °C	≤ 0.1 % from 500 °C
W3Re-W25Re	"D"	ASTM E1751M-15	ITS-90	0 to 2315 °C	≤ 0.1 % from 500 °C
W5Re-W20Re	"A1"	GOST R 8.585-2001	ITS-90	0 to 2500 °C	≤ 0.1 % from 500 °C
Chromel®-Copel	"L"	GOST R 8.585-2001	ITS-90	-200 to +800 °C	≤ 0.1 % from -80 °C
Chromel®-Alumel®	"K"	GOST R 8.585-2001	ITS-90	-270 to +1372 °C	≤ 0.1 % from -80 °C
PLII (Platinel® II)		ASTM E1751M-15	ITS-90	0 to 1395 °C	≤ 0.1 %

^a Accuracy refers to the measuring range.

Ambient temperature influence	≤ 100 ppm/K
Cold junction	Internal (Pt100) or external (constant) or external terminal with integrated cold junction (accessories)
Cold junction accuracy (internal Pt100)	Option with 3 analog inputs (order codes 1 and 2): ± 1 K Option with 6 analog inputs (order code 3): ± 2 K
Cold junction temperature (external constant)	-30 to +85 °C (adjustable)
Cold junction accuracy of the external terminal (TC terminal, accessories) ^a	Typically ± 0.4 K at ambient temperature 23 °C ± 0.5 K at ambient temperature 0 to 40 °C
Base measuring range	-20 to +70 mV

^a The accuracy applies to the measuring range from -100 °C.

JUMO GmbH & Co. KG
 Delivery address: Mackenrodtstraße 14
 36039 Fulda, Germany
 Postal address: 36035 Fulda, Germany
 Phone: +49 661 6003-0
 Fax: +49 661 6003-607
 Email: mail@jumo.net
 Internet: www.jumo.net

JUMO UK LTD
 JUMO House
 Temple Bank, Riverway
 Harlow, Essex, CM20 2DY, UK
 Phone: +44 1279 63 55 33
 Fax: +44 1279 62 50 29
 Email: sales@jumo.co.uk
 Internet: www.jumo.co.uk

JUMO Process Control, Inc.
 6724 Joy Road
 East Syracuse, NY 13057, USA
 Phone: +1 315 437 5866
 Fax: +1 315 437 5860
 Email: info.us@jumo.net
 Internet: www.jumousa.com



Thermocouple accuracy as TUS/SAT field test device (extra code 949)

By using the TC terminal (30053080), the device meets the accuracy requirements of $\pm 0.6\text{ °C}$ according to AMS2750G (6-1-5; 3.2.1.3 Calibration Accuracy) and CQI-9 (6-2-1; 3.2.1.3 Calibration Accuracy) and can therefore be used as a mobile TUS/SAT data recorder.

For this purpose, an overall system calibration including adjustment of the individual analog channels is performed at the factory in the certified DAkkS laboratory.

The following measurement accuracy results after the overall system calibration:

Designation	Type	Measuring range	Measurement accuracy	
			typical ^a	guaranteed ^b
Fe-CuNi	J	100 to 1200 °C	$\pm 0.3\text{ °C}$	$\pm 0.6\text{ °C}$
NiCr-Ni	K	100 to 1300 °C	$\pm 0.3\text{ °C}$	$\pm 0.6\text{ °C}$
NiCrSi-NiSi	N	100 to 1300 °C	$\pm 0.3\text{ °C}$	$\pm 0.6\text{ °C}$
Pt10Rh-Pt	S	600 to 1768 °C	$\pm 0.5\text{ °C}$	$\pm 0.6\text{ °C}$
Pt13Rh-Pt	R	600 to 1768 °C	$\pm 0.5\text{ °C}$	$\pm 0.6\text{ °C}$

^a typical measurement accuracy under standard operating conditions $23\text{ °C} \pm 5\text{ °C}$ (incl. cold junction accuracy)

^b quaranteed measurement accuracy after overall system calibration (incl. cold junction accuracy)

According to AMS2750 and CQI-9, recalibration of the TUS/SAT field test device is necessary after 12 months at the latest. The operator is responsible for this. The manufacturer offers recalibration of the device as a service.

RTD temperature probe

Designation	Standard	ITS	Measuring range	Accuracy ^a	Measuring current
Pt50	DIN EN 60751:2009 IEC 60751:2008	ITS-90	-200 to +850 °C	$\leq 0.1\%$	500 μA
Pt100	DIN EN 60751:2009 IEC 60751:2008	ITS-90	-200 to +850 °C	$\leq 0.1\%$	500 μA
Pt500	DIN EN 60751:2009 IEC 60751:2008	ITS-90	-200 to +850 °C	$\leq 0.1\%$	50 μA
Pt1000	DIN EN 60751:2009 IEC 60751:2008	ITS-90	-200 to +850 °C	$\leq 0.1\%$	50 μA
Pt100	JIS C 1604:1981	IPTS-68	-200 to +649 °C	$\leq 0.1\%$	500 μA
Pt50	GOST 6651-2009 A.2	ITS-90	-200 to +850 °C	$\leq 0.1\%$	500 μA
Pt100	GOST 6651-2009 A.2	ITS-90	-200 to +850 °C	$\leq 0.1\%$	500 μA
Cu50	GOST 6651-2009 A.3	ITS-90	-180 to +200 °C	$\leq 0.4\%$	500 μA
Cu100	GOST 6651-2009 A.3	ITS-90	-180 to +200 °C	$\leq 0.4\%$	500 μA
Ni100	DIN 43760 (1987)	IPTS-68	-60 to +250 °C	$\leq 0.2\%$	500 μA
Ni100	GOST 6651-2009 A.5	ITS-90	-60 to +180 °C	$\leq 0.2\%$	500 μA
Connection type		2/3/4-wire			
Ambient temperature influence		$\leq 50\text{ ppm/K}$			
Sensor line resistance		Max. 10 Ω per cable for two-wire circuit Max. 30 Ω per cable for three/four-wire circuit			

^a Accuracy refers to the measuring range.

JUMO GmbH & Co. KG
 Delivery address: Mackenrodtstraße 14
 36039 Fulda, Germany
 Postal address: 36035 Fulda, Germany
 Phone: +49 661 6003-0
 Fax: +49 661 6003-607
 Email: mail@jumo.net
 Internet: www.jumo.net

JUMO UK LTD
 JUMO House
 Temple Bank, Riverway
 Harlow, Essex, CM20 2DY, UK
 Phone: +44 1279 63 55 33
 Fax: +44 1279 62 50 29
 Email: sales@jumo.co.uk
 Internet: www.jumo.co.uk

JUMO Process Control, Inc.
 6724 Joy Road
 East Syracuse, NY 13057, USA
 Phone: +1 315 437 5866
 Fax: +1 315 437 5860
 Email: info.us@jumo.net
 Internet: www.jumousa.com



Resistance transmitter and resistance/potentiometer

Designation	Measuring range	Accuracy ^a	Measuring current
Resistance transmitter	0 to 4000 Ω	≤ 0.1 %	50 μA
Resistance/potentiometer	0 to 400 Ω	≤ 0.1 %	500 μA
	0 to 4000 Ω	≤ 0.1 %	50 μA
Ambient temperature influence	≤ 100 ppm/K		
Connection type			
Resistance transmitter	Three-wire circuit		
Resistance/potentiometer	Two/three/four-wire circuit		
Smallest measuring span	60 Ω		
Sensor line resistance	Max. 10 Ω per cable for two-wire and three-wire circuits		
Resistance values	Freely programmable within the limits, in increments of 0.1 Ω		

^a Accuracy refers to the maximum measuring range. Small measuring spans lead to reduced linearization accuracy.

Voltage, current (standard signals)

Designation	Measuring range	Accuracy ^a	Input resistance or burden voltage
Voltage	0 to 70 mV	≤ 0.1 %	> 500 kΩ
	0 to 10 V	≤ 0.05 %	> 500 kΩ
	-10 to +10 V	≤ 0.05 %	> 500 kΩ
	-1 to +1 V	≤ 0.08 %	> 500 kΩ
	0 to 1 V	≤ 0.08 %	> 500 kΩ
Current	4 to 20 mA	≤ 0.1 %	< 2 V
	0 to 20 mA	≤ 0.1 %	< 2 V
Ambient temperature influence	≤ 100 ppm/K		
Smallest measuring span			
Voltage	5 mV		
Current	0.5 mA		
Measuring range start/end			
Voltage	Freely programmable within the limits, in increments of 0.01 mV		
Current	Freely programmable within the limits, in increments of 0.01 mA		
Deviation below/above the measur. range	According to NAMUR recommendation NE 43 (only current input 4 to 20 mA)		

^a Accuracy refers to the maximum measuring range. Small measuring spans lead to reduced linearization accuracy.

JUMO GmbH & Co. KG
 Delivery address: Mackenrodtstraße 14
 36039 Fulda, Germany
 Postal address: 36035 Fulda, Germany
 Phone: +49 661 6003-0
 Fax: +49 661 6003-607
 Email: mail@jumo.net
 Internet: www.jumo.net

JUMO UK LTD
 JUMO House
 Temple Bank, Riverway
 Harlow, Essex, CM20 2DY, UK
 Phone: +44 1279 63 55 33
 Fax: +44 1279 62 50 29
 Email: sales@jumo.co.uk
 Internet: www.jumo.co.uk

JUMO Process Control, Inc.
 6724 Joy Road
 East Syracuse, NY 13057, USA
 Phone: +1 315 437 5866
 Fax: +1 315 437 5860
 Email: info.us@jumo.net
 Internet: www.jumousa.com



Measuring circuit monitoring

The device behavior in the event of a malfunction is configurable.

Measuring probe	Probe break	Short-circuit	Polarity
Thermocouple	Is detected	Is not detected	Is detected in certain conditions ^a
RTD temperature probe	Is detected	Is detected	Is not detected
Resistance transmitter	Is detected	Is not detected	Is not detected
Resistance/potentiometer	Is detected	Is not detected	Is not detected
Voltage 0 to 70 mV	Is detected	Is not detected	Is detected
Voltage 0 to 10 V	Is not detected	Is not detected	Is detected
Voltage -10 to +10 V	Is not detected	Is not detected	Is not detected
Voltage 0 to 1 V	Is detected	Is not detected	Is detected
Voltage -1 to +1 V	Is detected	Is not detected	Is not detected
Current 0 to 20 mA	Is not detected	Is not detected	Is not detected
Current 4 to 20 mA	Is detected	Is detected	Is detected

^a Dependent on the set characteristic line

Analog outputs

Number	Max. 3 (see connection diagram)
Voltage	
Output signal	DC 0 to 10 V
Load resistance	> 500 Ω
Current	
Output signal	DC 0(4) to 20 mA
Load resistance	< 450 Ω
Accuracy	0.5 %
Ambient temperature influence	150 ppm/K

Digital inputs

Number	Max. 18 (see connection diagram)
Input	
Level	Logic level 0: < 3.5 V; logic level 1: > 10 V
Sampling rate	125 ms (max. counting frequency: 4 Hz)
Potential-free contact	R _{ON} : < 1 kΩ; R _{OFF} : > 50 kΩ (use of auxiliary voltage 24 V)
High-speed input	
Usable inputs	1, 2, 7, 8, 13, 14 (only for analog(HI)/digital option, see connection diagram)
Function	Counts each positive edge of the input signal
Max. counting frequency	12.5 kHz
Mark-to-space ratio	30 to 70 % (high-pulse ≥ 30 μs, low-pulse ≥ 30 μs)
Accuracy for flow measurement	0.5 % of measured value; ambient temperature influence: 50 ppm/K
Auxiliary voltage supply	
Voltage	DC 24 V +10/-15 %
Current	Max. 50 mA per slot (for analog (HI)/digital option: incl. digital output currents)

JUMO GmbH & Co. KG
 Delivery address: Mackenrodtstraße 14
 36039 Fulda, Germany
 Postal address: 36035 Fulda, Germany
 Phone: +49 661 6003-0
 Fax: +49 661 6003-607
 Email: mail@jumo.net
 Internet: www.jumo.net

JUMO UK LTD
 JUMO House
 Temple Bank, Riverway
 Harlow, Essex, CM20 2DY, UK
 Phone: +44 1279 63 55 33
 Fax: +44 1279 62 50 29
 Email: sales@jumo.co.uk
 Internet: www.jumo.co.uk

JUMO Process Control, Inc.
 6724 Joy Road
 East Syracuse, NY 13057, USA
 Phone: +1 315 437 5866
 Fax: +1 315 437 5860
 Email: info.us@jumo.net
 Internet: www.jumousa.com



Digital inputs/outputs

Number	Max. 24 (see connection diagram)
Input or output	Individually configurable as input or output
Input	
Level	Logic level 0: < 3.5 V; logic level 1: > 10 V
Sampling rate	125 ms (max. counting frequency: 4 Hz)
Potential-free contact	R _{ON} : < 1 kΩ; R _{OFF} : > 50 kΩ (use of auxiliary voltage 24 V)
High-speed input	
Usable inputs	1, 2 (see connection diagram)
Function	Counts each positive edge of the input signal
Max. counting frequency	12.5 kHz
Mark-to-space ratio	30 to 70 % (high-pulse ≥ 30 μs, low-pulse ≥ 30 μs)
Accuracy for flow measurement	0.5 % of measured value; ambient temperature influence: 50 ppm/K
Output	
Output signal	DC 0/24 V +10/-15 %; galvanically isolated
Current at option	
- Analog(HI)/digital	Max. 40 mA per output, max. 50 mA in total per slot (including auxiliary voltage supply current)
- Digital	Max. 40 mA per output, max. 100 mA in total (including auxiliary voltage supply current)
Auxiliary voltage supply	
Voltage	DC 24 V +10/-15 %
Current at option	
- Analog(HI)/digital	Max. 50 mA per slot (including digital outputs current)
- Digital	Max. 100 mA (including digital outputs current)

Relays

Number	Max. 7 (see connection diagram)
Relay (changeover contact)	
Switching capacity	3 A at AC 230 V or DC 30 V, resistive load
Contact life	30,000 switching operations at rated load

JUMO GmbH & Co. KG
 Delivery address: Mackenrodtstraße 14
 36039 Fulda, Germany
 Postal address: 36035 Fulda, Germany
 Phone: +49 661 6003-0
 Fax: +49 661 6003-607
 Email: mail@jumo.net
 Internet: www.jumo.net

JUMO UK LTD
 JUMO House
 Temple Bank, Riverway
 Harlow, Essex, CM20 2DY, UK
 Phone: +44 1279 63 55 33
 Fax: +44 1279 62 50 29
 Email: sales@jumo.co.uk
 Internet: www.jumo.co.uk

JUMO Process Control, Inc.
 6724 Joy Road
 East Syracuse, NY 13057, USA
 Phone: +1 315 437 5866
 Fax: +1 315 437 5860
 Email: info.us@jumo.net
 Internet: www.jumousa.com



Interfaces

RS232/RS485 Number Connector type Baud rate Data format Protocol Application External inputs	1 (can be switched between RS232 and RS485) SUB-D 9-pin (socket) 4800, 9600, 19200, 38400, 115200 8/1n, 8/1e, 8/1o Modbus RTU as master or slave, barcode scanner, NMEA 0183 Communication with Modbus master/slave, connection of a barcode scanner or a GPS receiver Via Modbus master/slave functionality: 120 analog and 120 digital inputs, 64 batch texts, 10 event texts
Ethernet Number Connector type Transfer rate Protocol Application External inputs Max. cable length	1 (alternative to PROFINET interface) RJ45 (socket) 10 Mbit/s, 100 Mbit/s IPv4; TCP, UDP; DHCP, DNS, HTTP, SMTP, SNMP, Modbus-TCP Communication with PC (setup program, data archiving, web server), email server, SNMP server, and Modbus master/slave Via Modbus master/slave functionality: 120 analog and 120 digital inputs, 64 batch texts, 10 event texts 100 m
PROFINET IO device Number Connector type Transfer rate Conformity class Netload class Protocol Application Max. cable length	1 (alternative to Ethernet interface) 2 x RJ45 (socket), integrated switch 100 Mbit/s B (CC-B) III (Netload Class III) DCP, LLDP, VLAN Priority, PTCP Communication with PROFINET IO controller; Ethernet standard services are also supported 100 m
USB host Number Connector type Standard Application Max. load current	1 (on front with cover) A (socket) USB 2.0 (high speed) Exclusively for connecting a USB flash drive (FAT16/FAT32; see accessories) 100 mA
USB device Number Connector type Standard Application Max. cable length	1 (on the back) Micro-B (socket) USB 2.0 (high speed) To connect to a PC (setup program, PCC/PCA3000) 5 m

JUMO GmbH & Co. KG
 Delivery address: Mackenrodtstraße 14
 36039 Fulda, Germany
 Postal address: 36035 Fulda, Germany
 Phone: +49 661 6003-0
 Fax: +49 661 6003-607
 Email: mail@jumo.net
 Internet: www.jumo.net

JUMO UK LTD
 JUMO House
 Temple Bank, Riverway
 Harlow, Essex, CM20 2DY, UK
 Phone: +44 1279 63 55 33
 Fax: +44 1279 62 50 29
 Email: sales@jumo.co.uk
 Internet: www.jumo.co.uk

JUMO Process Control, Inc.
 6724 Joy Road
 East Syracuse, NY 13057, USA
 Phone: +1 315 437 5866
 Fax: +1 315 437 5860
 Email: info.us@jumo.net
 Internet: www.jumousa.com



Screen

Type	TFT color screen/TFT-touchscreen (resistive) ^a
Size	14.5 cm (5.7")
Resolution	640 × 480 pixels (VGA)
Number of colors	65536
Frame rate	60 Hz (type)
Brightness setting	Adjustable on the device
Screensaver (switch-off)	After waiting period or due to control signal

^a TFT color screens may have pixel errors due to technological and/or production-related reasons. Up to four pixel errors are deemed admissible for this paperless recorder; they do not provide the ground for warranty claims.

Electrical data

Voltage supply	AC 110 to 240 V +10/-15 %, 48 to 63 Hz or AC/DC 20 to 30 V, 48 to 63 Hz (not in conjunction with extra code 970)
Electrical safety	According to DIN EN 61010-1 Overvoltage category II to 300 V mains voltage, pollution degree 2
 Analog inputs of option "Analog(HI)/digital"	According to DIN EN 61010-1 Measuring category II (CAT II) up to AC 300 V (rms value, line to neutral) or DC 300 V mains voltage
Protection rating	I with internal isolation from SELV
Power consumption	
AC 110 to 240 V	< 45 VA
AC/DC 20 to 30 V	< 35 VA
Data backup	Internal flash memory
Data buffering	Battery (operating life > 7 years); additionally, storage capacitor for buffering during battery change (buffer time approx. 2 minutes)
Time	Battery-buffered real-time clock
Electrical connection	On the back via push-in spring-cage terminals
Conductor cross section on terminal 5	
Wire or stranded wire without ferrule	Min. 0.2 mm ² , max. 2.5 mm ²
Stranded wire with ferrule	Min. 0.2 mm ² , max. 2.5 mm ²
2 × stranded wire with twin ferrule with plastic collar	Min. 0.5 mm ² , max. 1.5 mm ² (both stranded wires with identical cross section)
Stripping length	10 mm
Conductor cross section on terminals 4, 24 to 29	
Wire or stranded wire without ferrule	Min. 0.2 mm ² , max. 2.5 mm ² (with terminal cover: max. 1.5 mm ²)
Stranded wire with ferrule	Min. 0.25 mm ² , max. 2.5 mm ² (with terminal cover: max. 1.5 mm ²)
Stripping length	10 mm
Conductor cross section on terminals 6 to 23	
Wire or stranded wire without ferrule	Min. 0.14 mm ² , max. 1.5 mm ² (with terminal cover: max. 0.5 mm ²)
Stranded wire with ferrule	Without plastic collar: min. 0.25 mm ² , max. 1.5 mm ² (with terminal cover: max. 0.5 mm ²) With plastic collar: min. 0.25 mm ² , max. 0.5 mm ²
Stripping length	9 mm

JUMO GmbH & Co. KG
 Delivery address: Mackenrodtstraße 14
 36039 Fulda, Germany
 Postal address: 36035 Fulda, Germany
 Phone: +49 661 6003-0
 Fax: +49 661 6003-607
 Email: mail@jumo.net
 Internet: www.jumo.net

JUMO UK LTD
 JUMO House
 Temple Bank, Riverway
 Harlow, Essex, CM20 2DY, UK
 Phone: +44 1279 63 55 33
 Fax: +44 1279 62 50 29
 Email: sales@jumo.co.uk
 Internet: www.jumo.co.uk

JUMO Process Control, Inc.
 6724 Joy Road
 East Syracuse, NY 13057, USA
 Phone: +1 315 437 5866
 Fax: +1 315 437 5860
 Email: info.us@jumo.net
 Internet: www.jumousa.com



Conductor cross section on terminals with small design (accessories)	
Wire without ferrule	Min. 0.2 mm ² , max. 1.5 mm ²
Stranded wire without ferrule	Min. 0.2 mm ² , max. 2.5 mm ² (with terminal cover: max. 1.5 mm ²)
Stranded wire with ferrule	Min. 0,25 mm ² , max. 1.5 mm ²
Stripping length	10 mm
Conductor cross section on TC terminal (accessories)	
Wire or stranded wire without ferrule	Min. 0,20 mm ² , max. 1,5 mm ² (with terminal cover: max. 0,5 mm ²)
Stranded wire with ferrule	Without plastic collar: min. 0,25 mm ² , max. 1,5 mm ² (with terminal cover: max. 0,5 mm ²) With plastic collar: min. 0,25 mm ² , max. 0,75 mm ² (with terminal cover: max. 0,5 mm ²)
Stripping length	10 mm

Environmental influences

Ambient temperature range	
Storage	-20 to +60 °C
Operation	-20 to +50 °C ^a ; in conjunction with extra code 970: 0 to 40 °C
Site altitude	Max. 2000 m above sea level
Climatic environmental influences	According to DIN EN 60721-3 with extended temperature range
Resistance to climatic conditions	≤ 85 % rel. humidity without condensation
Storage	According to class 1K2
Operation	According to class 3K3
Mechanical environmental influences	According to DIN EN 60721-3
Storage	According to class 1M2
Transport	According to class 2M2
Operation	According to class 3M3
Electromagnetic compatibility (EMC)	According to DIN EN 61326-1
Interference emission	Class A – only for industrial use –
Interference immunity	Industrial requirements

^a At temperatures below 0 °C, the build-up of screen contents slows down.

JUMO GmbH & Co. KG

Delivery address: Mackenrodtstraße 14
36039 Fulda, Germany
Postal address: 36035 Fulda, Germany
Phone: +49 661 6003-0
Fax: +49 661 6003-607
Email: mail@jumo.net
Internet: www.jumo.net

JUMO UK LTD

JUMO House
Temple Bank, Riverway
Harlow, Essex, CM20 2DY, UK
Phone: +44 1279 63 55 33
Fax: +44 1279 62 50 29
Email: sales@jumo.co.uk
Internet: www.jumo.co.uk

JUMO Process Control, Inc.

6724 Joy Road
East Syracuse, NY 13057, USA
Phone: +1 315 437 5866
Fax: +1 315 437 5860
Email: info.us@jumo.net
Internet: www.jumousa.com

**Case**

Case type	Flush-mounted housing according to DIN IEC 61554 made of zinc-plated steel sheet (indoor use)
Case front	Made of die-cast zinc with decor foil
Front frame dimensions	144 mm x 144 mm (front frame depth approx. 8 mm including seal)
Mounting depth	120.9 mm (incl. spring-cage terminals)
Panel cut-out	138 ^{+1.0} mm x 138 ^{+1.0} mm
Panel thickness	2 to 8 mm
Case fastening	In panel using the four supplied mounting elements
Operating position	Any, with due consideration for the viewing angle of the screen, horizontal $\pm 50^\circ$, vertical $\pm 30^\circ$
Protection type	According to DIN EN 60529, front IP66, back IP20; in conjunction with extra code 970: IP20 with open carrying case, IP20D with closed carrying case
Weight	Max. 1.75 kg (without terminal cover)

Approvals and approval marks

Approval mark	Testing facility	Certificate/certification number	Inspection basis	Valid for
c UL us	Underwriters Laboratories	E201387	UL 61010-1 (3. Ed.), CAN/CSA-22.2 No. 61010-1 (3rd Ed.)	All versions of the built-in device; not in conjunction with extra code 970

The device is approved if the approval mark is shown on the device.

JUMO GmbH & Co. KG
 Delivery address: Mackenrodtstraße 14
 36039 Fulda, Germany
 Postal address: 36035 Fulda, Germany
 Phone: +49 661 6003-0
 Fax: +49 661 6003-607
 Email: mail@jumo.net
 Internet: www.jumo.net

JUMO UK LTD
 JUMO House
 Temple Bank, Riverway
 Harlow, Essex, CM20 2DY, UK
 Phone: +44 1279 63 55 33
 Fax: +44 1279 62 50 29
 Email: sales@jumo.co.uk
 Internet: www.jumo.co.uk

JUMO Process Control, Inc.
 6724 Joy Road
 East Syracuse, NY 13057, USA
 Phone: +1 315 437 5866
 Fax: +1 315 437 5860
 Email: info.us@jumo.net
 Internet: www.jumousa.com



Dimensions

Device

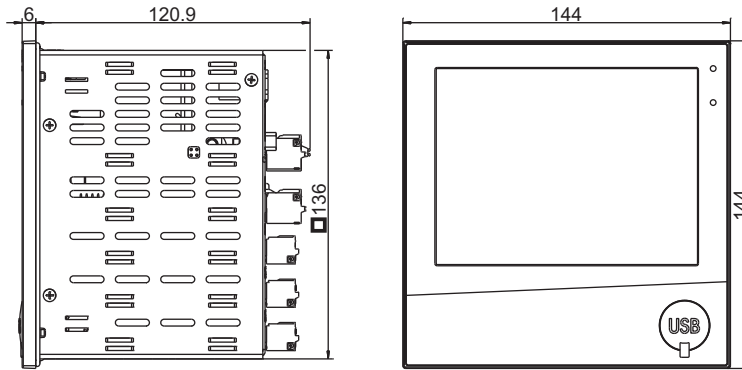

Panel cut-out

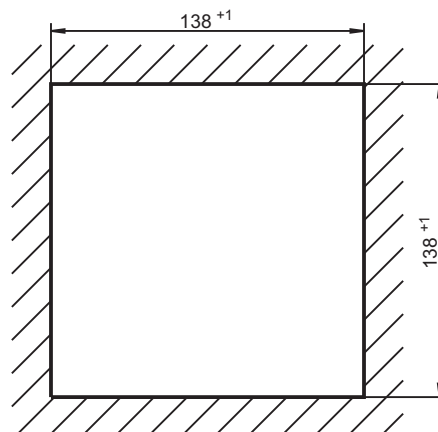

Close mounting

Distance between panel cut-outs	Horizontal	Vertical
Minimum clearance	20 mm	20 mm
Recommended distance (easier mounting of mounting elements)	50 mm	50 mm

Device with terminal cover (accessories)

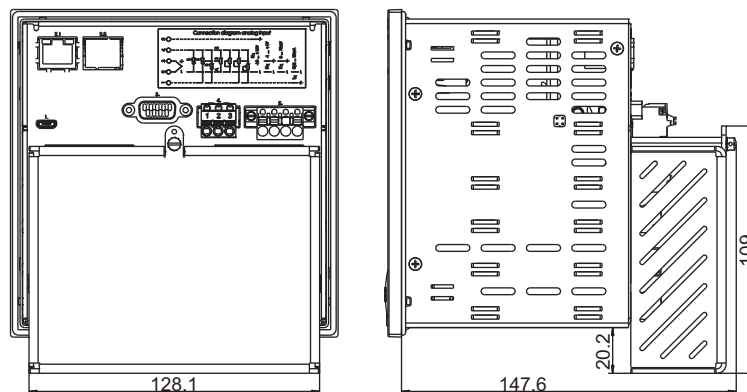

JUMO GmbH & Co. KG
Delivery address: Mackenrodtstraße 14
36039 Fulda, Germany
Postal address: 36035 Fulda, Germany
Phone: +49 661 6003-0
Fax: +49 661 6003-607
Email: mail@jumo.net
Internet: www.jumo.net

JUMO UK LTD
JUMO House
Temple Bank, Riverway
Harlow, Essex, CM20 2DY, UK
Phone: +44 1279 63 55 33
Fax: +44 1279 62 50 29
Email: sales@jumo.co.uk
Internet: www.jumo.co.uk

JUMO Process Control, Inc.
6724 Joy Road
East Syracuse, NY 13057, USA
Phone: +1 315 437 5866
Fax: +1 315 437 5860
Email: info.us@jumo.net
Internet: www.jumousa.com



Universal carrying case, compact (extra code 970)

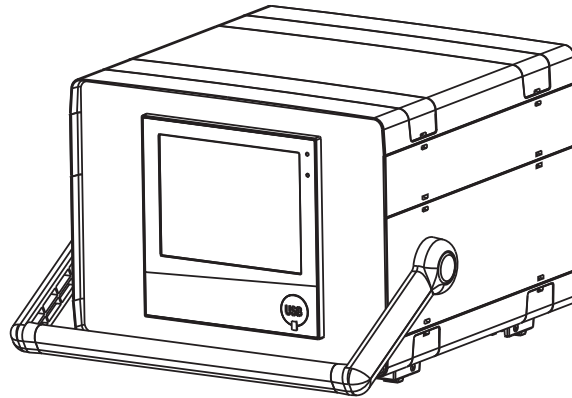

Dimensions

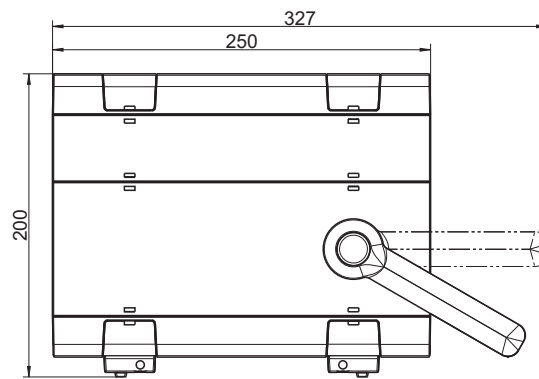
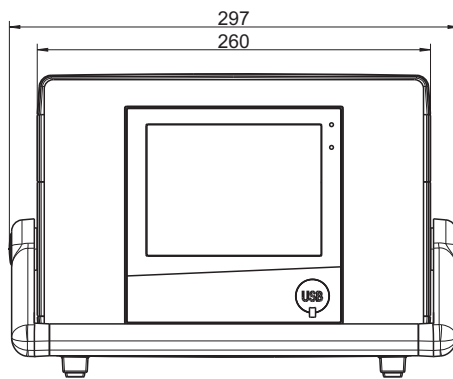



Galvanic isolation

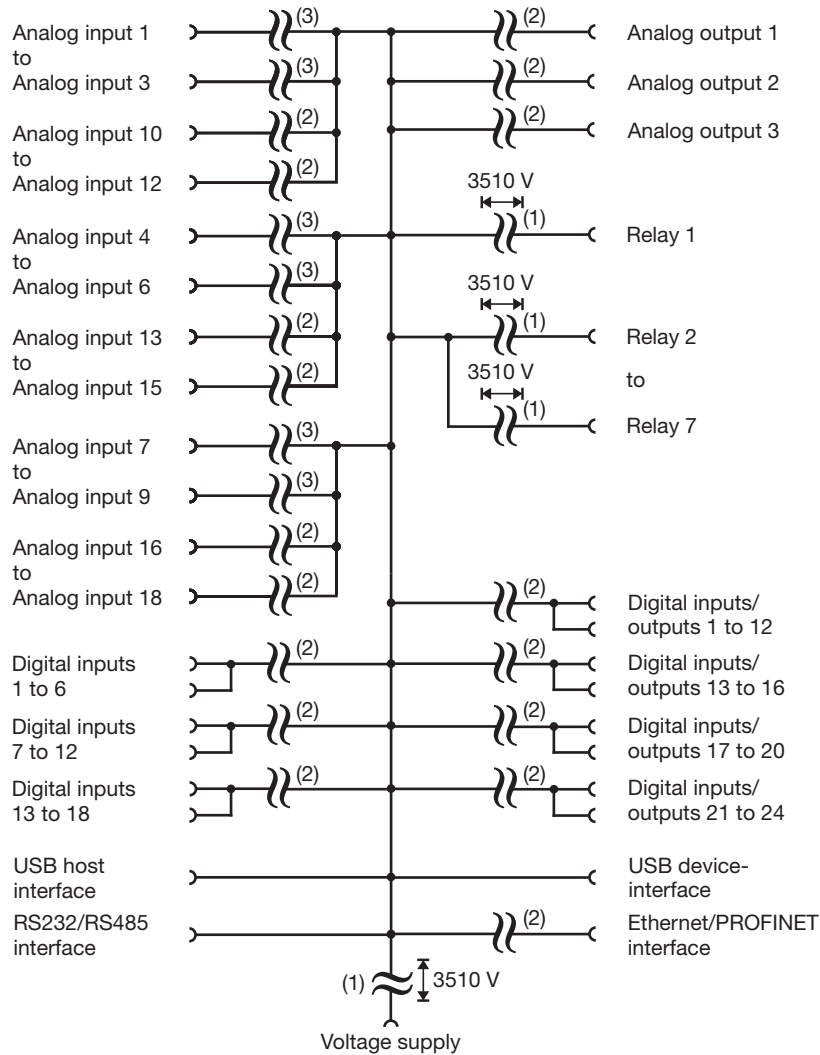

- 1 The voltage specifications correspond to the test voltages (alternating voltage, rms values) according to EN 61010-1:2011-07 for the type test.
- 2 Functional galvanic isolation for connection of SELV or PELV electrical circuits.
- 3 For the options "analog/digital" and "analog": functional galvanic isolation for connection of SELV or PELV electrical circuits.
 For the option "analog(HI)/digital": test voltage 3510 V (alternating voltage, rms value) according to EN 61010-1:2011-07 for the type test.

JUMO GmbH & Co. KG
 Delivery address: Mackenrodtstraße 14
 36039 Fulda, Germany
 Postal address: 36035 Fulda, Germany
 Phone: +49 661 6003-0
 Fax: +49 661 6003-607
 Email: mail@jumo.net
 Internet: www.jumo.net

JUMO UK LTD
 JUMO House
 Temple Bank, Riverway
 Harlow, Essex, CM20 2DY, UK
 Phone: +44 1279 63 55 33
 Fax: +44 1279 62 50 29
 Email: sales@jumo.co.uk
 Internet: www.jumo.co.uk

JUMO Process Control, Inc.
 6724 Joy Road
 East Syracuse, NY 13057, USA
 Phone: +1 315 437 5866
 Fax: +1 315 437 5860
 Email: info.us@jumo.net
 Internet: www.jumousa.com



Connection elements

Front USB host interface (without cover)



Back connection elements

This graphic shows an example with specific options.

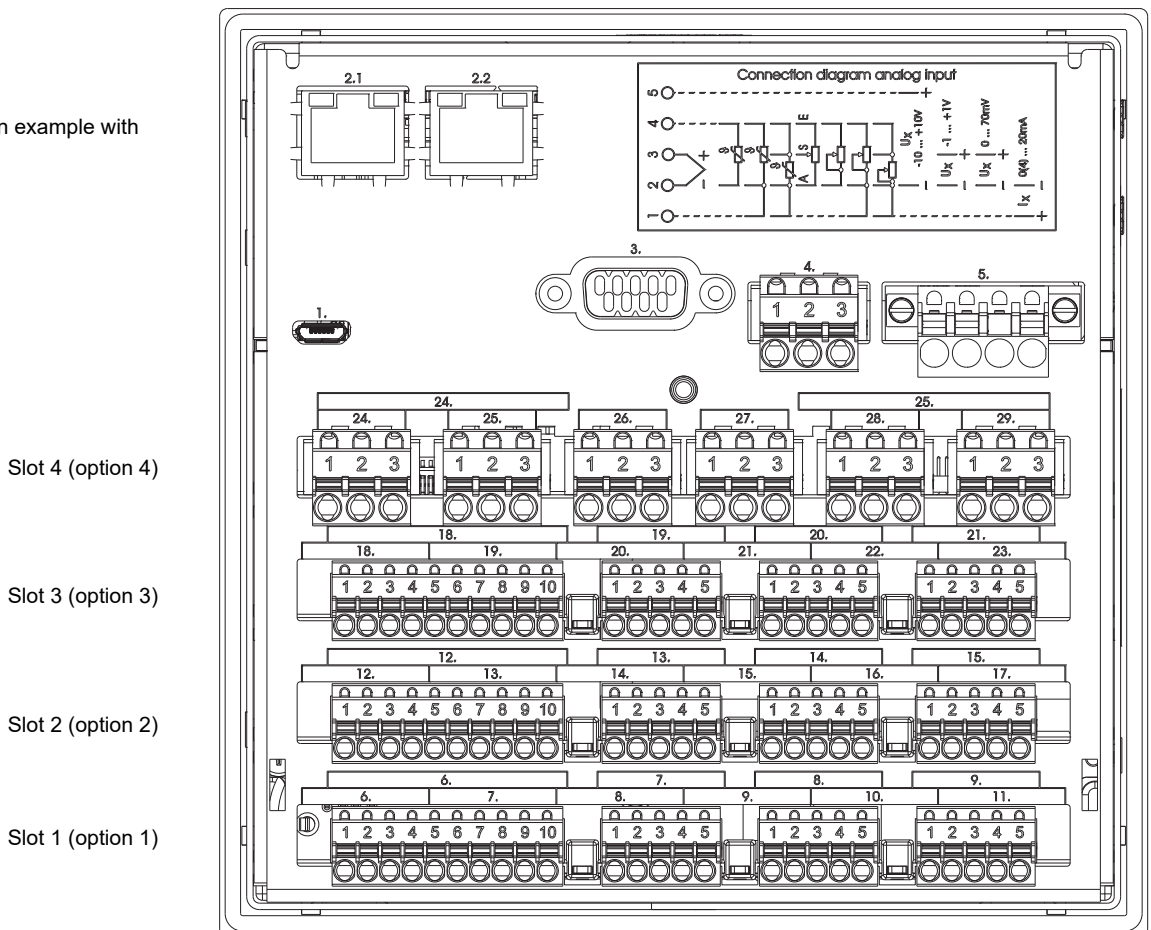

Slot 4 (option 4)

Slot 3 (option 3)

Slot 2 (option 2)

Slot 1 (option 1)

Connection element and assignment	
1.	USB device interface
2.1	Ethernet interface (as a standard feature) or
2.1,	PROFINET interface (including Ethernet; extra code):
2.2	2.1 = port 2, 2.2 = port 1
3.	RS232/RS485 interface

Connection element and assignment	
4.	Relay 1 (changeover contact)
5.	Voltage supply
6. -	Option inputs and outputs (Slot 1 to Slot 4)
29.	

JUMO GmbH & Co. KG
 Delivery address: Mackenrodtstraße 14
 36039 Fulda, Germany
 Postal address: 36035 Fulda, Germany
 Phone: +49 661 6003-0
 Fax: +49 661 6003-607
 Email: mail@jumo.net
 Internet: www.jumo.net

JUMO UK LTD
 JUMO House
 Temple Bank, Riverway
 Harlow, Essex, CM20 2DY, UK
 Phone: +44 1279 63 55 33
 Fax: +44 1279 62 50 29
 Email: sales@jumo.co.uk
 Internet: www.jumo.co.uk

JUMO Process Control, Inc.
 6724 Joy Road
 East Syracuse, NY 13057, USA
 Phone: +1 315 437 5866
 Fax: +1 315 437 5860
 Email: info.us@jumo.net
 Internet: www.jumousa.com



Connection diagram

The connection diagram in the data sheet provides preliminary information about the connection options. For the electrical connection, only use the quick start guide or the operating manual. The knowledge and the correct technical execution with the safety information and warnings contained in these documents are mandatory for mounting, electrical connection, and startup as well as for safety during operation.

Analog inputs

Measuring probe	Terminals and connection symbol	Connection element.terminal / assignment
Thermocouple		Analog/digital option (order code 1) or analog(HI)/digital option (order code 2): 7.1-5 / Analog input 1 8.1-5 / Analog input 2 9.1-5 / Analog input 3 13.1-5 / Analog input 4 14.1-5 / Analog input 5 15.1-5 / Analog input 6 19.1-5 / Analog input 7 20.1-5 / Analog input 8 21.1-5 / Analog input 9
RTD temperature probe Two-wire circuit		
RTD temperature probe Three-wire circuit		
RTD temperature probe Four-wire circuit		
Resistance transmitter		
Resistance/potentiometer Two-wire circuit		

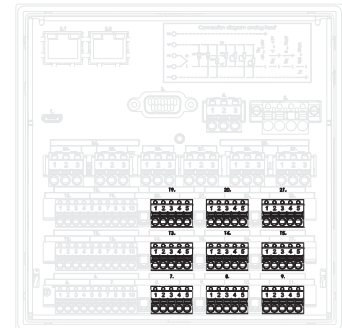

(Continued on the following page)

JUMO GmbH & Co. KG
 Delivery address: Mackenrodtstraße 14
 36039 Fulda, Germany
 Postal address: 36035 Fulda, Germany
 Phone: +49 661 6003-0
 Fax: +49 661 6003-607
 Email: mail@jumo.net
 Internet: www.jumo.net

JUMO UK LTD
 JUMO House
 Temple Bank, Riverway
 Harlow, Essex, CM20 2DY, UK
 Phone: +44 1279 63 55 33
 Fax: +44 1279 62 50 29
 Email: sales@jumo.co.uk
 Internet: www.jumo.co.uk

JUMO Process Control, Inc.
 6724 Joy Road
 East Syracuse, NY 13057, USA
 Phone: +1 315 437 5866
 Fax: +1 315 437 5860
 Email: info.us@jumo.net
 Internet: www.jumousa.com



Measuring probe	Terminals and connection symbol	Connection element.terminal / assignment
Resistance/potentiometer Three-wire circuit		Analog option (order code 3): 6.1-5 / Analog input 10 7.1-5 / Analog input 11 8.1-5 / Analog input 12 9.1-5 / Analog input 1 10.1-5 / Analog input 2 11.1-5 / Analog input 3 12.1-5 / Analog input 13 13.1-5 / Analog input 14 14.1-5 / Analog input 15 15.1-5 / Analog input 4 16.1-5 / Analog input 5 17.1-5 / Analog input 6 18.1-5 / Analog input 16 19.1-5 / Analog input 17 20.1-5 / Analog input 18 21.1-5 / Analog input 7 22.1-5 / Analog input 8 23.1-5 / Analog input 9
Resistance/potentiometer Four-wire circuit		
Voltage DC -10(0) to +10 V		
Voltage DC -1(0) to +1 V		
Voltage DC 0 to 70 mV		
Current DC 0(4) to 20 mA		

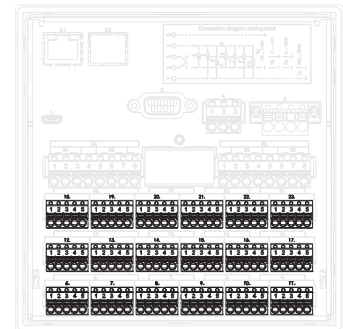

JUMO GmbH & Co. KG
 Delivery address: Mackenrodtstraße 14
 36039 Fulda, Germany
 Postal address: 36035 Fulda, Germany
 Phone: +49 661 6003-0
 Fax: +49 661 6003-607
 Email: mail@jumo.net
 Internet: www.jumo.net

JUMO UK LTD
 JUMO House
 Temple Bank, Riverway
 Harlow, Essex, CM20 2DY, UK
 Phone: +44 1279 63 55 33
 Fax: +44 1279 62 50 29
 Email: sales@jumo.co.uk
 Internet: www.jumo.co.uk

JUMO Process Control, Inc.
 6724 Joy Road
 East Syracuse, NY 13057, USA
 Phone: +1 315 437 5866
 Fax: +1 315 437 5860
 Email: info.us@jumo.net
 Internet: www.jumousa.com



Analog outputs

Version	Terminals and connection symbol	Connection element.terminal / assignment																																								
Analog output DC 0 to 10 V or DC 0(4) to 20 mA (configurable)	<div style="text-align: center;"> <table style="margin: auto;"> <tr> <td>1</td><td>2</td><td>3</td><td>4</td><td>5</td><td>6</td><td>7</td><td>8</td><td>9</td><td>10</td> </tr> <tr> <td>○</td><td>○</td><td>○</td><td>○</td><td>○</td><td>○</td><td>○</td><td>○</td><td>○</td><td>○</td> </tr> <tr> <td></td><td></td><td></td><td></td><td></td><td></td><td></td><td></td><td>U_x</td><td>I_x</td> </tr> <tr> <td></td><td></td><td></td><td></td><td></td><td></td><td></td><td></td><td>+</td><td>-</td> </tr> </table> </div>	1	2	3	4	5	6	7	8	9	10	○	○	○	○	○	○	○	○	○	○									U _x	I _x									+	-	Analog/digital option (order code 1): 6.9 / Analog output 1 + 6.10 / Analog output 1 - 12.9 / Analog output 2 + 12.10 / Analog output 2 - 18.9 / Analog output 3 + 18.10 / Analog output 3 -
1	2	3	4	5	6	7	8	9	10																																	
○	○	○	○	○	○	○	○	○	○																																	
								U _x	I _x																																	
								+	-																																	

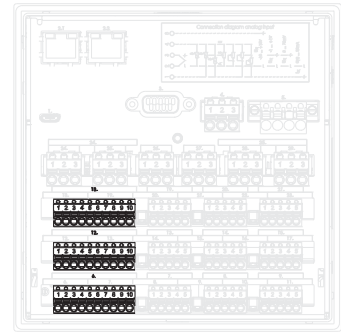

JUMO GmbH & Co. KG
 Delivery address: Mackenrodtstraße 14
 36039 Fulda, Germany
 Postal address: 36035 Fulda, Germany
 Phone: +49 661 6003-0
 Fax: +49 661 6003-607
 Email: mail@jumo.net
 Internet: www.jumo.net

JUMO UK LTD
 JUMO House
 Temple Bank, Riverway
 Harlow, Essex, CM20 2DY, UK
 Phone: +44 1279 63 55 33
 Fax: +44 1279 62 50 29
 Email: sales@jumo.co.uk
 Internet: www.jumo.co.uk

JUMO Process Control, Inc.
 6724 Joy Road
 East Syracuse, NY 13057, USA
 Phone: +1 315 437 5866
 Fax: +1 315 437 5860
 Email: info.us@jumo.net
 Internet: www.jumousa.com



Digital inputs

Version	Terminals and connection symbol	Connection element.terminal / assignment
Digital input DC 0/24 V, auxiliary voltage supply DC 24 V	<p>Example: potential-free contact on digital input 1 and +24 V (auxiliary voltage)</p> <p>Example: external voltage on digital input 1 and GND</p>	Analog/digital option (order code 1): 6.1 / Digital input 1 6.2 / Digital input 2 6.3 / Digital input 3 6.4 / Digital input 4 6.5 / Digital input 5 6.6 / Digital input 6 6.7 / +24 V 6.8 / GND 12.1 / Digital input 7 12.2 / Digital input 8 12.3 / Digital input 9 12.4 / Digital input 10 12.5 / Digital input 11 12.6 / Digital input 12 12.7 / +24 V 12.8 / GND 18.1 / Digital input 13 18.2 / Digital input 14 18.3 / Digital input 15 18.4 / Digital input 16 18.5 / Digital input 17 18.6 / Digital input 18 18.7 / +24 V 18.8 / GND

(Continued on the following page)

JUMO GmbH & Co. KG
 Delivery address: Mackenrodtstraße 14
 36039 Fulda, Germany
 Postal address: 36035 Fulda, Germany
 Phone: +49 661 6003-0
 Fax: +49 661 6003-607
 Email: mail@jumo.net
 Internet: www.jumo.net

JUMO UK LTD
 JUMO House
 Temple Bank, Riverway
 Harlow, Essex, CM20 2DY, UK
 Phone: +44 1279 63 55 33
 Fax: +44 1279 62 50 29
 Email: sales@jumo.co.uk
 Internet: www.jumo.co.uk

JUMO Process Control, Inc.
 6724 Joy Road
 East Syracuse, NY 13057, USA
 Phone: +1 315 437 5866
 Fax: +1 315 437 5860
 Email: info.us@jumo.net
 Internet: www.jumousa.com

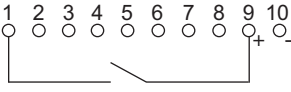
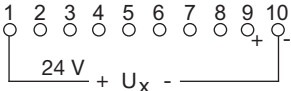
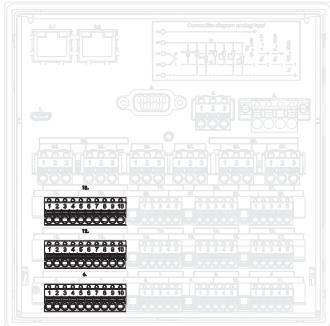

Version	Terminals and connection symbol	Connection element.terminal / assignment
Digital input DC 0/24 V, auxiliary voltage supply DC 24 V	 <p>Example: potential-free contact on digital input 1 and +24 V (auxiliary voltage)</p>  <p>Example: external voltage on digital input 1 and GND</p>	Analog(HI)/digital option (order code 2): 6.1 / Digital input 1 6.2 / Digital input 2 6.3 / Digital input 3 6.4 / Digital input 4 6.9 / +24 V 6.10 / GND 12.1 / Digital input 7 12.2 / Digital input 8 12.3 / Digital input 9 12.4 / Digital input 10 12.9 / +24 V 12.10 / GND 18.1 / Digital input 13 18.2 / Digital input 14 18.3 / Digital input 15 18.4 / Digital input 16 18.9 / +24 V 18.10 / GND 

JUMO GmbH & Co. KG
 Delivery address: Mackenrodtstraße 14
 36039 Fulda, Germany
 Postal address: 36035 Fulda, Germany
 Phone: +49 661 6003-0
 Fax: +49 661 6003-607
 Email: mail@jumo.net
 Internet: www.jumo.net

JUMO UK LTD
 JUMO House
 Temple Bank, Riverway
 Harlow, Essex, CM20 2DY, UK
 Phone: +44 1279 63 55 33
 Fax: +44 1279 62 50 29
 Email: sales@jumo.co.uk
 Internet: www.jumo.co.uk

JUMO Process Control, Inc.
 6724 Joy Road
 East Syracuse, NY 13057, USA
 Phone: +1 315 437 5866
 Fax: +1 315 437 5860
 Email: info.us@jumo.net
 Internet: www.jumousa.com

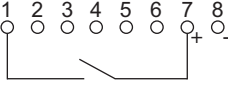
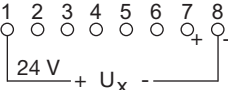
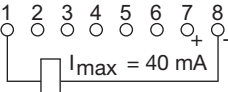
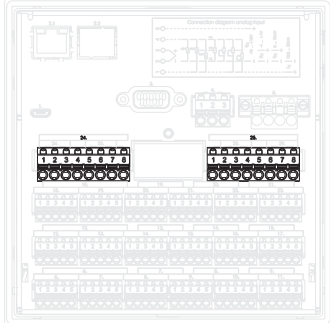

Digital inputs/outputs

Version	Terminals and connection symbol	Connection element.terminal / assignment
<p>Digital input DC 0/24 V or digital output DC 0/24 V (individually switchable), auxiliary voltage supply DC 24 V</p> <p>Note regarding the digital option: Auxiliary voltage supply and digital outputs together deliver max. 100 mA (at 24 V).</p>	 <p>Example: potential-free contact on digital input/output 1 (as input) and +24 V (auxiliary voltage)</p>  <p>Example: external voltage on digital input/output 1 (as input) and GND</p>  <p>Example: external relay on digital input/output 1 (as output) and GND (max. 40 mA per output, max. 100 mA in total, see note in the "Version" column)</p>	<p>Digital option (order code 4):</p> <p>24.1 / Digital input/output 1 24.2 / Digital input/output 2 24.3 / Digital input/output 3 24.4 / Digital input/output 4 24.5 / Digital input/output 5 24.6 / Digital input/output 6 24.7 / +24 V 24.8 / GND</p> <p>25.1 / Digital input/output 7 25.2 / Digital input/output 8 25.3 / Digital input/output 9 25.4 / Digital input/output 10 25.5 / Digital input/output 11 25.6 / Digital input/output 12 25.7 / +24 V 25.8 / GND</p> 

(Continued on the following page)

JUMO GmbH & Co. KG
 Delivery address: Mackenrodtstraße 14
 36039 Fulda, Germany
 Postal address: 36035 Fulda, Germany
 Phone: +49 661 6003-0
 Fax: +49 661 6003-607
 Email: mail@jumo.net
 Internet: www.jumo.net

JUMO UK LTD
 JUMO House
 Temple Bank, Riverway
 Harlow, Essex, CM20 2DY, UK
 Phone: +44 1279 63 55 33
 Fax: +44 1279 62 50 29
 Email: sales@jumo.co.uk
 Internet: www.jumo.co.uk

JUMO Process Control, Inc.
 6724 Joy Road
 East Syracuse, NY 13057, USA
 Phone: +1 315 437 5866
 Fax: +1 315 437 5860
 Email: info.us@jumo.net
 Internet: www.jumousa.com

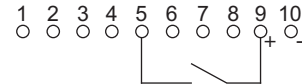
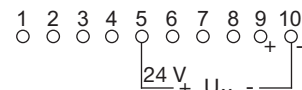
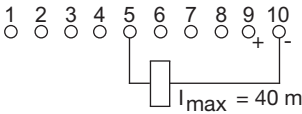
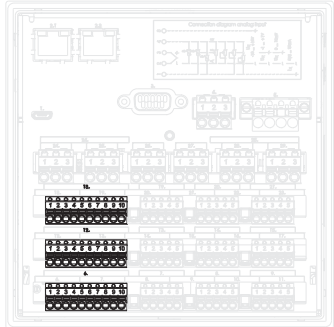

Version	Terminals and connection symbol	Connection element.terminal / assignment
<p>Digital input DC 0/24 V or digital output DC 0/24 V (individually switchable), auxiliary voltage supply DC 24 V</p> <p>Note regarding analog(HI)/digital option: Auxiliary voltage supply and digital outputs together deliver max. 50 mA per slot (at 24 V).</p>	 <p>Example: potential-free contact on digital input/output 13 (as input) and +24 V (auxiliary voltage)</p>  <p>Example: external voltage on digital input/output 13 (as input) and GND</p>  <p>Example: external relay on digital input/output 1 (as output) and GND (max. 40 mA per output, max. 50 mA in total, see note in the "Version" column)</p>	<p>Analog(HI)/digital option (order code 2):</p> <p>6.5 / Digital input/output 13 6.6 / Digital input/output 14 6.7 / Digital input/output 15 6.8 / Digital input/output 16 6.9 / +24 V 6.10 / GND</p> <p>12.5 / Digital input/output 17 12.6 / Digital input/output 18 12.7 / Digital input/output 19 12.8 / Digital input/output 20 12.9 / +24 V 12.10 / GND</p> <p>18.5 / Digital input/output 21 18.6 / Digital input/output 22 18.7 / Digital input/output 23 18.8 / Digital input/output 24 18.9 / +24 V 18.10 / GND</p> 

JUMO GmbH & Co. KG
 Delivery address: Mackenrodtstraße 14
 36039 Fulda, Germany
 Postal address: 36035 Fulda, Germany
 Phone: +49 661 6003-0
 Fax: +49 661 6003-607
 Email: mail@jumo.net
 Internet: www.jumo.net

JUMO UK LTD
 JUMO House
 Temple Bank, Riverway
 Harlow, Essex, CM20 2DY, UK
 Phone: +44 1279 63 55 33
 Fax: +44 1279 62 50 29
 Email: sales@jumo.co.uk
 Internet: www.jumo.co.uk

JUMO Process Control, Inc.
 6724 Joy Road
 East Syracuse, NY 13057, USA
 Phone: +1 315 437 5866
 Fax: +1 315 437 5860
 Email: info.us@jumo.net
 Internet: www.jumousa.com

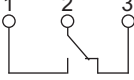
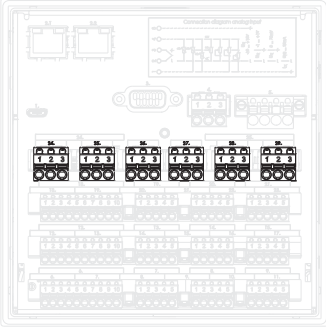

Relays

Version	Terminals and connection symbol	Connection element.terminal / assignment
Relay (changeover contact) (max. 3 A at AC 230 V, resistive load)		<p>As a standard feature:</p> <p>Relay 1: 4.1 / Normally open contact (NO) 4.2 / Common contact (C) 4.3 / Normally closed contact (NC)</p> <p>Relay option (order code 5):</p> <p>Relay 2: 24.1 / Normally open contact (NO) 24.2 / Common contact (C) 24.3 / Normally closed contact (NC)</p> <p>Relay 3: 25.1 / Normally open contact (NO) 25.2 / Common contact (C) 25.3 / Normally closed contact (NC)</p> <p>Relay 4: 26.1 / Normally open contact (NO) 26.2 / Common contact (C) 26.3 / Normally closed contact (NC)</p> <p>Relay 5: 27.1 / Normally open contact (NO) 27.2 / Common contact (C) 27.3 / Normally closed contact (NC)</p> <p>Relay 6: 28.1 / Normally open contact (NO) 28.2 / Common contact (C) 28.3 / Normally closed contact (NC)</p> <p>Relay 7: 29.1 / Normally open contact (NO) 29.2 / Common contact (C) 29.3 / Normally closed contact (NC)</p> 

JUMO GmbH & Co. KG
 Delivery address: Mackenrodtstraße 14
 36039 Fulda, Germany
 Postal address: 36035 Fulda, Germany
 Phone: +49 661 6003-0
 Fax: +49 661 6003-607
 Email: mail@jumo.net
 Internet: www.jumo.net

JUMO UK LTD
 JUMO House
 Temple Bank, Riverway
 Harlow, Essex, CM20 2DY, UK
 Phone: +44 1279 63 55 33
 Fax: +44 1279 62 50 29
 Email: sales@jumo.co.uk
 Internet: www.jumo.co.uk

JUMO Process Control, Inc.
 6724 Joy Road
 East Syracuse, NY 13057, USA
 Phone: +1 315 437 5866
 Fax: +1 315 437 5860
 Email: info.us@jumo.net
 Internet: www.jumousa.com



RS232/RS485 interface

Version	Connection element.pin / assignment	Connection element
RS232 9-pin SUB-D socket (switchable to RS485)	3.2 / RxD (received data) 3.3 / TxD (transmission data) 3.5 / GND (ground)	
RS485 9-pin SUB-D socket (switchable to RS232)	3.3 / TxD+/RxD+ (transmission/received data +) 3.5 / GND (ground) 3.8 / TxD-/RxD- (transmission/received data -)	

Ethernet/PROFINET

Version	Connection element.pin / assignment	Connection element
Ethernet 1 x RJ45 (as a standard feature)	2.1.1 / TX+ (transmission data +) 2.1.2 / TX- (transmission data -) 2.1.3 / RX+ (received data +) 2.1.6 / RX- (received data -)	
PROFINET IO device (incl. Ethernet) 2 x RJ45, integrated switch (as extra code)	Port 2: 2.1.1 / TX+ (transmission data +) 2.1.2 / TX- (transmission data -) 2.1.3 / RX+ (received data +) 2.1.6 / RX- (received data -) Port 1: 2.2.1 / TX+ (transmission data +) 2.2.2 / TX- (transmission data -) 2.2.3 / RX+ (received data +) 2.2.6 / RX- (received data -)	

Voltage supply

Version	Connection element.terminal / assignment	Terminals and connection symbol
AC 110 to 240 V +10/-15 %, 48 to 63 Hz or AC/DC 20 to 30 V, 48 to 63 Hz Observe order details!	5.L1 / Line conductor (for DC: positive terminal L+) 5.N / Neutral conductor (for DC: negative terminal L-) 5.PE / Protection conductor	

JUMO GmbH & Co. KG
 Delivery address: Mackenrodtstraße 14
 36039 Fulda, Germany
 Postal address: 36035 Fulda, Germany
 Phone: +49 661 6003-0
 Fax: +49 661 6003-607
 Email: mail@jumo.net
 Internet: www.jumo.net

JUMO UK LTD
 JUMO House
 Temple Bank, Riverway
 Harlow, Essex, CM20 2DY, UK
 Phone: +44 1279 63 55 33
 Fax: +44 1279 62 50 29
 Email: sales@jumo.co.uk
 Internet: www.jumo.co.uk

JUMO Process Control, Inc.
 6724 Joy Road
 East Syracuse, NY 13057, USA
 Phone: +1 315 437 5866
 Fax: +1 315 437 5860
 Email: info.us@jumo.net
 Internet: www.jumousa.com



Order details

(1) Basic type	
706530	Paperless recorder with the following interfaces: 1x Ethernet, 2x USB (1x host, 1x device), 1x RS232/485 interface, as well as a relay (changeover contact)
(2) Basic type extension	
0	Without software package
1	With software package (setup program incl. USB cable, PC Evaluation Software PCA3000, PCA Communication Software PCC; in conjunction with extra code "888" as well with PC Security Manager PCS and PC Audit Trail Manager PCAT software)
(3) Language	
8	Default setting (German/English)
9	Set according to customer specifications
(4) Option 1 (slot 1)^a	
0	Not used
1	Analog/digital: 3 analog and 6 digital inputs, 1 analog output
2	Analog(HI)/digital: 3 analog (HI) ^b and 4 digital inputs, 4 digital inputs/outputs
3	Analog: 6 analog inputs
(5) Option 2 (slot 2)^a	
0	Not used
1	Analog/digital: 3 analog and 6 digital inputs, 1 analog output
2	Analog(HI)/digital: 3 analog (HI) ^b and 4 digital inputs, 4 digital inputs/outputs (individually switchable)
3	Analog: 6 analog inputs
(6) Option 3 (slot 3)^a	
0	Not used
1	Analog/digital: 3 analog and 6 digital inputs, 1 analog output
2	Analog(HI)/digital: 3 analog (HI) ^b and 4 digital inputs, 4 digital inputs/outputs (individually switchable)
3	Analog: 6 analog inputs
(7) Option 4 (slot 4)^a	
0	Not used
4	Digital: 12 digital inputs/outputs (individually switchable)
5	Relay: 6 relay outputs (changeover contact)
(8) Voltage supply	
23	AC 110 to 240 V +10/-15 %, 48 to 63 Hz
25	AC/DC 20 to 30 V, 48 to 63 Hz
(9) Extra code 1	
.	Not used
260	Math and logic module (20 channels each)
221	Structured text (ST code)
(10) Extra code 2	
.	Not used
887	Manipulation detection with digital certificate
888	FDA 21 CFR Part 11 with digital certificate
(11) Extra code 3	
.	Not used
163	PROFINET IO device interface (incl. Ethernet)
879	AMS2750/CQI-9 ^c
(12) Extra code, housing	
.	Not used
949	TUS/SAT field test device ^d
970	Universal carrying case, compact ^e

^a Subsequent expansion is only possible in JUMO Central Services.

JUMO GmbH & Co. KG
 Delivery address: Mackenrodtstraße 14
 36039 Fulda, Germany
 Postal address: 36035 Fulda, Germany
 Phone: +49 661 6003-0
 Fax: +49 661 6003-607
 Email: mail@jumo.net
 Internet: www.jumo.net

JUMO UK LTD
 JUMO House
 Temple Bank, Riverway
 Harlow, Essex, CM20 2DY, UK
 Phone: +44 1279 63 55 33
 Fax: +44 1279 62 50 29
 Email: sales@jumo.co.uk
 Internet: www.jumo.co.uk

JUMO Process Control, Inc.
 6724 Joy Road
 East Syracuse, NY 13057, USA
 Phone: +1 315 437 5866
 Fax: +1 315 437 5860
 Email: info.us@jumo.net
 Internet: www.jumousa.com



- b Analog inputs with increased electric strength (AC 300 V).
- c For the calibration certificate it is necessary to state the channels along with the thermocouple type and the desired measuring points. The device is to be used as a permanently installed field device. Use as a mobile field test device for SAT and TUS testing is not permitted.
 For use as a TUS/SAT field test device, the device must be ordered with the extra code 949. In this case, the channels to be checked must also be stated, indicating the thermocouple type. It is not necessary to specify the measuring points.
- d The use of the carrying case (extra code 970) is recommended to prevent temperature fluctuations at the cold junctions caused by air drafts.
- e The extra code is only available in conjunction with voltage supply AC 110 to 240 V. The UL approval does not apply. Use only for personnel with technical qualifications who have been specially trained, and have the relevant knowledge in the field of automation technology! Specifications for ambient temperature and for protection type are to be observed (see technical data)!

Order code (1) (2) (3) (4) (5) (6) (7) (8) (9)^a (10) (11)^a (12)^a
 _____ / _____ - _____ - _____ / _____ , _____ , _____ , _____

Order example 706530 / 1 8 - 1 2 3 4 - 23 / 260 , 887 , 163 , 970

^a Multiple selection at positions 9, 11, and 12 is possible. Specify extra codes one after the other, and separate them with commas.

Scope of delivery

1 paperless recorder in the ordered version
1 quick start guide (brief instructions)
4 mounting elements

Accessories

Description	Part no.
Setup program	00645110
USB cable, A connector to Micro-B connector, length 3 m	00616250
PC Evaluation Software PCA3000	00431882
PCA communication software PCC	00431879
PC software package consisting of: setup program, PC Evaluation Software PCA3000, PCA Communication Software PCC, PC Security Manager PCS, PC Audit Trail Manager PCAT. Please specify all version numbers when placing follow-up orders.	00666817
USB flash drive, 2 GB ^a	00505592
Activation for math and logic module (setup program required)	00716354
Activation for structured text (ST code; setup program required)	00716357
Activation, automatic printout (PCA3000)	00505548
TP-Link TL-WR802N (Wi-Fi router)	00658592
Sealable terminal cover	00712239
Relay (N/O contact) AC 230 V / 3 A for DIN rail	00515872
3 TC terminals (2-pole) with integrated cold junction ^b , usable for slot 1 to slot 3	30053080
2 terminals (8-pole, small design) for slot 4 (digital inputs/outputs) ^c	30053605
6 terminals (3-pole, small design) for slot 4 (relay outputs) ^c	30053606

^a The indicated USB flash drive has been tested and is designed for industrial applications. Other brands with larger storage capacity can also be used, but no liability is assumed for this.

^b The TC terminals with integrated cold junction are used to connect thermocouples for high-precision temperature measurement (usable as of version 323.04.05 of the device software).

^c The terminals with small design are used as a replacement for the default terminals at slot 4. They are needed to increase the distance to the terminals at slot 3 so that the TC terminals can be used there.