

# Operating Instructions

**Radar sensor for continuous level measurement**

## **VEGAPULS Air 41**

Autarkic device with measured value transmission via radio technology



Document ID: 64808



**VEGA**

# Contents

<b>1</b>	<b>About this document</b> .....	<b>4</b>
1.1	Function .....	4
1.2	Target group .....	4
1.3	Symbols used.....	4
<b>2</b>	<b>For your safety</b> .....	<b>5</b>
2.1	Authorised personnel .....	5
2.2	Intended use .....	5
2.3	Warning about incorrect use.....	5
2.4	General safety instructions .....	5
2.5	Lithium battery.....	6
2.6	Country of use - mobile network, LoRaWan .....	6
2.7	Mode of operation - Radar signal .....	6
<b>3</b>	<b>Product description</b> .....	<b>7</b>
3.1	Configuration.....	7
3.2	Principle of operation.....	8
3.3	Adjustment .....	9
3.4	Packaging, transport and storage.....	10
3.5	Accessories.....	11
<b>4</b>	<b>Mounting</b> .....	<b>12</b>
4.1	General instructions .....	12
4.2	Mounting instructions .....	12
<b>5</b>	<b>Access protection</b> .....	<b>17</b>
5.1	Bluetooth radio interface .....	17
5.2	Protection of the parameterization.....	17
5.3	Storing the codes in myVEGA .....	18
<b>6</b>	<b>Setup - the most important steps</b> .....	<b>19</b>
<b>7</b>	<b>Onboarding</b> .....	<b>21</b>
7.1	Onboarding on activation with VEGA Inventory System app .....	21
7.2	Onboarding on activation with magnet .....	23
<b>8</b>	<b>Operating modes, activate, device functions</b> .....	<b>26</b>
8.1	Operating modes.....	26
8.2	Activate .....	26
8.3	Network Join, measurement function .....	27
8.4	Single measurement .....	28
8.5	Localization .....	28
8.6	Deactivate .....	29
<b>9</b>	<b>Transfer measured values and data to the cloud</b> .....	<b>30</b>
9.1	Communication basics.....	30
9.2	NB-IoT/LTE-M - VEGA Inventory System .....	30
9.3	LoRaWAN (Fall back) - VEGA Inventory System .....	31
9.4	NB-IoT/LTE-M - VEGA Cloud .....	32
9.5	LoRaWAN - private networks .....	32
<b>10</b>	<b>Setup with smartphone/tablet (Bluetooth)</b> .....	<b>33</b>
10.1	Preparations.....	33
10.2	Connecting.....	33

10.3	Parameter adjustment .....	34
<b>11</b>	<b>Setup with PC/notebook (Bluetooth) .....</b>	<b>36</b>
11.1	Preparations .....	36
11.2	Connecting .....	36
11.3	Parameter adjustment .....	37
<b>12</b>	<b>Set up measuring point via the VEGA Inventory System app .....</b>	<b>39</b>
<b>13</b>	<b>Operate device via VEGA Inventory System .....</b>	<b>41</b>
<b>14</b>	<b>Menu overview .....</b>	<b>42</b>
<b>15</b>	<b>Diagnostics and servicing .....</b>	<b>46</b>
15.1	Maintenance .....	46
15.2	Rectify faults .....	46
15.3	Status messages according to NE 107 .....	47
15.4	Treatment of measurement errors .....	49
15.5	Exchange battery .....	53
15.6	Software update .....	54
15.7	Security Update .....	54
15.8	How to proceed if a repair is necessary .....	54
<b>16</b>	<b>Dismount .....</b>	<b>56</b>
16.1	Dismounting steps .....	56
16.2	Disposal .....	56
<b>17</b>	<b>Certificates and approvals .....</b>	<b>57</b>
17.1	Radio licenses .....	57
17.2	Approvals for Ex areas .....	57
17.3	Conformity .....	57
17.4	Environment management system .....	57
<b>18</b>	<b>Supplement .....</b>	<b>59</b>
18.1	Technical data .....	59
18.2	Radio networks LTE-M and NB-IoT .....	63
18.3	Radio networks LoRaWAN - Data transmission .....	63
18.4	Dimensions .....	67
18.5	Industrial property rights .....	68
18.6	Licensing information for open source software .....	68
18.7	Trademark .....	68

# 1 About this document

## 1.1 Function

This instruction provides all the information you need for mounting, connection and setup as well as important instructions for maintenance, fault rectification, safety and the exchange of parts. Please read this information before putting the instrument into operation and keep this manual accessible in the immediate vicinity of the device.

## 1.2 Target group

This instruction manual is directed to trained personnel. The contents of this manual must be made available to the qualified personnel and implemented.

## 1.3 Symbols used



### Document ID

This symbol on the front page of this instruction refers to the Document ID. By entering the Document ID on [www.vega.com](http://www.vega.com) you will reach the document download.



**Information, note, tip:** This symbol indicates helpful additional information and tips for successful work.



**Note:** This symbol indicates notes to prevent failures, malfunctions, damage to devices or plants.



**Caution:** Non-observance of the information marked with this symbol may result in personal injury.



**Warning:** Non-observance of the information marked with this symbol may result in serious or fatal personal injury.



**Danger:** Non-observance of the information marked with this symbol results in serious or fatal personal injury.



### Ex applications

This symbol indicates special instructions for Ex applications.



### List

The dot set in front indicates a list with no implied sequence.



### Sequence of actions

Numbers set in front indicate successive steps in a procedure.



### Disposal

This symbol indicates special instructions for disposal.

## 2 For your safety

### 2.1 Authorised personnel

All operations described in this documentation must be carried out only by trained and authorized personnel.

During work on and with the device, the required personal protective equipment must always be worn.

### 2.2 Intended use

The VEGAPULS Air 41 is an autarkic sensor for continuous level measurement.

You can find detailed information about the area of application in chapter "*Product description*".

Operational reliability is ensured only if the instrument is properly used according to the specifications in the operating instructions manual as well as possible supplementary instructions.

### 2.3 Warning about incorrect use

Inappropriate or incorrect use of this product can give rise to application-specific hazards, e.g. vessel overfill through incorrect mounting or adjustment. Damage to property and persons or environmental contamination can result. Also, the protective characteristics of the instrument can be impaired.

### 2.4 General safety instructions

This is a state-of-the-art instrument complying with all prevailing regulations and directives. The instrument must only be operated in a technically flawless and reliable condition. The operating company is responsible for the trouble-free operation of the instrument. When measuring aggressive or corrosive media that can cause a dangerous situation if the instrument malfunctions, the operating company has to implement suitable measures to make sure the instrument is functioning properly.

The safety instructions in this operating instructions manual, the national installation standards as well as the valid safety regulations and accident prevention rules must be observed.

For safety and warranty reasons, any invasive work on the device beyond that described in the operating instructions manual may be carried out only by personnel authorised by us. Arbitrary conversions or modifications are explicitly forbidden. For safety reasons, only the accessory specified by us must be used.

To avoid any danger, the safety approval markings and safety tips on the device must also be observed.

The low transmitting power of the radar sensor as well as the integrated LTE-NB1, LTE-CAT-M1 or LoRa radio module is far below the internationally approved limits. No health impairments are to be expected with intended use. The band range of the transmission frequency can be found in chapter "*Technical data*".

## 2.5 Lithium battery

The power supply of the device is provided by a replaceable lithium battery. If the device is used as intended with the lid closed within the temperatures and pressures specified in the technical data, it is thus adequately protected.

**Note:**

Please observe the specific safety instructions in the scope of delivery of the device.

## 2.6 Country of use - mobile network, LoRaWan

Country-specific settings for transmission to the mobile network or LoRaWan are defined by selecting the country or region of use. It is therefore mandatory to set the country or region of use during the order-specific device configuration or at the start of setup in the operating menu via the respective adjustment tool.

**Caution:**

Operation of the device without a correct country or region of use selection can lead to malfunctions and constitutes a violation of the radio licensing regulations of the respective country or region.

## 2.7 Mode of operation - Radar signal

Country or region specific settings for the radar signals are determined via the mode. The operating mode must be set in the operating menu via the respective operating tool at the beginning of the setup.

**Caution:**

Operating the device without selecting the relevant mode constitutes a violation of the regulations of the radio approvals of the respective country or region.

Further information is available in the document "*Radio licenses*" on our homepage.

The available radio approvals can be found on our homepage.

### 3 Product description

#### 3.1 Configuration

##### Scope of delivery

The scope of delivery encompasses:

- Radar sensor
- Integrated identification card for LTE (eSIM) (optional)
- Magnet for activation
- Information sheet "*Documents and software*" with:
  - Instrument serial number
  - QR code with link for direct scanning
- Information sheet "*PINs and Codes*" with:
  - Bluetooth access code
  - Identifier for LoRaWAN network (Device EUI, Application EUI, App Key)
- Information sheet "*Access protection*" with:
  - Bluetooth access code
  - Network access code (authentication/encryption for mobile radio)
  - Emergency Bluetooth unlock code
  - Emergency device code
  - Identifier for LoRaWAN network (Device EUI, Application EUI, App Key)

The further scope of delivery encompasses:

- Documentation
  - Safety instructions for lithium metal battery
  - If necessary, further certificates



##### Information:

Optional instrument features are also described in this instructions. The respective scope of delivery results from the order specification.

##### Constituent parts

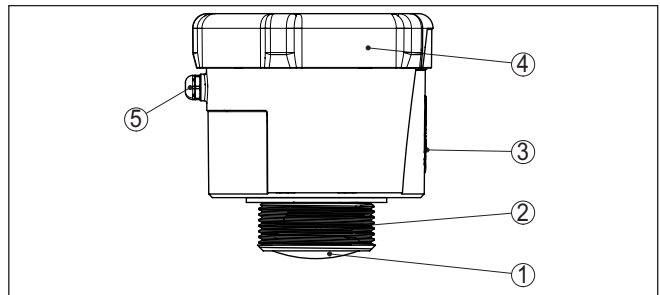

Fig. 1: Components of the VEGAPULS Air 41 sensor - Example version with thread G1½

- 1 Radar antenna
- 2 Process fitting
- 3 Contact surface for NFC communication
- 4 Cover
- 5 Ventilation

<b>Type label</b>	<p>The type label contains the most important data for identification and use of the instrument:</p> <ul style="list-style-type: none"> <li>● Instrument type</li> <li>● Information about approvals</li> <li>● Configuration information</li> <li>● Technical data</li> <li>● Serial number of the instrument</li> <li>● QR code for device identification</li> <li>● Numerical code for Bluetooth access (optional)</li> <li>● Manufacturer information</li> </ul>
<b>Documents and software</b>	<p>To find order data, documents or software related to your device, you have the following options:</p> <ul style="list-style-type: none"> <li>● Move to "<a href="http://www.vega.com">www.vega.com</a>" and enter in the search field the serial number of your instrument.</li> <li>● Scan the QR code on the type label.</li> <li>● Open the VEGA Tools app and enter the serial number under "<b>Documentation</b>".</li> </ul>

### 3.2 Principle of operation

<b>Application area</b>	<p>VEGAPULS Air 41 is an autarkic radar sensor with radio technology for continuous level measurement on vessels and tanks.</p> <p>The device is suitable for almost all liquids as well as for bulk solids. Depending on the version, mounting is carried out via thread:</p> <ul style="list-style-type: none"> <li>● G1½</li> <li>● 1½ NPT</li> <li>● R1½</li> </ul>
<b>Functional principle</b>	<p>The measurement is carried out through a suitable nozzle opening on the vessel.</p> <p>The sensor emits a radar signal through the antenna. The emitted signal is reflected by the medium and received as an echo by the antenna.</p> <p>The resulting level is converted into a respective output signal and wirelessly transmitted.</p> <p>The measuring cycle is time-controlled via the integrated clock. Outside of the measuring cycle, the device is in a sleep mode.</p>
<b>Measured value transmission</b>	<p>Depending on the availability of the radio networks and version, the device transmits its measured values wirelessly to an LTE-M (LTE-CAT-M1) or NB-IoT (LTE-CAT-NB1) mobile radio or a plant-side LoRaWAN network.</p> <p>These versions are available:</p> <ul style="list-style-type: none"> <li>● Cellular (LTE-M/NB-IoT) + LoRa</li> <li>● Cellular (LTE-M/NB-IoT)</li> <li>● LoRa</li> </ul>

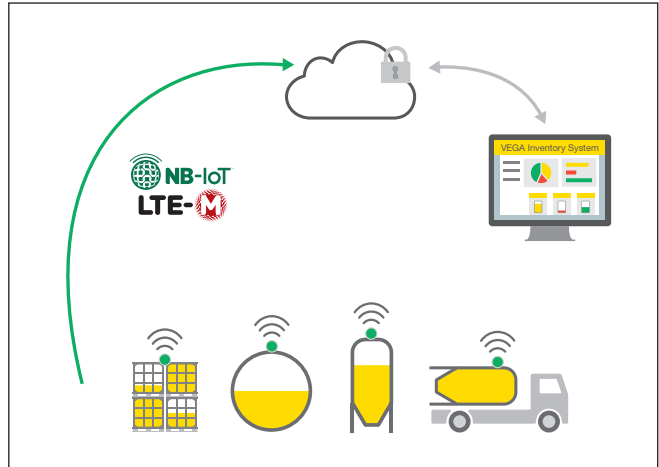

Fig. 2: Wireless measured value transmission via mobile radio

The transmission or evaluation is carried out via an Asset Management System, e.g. VEGA Inventory System.

**Voltage supply**

The VEGAPULS Air 41 is powered by a replaceable battery.

**3.3 Adjustment**

**Activation**

The device is activated contactlessly from outside:

- Via magnet
- By NFC technology via smartphone with VEGA Tools app

**Adjustment**

The device has an integrated Bluetooth module, can be operated wirelessly using standard operating tools:

- Smartphone/tablet (iOS or Android operating system)
- PC/notebook with Bluetooth USB adapter (Windows operating system)

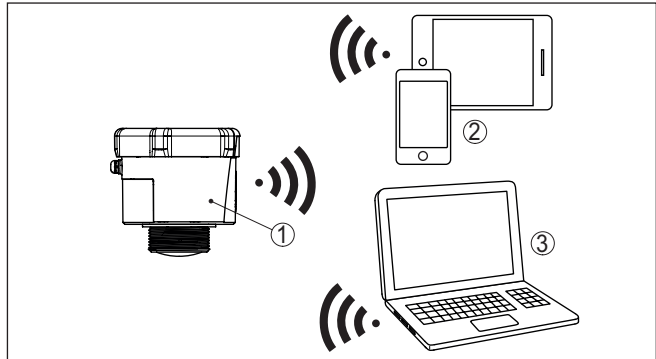

Fig. 3: Wireless connection to standard operating devices via Bluetooth

- 1 Sensor
- 2 Smartphone/Tablet
- 3 PC/Notebook

### 3.4 Packaging, transport and storage

#### Packaging

Your instrument was protected by packaging during transport. Its capacity to handle normal loads during transport is assured by a test based on ISO 4180.

The packaging consists of environment-friendly, recyclable cardboard. For special versions, PE foam or PE foil is also used. Dispose of the packaging material via specialised recycling companies.

#### Transport

Transport must be carried out in due consideration of the notes on the transport packaging. Nonobservance of these instructions can cause damage to the device.

#### Transport inspection

The delivery must be checked for completeness and possible transit damage immediately at receipt. Ascertained transit damage or concealed defects must be appropriately dealt with.

#### Storage

Up to the time of installation, the packages must be left closed and stored according to the orientation and storage markings on the outside.

Unless otherwise indicated, the packages must be stored only under the following conditions:

- Not in the open
  - Dry and dust free
  - Not exposed to corrosive media
  - Protected against solar radiation
  - Avoiding mechanical shock and vibration
- Storage and transport temperature see chapter "*Technical data - Ambient conditions*"
  - Relative moisture 20 ... 85 %

#### Storage and transport temperature

### 3.5 Accessories

#### Mounting strap

The mounting accessories are used for stable mounting of the device at the measuring point. The parts are available in various versions and sizes.

#### LoRa-Gateway

The LoRa gateway receives via LoRaWAN the measurement and diagnosis data of appropriately configured VEGA LoRaWAN sensors. The gateway combines the received data and transmits them via mobile network to the VEGA Inventory System.

The measured values and messages are transmitted via the mobile network.

#### VEGA Inventory System

VEGA Inventory System is a web-based software for simple acquisition, presentation and further processing of measured values.

The measured values are transmitted to the central server via network, internet or cellular radio.

## 4 Mounting

### 4.1 General instructions

#### Ambient conditions

The instrument is suitable for standard and extended ambient conditions acc. to DIN/EN/BS EN/IEC/ANSI/ISA/UL/CSA 61010-1. It can be used indoors as well as outdoors.

#### Process conditions



#### Note:

For safety reasons, the instrument must only be operated within the permissible process conditions. You can find detailed information on the process conditions in chapter "Technical data" of the operating instructions or on the type label.

Hence make sure before mounting that all parts of the instrument exposed to the process are suitable for the existing process conditions.

#### Measurement function and transport

An activated device (see chapter "Activate device") also carries out measurements in horizontal alignment. This also applies if it is mounted on a mobile container and the container is transported in a tilted state.



#### Note:

When mounting the device on a mobile container, ensure that it is protected against damage throughout transport.

### 4.2 Mounting instructions

#### Polarisation

Radar sensors for level measurement emit electromagnetic waves. The polarisation is the direction of the electrical component of these waves.

The position of the polarisation is in the middle of the type label on the instrument.

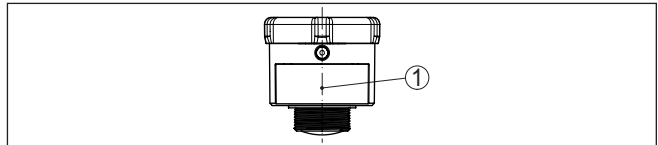

Fig. 4: Position of the polarisation

1 Middle of the type label



#### Note:

When the device is rotated, the direction of polarization changes and hence the influence of the false echo on the measured value. Please keep this in mind when mounting or making changes later.

#### Installation position

When mounting the device, keep a distance of at least 200 mm (7.874 in) from the vessel wall. If the device is installed in the center of dished or round vessel tops, multiple echoes can arise. However, these can be suppressed by an appropriate adjustment (see chapter "Setup").

If you cannot maintain this distance, you should carry out a false signal suppression during setup. This applies particularly if buildup on the vessel wall is expected. In such cases, we recommend repeating the false signal suppression at a later date with existing buildup.

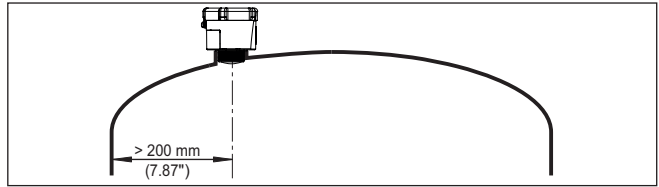

Fig. 5: Mounting of the radar sensor on round vessel tops

In vessels with conical bottom it can be advantageous to mount the device in the centre of the vessel, as measurement is then possible down to the bottom.

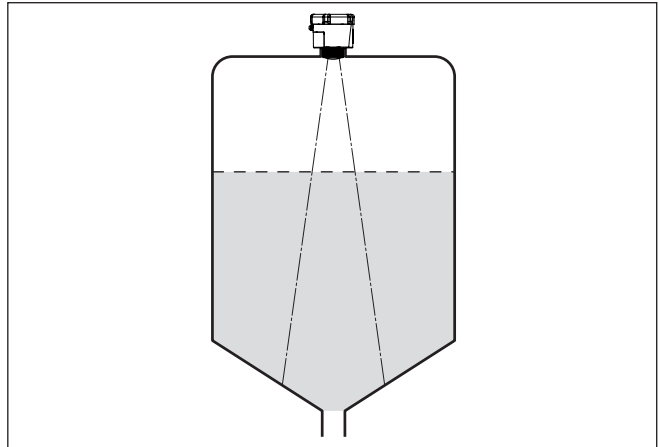

Fig. 6: Mounting of the radar sensor on vessels with conical bottom

**Reference plane**

The sealing surface at the bottom of the hexagon is the beginning of the measuring range and at the same time the reference plane for the min./max. adjustment, see the following graphic:

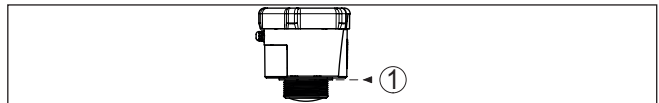

Fig. 7: Reference plane

1 Reference plane

**Nozzle**

For nozzle mounting, the nozzle should be as short as possible and its end rounded. This reduces false reflections from the nozzle.

The antenna edge should protrude at least 5 mm (0.2 in) out of the nozzle.

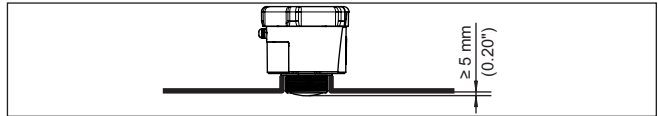

Fig. 8: Recommended socket mounting of VEGAPULS Air 41

If the reflective properties of the medium are good, you can mount VEGAPULS Air 41 on sockets longer than the antenna. The socket end should be smooth and burr-free, if possible also rounded.



#### Note:

When mounting on longer nozzles, we recommend carrying out a false signal suppression (see chapter "Parameter adjustment").

You will find recommended values for socket heights in the following illustration or the table. The values come from typical applications. Deviating from the proposed dimensions, also longer sockets are possible, however the local conditions must be taken into account.

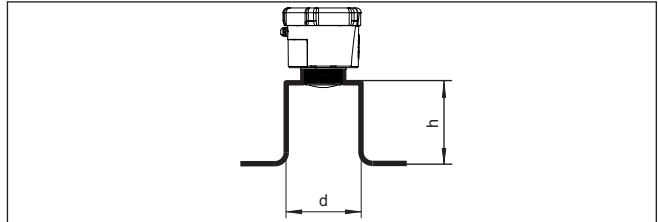

Fig. 9: Socket mounting with deviating socket dimensions

Socket diameter d		Socket length h	
80 mm	3"	≤ 300 mm	≤ 11.8 in
100 mm	4"	≤ 400 mm	≤ 15.8 in
150 mm	6"	≤ 600 mm	≤ 23.6 in

### Alignment - Liquids

In liquids, direct the device as perpendicular as possible to the medium surface to achieve optimum measurement results.

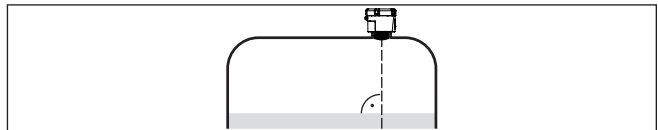

Fig. 10: Alignment in liquids

### Orientation - Bulk solids

In order to measure as much of the vessel volume as possible, the device should be aligned so that the radar signal reaches the lowest level in the vessel. In a cylindrical silo with conical outlet, the sensor is mounted anywhere from one third to one half of the vessel radius from the outside wall (see following drawing).

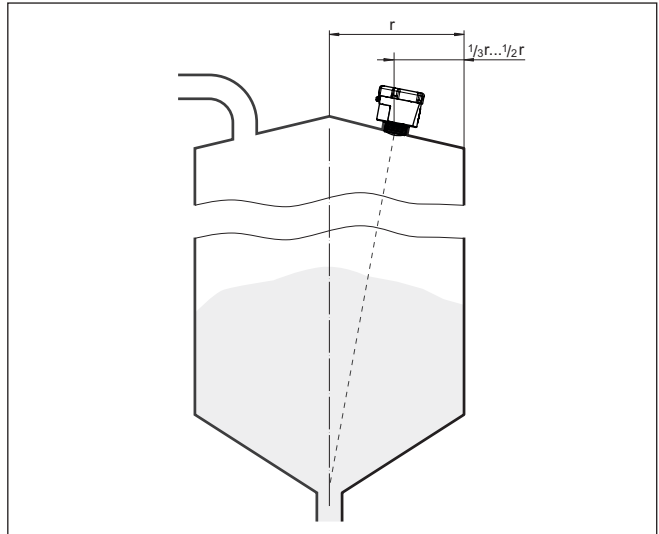

Fig. 11: Mounting position and orientation

**Orientation**

Due to respective socket design or with an alignment device, the device can be easily aligned to the vessel centre. The necessary angle of inclination depends on the vessel dimensions. It can be easily checked with a suitable bubble tube or mechanic's level on the sensor.

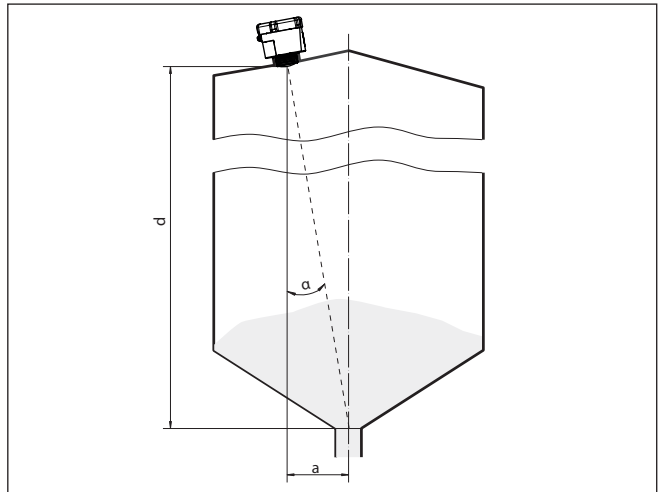

Fig. 12: Proposal for installation after orientation VEGAPULS Air 41

The following table shows the necessary angle of inclination. It depends on the measuring distance and the distance "a" between vessel centre and installation position.

Distance d (m)	2°	4°	6°	8°	10°
2	0.1	0.1	0.2	0.3	0.4
4	0.1	0.3	0.4	0.6	0.7
6	0.2	0.4	0.6	0.8	1.1
8	0.3	0.6	0.8	1.1	1.4
10	0.3	0.7	1.1	1.4	1.8
15	0.5	1	1.6	2.1	2.6

**Example:**

In a vessel 10 m high, the installation position of the sensor is 0.7 m from the vessel centre.

The necessary angle of inclination of 4° can be read out from this table.

## 5 Access protection

### 5.1 Bluetooth radio interface

Devices with a Bluetooth radio interface are protected against unwanted access from outside. This means that only authorized persons can receive measured and status values and change device settings via this interface.

#### Bluetooth access code

A Bluetooth access code is required to establish Bluetooth communication via the adjustment tool (smartphone/tablet/notebook). This code must be entered once when Bluetooth communication is established for the first time in the adjustment tool. It is then stored in the adjustment tool and does not have to be entered again.

The Bluetooth access code is individual for each device. It is printed on the device housing with Bluetooth. In addition, it is supplied with the device in the information sheet "*PINs and Codes*". In addition, the Bluetooth access code can be read out via the display and adjustment unit, depending on the device version.

The Bluetooth access code can be changed by the user after the first connection is established. If the Bluetooth access code is entered incorrectly, the new entry is only possible after a waiting period has elapsed. The waiting time increases with each further incorrect entry.

#### Emergency Bluetooth unlock code

The emergency Bluetooth access code enables Bluetooth communication to be established in the event that the Bluetooth access code is no longer known. It can't be changed. The emergency Bluetooth access code can be found in information sheet "*Access protection*". If this document is lost, the emergency Bluetooth access code can be retrieved from your personal contact person after legitimation. The storage and transmission of Bluetooth access codes is always encrypted (SHA 256 algorithm).

### 5.2 Protection of the parameterization

The settings (parameters) of the device can be protected against unwanted changes. The parameter protection is deactivated on delivery, all settings can be made.

#### Device code

To protect the parameterization, the device can be locked by the user with the aid of a freely selectable device code. The settings (parameters) can then only be read out, but not changed. The device code is also stored in the adjustment tool. However, unlike the Bluetooth access code, it must be re-entered for each unlock. When using the adjustment app or DTM, the stored device code is then suggested to the user for unlocking.

#### Emergency device code

The emergency device code allows unlocking the device in case the device code is no longer known. It can't be changed. The emergency device code can also be found on the supplied information sheet "*Access protection*". If this document is lost, the emergency device code can be retrieved from your personal contact person after legitimation.



The storage and transmission of the device codes is always encrypted (SHA 256 algorithm).

### **5.3 Storing the codes in myVEGA**

If the user has a "myVEGA" account, then the Bluetooth access code as well as the device code are additionally stored in his account under "*PINs and Codes*". This greatly simplifies the use of additional adjustment tools, as all Bluetooth access and device codes are automatically synchronized when connected to the "myVEGA" account

## 6 Setup - the most important steps



### Prerequisites

What?	How?
Account in the VEGA Inventory System 	Available from your VEGA contact person
User role supervisor 	Is assigned by your VEGA Inventory System administrator
VEGA Tools app, VEGA Inventory System app 	Download via Apple App Store, Google Play Store, Baidu Store

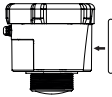

### Activate the sensor

Via magnet	Via smartphone (VEGA Tools app or VEGA Inventory System app)
Move the supplied magnet along the line towards the housing lid 	Call up NFC communication, hold the smartphone close to the side of the device with the lettering "VEGA" 

### Set up measuring point in the VEGA Inventory System

Web portal	VEGA Inventory System app
	
Menu item "Device networks - Add" - Enter serial number and device name	Menu item "Add device" - Scan QR code on device or enter serial number manually

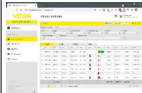
**Configure sensor**

<p><b>Web portal</b></p> 	<p><b>VEGA Inventory System app</b></p> 
<p>Menu item "<i>Adjustment/linearization</i>" - Open assistant (measuring range and transmission interval via VEGA Tools app)</p>	<p>Complete wizard with Linearisation/adjustment</p>

## 7 Onboarding

### 7.1 Onboarding on activation with VEGA Inventory System app

1. Open VEGA Inventory System on the Smartphone and log in with the supervisor account.



2. Press "**Add device**".

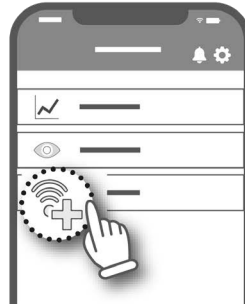

3. Select the sensor type to be activated.

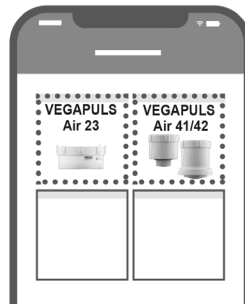

4. Press button "**NFC scan**".

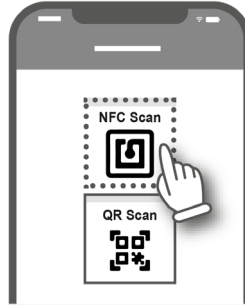

5. Place the smartphone on the side of the housing to the VEGA logo.

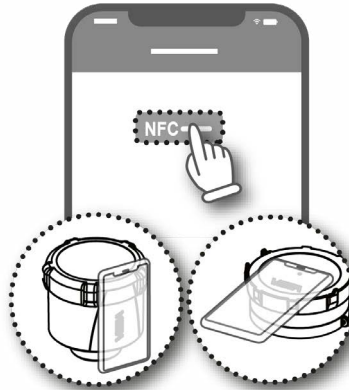

6. Enter device name (e.g. silo number).  
The serial number of VEGAPULS Air 41 is automatically accepted by the app.  
Save setting.

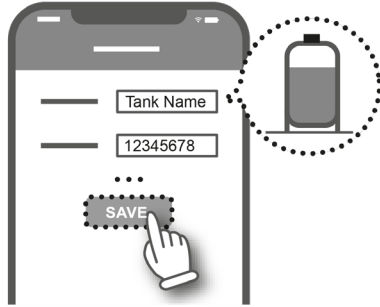

- Assign a linearization to VEGAPULS Air 41.  
To do this, either link an existing linearization or create a new linearization.

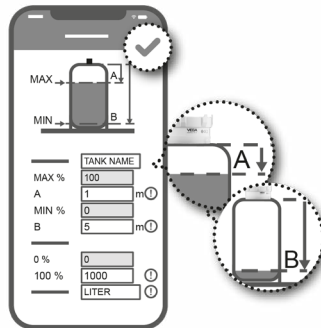

The onboarding of the sensor is completed. The VEGAPULS Air 41 is integrated in the VEGA Inventory System.

## 7.2 Onboarding on activation with magnet

- Open lid of VEGAPULS Air 41.

2. Move the activation magnet along the right notch until the red LED inside the VEGAPULS Air 41 flashes.

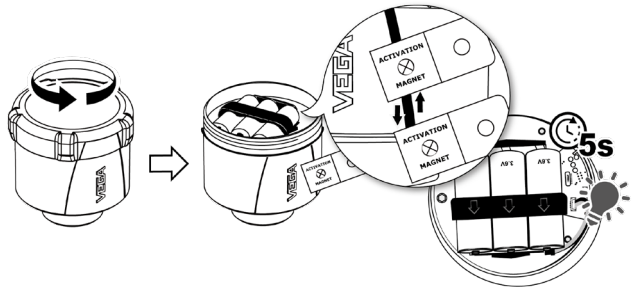

3. Close VEGAPULS Air 41 again.  
Make sure that the notches on the lid and the housing match.

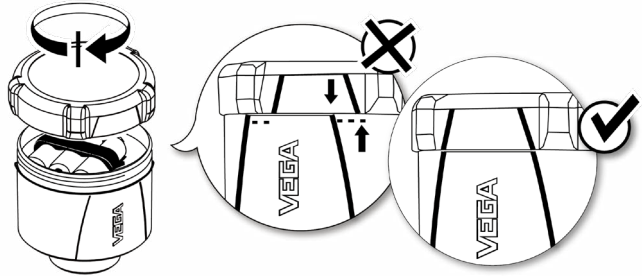

4. Open "[vis.vega.com](https://vis.vega.com)" and log in with the supervisor account.
5. Open "**Configuration - Device networks**" and press "**Add**".

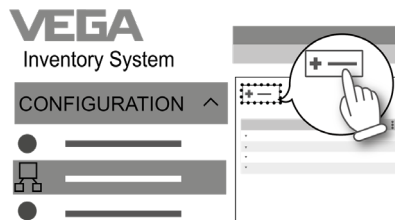

6. Enter serial number and device name (e.g. silo number) of VEGAPULS Air 41 and save.

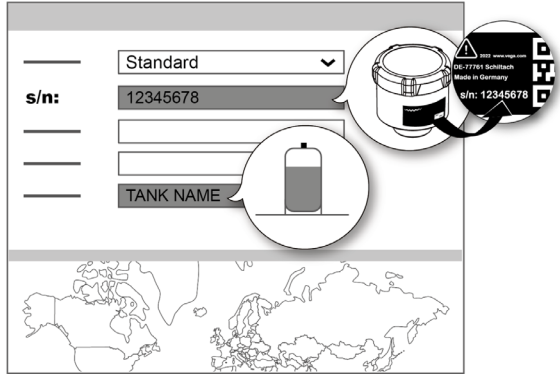

7. Open "**Configuration - Adjustment/Linearization**" and assign a linearization to VEGAPULS Air 41.

To do this, either link an existing linearization or create a new linearization with the linearization assistant.

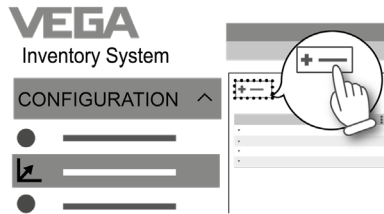

The onboarding of the sensor is completed. The VEGAPULS Air 41 is integrated in the VEGA Inventory System.

## 8 Operating modes, activate, device functions

### 8.1 Operating modes

The VEGAPULS Air 41 has the following operating modes that can be set via operating tools:

- Deactivated
- Activated



#### Note:

On delivery, the device is in the deactivated state and must be activated for operation using a smartphone or magnet.

#### Deactivated

In the deactivated state, the device is not woken up by the integrated clock despite a set measuring interval.

The fact that the sensor does not wake up and does not carry out measurement cycles or communication means that the battery is not unnecessarily discharged. In this state, longer storage is possible until the device is used.

#### Activated

In the activated state, the device is not woken up by the integrated clock within the set measuring interval.

The activation is described in the following.

### 8.2 Activate

#### Activate

The following options are available for activating the device from the deactivated delivery status:

- By smartphone with VEGA Tools app via NFC
- Via magnet

#### By smartphone

Proceed as follows for activation by NFC:

1. Start VEGA Tools app on smartphone
2. Open menu "**Sensor activation**"
3. Hold the adjustment tool tightly on the instrument side with the lettering "VEGA"

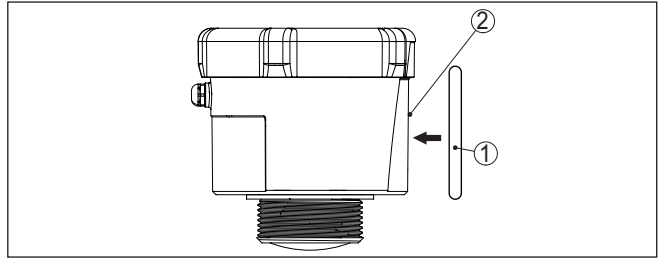

Fig. 13: Activate the sensor

- 1 Adjustment tool, e.g. smartphone
- 2 Contact surface for NFC communication

The app confirms successful activation and the device is ready for a radio connection for 60 seconds.

**Via magnet**

Proceed as follows for activation by magnet:

1. Hold the magnet next to the lettering "VEGA" close to the side of the device
2. Move the magnet as shown below along the line towards the housing lid

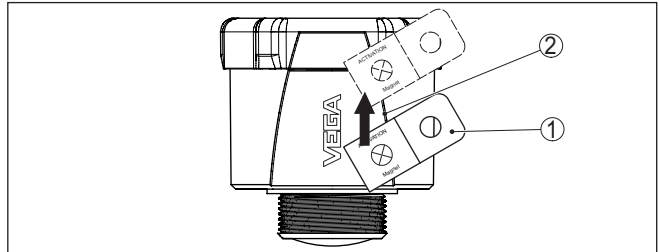

Fig. 14: Activate sensor by magnet

- 1 Contact point for activation
- 2 Magnet

The device is ready for a radio connection for 60 s.



**Note:**

If no Bluetooth connection is established within these 60 seconds, the device automatically returns to sleep mode. If an established Bluetooth connection is interrupted, a new connection is possible for a further 10 seconds, etc.

**8.3 Network Join, measurement function**

After activation, the VEGAPULS Air 41 - if set to LoRa and an existing LoRaWAN network - carries out an automatic, single join to the network server. The device is added to the network as an end device by means of Device EUI and Application EUI.

<b>Measured value transmission</b>	After activation, a single measurement is carried out and the cyclic measurement interval is started. The measured value is sent once via LoRaWAN or mobile radio. The sensor delivers the distance value from the sealing surface of the thread or flange lower side to the product surface. The conversion into level is carried out, for example, in the VEGA Inventory System on the application server or in a cloud service.
<b>Cyclic measuring operation</b>	In the activated state, the device is woken up via the integrated clock and carries out a measurement cycle (measurement and transmission). The measurement and transmission interval runs on the basis of the factory preconfiguration or a configuration set by the user. Afterwards, the device automatically enters the energy-saving sleep state.
	<p><b>Note:</b></p> <p> In sleep mode, it is not possible to connect to the device via Bluetooth.</p>
<b>Event-controlled measurement and transmission</b>	If an adjustable distance value is exceeded, the device can carry out measurements and send data more frequently. This makes it possible to obtain more measurement data when the level is in a range that requires more attention. As soon as the level is outside this measuring range again, the device switches to regular cyclic measuring operation.

## 8.4 Single measurement

The device offers the possibility to test the communication in the respective network. The current measured value is determined and transmitted once outside the cyclic transmission. In addition, a LoRa Join and a single location determination is carried out.

The procedure is done by new activation via NFC or magnet as described above. The sensor is simultaneously activated for the cyclical transmission of measured values. The transmission cycle of an already activated sensor is not changed by this.

## 8.5 Localization

<b>Function</b>	The LTE-M/NB-IoT version of the device has the function " <i>Location determination</i> ". This is carried out via an integrated GPS receiver. The function " <i>Location determination</i> " can be switched on or off via the VEGA Tools app or PACTware/DTM.
-----------------	---

**Note:**

 With the LoRa version of the device, the function "*Location*" is not available.

<b>Triggering</b>	Tilting or raising the device triggers a single location determination. A position of 65° to the vertical must be passed through. Furthermore, entering a new mobile radio cell triggers a single location determination. In both cases, location determination is not started until the next cyclic measured value determination. If no GPS signal is found within 180 s and therefore no position is determined, the process is aborted.
-------------------	--

## **8.6 Deactivate**

The instrument can be deactivated via the VEGA Tools app or the DTM, e.g. for temporary shutdown. The device is reactivated as described above.

## 9 Transfer measured values and data to the cloud

### 9.1 Communication basics

To transmit the measured values and data to the cloud, the device requires access to mobile network or a LoRaWAN network at the installation site, depending on the version. If no corresponding network is available, a LoRaWAN gateway must be installed.

**Note:**

Ensure free access to the radio network. The device must not be covered by metal or even enclosed. This especially for the medium height of the housing.

**Note:**

Simultaneous operation of LTE-M or LTE-IoT and LoRaWAN is not supported.

The following measured values or data are available:

- Distance to the medium surface
- Adjusted measured value
- Linearised measured value
- Scaled measured value
- Electronics temperature
- Geographical position determined by GPS (geographical coordinates)
- Mounting position (angle °)
- Remaining battery life (%)
- Device status

**Information:**

Adjustment, linearization and scaling of the measured value are configured in the VEGA Inventory System.

For LoRa sensors transmitting into private networks, adjustment, linearization and scaling are configured in the VEGA Tools app.

The transmission options are described below.

### 9.2 NB-IoT/LTE-M - VEGA Inventory System

With NB-IoT (Narrowband Internet of Things) and LTE-M (Long Term Evolution for Machines), the focus is on low data rates and high transmission ranges. Another focus is on penetrating propagation obstacles, such as buildings, for which the long-wave signal is well suited.

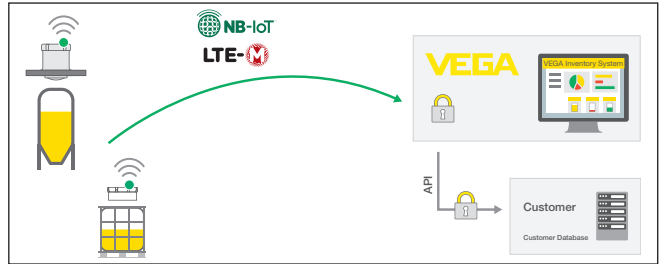

Fig. 15: Wireless measured value transmission via NB-IoT and LTE-M to the VEGA Inventory System

Data is sent via an eSIM card integrated in the sensor. This card sends the data via mobile network directly to the VEGA Inventory System. If no mobile network is available, a fallback to LoRa takes place automatically (see below).

After data transmission via the mobile network, the sensors are automatically made known in the VEGA Inventory System via their serial number. As soon as the sensors are integrated there, the data are available for visualisation.

### 9.3 LoRaWAN (Fall back) - VEGA Inventory System

LoRaWAN (Long Range Wide Area Network) is the data transmission mode that is available when the mobile network in the area of the measuring point fails. However, this requires a corresponding gateway. This gateway picks up the data via LoRa from the sensors and transmits them via mobile radio to VEGA's own LoRa server.

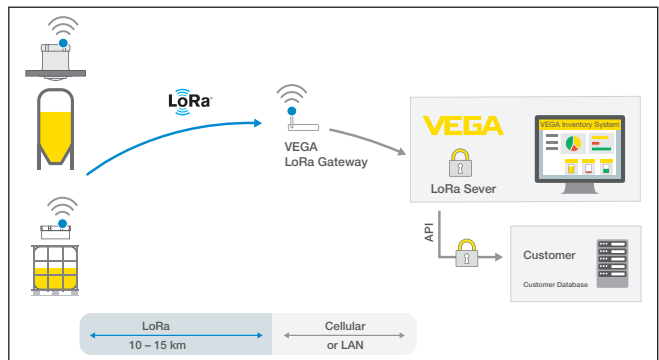

Fig. 16: Wireless measured value transmission via LoRaWAN, LoRa server to the VEGA Inventory System

Both the end devices and the gateways are stored there with their data. The sensors and gateways have so-called Device EUIs via which they can be clearly identified. The LoRa server then transmits the data to the VEGA Inventory System.

## 9.4 NB-IoT/LTE-M - VEGA Cloud

Data is sent via an eSIM card integrated in the sensor. This card sends the data via the mobile network directly to the VEGA cloud.

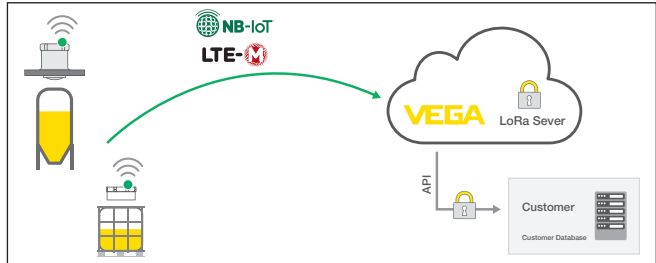

Fig. 17: Wireless measured value transmission via NB-IoT and LTE-M to the VEGA cloud

## 9.5 LoRaWAN - private networks

Another possibility is to send the data via the user's private LoRaWAN network. In this case, the sensor must be made known in this network.

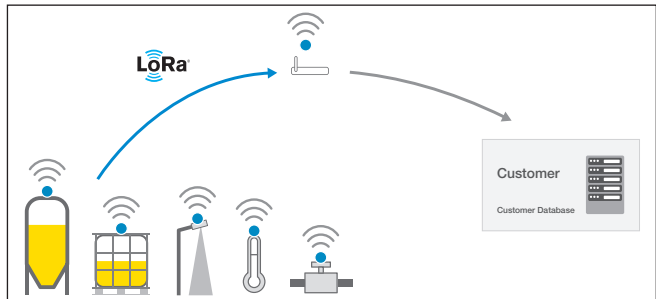

Fig. 18: Wireless measured value transmission

To do this, the user creates the sensor in his interface with its identification values (DevEUI, AppKey and JoinEUI). After a "Join" has been triggered, the sensor appears in the user interface. The transmitted bytes are described in chapter "*Radio network LoRaWAN - data transmission*" and are decoded accordingly in the application system.

## 10 Setup with smartphone/tablet (Bluetooth)

### 10.1 Preparations

#### System requirements

Make sure that your smartphone/tablet meets the following system requirements:

- Operating system: iOS 13 or newer
- Operating system: Android 5.1 or newer
- Bluetooth 4.0 LE or newer

Download the VEGA Tools app from the "Apple App Store", "Google Play Store" or "Baidu Store" to your smartphone or tablet.

#### Device activated

Make sure that the VEGAPULS Air 41 is activated, see chapter "Operating modus, activate device".

### 10.2 Connecting

#### Connecting

Start the adjustment app and select the function "Setup". The smartphone/tablet searches automatically for Bluetooth-capable instruments in the area.

The message "Connecting ..." is displayed.

The devices found are listed and the search is automatically continued.

Select the requested instrument in the device list.

#### Authenticate

When establishing the connection for the first time, the operating tool and the sensor must authenticate each other. After the first correct authentication, each subsequent connection is made without a new authentication query.

#### Enter Bluetooth access code

For authentication, enter the 6-digit Bluetooth access code in the next menu window. You can find the code on the outside of the device housing and on the information sheet "Pins and Codes" in the device packaging.

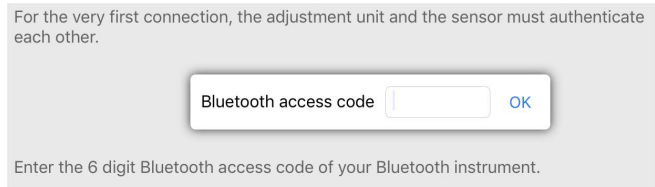

Fig. 19: Enter Bluetooth access code



#### Note:

If an incorrect code is entered, the code can only be entered again after a delay time. This time gets longer after each incorrect entry.

The message "Waiting for authentication" is displayed on the smartphone/tablet.

**Connected**

After connection, the sensor adjustment menu is displayed on the respective adjustment tool.

If the Bluetooth connection is interrupted, e.g. due to a too large distance between the two devices, this is displayed on the adjustment tool. The message disappears when the connection is restored.

**Change device code**

Parameter adjustment of the device is only possible if the parameter protection is deactivated. When delivered, parameter protection is deactivated by default and can be activated at any time.

It is recommended to enter a personal 6-digit device code. To do this, go to menu "Extended functions", "Access protection", menu item "Protection of the parameter adjustment".

**10.3 Parameter adjustment****Enter parameters**

The sensor adjustment menu is divided into two areas, which are arranged next to each other or one below the other, depending on the adjustment tool.

- Navigation section
- Menu item display

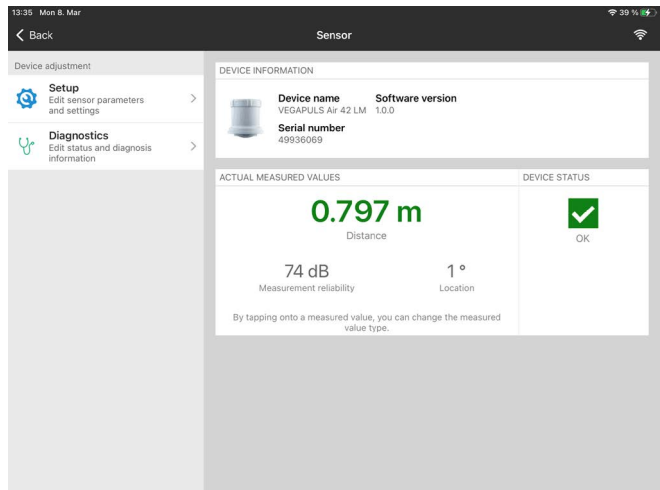

Fig. 20: Example of an app view - Device information, measured values

The selected menu item can be recognized by the colour change.

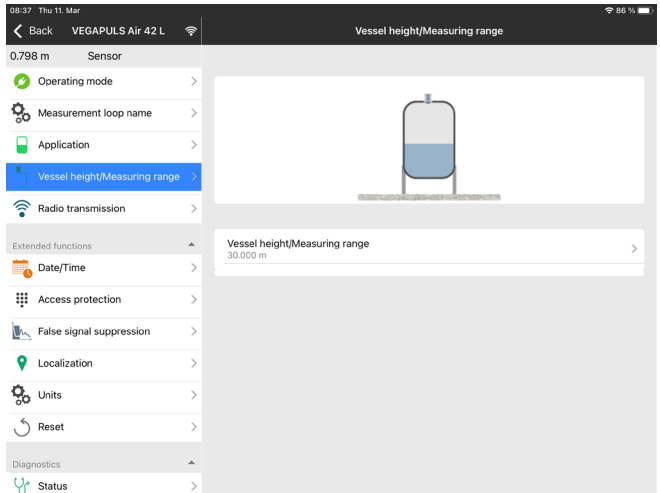

Fig. 21: Example of an app view - Menu item vessel height, measuring range

Enter the requested parameters and confirm via the keyboard or the editing field. The settings are then active in the sensor.

Close the app to terminate connection.

## 11 Setup with PC/notebook (Bluetooth)

### 11.1 Preparations

#### System requirements

Make sure that your PC/notebook meets the following system requirements:

- Operating system Windows 10 or newer
- DTM Collection 10/2020 or newer
- Bluetooth 4.0 LE or newer

#### Activate Bluetooth connection

Activate the Bluetooth connection via the project assistant.



#### Note:

Older systems do not always have an integrated Bluetooth LE. In these cases, a Bluetooth USB adapter is required. Activate the Bluetooth USB adapter using the Project Wizard.

After activating the integrated Bluetooth or the Bluetooth USB adapter, devices with Bluetooth are found and created in the project tree.

#### Device activated

Make sure that the VEGAPULS Air 41 is activated, see chapter "*Operating modus, activate device*".

### 11.2 Connecting

#### Connecting

Select the requested device for the online parameter adjustment in the project tree.

#### Authenticate

When establishing the connection for the first time, the operating tool and the device must authenticate each other. After the first correct authentication, each subsequent connection is made without a new authentication query.

#### Enter Bluetooth access code

For authentication, enter in the next menu window the 6-digit Bluetooth access code:

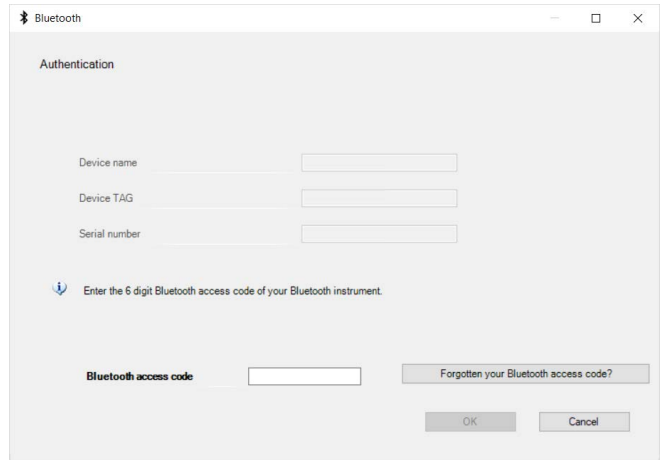

Fig. 22: Enter Bluetooth access code

You can find the code on the outside of the device housing and on the information sheet "PINs and Codes" in the device packaging.



**Note:**

If an incorrect code is entered, the code can only be entered again after a delay time. This time gets longer after each incorrect entry.

The message "Waiting for authentication" is displayed on the PC/notebook.

**Connected**

After connection, the device DTM appears.

If the connection is interrupted, e.g. due to a too large distance between device and adjustment tool, this is displayed on the adjustment tool. The message disappears when the connection is restored.

**Change device code**

Parameter adjustment of the device is only possible if the parameter protection is deactivated. When delivered, parameter protection is deactivated by default and can be activated at any time.

It is recommended to enter a personal 6-digit device code. To do this, go to menu "Extended functions", "Access protection", menu item "Protection of the parameter adjustment".

**11.3 Parameter adjustment**

**Prerequisites**

For parameter adjustment of the instrument via a Windows PC, the configuration software PACTware and a suitable instrument driver (DTM) according to FDT standard are required. The latest PACTware version as well as all available DTMs are compiled in a DTM Collection. The DTMs can also be integrated into other frame applications according to FDT standard.

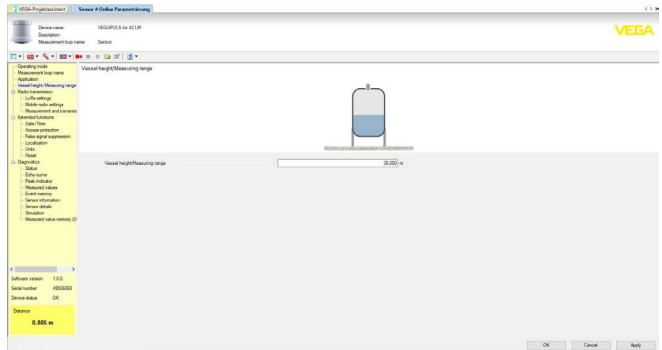

Fig. 23: Example of a DTM view - Menu item vessel height, measuring range

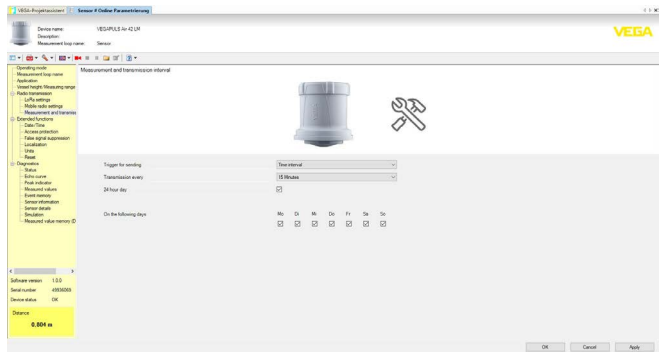
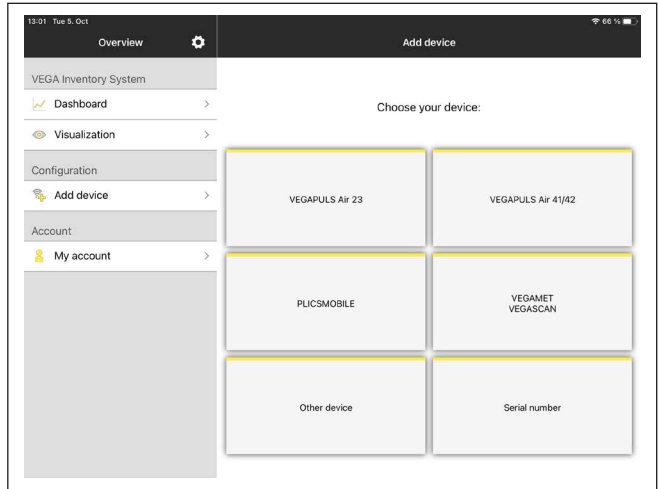

Fig. 24: Example of a DTM view - Menu item measurement and transmission interval

## 12 Set up measuring point via the VEGA Inventory System app

### Select device

First select the device you want to add to the VEGA Inventory System:



### Select method for adding

Select the desired method for adding:

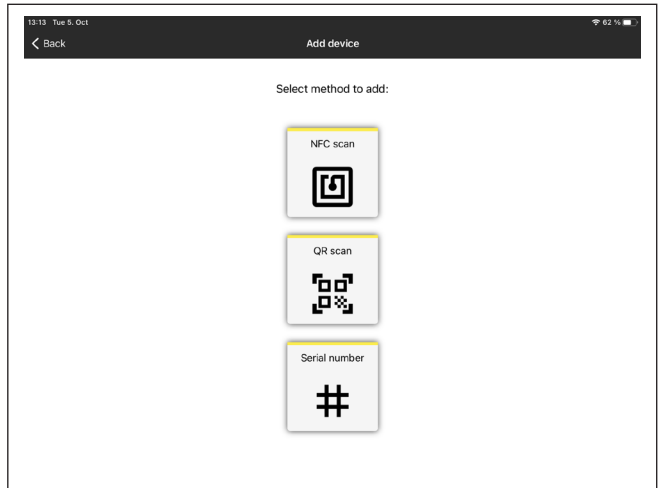

### Configure device

The device configuration comprises measuring point, adjustment/linearization as well as user-defined fields:

The screenshot shows the 'Device configuration' screen for 'VEGAPULS Air 23'. It is divided into three main sections:

- Measuring Point:** Contains fields for 'Tank name' (VEGAPULS Air 23), 'Product' (None), 'Groups' (None), and 'Location' (Schiltach, Am Höhenstein 113).
- Adjustment / Linearization:** A section with a right-pointing arrow and a 'New' button at the bottom right.
- User-defined fields:** Contains fields for 'SAP-No.' and 'Testfeld'.

### Adjust device

Via the min./max. adjustment you determine which distance values of the sensor correspond to 0 % and 100 % of your measurement:

The screenshot shows the 'Adjustment / Linearization' screen. At the top, there is a diagram of a tank with a sensor. The diagram labels 'Max. adjustment' and 'Min. adjustment' with arrows pointing to the top and bottom of the tank respectively. It also shows 'Sensor reference plane', 'Distance A' (from the reference plane to the top), and 'Distance B' (from the reference plane to the bottom).

Below the diagram are the following input fields:

- Name:** VEGAPULS Air 23 - VEGAPULS Air 23
- Max. adjustment in %:** 100
- Distance A:** [Empty field] m
- Min. adjustment in %:** 0
- Distance B:** [Empty field] m
- Scaling:**
  - 0%:** 0
  - 100%:** 0
  - Unit:** [Empty field]

### 13 Operate device via VEGA Inventory System

**Overview**

The VEGA Inventory System offers the possibility of remote access via cellular radio to the VEGAPULS Air 41.

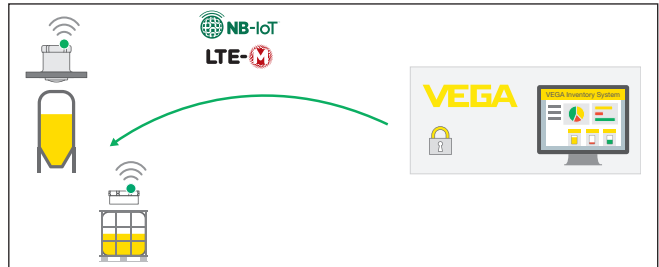

Fig. 25: Remote access from VEGA Inventory System via NB-IoT or LTE-M to the sensor



**Note:**

This remote access is not supported when connecting via LoRaWAN.

**Prerequisites**

Prerequisites for the use of this feedback channel are:

- Device software from 1.1.0<sup>1)</sup>
- Current version of the VEGA Inventory Systems
- Available mobile connection via NB-IoT/LTE-M

**Access scope**

Readable parameters:

- IMEI<sup>2)</sup>

Modifiable parameters:

- Vessel height/Operating range
- Measuring and transmission interval
- Event-controlled measurement and transmission interval

Triggerable actions:

- Location determination (request location)
- Plan maintenance

The changes are first stored in the VEGA Inventory System. They are transferred to the sensor with the next cyclical measured value transmission and are then effective.



**Note:**

If parameterization protection is activated in the sensor, this remote access is not available.

<sup>1)</sup> Devices with this software version or higher have a suitable mobile radio chip. A software update to this version is not possible.

<sup>2)</sup> International Mobile Equipment Identity

## 14 Menu overview

### Basic functions

Menu item	Parameter	Selection	Basic settings
Operating mode		Activated, deactivated	Deactivated
Measurement loop name	-	-	Sensor
Application	Medium	Liquid, bulk solid	Bulk solid
Vessel height/Operating range	Vessel height/Operating range	0 ... 15,000 m	15,000 m

### Radio transmission

Menu item	Parameter	Selection	Basic settings
	Transmission mode	LoRa Mobile radio + LoRa Mobile network	Mobile radio + LoRa
	Country of use	Country list	Germany
	Transmit current measured value	Execute	-
LoRa settings	Band	EU868, EU863-870, US915, US902-928, AS923, AS923-1, AU915-928, IN865- 867, KR920-923	Basic setting depending on the country of use
	Device EUI	-	-
	Join EUI	0030870000000001	0030870000000001
	APP Key	-	-
	Join	Execute	-
	Adaptive Data Rate (ADR)	Activated, deactivated	Activated
Mobile radio settings	LTE Mode	NB-IoT, LTE Cat-M1, Automatically	Automatically
	COAP settings	Host Name	data-vis.vega.com
		Port	5684
		URI	data
Measuring and transmission interval	Trigger for dispatch	Time, time interval	Time
	Transmission takes place at/every	15 min, 30 min, 1 h, 2 h, 3 h, 4 h, 6 h, 12 h	6 h
	All day		
	On the weekdays	Monday, Tuesday, Wednesday, Thursday, Friday, Saturday, Sunday	Monday, Tuesday, Wednesday, Thursday, Friday, Saturday, Sunday

Menu item	Parameter	Selection	Basic settings
Event-controlled	Event measurement	Activated, deactivated With "activated" the following parameters are released	Deactivated
	Condition	≥ (greater than/equal to) ≤ (less than/equal to)	≤
	Distance to the level		0.000 m
	Measurement/transmission takes place every	10 min, 15 min, 30 min, 1 h, 2 h, 3 h, 4 h, 6 h, 8 h, 12 h	1 h

## Extended functions

Menu item	Parameter	Selection	Basic settings
Date/Time	Date	According to calendar	From integrated clock
	Format	12 h, 24 h	24 h
	Time	-	From integrated clock
	Weekday	Monday, Tuesday, Wednesday, Thursday, Friday, Saturday, Sunday	
	Accept PC system time	-	-
	Write data into device	-	-
Access protection	Bluetooth access code	-	-
	Protection of the parameterization	Activated, deactivated	Deactivated
	Network access code	-	
False signal suppression	False signal suppression	Create new, expand, delete all	-
	Sounded distance to the medium from the sealing surface	0 ... m (vessel height/operating range)	-
Localization	GPS	On, Off	Off
Units	Distance unit of the device	mm, m, in, ft	mm
	Temperature unit of the instrument	°C, °F, K	°C
Reset	Reset	Restore basic settings	-

Menu item	Parameter	Selection	Basic settings
Mode of operation	Mode of operation	Mode 1: EU, Albania, Andorra, Australia, Belarus, Bosnia and Herzegovina, Canada, Liechtenstein, Moldova, Monaco, Montenegro, New Zealand, Northern Macedonia, Norway, San Marino, Saudi Arabia, Serbia, Switzerland, Turkey, United Kingdom, USA Mode 2: Brazil, South Korea, Thailand, South Africa Mode of operation 3: India, Malaysia Mode 4: No country approvals	Mode of operation 1
Special parameters	-	-	

## Diagnostics

Menu item	Parameter	Selection/Display	Basic settings
Status	Device status	Device status, detail status	-
	Change counter	-	-
	Measured value status	Distance, measurement reliability	-
	Status additional measured values	Electronics temperature	-
	Battery status	-	-
	Location	Latitude, Longitude, Date/Time	Last detected position
	Location	Location in degrees	-
	Mobile radio information	Signal strength, SIM card (ICCID), IP address, cellular band, mobile radio information	-
Echo curve	Indication of echo curve	-	-
Peak indicator	Peak indicator, distance	Min. distance, date/time min. distance, max. distance, date/time distance, date/time max. distance	-
	Peak indicator, measurement reliability	Min. measurement reliability, date/time min. measurement reliability, max. measurement reliability, date/time max. measurement reliability	-
	Peak indicator, electronic temperature	Min. electronics temperature, date/time min. electronics temperature, max. electronics temperature, date/time max. electronics temperature	-
		Reset peak indicator	-

Menu item	Parameter	Selection/Display	Basic settings
Measured values	Measured values	Distance, measurement reliability	Actual values
	Additional measured values	Position, electronics temperature, measuring rate	
Event memory	List of the parameter changes and events in the device	Date, time, status, event type, event description, value/extended status	-
Sensor information	Device name, serial number, hardware/software version, factory calibration date, software version cellular radio, software version cellular modem	-	-
Sensor characteristics	Special features of the instrument	-	-
Simulation	Measured value	Distance	-
	Simulation value	Start/finish simulation	-
Measured value memory (DTM)	Display distance from measured value memory	-	-

## 15 Diagnostics and servicing

### 15.1 Maintenance

#### Maintenance

If the device is used properly, no special maintenance is required in normal operation.

#### Precaution measures against buildup

In some applications, buildup on the antenna system can influence the measuring result. Depending on the sensor and application, take measures to avoid heavy soiling of the antenna system. If necessary, clean the antenna system in certain intervals.

#### Cleaning

The cleaning helps that the type label and markings on the instrument are visible.

Take note of the following:

- Use only cleaning agents which do not corrode the housings, type label and seals
- Use only cleaning methods corresponding to the housing protection rating

### 15.2 Rectify faults

#### Reaction when malfunction occurs

The operator of the system is responsible for taking suitable measures to rectify faults.

#### Causes of malfunction

The device offers maximum reliability. Nevertheless, faults can occur during operation. These may be caused by the following, e.g.:

- Sensor
- Process
- Battery charge status
- Availability/quality of radio transmission
- Signal processing

#### Fault rectification

The first measures are:

- Evaluation of fault messages
- Checking the output signal
- Checking the radio quality or availability of the radio standard
- Treatment of measurement errors

A smartphone/tablet with the adjustment app or a PC/notebook with the software PACTware and the suitable DTM offer you further comprehensive diagnostic possibilities. In many cases, the causes can be determined in this way and the faults eliminated.

#### Reaction after fault rectification

Depending on the reason for the fault and the measures taken, the steps described in chapter "Setup" must be carried out again or must be checked for plausibility and completeness.

#### 24 hour service hotline

Should these measures not be successful, please call in urgent cases the VEGA service hotline under the phone no. **+49 1805 858550**.

The hotline is also available outside normal working hours, seven days a week around the clock.

Since we offer this service worldwide, the support is provided in English. The service itself is free of charge, the only costs involved are the normal call charges.

### 15.3 Status messages according to NE 107

The instrument features self-monitoring and diagnostics according to NE 107 and VDI/VDE 2650. In addition to the status messages in the following tables there are more detailed error messages available under the menu item "Diagnostics" via the respective adjustment module.

#### Status messages

The status messages are divided into the following categories:

- Failure
- Function check
- Out of specification
- Maintenance required

and explained by pictographs:

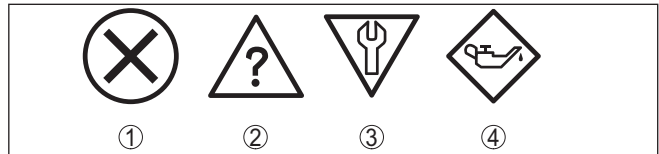

Fig. 26: Pictographs of the status messages

- 1 Failure - red
- 2 Out of specification - yellow
- 3 Function check - orange
- 4 Maintenance required - blue

#### **Malfunction (Failure):**

Due to a malfunction in the instrument, a fault signal is output.

This status message is always active. It cannot be deactivated by the user.

#### **Function check:**

The instrument is being worked on, the measured value is temporarily invalid (for example during simulation).

This status message is inactive by default.

#### **Out of specification:**

The measured value is unreliable because an instrument specification was exceeded (e.g. electronics temperature).

This status message is inactive by default.

#### **Maintenance required:**

Due to external influences, the instrument function is limited. The measurement is affected, but the measured value is still valid. Plan in maintenance for the instrument because a failure is expected in the near future (e.g. due to buildup).

This status message is inactive by default.

## Failure

Code Text message	Message detail status	Cause	Rectification
F013 no measured value available	22000, 22100, 32100	No measured value in the switch-on phase or during operation Sensor tilted	Check or correct installation and/or parameter settings Clean the antenna system
F017 Adjustment span too small	4001	Adjustment not within specification	Change adjustment according to the limit values (difference between min. and max. $\geq 10$ mm)
F025 Error in the linearization table	4002	Index markers are not continuously rising, for example illogical value pairs	Check linearization table Delete table/Create new
F036 No operable software	16014	Checksum error if software update failed or aborted	Repeat software update Send instrument for repair
F040 Error in the electronics	1016, 5001, 12008	Limit value exceeded in signal processing Hardware error	Restart instrument Send instrument for repair
F080 General software error	7002, 12200, 12201, 12204 ... 12207, 14000, 14001, 16010	General software error	Restart instrument
F105 Determine measured value	22001	The instrument is still in the switch-on phase, the measured value could not yet be determined	Wait for the end of the switch-on phase Duration up to 3 minutes depending on the measurement environment and parameter settings
F260 Error in the calibration	12001, 12003, 12005, 12014, 12016, 12026, 22002, 22003, 24000 ... 24003	Checksum error in the calibration values Error in the EEPROM	Send instrument for repair
F261 Error in the instrument settings	4004, 6256, 12000, 12002, 12004, 12010 ... 12013, 12015, 12017, 12022, 24100 ... 24103, 24200 ... 24203, 26000 ... 26003 26100 ... 26103	Error during setup False signal suppression faulty Error when carrying out a reset	Repeat setup Carry out a reset
F265 Measurement function disturbed	16001, 16002	Program sequence of the measuring function disturbed	Device restarts automatically

**Function check**

Code Text message	Message detail status	Cause	Rectification
C700 Simulation active	4005 ... 4008, 4018	A simulation is active	Finish simulation Wait for the automatic end after 60 mins.

**Out of specification**

Code Text message	Message detail status	Cause	Rectification
S600 Impermissible electronics temperature	4078	Temperature of the electronics in the non-specified range	Check ambient temperature Insulate electronics
S601 Overfilling	22105	Danger of vessel overfilling	Make sure that there is no further filling Check level in the vessel
S603 Impermissible operating voltage	16009	Battery voltage too low	Check battery voltage

**Maintenance**

Code Text message	Message detail status	Cause	Rectification
M500 Error in the delivery status	12009	The data could not be restored during the reset to delivery status	Repeat reset Load XML file with sensor data into the sensor
M501 Error in the delivery status	4003	Hardware error EEPROM	Send instrument for repair
M504 Error at a device interface	31200 ... 31204	Hardware error EEPROM	Send instrument for repair
M507 Error in the instrument settings	12020 ... 12025	Error during setup Error when carrying out a reset False signal suppression faulty	Carry out reset and repeat setup
M508 No executable Bluetooth software	27002	Checksum error in Bluetooth software	Carry out software update
M509 Software update running	30000	Software update running	Wait until software update is finished

**15.4 Treatment of measurement errors**

The tables below give typical examples of application-related measurement errors.

The images in column "Error description" show the actual level as a dashed line and the output level as a solid line.

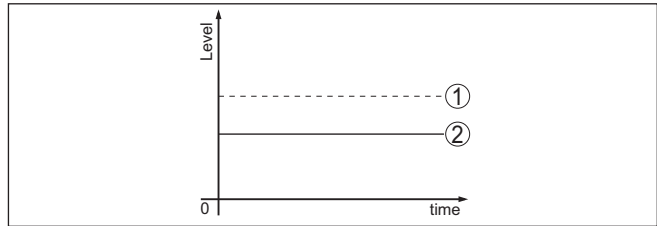

- 1 Real level
- 2 Level displayed by the sensor

**Liquids: Measurement error at constant level**

Fault description	Cause	Rectification
Measured value shows a too low or too high level 	Min./max. adjustment not correct	Adapt min./max. adjustment
	Incorrect linearization curve	Adapt linearization curve
Measured value jumps towards 100 % 	Due to the process, the amplitude of the level echo sinks A false signal suppression was not carried out	Carry out a false signal suppression
	Amplitude or position of a false signal has changed (e.g. condensation, build-up); false signal suppression no longer matches actual conditions	Determine the reason for the changed false signals, carry out false signal suppression, e.g. with condensation.

**Liquids: Measurement error during filling**

Fault description	Cause	Rectification
Measured value remains unchanged during filling 	False signals in the close range too big or level echo too small Strong foam or vortex generation Max. adjustment not correct	Eliminate false signals in the close range Check measuring point: Antenna should protrude out of the threaded mounting socket, possible false echoes through flange socket? Remove contamination on the antenna In case of interferences due to installations in the close range, change polarisation direction Create a new false signal suppression Adapt max. adjustment

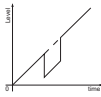
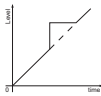
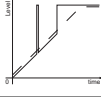
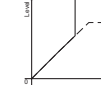
Fault description	Cause	Rectification
Measured value jumps towards 0 % during filling 	The level echo cannot be distinguished from the false signal at a false signal position (jumps to multiple echo)	In case of interferences due to installations in the close range: Change polarisation direction Chose a more suitable installation position
Measured value jumps towards 100 % during filling 	Due to strong turbulence and foam generation during filling, the amplitude of the level echo sinks. Measured value jumps to false signal	Carry out a false signal suppression
Measured value jumps sporadically to 100 % during filling 	Varying condensation or contamination on the antenna	Carry out a false signal suppression or increase false signal suppression with condensation/contamination in the close range by editing
Measured value jumps to $\geq 100\%$ or 0 m distance 	Level echo is no longer detected in the close range due to foam generation or false signals in the close range. The sensor goes into overflow protection mode. The max. level (0 m distance) as well as the status message "Overflow protection" are output.	Check measuring point: Antenna should protrude out of the threaded mounting socket, possible false echoes through flange socket? Remove contamination on the antenna

**Liquids: Measurement error during emptying**

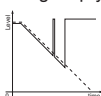
Fault description	Cause	Rectification
Measured value remains unchanged in the close range during emptying 	False signal larger than the level echo Level echo too small	Check measuring point: Antenna should protrude out of the threaded mounting socket, possible false echoes through flange socket? Remove contamination on the antenna In case of interferences due to installations in the close range: Change polarisation direction After eliminating the false signals, the false signal suppression must be deleted. Carry out a new false signal suppression
Measured value jumps sporadically towards 100 % during emptying 	Varying condensation or contamination on the antenna	Carry out false signal suppression or increase false signal suppression in the close range by editing With bulk solids, use radar sensor with purging air connection

64808-EN-250626

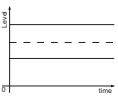
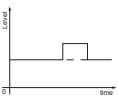

**Bulk solids: Measurement error at constant level**

Fault description	Cause	Rectification
Measured value shows a too low or too high level 	Min./max. adjustment not correct	Adapt min./max. adjustment
	Incorrect linearization curve	Adapt linearization curve
Measured value jumps towards 100 % 	Due to the process, the amplitude of the product echo decreases A false signal suppression was not carried out	Carry out a false signal suppression
	Amplitude or position of a false signal has changed (e.g. condensation, build-up); false signal suppression no longer matches actual conditions	Determine the reason for the changed false signals, carry out false signal suppression, e.g. with condensation.

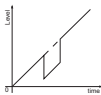
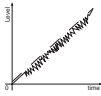
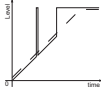
**Bulk solids: Measurement error during filling**

Fault description	Cause	Rectification
Measured value jumps towards 0 % during filling 	The level echo cannot be distinguished from the false signal at a false signal position (jumps to multiple echo)	Remove/reduce false signal: minimize interfering installations by changing the polarization direction Chose a more suitable installation position
	Transverse reflection from an extraction funnel, amplitude of the transverse reflection larger than the level echo	Direct sensor to the opposite funnel wall, avoid crossing with the filling stream
Measured value fluctuates around 10 ... 20 % 	Various echoes from an uneven medium surface, e.g. a material cone	Check parameter "Material Type" and adapt, if necessary Optimize installation position and sensor orientation
	Reflections from the medium surface via the vessel wall (deflection)	Select a more suitable installation position, optimize sensor orientation, e.g. with a swivelling holder
Measured value jumps sporadically to 100 % during filling 	Changing condensation or contamination on the antenna	Carry out a false signal suppression or increase false signal suppression with condensation/contamination in the close range by editing

**Bulk solids: Measurement error during emptying**

Fault description	Cause	Rectification
<p>Measured value remains unchanged in the close range during emptying</p> 	<p>False signal greater than level echo or level echo too small</p>	<p>Eliminate false signals in the close range. Check: Antenna must protrude out of the nozzle</p> <p>Remove contamination on the antenna</p> <p>Minimize interfering installations in the close range by changing the polarization direction</p> <p>After eliminating the false signals, the false signal suppression must be deleted. Carry out a new false signal suppression</p>
<p>Measured value jumps sporadically towards 100 % during emptying</p> 	<p>Changing condensation or contamination on the antenna</p>	<p>Carry out false signal suppression or increase false signal suppression in the close range by editing</p>
<p>Measured value fluctuates around 10 ... 20 %</p> 	<p>Various echoes from an uneven medium surface, e.g. an extraction funnel</p> <p>Reflections from the medium surface via the vessel wall (deflection)</p>	<p>Check parameter "Material Type" and adapt, if necessary</p> <p>Optimize installation position and sensor orientation</p>

**15.5 Exchange battery**



**Only** new batteries of the specified battery type and battery manufacturer (see chapter "Technical Data") may be used if the VEGAPULS Air 41 requires one of the following approvals:

Ex-approval for use in areas with an explosion risk

"Ordinary Location"-approval for use in North America or Canada

On all other applications, batteries may be used which have the same technical data and comply with the standards IEC 60086-4 and UL1642.

**Preparation**

The battery should be exchanged in the following cases:

- Low reported remaining battery life
- Device can no longer be activated



**Note:**

All user settings in the operator menu are retained, i.e. an activated sensor remains activated.

Only use new batteries of the specified battery type and battery manufacturer.

**Battery exchange**

Proceed as follows when carrying out the exchange:

1. Unscrew the housing lid
2. Remove the old battery with the help of the fabric tape
3. Leave the device without power, i. e. without batteries, for at least 2 minutes
4. Insert new battery, observe  $\pm$ -polarity at the bottom of the battery holder
5. Screw on housing cover
6. Reset internal clock with the operating tool

This completes the battery replacement, the capacity is reset automatically to 100 % for adjustment app and DTM.

## 15.6 Software update

The following components are required for an update of the instrument software:

- Instrument
- PC with PACTware/DTM and Bluetooth USB adapter
- Current instrument software as file

You can find the current instrument software as well as detailed information on the procedure in the download area of our homepage: [www.vega.com](http://www.vega.com).



### Caution:

Instruments with approvals can be bound to certain software versions. Therefore make sure that the approval is still effective after a software update is carried out.

You can find detailed information in the download area at [www.vega.com](http://www.vega.com).

## 15.7 Security Update

If an IT security vulnerability has been identified on a device or device series, VEGA actively approaches affected customers and informs them of the necessary security measures and how to proceed. In addition, corresponding notifications are published on the usual platforms such as CERT@VDE.

If you have any questions, please get in touch with your personal contact. Have the serial number of your device available.

## 15.8 How to proceed if a repair is necessary

On our homepage you will find detailed information on how to proceed in the event of a repair.

So that we can carry out the repair quickly and without queries, generate a instrument return form there with the data of your device.

The following is required:

- The serial number of the instrument
- A short description of the fault
- Details of the medium, if applicable

Print the generated instrument return form.

Clean the instrument and pack it damage-proof.

Send the printed instrument return form and possibly a safety data sheet together with the device.

You will find the address for the return on the generated instrument return form.

## 16 Dismount

### 16.1 Dismounting steps

To remove the device, carry out the steps in chapters "*Mounting*" and "*Connecting to power supply*" in reverse.



**Warning:**

When dismantling, pay attention to the process conditions in vessels or pipelines. There is a risk of injury, e.g. due to high pressures or temperatures as well as aggressive or toxic media. Avoid this by taking appropriate protective measures.

### 16.2 Disposal



Pass the instrument on to a specialised recycling company and do not use the municipal collecting points.

Remove any batteries in advance, if they can be removed from the device, and dispose of them separately.

If personal data is stored on the old device to be disposed of, delete it before disposal.

If you have no way to dispose of the old instrument properly, please contact us concerning return and disposal.

## 17 Certificates and approvals

### 17.1 Radio licenses

#### **Radar**

The device has been tested and approved in accordance with the current edition of the applicable country-specific norms or standards.

Regulations for use can be found in the document "*Regulations for radar level measuring instruments with radio licenses*" on our homepage.

#### **Bluetooth**

The Bluetooth radio module in the device has been tested and approved according to the current edition of the applicable country-specific norms or standards.

The confirmations as well as regulations for use can be found in the document "*Radio licenses*" supplied or on our homepage.

#### **Mobile network**

The radio modules in the device have been tested and approved according to the current edition of the applicable country-specific norms or standards.

The confirmations as well as regulations for use can be found in the document "*Radio licenses*" supplied or on our homepage.

#### **LPWAN**

The radio module in the device has been tested and approved according to the current edition of the applicable country-specific norms or standards.

The confirmations as well as regulations for use can be found in the document "*Radio licenses*" supplied or on our homepage.

### 17.2 Approvals for Ex areas

Approved versions for use in hazardous areas are available or in preparation for the device or the device series.

You can find the relevant documents on our homepage.

### 17.3 Conformity

The device complies with the legal requirements of the applicable country-specific directives or technical regulations. We confirm conformity with the corresponding labelling.

The corresponding conformity declarations can be found on our homepage.

### 17.4 Environment management system

Protection of the environment is one of our most important duties. That is why we have introduced an environment management system with the goal of continuously improving company environmental protection. The environment management system is certified according to DIN EN ISO 14001.

Help us to meet these requirements and observe the environmental instructions in the chapters "*Packaging, transport and storage*", "*Disposal*" of this instructions manual.

## 18 Supplement

### 18.1 Technical data

#### Note for approved instruments

The technical data in the respective safety instructions which are included in delivery are valid for approved instruments (e.g. with Ex approval). These data can differ from the data listed herein, for example regarding the process conditions or the voltage supply.

All approval documents can be downloaded from our homepage.

#### Materials and weights

##### Materials, wetted parts

- Thread	PVDF
- Process seal	FKM (G type threaded connections only)
- Antenna lens	PVDF

##### Materials, non-wetted parts

- Housing	PVDF
Instrument weight, depending on process fitting	0.7 ... 3.4 kg (1.543 ... 7.496 lbs)
Process fitting	Thread G1½, R1½, 1½ NPT

#### Torques

Torque counter nut max.	7 Nm (5.163 lbf ft)
-------------------------	---------------------

#### Input variable

Measured variable	The measured quantity is the distance between the end of the sensor antenna and the medium surface. The reference plane for the measurement is the sealing face at the bottom of the hexagon.
-------------------	---

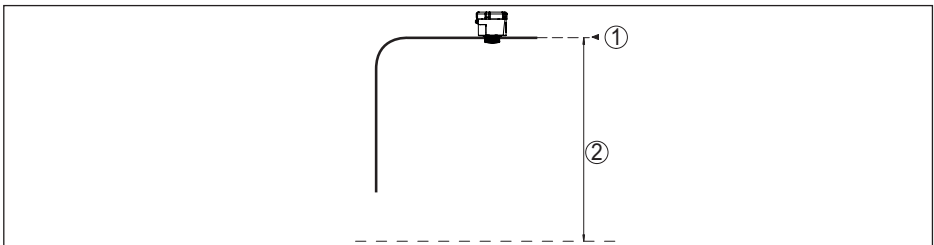

Fig. 27: Data of the input variable

- 1 Reference plane
- 2 Measured variable, max. measuring range

Max. measuring range	15 m (49.21 ft)
Recommended measuring range <sup>3)</sup>	up to 10 m (32.81 ft)

<sup>3)</sup> With bulk solids



– Max. spectral transmission power density	+34 dBm/50 MHz EIRP
– Max. power density at a distance of 1 m	< 3 μW/cm <sup>2</sup>
Alignment for measurement	vertical 90°, ± 10°

---

**Switch-on phase**

---

Start-up time to the first valid measured value	< 10 s
---	--------

---

**Wireless data transmission - mobile radio**

---

Frequency bands<sup>7)</sup>

– NB-IoT (LTE-Cat-NB1)	B1, B2, B3, B4, B5, B6, B8, B12, B13, B17, B19, B20, B25, B26, B28, B66
– LTE-M (LTE-CAT-M1)	B1, B2, B3, B4, B5, B6, B8, B12, B13, B14, B17, B18, B19, B20, B25, B26, B28, B66

---

**Wireless data transmission - LoRaWAN**

---

LoRaWAN region	EU863-870, US902-928, AU915-928, AS923-1, IN865-867, KR920-923
----------------	--

Max. emitted power

– EU863-870	14 dBm
– US902-928	14 dBm
– AU915-928	14 dBm
– AS923-1	16 dBm
– IN865-867	20 dBm
– KR920-923	14 dBm

LoRaWAN Specification Version	V1.0.2
-------------------------------	--------

LoRaWAN Regional Parameters Version	1.0.2rB
-------------------------------------	---------

Class of Operation	A
--------------------	---

Optional ADR Feature Supported	Yes
--------------------------------	-----

Activation	OTAA
------------	------

---

**Bluetooth interface**

---

Bluetooth standard	Bluetooth 5.0
Frequency	2.402 ... 2.480 GHz
Max. emitted power	+2.7 dbm EIRP
Max. number of participants	1
Effective range typ. <sup>8)</sup>	25 m (82 ft)

<sup>7)</sup> Delivery country-specific according to order configuration

<sup>8)</sup> Depending on the local conditions

**Ambient conditions**

Ambient temperature	-20 ... +60 °C (-4 ... +140 °F)
Storage and transport temperature	-20 ... +60 °C (-4 ... +140 °F)

**Mechanical environmental conditions**

Vibrations (oscillations)	Class 4M8 acc. to IEC 60721-3-4 (5 g, 4 ... 200 Hz)
Impacts (mechanical shock)	Class 6M4 acc. to IEC 60721-3-6 (50 g; 2.3 ms)
Impact resistance	IK07 acc. to IEC 62262

**Process conditions**

For the process conditions, please also note the specifications on the type label. The lowest value (amount) always applies.

Process temperature	-20 ... +60 °C (-4 ... +140 °F)
Process pressure	-1 ... 2 bar (-100 ... 200 kPa/-14.5 ... 29.01 psig)

**Integrated clock**

Date format	Day.Month.Year
Time format	12 h/24 h
Time zone, factory setting	CET
Max. rate deviation	10.5 min/year

**Battery**

Type	LS 33600 (Saft), Mono (D), Lithium metal (Li/SOCL <sub>2</sub> ), not rechargeable
Number of batteries	1
Voltage	3.6 V
Capacitance	17.0 Ah
Energy content	61.2 Wh
Lithium concentration	approx. 4.5 g
Weight	90 g
Self-discharge	< 1 % after 1 year at 20 °C
Running time	

The battery runtime depends on many factors: Reception quality, measurement conditions, temperature fluctuations, radio standard, network provider, ...

Typical measurement tasks under average conditions deliver battery runtimes of over eight years.

The battery runtime calculator provides a detailed calculation with adjustable measurement conditions: [www.vega.com/en-de/products/product-catalog/level/radar/vegapuls-air-runtime-calculation](http://www.vega.com/en-de/products/product-catalog/level/radar/vegapuls-air-runtime-calculation)

**Additional output parameter - Electronics temperature**

Range	-20 ... +60 °C (-4 ... +140 °F)
Resolution	< 0.1 K
Deviation	±3 K

**Electrical protective measures**

Protection rating	IP66/IP68 (IPX8: 0.2 bar for 24 hr) acc. to IEC 60529, Type 6P acc. to NEMA
Altitude above sea level	2000 m (6562 ft)
Protection class	None (autarcic operation)
Overvoltage category	None (autarcic operation)
Pollution degree	4

**18.2 Radio networks LTE-M and NB-IoT**

**LTE-M and NB-IoT**

LTE-M (Long Term Evolution for Machines) and NB-IoT (Narrowband Internet of Things) are extensions of the LTE mobile radio standard to IoT applications. Both enable the wireless connection of mobile, physical objects to the Internet via the mobile network.

You can find more information about the respective mobile phone provider.

**18.3 Radio networks LoRaWAN - Data transmission**

**LoRaWAN**

LoRaWAN (Long Range Wide Area Network) is a network protocol for wireless signal transmission to a corresponding gateway. LoRaWAN enables a range of several kilometres outdoors and good building penetration with low power consumption of the transmission module.

*FPort 1* is used for the uplink of the LoRa data packets.

In the following, the necessary device-specific details are shown. You can find further information of LoRaWAN on [www.lora-alliance.org](http://www.lora-alliance.org).

**Data stream, byte order, packet structure**

The data are transferred as a byte stream in packets. Each packet is given an identifier at the beginning which defines the meaning of the following bytes.

Byte sequence according to:

Cayenne Low Power Payload (LPP) Guideline, BigEndian.

Packet 8 is transferred as standard. Alternative packets are required if additional characteristic values (error status, position) occur in the sensor. The maximum packet size is 52 bytes in Europe and 11 bytes in the USA with maximum spread factor.

A LoRa standard function additionally transmits a packet counter and the serial number of the LoRa module with every packet.

**Packet structure**

Packet group	Physical measured value				Measured value set				Information	
	OK	OK & GPS	Error	Error & GPS	OK	OK & GPS	Error	Error & GPS	Info1	Info2
Packet	8	9	10	11	12	13	14	15	16	17
	Number of bytes									
Packet identifier	1	1	1	1	1	1	1	1	1	1

64808-EN-250626

Packet group	Physical measured value				Measured value set				Information	
	OK	OK & GPS	Error	Error & GPS	OK	OK & GPS	Error	Error & GPS	Info1	Info2
<b>Packet</b>	<b>8</b>	<b>9</b>	<b>10</b>	<b>11</b>	<b>12</b>	<b>13</b>	<b>14</b>	<b>15</b>	<b>16</b>	<b>17</b>
	<b>Number of bytes</b>									
NAMUR status of the device			1	1			1	1		
Measured value as floating point number	4	4	4	4	4	4	4	4		
Unit measured value	1	1	1	1	1	1	1	1		
Measured value percent					2	2	2	2		
Measured value linearized percent					2	2	2	2		
Measured value scaled					4	4	4	4		
Unit measured value scaled					1	1	1	1		
Remaining capacity of the battery in %	1	1	1	1	1	1	1	1		
Location (GPS)		8		8		8		8		
VEGA Device status			4	4			4	4		
Temperature	2	2	2	2	2	2	2	2		
Unit temperature	1	1	1	1	1	1	1	1		
Angle of inclination to the perpendicular	1	1	1	1	1	1	1	1		
Information									1	
DTM ID									4	
Manufacturer code									4	
Device Type									4	
Software version System									1	
Software version Function									1	
Software version Error									1	
Software version Customer									1	
Measurement/transmission interval									7	
Change counter									2	
Scaling min.									4	
Scaling max.									4	
Device Name										19
Device Tag										19
<b>Total</b>	<b>11</b>	<b>19</b>	<b>16</b>	<b>24</b>	<b>20</b>	<b>28</b>	<b>25</b>	<b>33</b>	<b>35</b>	<b>39</b>

**Packet structure US SF10**

	OK	Er- ror 1	Error 2	GPS	Measured values	Info1	Info2	Info3	Info4
Packet	18	19	20	21	22	23	24	25	26
	<b>Number of bytes</b>								
Packet identifier	1	1	1	1	1	1	1	1	1
NAMUR status of the device		1	1	1	1	1	1	1	1
Measured value as floating point number	4	4							
Unit measured value	1	1							
Measured value percent					2				
Measured value linearized percent					2				
Measured value scaled					4				
Unit measured value scaled					1				
Remaining capacity of the battery in %	1	1							
Location (GPS)				8					
VEGA Device status			4						
Temperature	2		2						
Unit temperature	1		1						
Angle of inclination to the perpendicular	1	1							
Information						1			
DTM ID						4			
Manufacturer code						4			
Device Type							4		
Software version System							1		
Software version Function							1		
Software version Error							1		
Software version Customer							1		
Measurement/transmission interval								7	
Change counter								2	
Scaling min.									4
Scaling max.									4
Device Name									
Device Tag									
<b>Total</b>	<b>11</b>	<b>9</b>	<b>9</b>	<b>10</b>	<b>11</b>	<b>11</b>	<b>10</b>	<b>11</b>	<b>10</b>

**NAMUR status**

	NAMUR status				
Message NAMUR status	0	1	2	3	4
Meaning	Good	Function Check	Maintenance request	Out of specification	Failure

**VEGA Device status**

	VEGA Device status	
Message VEGA device status	1016 ...	... 32100
Meaning	see "Message detail status" in chapter "Status messages acc. to NAMUR NE 107"	

**Unit measured value**

Value	0x2C = 44	0x2D = 45	0x2F = 47	0x31 = 49
Meaning	ft	m	inch	mm

**Unit temperature**

Value	0x20 = 32	0x21 = 33
Meaning	°C	°F

**Example data transmission****Packet 8, data record 0x083FA31F152D2401042009**

Byte 1	Byte 2 ... 5	Byte 6	Byte 7	Byte 8 ... 9	Byte 10	Byte 11
0x08	0x3FA31F15	0x2D	0x24	0x0104	0x20	0x09
Packet identifier	Measured value	Unit measured value	Remaining capacity of the battery in %	Temperature	Unit temperature	Angle of inclination to the perpendicular
8	1.27439	0x2D = 45 = m	36 %	26	0x20 = 32 = °C	9°

18.4 Dimensions

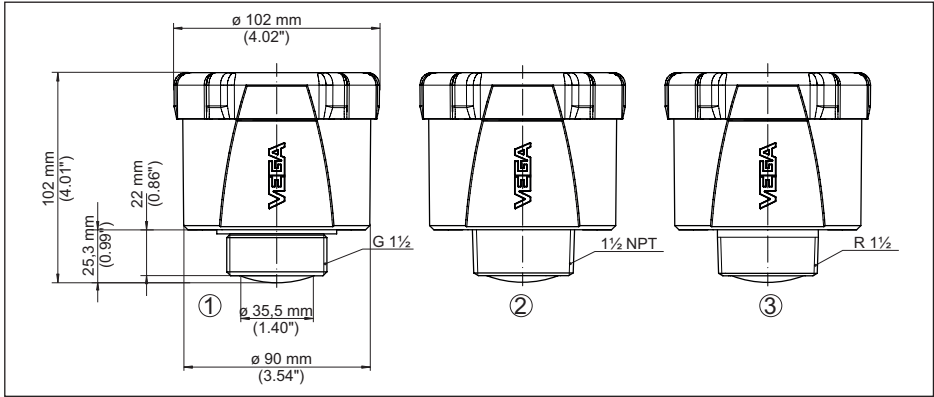

Fig. 29: Dimensions VEGAPULS Air 41

- 1 Thread G
- 2 Thread NPT
- 3 Thread R

## 18.5 Industrial property rights

VEGA product lines are global protected by industrial property rights. Further information see [www.vega.com](http://www.vega.com).

VEGA Produktfamilien sind weltweit geschützt durch gewerbliche Schutzrechte.

Nähere Informationen unter [www.vega.com](http://www.vega.com).

Les lignes de produits VEGA sont globalement protégées par des droits de propriété intellectuelle. Pour plus d'informations, on pourra se référer au site [www.vega.com](http://www.vega.com).

VEGA líneas de productos están protegidas por los derechos en el campo de la propiedad industrial. Para mayor información revise la pagina web [www.vega.com](http://www.vega.com).

Линии продукции фирмы ВЕГА защищаются по всему миру правами на интеллектуальную собственность. Дальнейшую информацию смотрите на сайте [www.vega.com](http://www.vega.com).

VEGA系列产品在全球享有知识产权保护。

进一步信息请参见网站[www.vega.com](http://www.vega.com)。

## 18.6 Licensing information for open source software

Open source software components are also used in this device. A documentation of these components with the respective license type, the associated license texts, copyright notes and disclaimers can be found on our homepage.

## 18.7 Trademark

All the brands as well as trade and company names used are property of their lawful proprietor/originator.

A large grid of graph paper for taking notes, consisting of 20 columns and 30 rows of small squares.



A large grid of graph paper for taking notes, consisting of 20 columns and 30 rows of small squares.

Printing date:

**VEGA**

All statements concerning scope of delivery, application, practical use and operating conditions of the sensors and processing systems correspond to the information available at the time of printing.

Subject to change without prior notice

© VEGA Grieshaber KG, Schiltach/Germany 2025

64808-EN-250626

VEGA Grieshaber KG  
Am Hohenstein 113  
77761 Schiltach  
Germany

Phone +49 7836 50-0  
E-mail: [info.de@vega.com](mailto:info.de@vega.com)  
[www.vega.com](http://www.vega.com)