

Operating Instructions

Radar sensor for continuous level measurement in plastic vessels

VEGAPULS Air 23

Autarkic device with measured value transmission via radio technology



Document ID: 64314



VEGA

Contents

1	About this document	4
1.1	Function	4
1.2	Target group	4
1.3	Symbols used.....	4
2	For your safety	5
2.1	Authorised personnel	5
2.2	Intended use	5
2.3	Warning about incorrect use.....	5
2.4	General safety instructions	5
2.5	Lithium cells	6
2.6	Country of use - mobile network, LoRaWan	6
2.7	Country of use - Radar signal	6
3	Product description	7
3.1	Configuration.....	7
3.2	Principle of operation.....	8
3.3	Adjustment	9
3.4	Packaging, transport and storage.....	10
3.5	Accessories.....	10
4	Mounting	11
4.1	General instructions	11
4.2	Mounting instructions	11
4.3	Mounting preparations	12
4.4	Installation procedure	13
4.5	Transportation lock after mounting	15
5	Setup - the most important steps	16
6	Onboarding	18
6.1	Onboarding on activation with VEGA Inventory System app	18
6.2	Onboarding on activation with magnet	20
7	Activate, device functions	23
7.1	Activate	23
7.2	Measurement function.....	26
7.3	Localization	27
8	Transfer measured values and data to the cloud	28
8.1	Communication basics.....	28
8.2	NB-IoT/LTE-M - VEGA Inventory System	28
8.3	LoRaWAN (Fall back) - VEGA Inventory System	29
8.4	NB-IoT/LTE-M - VEGA Cloud	29
8.5	LoRaWAN - private networks	30
9	Set up measuring point via the VEGA Inventory System app	31
10	Operate device via VEGA Inventory System	32
11	Diagnostics and servicing	33
11.1	Maintenance	33
11.2	Rectify faults.....	33
11.3	Security Update.....	34
11.4	Cell exchange	34

11.5	How to proceed if a repair is necessary.....	34
12	Removal with glue connection	35
12.1	Dismounting instructions	35
12.2	Dismounting steps mounting ring	35
12.3	Disposal	36
13	Certificates and approvals	37
13.1	Radio licenses.....	37
13.2	Approvals for Ex areas	37
13.3	Conformity.....	37
13.4	Environment management system	37
14	Supplement	38
14.1	Technical data	38
14.2	Radio networks LTE-M and NB-IoT	41
14.3	Radio networks LoRaWAN - Data transmission	42
14.4	Dimensions	45
14.5	Industrial property rights.....	46
14.6	Licensing information for open source software	46
14.7	Trademark.....	46

1 About this document

1.1 Function

This instruction provides all the information you need for mounting, connection and setup as well as important instructions for maintenance, fault rectification, safety and the exchange of parts. Please read this information before putting the instrument into operation and keep this manual accessible in the immediate vicinity of the device.

1.2 Target group

This instruction manual is directed to trained personnel. The contents of this manual must be made available to the qualified personnel and implemented.

1.3 Symbols used



Document ID

This symbol on the front page of this instruction refers to the Document ID. By entering the Document ID on www.vega.com you will reach the document download.



Information, note, tip: This symbol indicates helpful additional information and tips for successful work.



Note: This symbol indicates notes to prevent failures, malfunctions, damage to devices or plants.



Caution: Non-observance of the information marked with this symbol may result in personal injury.



Warning: Non-observance of the information marked with this symbol may result in serious or fatal personal injury.



Danger: Non-observance of the information marked with this symbol results in serious or fatal personal injury.



Ex applications

This symbol indicates special instructions for Ex applications.



List

The dot set in front indicates a list with no implied sequence.



Sequence of actions

Numbers set in front indicate successive steps in a procedure.



Disposal

This symbol indicates special instructions for disposal.

2 For your safety

2.1 Authorised personnel

All operations described in this documentation must be carried out only by trained and authorized personnel.

During work on and with the device, the required personal protective equipment must always be worn.

2.2 Intended use

The VEGAPULS Air 23 is an autarkic sensor for continuous level measurement in plastic vessels.

You can find detailed information about the area of application in chapter "*Product description*".

Operational reliability is ensured only if the instrument is properly used according to the specifications in the operating instructions manual as well as possible supplementary instructions.

2.3 Warning about incorrect use

Inappropriate or incorrect use of this product can give rise to application-specific hazards, e.g. vessel overflow through incorrect mounting or adjustment. Damage to property and persons or environmental contamination can result. Also, the protective characteristics of the instrument can be impaired.

2.4 General safety instructions

This is a state-of-the-art instrument complying with all prevailing regulations and directives. The instrument must only be operated in a technically flawless and reliable condition. The operating company is responsible for the trouble-free operation of the instrument. When measuring aggressive or corrosive media that can cause a dangerous situation if the instrument malfunctions, the operating company has to implement suitable measures to make sure the instrument is functioning properly.

The safety instructions in this operating instructions manual, the national installation standards as well as the valid safety regulations and accident prevention rules must be observed.

For safety and warranty reasons, any invasive work on the device beyond that described in the operating instructions manual may be carried out only by personnel authorised by us. Arbitrary conversions or modifications are explicitly forbidden. For safety reasons, only the accessory specified by us must be used.

To avoid any danger, the safety approval markings and safety tips on the device must also be observed.

The low transmitting power of the radar sensor as well as the integrated LTE-NB1, LTE-CAT-M1 or LoRa radio module is far below the internationally approved limits. No health impairments are to be expected with intended use. The band range of the transmission frequency can be found in chapter "*Technical data*".

2.5 Lithium cells

The power supply of the device is provided by integrated lithium cells in the housing. If the device is used as intended with the lid closed within the temperatures and pressures specified in the technical data, it is thus adequately protected.

**Note:**

Please observe the specific safety instructions in the scope of delivery of the device.

2.6 Country of use - mobile network, LoRaWan

Country or region-specific settings for transmission into the mobile radio network or LoRaWan are defined by selecting the country of use. It is absolutely essential to do this during the job-specific device configuration.

**Caution:**

Operation of the device with a false country or region of use selection can lead to malfunctions and constitutes a violation of the radio licensing regulations of the respective country or region.

2.7 Country of use - Radar signal

The device may only be used in countries or regions where it has radio approval.

**Caution:**

Operating the device in other countries or regions constitutes a violation of the regulations of the radio approvals of the respective country or region.

Further information is available in the document "*Radio licenses*" on our homepage.

The available radio approvals can also be found on our homepage.

3 Product description

3.1 Configuration

Scope of delivery

The scope of delivery encompasses:

- Radar sensor
- Integrated identification card for LTE (eSIM) (optional)
- Magnet for activation (activation via magnet is not possible with the mounting version using magnets. Therefore, no magnet for activation is enclosed with this version).
- Mounting ring with glued surface, cleaning cloth (version for glued connection)
- Tension belt (for version with flexible changeable holder)
- Information sheet "*Documents and software*" with:
 - Instrument serial number
 - QR code with link for direct scanning
- Information sheet "*PINs and Codes*" with:
 - Identifier for LoRaWAN network (Device EUI, Application EUI, App Key)

The further scope of delivery encompasses:

- Documentation
 - Safety instructions for lithium metal cell
 - If necessary, further certificates



Information:

Optional instrument features are also described in this instructions. The respective scope of delivery results from the order specification.

Versions

The radar sensor VEGAPULS Air 23 is available with different mounting techniques:

- Adhesive joint (antenna side)
- Flexibly exchangeable holder
- Ceiling mounting with screws
- Ceiling mounting with magnets

Constituent parts

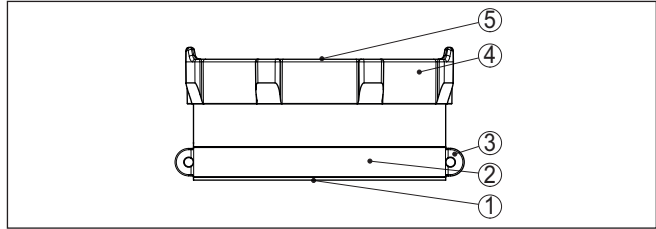

Fig. 1: Components of the VEGAPULS Air 23 sensor (example version for adhesive joint)

- 1 Radar antenna
- 2 Unscrewable mounting ring with glue surface
- 3 Eyelets for transport lock
- 4 Housing lid
- 5 Contact surface for activation by NFC or magnet

Type label

The type label contains the most important data for identification and use of the instrument:

- Instrument type
- Information about approvals
- Configuration information
- Technical data
- Serial number of the instrument
- QR code for device identification
- Manufacturer information

Documents and software

To find order data, documents or software related to your device, you have the following options:

- Move to "www.vega.com" and enter in the search field the serial number of your instrument.
- Scan the QR code on the type label.
- Open the VEGA Tools app and enter the serial number under "**Documentation**".

3.2 Principle of operation

Application area

VEGAPULS Air 23 is a radar sensor for continuous level measurement of plastic vessels, e.g. IBCs (Intermediate Bulk Container).

The device is suitable for almost all liquids.

Depending on the version, it is mounted to the vessel or to the ceiling by means of:

- Glue surface on the bottom side of the sensor (vessel mounting)
- Tension belt (vessel mounting)
- Mounting brackets on the housing (ceiling mounting)
- Magnets on the housing (ceiling mounting)

The measurement is made through the closed plastic ceiling of the vessel.

The sensor emits a radar signal through the antenna. The emitted signal is reflected by the medium and received as an echo by the antenna.

The resulting level is converted into a respective output signal and wirelessly transmitted.

The measuring cycle is time-controlled via the integrated clock. Outside of the measuring cycle, the device is in a sleep mode.

Measured value transmission

Depending on the availability of the radio networks and version, the device transmits its measured values wirelessly to an LTE-M (LTE-CAT-M1) or NB-IoT (LTE-CAT-NB1) mobile radio or a plant-side LoRaWAN network.

These versions are available:

- Cellular (LTE-M/NB-IoT) + LoRa
- Cellular (LTE-M/NB-IoT)
- LoRa

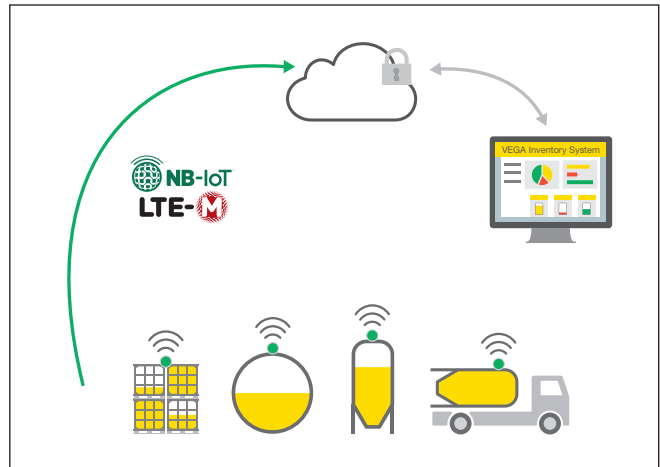

Fig. 2: Wireless measured value transmission via mobile radio

The transmission or evaluation is carried out via an Asset Management System, e.g. VEGA Inventory System.

Voltage supply

The device is supplied with energy by integrated primary cells. The lithium cell used for this purpose is a compact storage device with high cell voltage and capacity for a long service life.



Note:

The primary cells cannot be changed by the user. However, VEGA offers a replacement service for this, see chapter "Exchange cell".

3.3 Adjustment

The device is activated contactlessly from outside:

- By NFC technology via smartphone with VEGA Tools app

- Via magnet (activation via magnet is not possible with the mounting version with magnets)

There are no additional adjustment options.

3.4 Packaging, transport and storage

Packaging

Your instrument was protected by packaging during transport. Its capacity to handle normal loads during transport is assured by a test based on ISO 4180.

The packaging consists of environment-friendly, recyclable cardboard. For special versions, PE foam or PE foil is also used. Dispose of the packaging material via specialised recycling companies.

Transport

Transport must be carried out in due consideration of the notes on the transport packaging. Nonobservance of these instructions can cause damage to the device.

Transport inspection

The delivery must be checked for completeness and possible transit damage immediately at receipt. Ascertained transit damage or concealed defects must be appropriately dealt with.

Storage

Up to the time of installation, the packages must be left closed and stored according to the orientation and storage markings on the outside.

Unless otherwise indicated, the packages must be stored only under the following conditions:

- Not in the open
- Dry and dust free
- Not exposed to corrosive media
- Protected against solar radiation
- Avoiding mechanical shock and vibration

Storage and transport temperature

- Storage and transport temperature see chapter "*Technical data - Ambient conditions*"
- Relative moisture 20 ... 85 %

3.5 Accessories

LoRa-Gateway

The LoRa gateway receives via LoRaWAN the measurement and diagnosis data of appropriately configured VEGA LoRaWAN sensors. The gateway combines the received data and transmits them via mobile network to the VEGA Inventory System.

The measured values and messages are transmitted via the mobile network.

VEGA Inventory System

VEGA Inventory System is a web-based software for simple acquisition, presentation and further processing of measured values.

The measured values are transmitted to the central server via network, internet or cellular radio.

4 Mounting

4.1 General instructions

Ambient conditions

The instrument is suitable for standard and extended ambient conditions acc. to DIN/EN/BS EN/IEC/ANSI/ISA/UL/CSA 61010-1. It can be used indoors as well as outdoors.

Process conditions



Note:

For safety reasons, the instrument must only be operated within the permissible process conditions. You can find detailed information on the process conditions in chapter "Technical data" of the operating instructions or on the type label.

Hence make sure before mounting that all parts of the instrument exposed to the process are suitable for the existing process conditions.

Measurement function and transport

An activated device (see chapter "Activate device") also carries out measurements in horizontal alignment. This also applies if it is mounted on a mobile container and the container is transported in a tilted state.



Note:

When mounting the device on a mobile container, ensure that it is protected against damage throughout transport.

4.2 Mounting instructions

Container requirements

The containers can be commercially available combination IBC containers with a nominal volume of e.g. 1000 l. These typically consist of an inner container made of HDPE, a metal outer cage and a pallet.



Fig. 3: IBC container - Example

Installation position

The device can only be mounted on the top of an IBC container in one of the areas shown below:

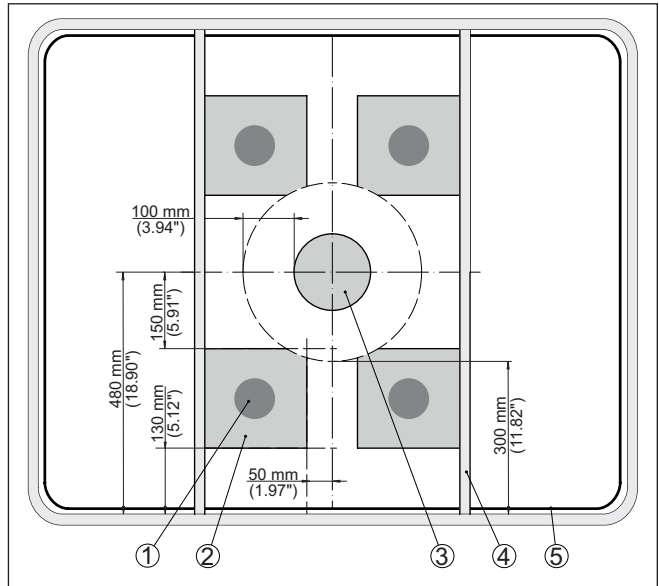

Fig. 4: Mounting position on the tank ceiling

- 1 Recommended mounting position
- 2 Permissible mounting range
- 3 Filling opening
- 4 Cross strut
- 5 Vessel edge

To avoid air bubbles in the area of the adhesive surface, the selected mounting position should be as flat as possible or slightly curved outwards.

**Note:**

Mounting positions or vessel ceilings with an inwardly curved surface are not suitable for fastening.

4.3 Mounting preparations**Mounting preparation adhesive joint**

The intended mounting position must be dry and free of dust, oil and grease before mounting the sensor.

**Note:**

For this reason, clean the container ceiling with the isopropanol-based cleaning cloth supplied. After cleaning the surface, first allow it to flash off well so that any residual solvent can evaporate.

**Warning:**

The 2-propanol contained in the cleaning cloth is highly flammable and harmful to health. Observe the hazard warnings on the packaging and the safety data sheet on our homepage.



Caution:

The cleaning cloth supplied must not be used for chemical residues on the surface. Ask the chemical manufacturer for cleaning options. It is not possible to mount the sensor on a surface that has not been cleaned.

4.4 Installation procedure

Glued connection

The device with adhesive bonding has a mounting ring with adhesive surface on the lower side of the housing.

Proceed as follows:

1. Screw the sensor with the housing cover into the mounting ring
2. Remove the protective foil completely from the adhesive surface
3. Place the sensor on the cleaned mounting surface in one step and press firmly for approx. 30 seconds

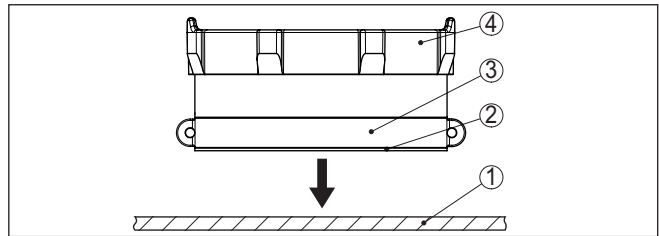

Fig. 5: Mounting adhesive joint

- 1 Vessel top
- 2 Adhesive surface
- 3 Mounting ring
- 4 Housing lid

The glue surface bonds adhesively to the surface of the IBC container and reaches its final adhesive strength after approx. 72 hours. A correction of the sensor position is no longer possible once the adhesive tape has been pressed.



Note:

The adhesive strength is considerably reduced after removal. If the sensor position is subsequently changed, a new adhesive tape must be applied. Please contact your contact person at VEGA.



Danger:

Reattaching the sensor with adhesive tape that is not as good as new means a risk of uncontrolled detachment of the device. This can endanger or damage persons or property (especially during vessel transport). Therefore, only use new adhesive tape.

Flexibly exchangeable holder

The device version with flexibly exchangeable holder is attached to the vessel via the tension belt.

To prevent the device from slipping out of its mounting position, it has a foam pad on the bottom side.

For mounting proceed as follows:

1. Loop the tension belt into the cross struts of the IBC container
2. Insert belt into guides on the housing cover, close click connection

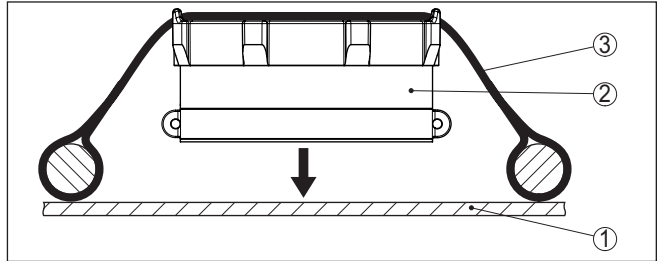

Fig. 6: Mounting flexible exchangeable bracket

- 1 Vessel top
- 2 Foam pad
- 3 Tension belt

3. Slide sensor into mounting position
4. Tighten belt, check sensor for secure fit



Note:

For optimum measurement, ensure direct, permanent contact between the bottom of the sensor and the surface of the IBC container.

Ceiling mounting with screws

The device version for ceiling mounting has mounting brackets on the housing cover. The mounting is carried out using suitable screws and dowels provided by the customer.

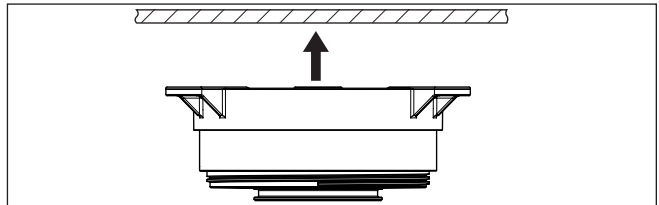

Fig. 7: Ceiling mounting with screws

Ceiling mounting with magnets

The device version for ceiling mounting with magnets has three magnets on the housing lid. This allows the sensor to be attached to ferromagnetic surfaces without drilling or screwing.

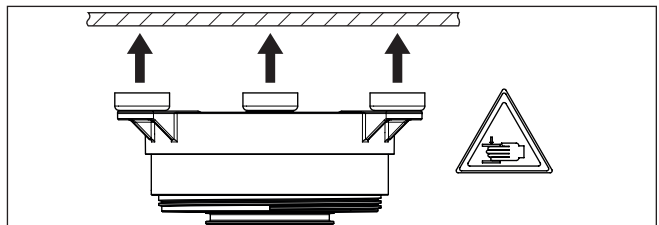

Fig. 8: Ceiling mounting with magnets

**Danger:**

Magnets generate a strong attractive force when attached to metal surfaces. This can lead to fingers or even the whole hand being crushed. Wear safety gloves when attaching and work with special care.

4.5 Transportation lock after mounting

Transportation lock



The adhesive joint and the flexible mounting of the device are only designed for stationary operation of the vessel.

**Danger:**



During transport the vessel is exposed to vibrations and shocks. This can cause the device to fall down with the risk of damage to property or persons. To avoid this, the device must be additionally secured using the integrated safety eyelets on the vessel, e.g. with a metal wire.

5 Setup - the most important steps



Prerequisites

What?	How?
Account in the VEGA Inventory System 	Available from your VEGA contact person
User role supervisor 	Is assigned by your VEGA Inventory System administrator
VEGA Tools app, VEGA Inventory System app 	Download via Apple App Store, Google Play Store, Baidu Store



Activate the sensor

Via magnet	Via smartphone (VEGA Tools app or VEGA Inventory System app)
Move the supplied magnet along the line towards the housing lid 	Call up NFC communication, hold the smartphone close to the side of the device with the lettering "VEGA" 

Set up measuring point in the VEGA Inventory System

Web portal	VEGA Inventory System app
 Menu item "Device networks - Add": Enter serial number and device name	 Menu item "Add device": Scan NFC or QR code on device or enter serial number manually

Configure sensor

Web portal	VEGA Inventory System app
 <p>Menu item "<i>Adjustment/linearization</i>" - Open assistant (measuring range and transmission interval via VEGA Tools app)</p>	 <p>Complete assistant with Linearisation/adjustment</p>

6 Onboarding

6.1 Onboarding on activation with VEGA Inventory System app

1. Open VEGA Inventory System on the Smartphone and log in with the supervisor account.



2. Press "**Add device**".



3. Select the sensor type to be activated.

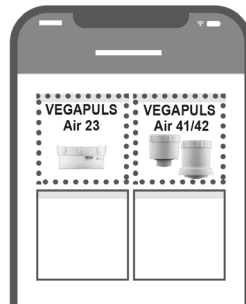

4. Press button "**NFC scan**".

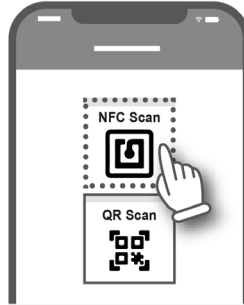

5. Place the smartphone on the side of the housing to the VEGA logo.

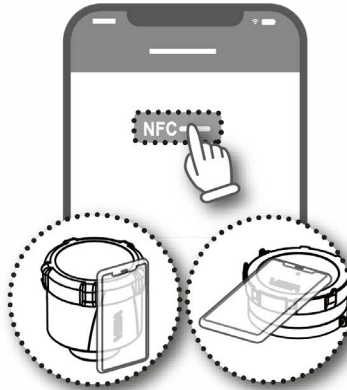

6. Enter device name (e.g. silo number).
 The serial number of VEGAPULS Air 23 is automatically accepted by the app.
 Save setting.

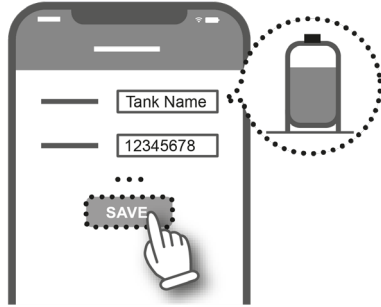

7. Assign a linearization to VEGAPULS Air 23.

To do this, either link an existing linearization or create a new linearization.

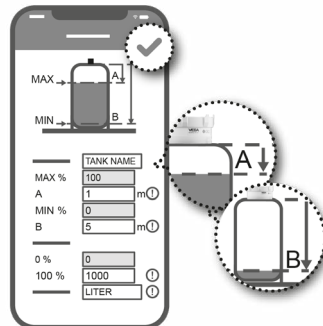

The onboarding of the sensor is completed. The VEGAPULS Air 23 is integrated in the VEGA Inventory System.

6.2 Onboarding on activation with magnet

1. Move the activation magnet clockwise along the lid until the green LED shines through the lid of the VEGAPULS Air 23.

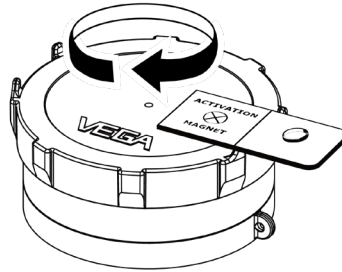

2. Open "vis.vega.com" and log in with the supervisor account.
3. Open "**Configuration - Device networks**" and press "**Add**".

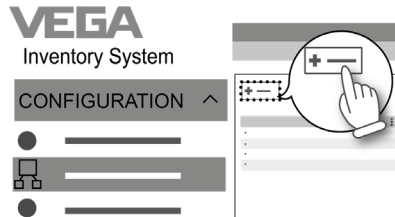

4. Enter serial number and device name (e.g. silo number) of VEGAPULS Air 23 and save.

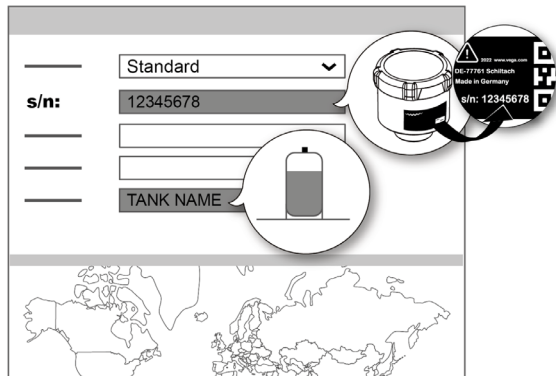

5. Open "**Configuration - Adjustment/Linearization**" and assign a linearization to VEGAPULS Air 23.

To do this, either link an existing linearization or create a new linearization with the linearization assistant.

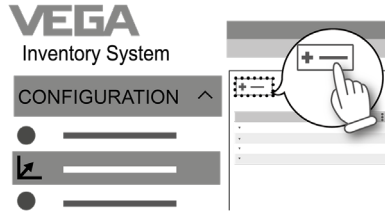

The onboarding of the sensor is completed. The VEGAPULS Air 23 is integrated in the VEGA Inventory System.

7 Activate, device functions

7.1 Activate

Overview

To activate the device from the deactivated state, the following options are available:

- By smartphone with VEGA Tools app via NFC
- Via magnet (activation via magnet is not possible with the mounting version with magnets)

It is not necessary to open the device for activation.



Note:

The device is deactivated in the VEGA Inventory System. A reactivation of the device in the VEGA Inventory System is not possible, but is carried out on site via smartphone or magnet. Take this into account before deactivation!

Activate device - glue mounting

By smartphone

Proceed as follows for activation:

1. Activate NFC communication
2. Start VEGA Tools app
3. Select sensor activation
4. Hold the smartphone close to the top of the radar sensor above the lettering "VEGA"

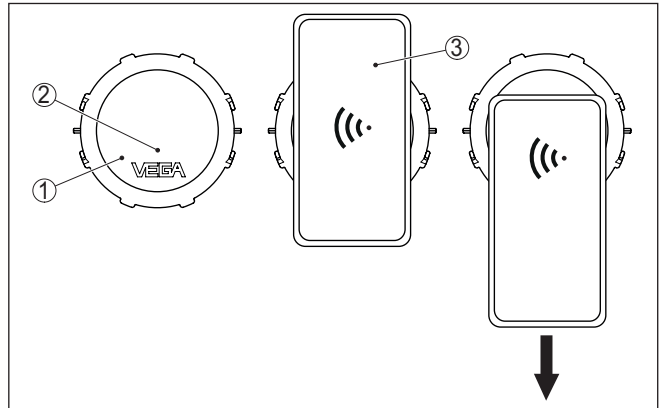

Fig. 9: Activate sensor - Smartphone

- 1 Radar sensor
- 2 Contact surface for NFC communication
- 3 Smartphone

5. Pull smartphone down slowly

The app confirms the successful activation with the message:

"The sensor was activated, serial no.:, device VEGAPULS Air 23"

Setup is now complete and the unit is ready for operation.

Via magnet

Proceed as follows for activation:

→ Hold the magnet close to the upper side of the instrument next to the lettering "VEGA" and move it once around in a circle.

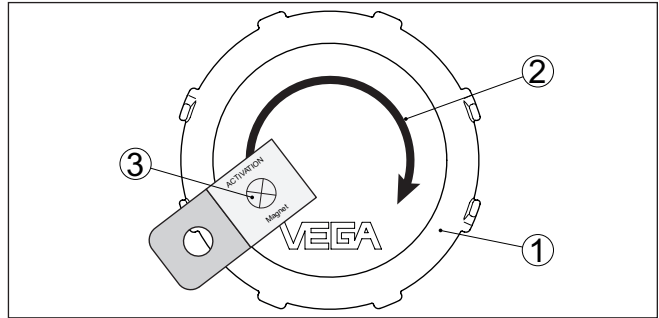

Fig. 10: Activate sensor - Magnet

- 1 Radar sensor
- 2 Contact surface for magnet
- 3 Magnet

Setup is now complete and the unit is ready for operation.

**Activate device -
Ceiling mounting
with screws**

**Note:**

Devices for ceiling mounting must be activated in advance of installation.

By smartphone

Proceed as follows for activation:

1. Activate NFC communication
2. Start VEGA Tools app
3. Select sensor activation
4. Hold the smartphone close to the top of the radar sensor above the lettering "VEGA"

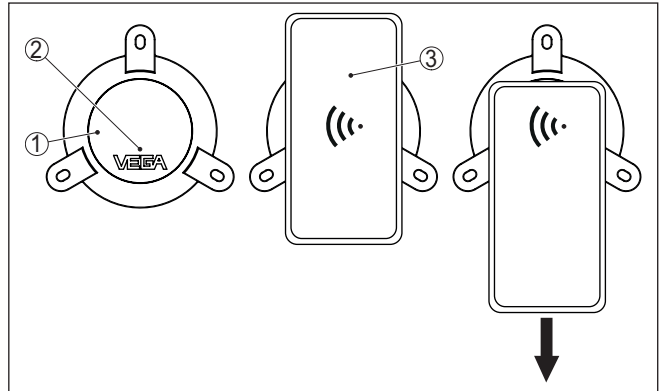

Fig. 11: Activate sensor - Smartphone

- 1 Radar sensor
- 2 Contact surface for NFC communication
- 3 Smartphone

5. Pull smartphone down slowly

The app confirms the successful activation with the message:

"The sensor was activated, serial no.:, device VEGAPULS Air 23"

Setup is now complete and the unit is ready for operation.

Via magnet

Proceed as follows for activation:

→ Hold the magnet close to the upper side of the instrument next to the lettering "VEGA" and move it once around in a circle.

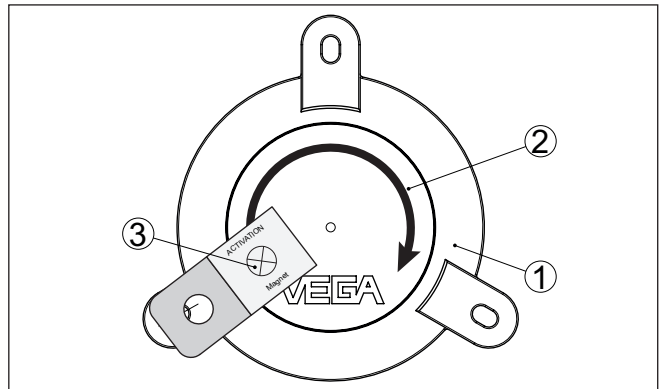

Fig. 12: Activate sensor - Magnet

- 1 Radar sensor
- 2 Contact surface for magnet
- 3 Magnet

Setup is now complete and the unit is ready for operation.

Activate device - Ceiling mounting with magnets



Note:

Devices for ceiling mounting must be activated in advance of installation.

Proceed as follows for activation:

1. Activate NFC communication
2. Start VEGA Tools app
3. Select sensor activation
4. Hold the smartphone close to the top of the radar sensor above the lettering "VEGA"

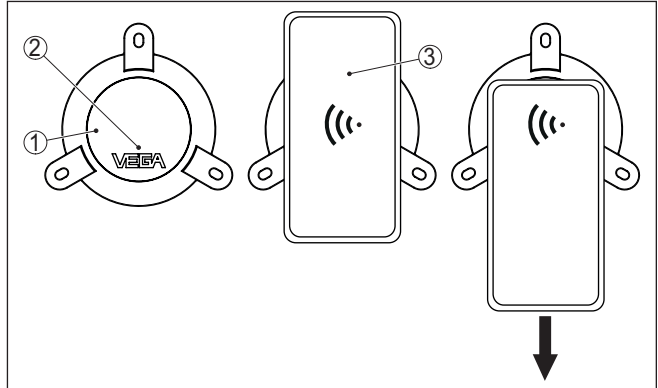

Fig. 13: Activate sensor - Smartphone

- 1 Radar sensor
- 2 Contact surface for NFC communication
- 3 Smartphone

5. Pull smartphone down slowly

The app confirms the successful activation with the message:

"The sensor was activated, serial no.:, device VEGAPULS Air 23"

Setup is now complete and the unit is ready for operation.

7.2 Measurement function

Measured value transmission

After activation, a single measurement is carried out and the cyclic measurement interval is started. The sensor delivers the distance value from the bottom of the antenna to the medium surface. The conversion into level is carried out e.g. in the VEGA Inventory System on the application server or in a cloud service.

Single measurement

The device offers the possibility to test the communication in the respective network. The current measured value is determined and transmitted once outside the cyclical transmission.

The procedure is done by new activation via NFC or magnet as described above. The sensor is simultaneously activated for the cyclical transmission of measured values. The transmission cycle of an already activated sensor is not changed by this.

7.3 Localization

Function

The LTE-M/NB-IoT version of the device has the function "*Location*". This is done using an integrated GNSS/GPS receiver via navigation satellites.¹⁾



Note:

With the LoRa version of the device, the function "*Location*" is not available.

Triggering

With activated position determination, a GPS position determination is performed once during a mobile radio cell change. If no position was found after 300 sec., the position determination will be interrupted and will only be carried out after a new cell change.

¹⁾ GNSS: Global Navigation Satellite System, GPS: Global Positioning System

8 Transfer measured values and data to the cloud

8.1 Communication basics

To transmit the measured values and data to the cloud, the device requires access to mobile network or a LoRaWAN network at the installation site, depending on the version. If no corresponding network is available, a LoRaWAN gateway must be installed.



Note:

Ensure free access to the radio network. The device must not be covered by metal or even enclosed. This especially for the medium height of the housing.



Note:

Simultaneous operation of LTE-M or LTE-IoT and LoRaWAN is not supported.

The following measured values or data are transmitted:

- Distance from the medium surface (m)
- Electronic temperature (°C)
- Geographical position determined by GNSS (geographical coordinates)
- Mounting position (angle °)
- Remaining life of Lithium cells (%)
- Device status

The transmission options are described below.

8.2 NB-IoT/LTE-M - VEGA Inventory System

With NB-IoT (Narrowband Internet of Things) and LTE-M (Long Term Evolution for Machines), the focus is on low data rates and high transmission ranges. Another focus is on penetrating propagation obstacles, such as buildings, for which the long-wave signal is well suited.

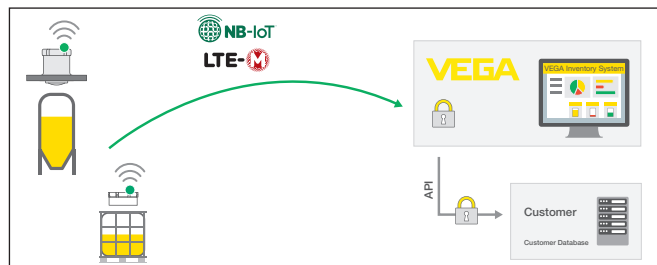

Fig. 14: Wireless measured value transmission via NB-IoT and LTE-M to the VEGA Inventory System

Data is sent via an eSIM card integrated in the sensor. This card sends the data via mobile network directly to the VEGA Inventory System. If no mobile network is available, a fallback to LoRa takes place automatically (see below).

After data transmission via the mobile network, the sensors are automatically made known in the VEGA Inventory System via their serial number. As soon as the sensors are integrated there, the data are available for visualisation.

8.3 LoRaWAN (Fall back) - VEGA Inventory System

LoRaWAN (Long Range Wide Area Network) is the data transmission mode that is available in case of mobile network failure in the area of the measuring point. In this case or in the absence of a mobile network, the device performs an auto-join to LoRa. However, a corresponding gateway is required for this. This gateway picks up the data via LoRa from the sensors and transmits them via cellular radio to VEGA's own LoRa server.

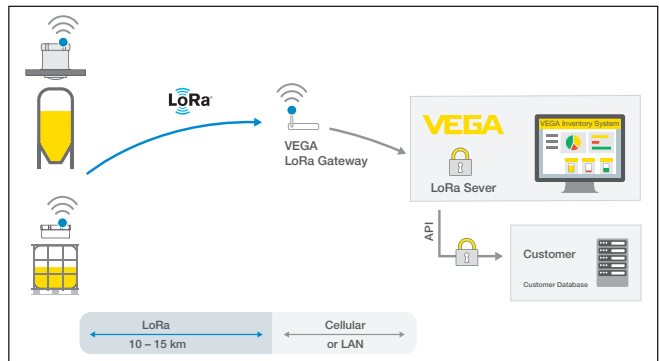

Fig. 15: Wireless measured value transmission via LoRaWAN, LoRa server to the VEGA Inventory System

Both the end devices and the gateways are stored there with their data. The sensors and gateways have so-called Device EUIs via which they can be clearly identified. The LoRa server then transmits the data to the VEGA Inventory System.

8.4 NB-IoT/LTE-M - VEGA Cloud

Data is sent via an eSIM card integrated in the sensor. This card sends the data via the mobile network directly to the VEGA cloud.

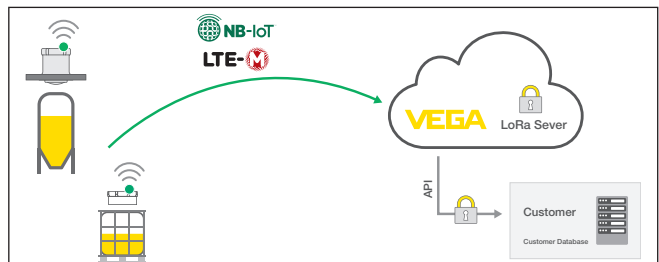

Fig. 16: Wireless measured value transmission via NB-IoT and LTE-M to the VEGA cloud

8.5 LoRaWAN - private networks

Another possibility is to send the data via the user's private LoRaWAN network. In this case, the sensor must be made known in this network.

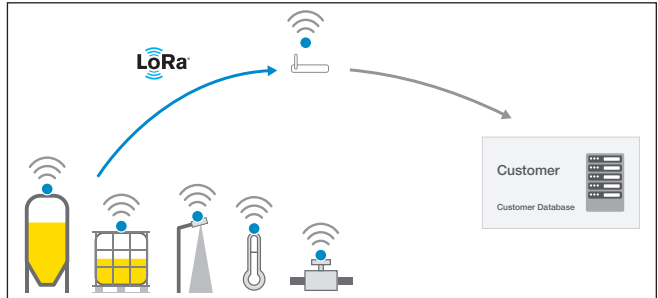

Fig. 17: Wireless measured value transmission

To do this, the user creates the sensor in his interface with its identification values (DevEUI, AppKey and JoinEUI). After a "Join" has been triggered, the sensor appears in the user interface. The transmitted bytes are described in chapter "*Radio network LoRaWAN - data transmission*" and are decoded accordingly in the application system.

9 Set up measuring point via the VEGA Inventory System app

Select device

First select the device you want to add to the VEGA Inventory System:

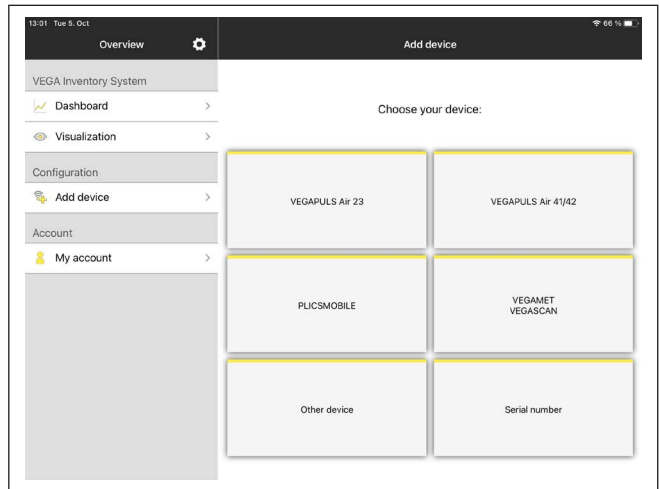

Select method for adding

Select the desired method for adding:

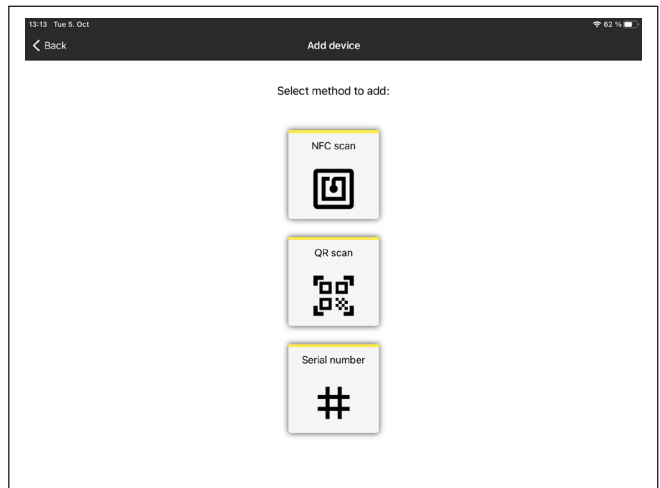

10 Operate device via VEGA Inventory System

Overview

The VEGA Inventory System offers the possibility of remote access via cellular radio to the VEGAPULS Air 23.

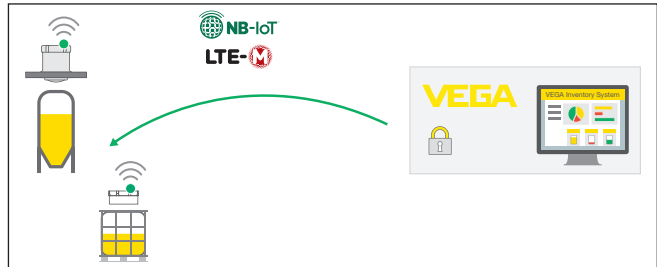

Fig. 18: Remote access from VEGA Inventory System via NB-IoT or LTE-M to the sensor



Note:

This remote access is not supported when connecting via LoRaWAN.

Prerequisites

Prerequisites for the use of this feedback channel are:

- Device software from 1.1.0²⁾
- Current version of the VEGA Inventory Systems
- Available mobile connection via NB-IoT/LTE-M

Access scope

Readable parameters:

- IMEI³⁾

Modifiable parameters:

- Measuring range begin/measuring range end
- Measuring and transmission interval

Triggerable actions:

- Localization

Procedure

The changes are first stored in the VEGA Inventory System. They are transferred to the sensor with the next cyclical measured value transmission and are then effective.



Note:

If parameterization protection is activated in the sensor, this remote access is not available.

²⁾ Devices with this software version or higher have a suitable mobile radio chip. A software update to this version is not possible.

³⁾ International Mobile Equipment Identity

11 Diagnostics and servicing

11.1 Maintenance

Maintenance

If the device is used properly, no special maintenance is required in normal operation.

Cleaning

The cleaning helps that the type label and markings on the instrument are visible.

Take note of the following:

- Only use cleaning agents that do not attack the housing, type plate, seals and the glue connection to the vessel
- Use only cleaning methods corresponding to the housing protection rating
- Keep a distance of at least 0.5 m when using high-pressure cleaners



Caution:

Mounting with a tension belt is generally not suitable for high-pressure cleaning. Depending on the cleaning pressure and distance, the device can loosen from the holder if it is not fixed sufficiently. This can result in personal injury and damage to property. To avoid this, remove the device from the vessel before cleaning.

11.2 Rectify faults

Reaction when malfunction occurs

The operator of the system is responsible for taking suitable measures to rectify faults.

Causes of malfunction

The device offers maximum reliability. Nevertheless, faults can occur during operation. These may be caused by the following, e.g.:

- Sensor
- Process
- Charge state of the lithium cell
- Availability/quality of radio transmission
- Signal processing

Reaction after fault rectification

Depending on the reason for the fault and the measures taken, the steps described in chapter "Setup" must be carried out again or must be checked for plausibility and completeness.

24 hour service hotline

Should these measures not be successful, please call in urgent cases the VEGA service hotline under the phone no. **+49 1805 858550**.

The hotline is also available outside normal working hours, seven days a week around the clock.

Since we offer this service worldwide, the support is provided in English. The service itself is free of charge, the only costs involved are the normal call charges.

11.3 Security Update

If an IT security vulnerability has been identified on a device or device series, VEGA actively approaches affected customers and informs them of the necessary security measures and how to proceed. In addition, corresponding notifications are published on the usual platforms such as CERT@VDE.

The user cannot execute a software update for this device. A software update must be carried out by the manufacturer. VEGA offers a free service for required security updates for affected devices.

If you have any questions, please get in touch with your personal contact. Have the serial number of your device available.

11.4 Cell exchange

The primary cells cannot be changed on site by the user. Improper replacement may impair the metrological properties of the device.

To extend the service life of your device, VEGA offers a replacement service for the lithium cells for the VEGAPULS Air 23.

Return the device as described in chapter "*Procedure in case of repair*" marked as dangerous goods and with the note that the cells are to be changed.

11.5 How to proceed if a repair is necessary

On our homepage you will find detailed information on how to proceed in the event of a repair.

So that we can carry out the repair quickly and without queries, generate a instrument return form there with the data of your device.

The following is required:

- The serial number of the instrument
- A short description of the fault
- Details of the medium, if applicable

Print the generated instrument return form.

Clean the instrument and pack it damage-proof.

Send the printed instrument return form and possibly a safety data sheet together with the device.

You will find the address for the return on the generated instrument return form.

12 Removal with glue connection

12.1 Dismounting instructions

The device can be removed from the surface of an IBC container by unscrewing the sensor housing from the mounting ring. The mounting ring with its adhesive connection remains on the surface of the vessel and can be used for remounting the sensor.

If the mounting ring should be removed, follow the mounting steps in the next section.

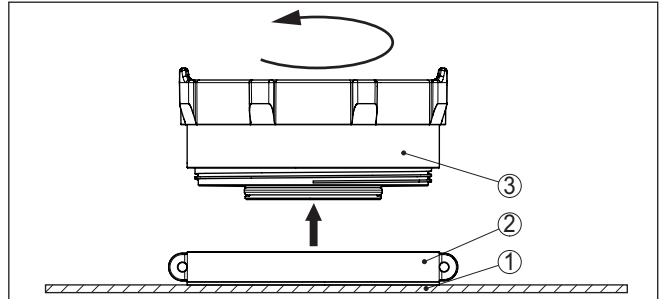

Fig. 19: Removal with glue connection

- 1 Vessel top
- 2 Mounting ring with glue surface
- 3 Sensor



Danger:

If the sensor shows obvious damage, there is a risk of ignition due to a possibly damaged Lithium cell. In this case, the device must not be packed or transported any further.

12.2 Dismounting steps mounting ring

Tool

The following tools are required to remove the mounting ring:

- Strap wrench
- if necessary a wooden scraper



Danger:

Depending on the medium in the IBC container, damage to the container may pose further risks for the user, the effects of which cannot be foreseen. Therefore, inform yourself about the contents of the IBC container before starting dismantling work and follow the instructions of the safety data sheet for the medium.



Caution:

The use of pointed or levering tools for dismantling may result in damage to the IBC container or equipment with the consequences shown above. Therefore, follow the procedure described below and use only tools recommended by VEGA.

Dismount

Proceed as follows while dismantling:

1. Place strap wrench around the mounting ring
2. Twist the mounting ring with the strap wrench, the adhesive bond is dissolved without any major force application.
3. Remove adhesive residues completely using a wooden scraper and dispose of in accordance with local regulations

**Tip:**

If a mounting ring is to be used again, the adhesive surface is available from VEGA as a spare part.

12.3 Disposal



Pass the instrument on to a specialised recycling company and do not use the municipal collecting points.

Remove any batteries in advance, if they can be removed from the device, and dispose of them separately.

If personal data is stored on the old device to be disposed of, delete it before disposal.

If you have no way to dispose of the old instrument properly, please contact us concerning return and disposal.

13 Certificates and approvals

13.1 Radio licenses

Radar

The device has been tested and approved in accordance with the current edition of the applicable country-specific norms or standards.

Regulations for use can be found in the document "*Regulations for radar level measuring instruments with radio licenses*" on our homepage.

Mobile network

The radio modules in the device have been tested and approved according to the current edition of the applicable country-specific norms or standards.

The confirmations as well as regulations for use can be found in the document "*Radio licenses*" supplied or on our homepage.

LPWAN

The radio module in the device has been tested and approved according to the current edition of the applicable country-specific norms or standards.

The confirmations as well as regulations for use can be found in the document "*Radio licenses*" supplied or on our homepage.

13.2 Approvals for Ex areas

Approved versions for use in hazardous areas are available in preparation for the device or the device series.

You can find the relevant documents on our homepage.

13.3 Conformity

The device complies with the legal requirements of the applicable country-specific directives or technical regulations. We confirm conformity with the corresponding labelling.

The corresponding conformity declarations can be found on our homepage.

13.4 Environment management system

Protection of the environment is one of our most important duties. That is why we have introduced an environment management system with the goal of continuously improving company environmental protection. The environment management system is certified according to DIN EN ISO 14001.

Help us to meet these requirements and observe the environmental instructions in the chapters "*Packaging, transport and storage*", "*Disposal*" of this instructions manual.

14 Supplement

14.1 Technical data

Note for approved instruments

The technical data in the respective safety instructions which are included in delivery are valid for approved instruments (e.g. with Ex approval). These data can differ from the data listed herein, for example regarding the process conditions or the voltage supply.

All approval documents can be downloaded from our homepage.

Materials and weights

Materials, non-wetted parts

– Housing	PVDF
– Mounting ring	HDPE
– Foam material on mounting ring with flexibly exchangeable holder	EPDM
– Cover gasket	Silicone

Weight, depending on the version

– Glue connection, ceiling mounting	approx. 0.35 kg (0.772 lbs)
– Ceiling mounting with magnets	approx. 0.41 kg (0.9 lbs)
– Flexibly exchangeable holder	approx. 0.55 kg (1.212 lbs)

Input variable

Measured variable	The measured variable is the distance between the antenna edge of the sensor and the medium surface. The antenna edge is also the reference plane for the measurement.
-------------------	--

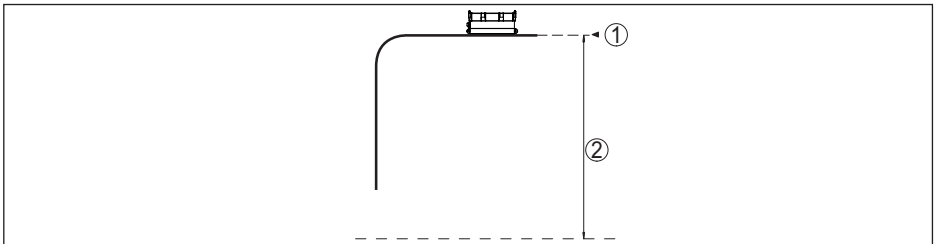

Fig. 20: Data of the input variable

- 1 Reference plane
- 2 Measured variable, max. measuring range

Max. measuring range	3 m (9.84 ft)
----------------------	---------------

Deviation (according to DIN EN 60770-1)

Process reference conditions according to DIN EN 61298-1

– Temperature	+18 ... +30 °C (+64 ... +86 °F)
– Relative humidity	45 ... 75 %
– Air pressure	860 ... 1060 mbar/86 ... 106 kPa (12.5 ... 15.4 psig)

Installation reference conditions

- Distance to installations > 200 mm (7.874 in)
- Reflector Flat plate reflector
- False reflections Biggest false signal, 20 dB smaller than the useful signal

Deviation See following graphic:

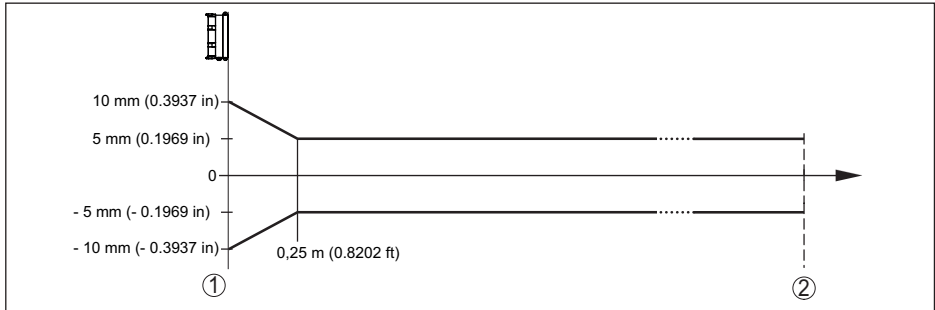

Fig. 21: Deviation under reference conditions

- 1 Reference plane
- 2 Recommended measuring range

Characteristics and performance data

Measuring frequency	W-band (80 GHz technology)
Measuring cycle time	≤ 5 s
Measuring and transmission interval	every 15 minutes ... every 24 hours (configurable on ordering)
Beam angle ⁴⁾	8°
Emitted HF power (depending on the configuration) ⁵⁾	
- Average spectral transmission power density	-3 dBm/MHz EIRP
- Max. spectral transmission power density	+34 dBm/50 MHz EIRP
- Max. power density at a distance of 1 m	< 3 μW/cm ²
Alignment for measurement	vertical 90°, ± 10°

Switch-on phase

Start-up time to the first valid measured value < 10 s

⁴⁾ Outside the specified beam angle, the energy level of the radar signal is 50% (-3 dB) less.

⁵⁾ EIRP: Equivalent Isotropic Radiated Power

Wireless data transmission - mobile radioFrequency bands⁶⁾

- NB-IoT (LTE-Cat-NB1)	B1, B2, B3, B4, B5, B6, B8, B12, B13, B17, B19, B20, B25, B26, B28, B66
- LTE-M (LTE-CAT-M1)	B1, B2, B3, B4, B5, B6, B8, B12, B13, B14, B17, B18, B19, B20, B25, B26, B28, B66

Wireless data transmission - LoRaWAN

LoRaWAN region	EU863-870, US902-928, AU915-928, AS923-1
Max. emitted power	
- EU863-870	14 dBm
- US902-928	14 dBm
- AU915-928	14 dBm
- AS923-1	16 dBm
LoRaWAN Specification Version	V1.0.2
LoRaWAN Regional Parameters Version	1.0.2rB
Class of Operation	A
Optional ADR Feature Supported	Yes
Activation	OTAA

Ambient conditions

Ambient temperature	-20 ... +60 °C (-4 ... +140 °F)
Storage and transport temperature	-20 ... +80 °C (-4 ... +176 °F)

Mechanical environmental conditions

Sinusoidal vibrations	Class 5M2 acc. to IEC 60721-3-5
Impacts (mechanical shock)	10 g, 11 ms; 30 g, 6 ms acc. to IEC 60721-3-5
Impact resistance	IK07 acc. to IEC 62262 ⁷⁾

Process conditions

Process temperature	-20 ... +60 °C (-4 ... +140 °F)
---------------------	---------------------------------

Integrated clock

Date format	Day.Month.Year
Time format	12 h/24 h
Time zone, factory setting	CET
Max. rate deviation	10.5 min/year

Integrated primary cell

Cell type	LS 17500 (Saft), Lithium metal (Li/SOCL ₂), not re-chargeable
-----------	---

⁶⁾ Delivery country-specific according to order configuration

⁷⁾ Testing with hemisphere 50 mm, 500 g, ±25 g

Number of single cells	2
Cell voltage, each	3.6 V
Cell capacitance, each	3.6 Ah
Energy content, each	12.96 Wh
Lithium content, each	approx. 0.9 g
Weight, per typ.	23 g
Self-discharge	< 1 % after 1 year at 20 °C
Running time	

The battery runtime depends on many factors: Reception quality, measurement conditions, temperature fluctuations, radio standard, network provider, ...

Typical measurement tasks under average conditions deliver battery runtimes of over eight years.

The battery runtime calculator provides a detailed calculation with adjustable measurement conditions: www.vega.com/en-de/products/product-catalog/level/radar/vegapuls-air-runtime-calculation

Additional output parameter - Electronics temperature

Range	-20 ... +60 °C (-4 ... +140 °F)
Resolution	< 0.1 K
Deviation	±3 K

Electrical protective measures

Protection rating	
– Glued connection	IP66/IP69 acc. to IEC 60529, Type 6P acc. to NEMA ⁸⁾
– Flexible exchangeable bracket, ceiling mounting	IP66/IP68 (IPX8: 0.2 bar for 24 hr) acc. to IEC 60529, Type 6P acc. to NEMA
– Vessel mounting with ceiling bracket	IP66/IP68 (0.2 bar) acc. to IEC 60529, type 6P acc. to NEMA
Altitude above sea level	2000 m (6562 ft)
Protection class	None (autarkic operation)
Pollution degree	4

14.2 Radio networks LTE-M and NB-IoT

LTE-M and NB-IoT

LTE-M (Long Term Evolution for Machines) and NB-IoT (Narrowband Internet of Things) are extensions of the LTE mobile radio standard to IoT applications. Both enable the wireless connection of mobile, physical objects to the Internet via the mobile network.

You can find more information about the respective mobile phone provider.

⁸⁾ Specifications apply to housings. With IP69 for adhesive bonding in addition to the adhesive tape 2-component adhesive, e.g. 3M type 8005, is additionally required

14.3 Radio networks LoRaWAN - Data transmission

LoRaWAN

LoRaWAN (Long Range Wide Area Network) is a network protocol for wireless signal transmission to a corresponding gateway. LoRaWAN enables a range of several kilometres outdoors and good building penetration with low power consumption of the transmission module.

FPort 2 is used for the uplink of the LoRa data packets.

In the following, the necessary device-specific details are shown. You can find further information of LoRaWAN on www.lora-alliance.org.

Data stream, byte order, packet structure

The data are transferred as a byte stream in packets. Each packet is given an identifier at the beginning which defines the meaning of the following bytes.

Byte sequence according to:

Cayenne Low Power Payload (LPP) Guideline, BigEndian.

Packet 8 is transferred as standard. Alternative packets are required if additional characteristic values (error status, position) occur in the sensor. The maximum packet size is 52 bytes in Europe and 11 bytes in the USA with maximum spread factor.

A LoRa standard function additionally transmits a packet counter and the serial number of the LoRa module with every packet.

Packet structure

Packet group	Physical measured value				Information	
	OK	OK & GPS	Error	Error & GPS	Info1	Info2
Packet	8	9	10	11	16	17
	Number of bytes					
Packet identifier	1	1	1	1	1	1
NAMUR status of the device			1	1		
Measured value as floating point number	4	4	4	4		
Unit measured value	1	1	1	1		
Remaining capacity of the battery in %	1	1	1	1		
Location (GNSS)		8		8		
VEGA Device status			4	4		
Temperature	2	2	2	2		
Unit temperature	1	1	1	1		
Angle of inclination to the perpendicular	1	1	1	1		
Information					1	
DTM ID					4	
Manufacturer code					4	
Device Type					4	
Software version System					1	

Packet group	Physical measured value				Information	
	OK	OK & GPS	Error	Error & GPS	Info1	Info2
Packet	8	9	10	11	16	17
	Number of bytes					
Software version Function					1	
Software version Error					1	
Software version Customer					1	
Measurement/transmission interval					7	
Change counter					2	
Scaling min.					4	
Scaling max.					4	
Device Name						19
Device Tag						19
Total	11	19	16	24	35	39

Packet structure for operation in the USA

	OK	Error 1	Error 2	GPS	Info1	Info2	Info3	Info4
Packet	18	19	20	21	23	24	25	26
	Number of bytes							
Packet identifier	1	1	1	1	1	1	1	1
NAMUR status of the device		1	1	1	1	1	1	1
Measured value as floating point number	4	4						
Unit measured value	1	1						
Remaining capacity of the battery in %	1	1						
Location (GNSS)				8				
VEGA Device status			4					
Temperature	2		2					
Unit temperature	1		1					
Angle of inclination to the perpendicular	1	1						
Information					1			
DTM ID					4			
Manufacturer code					4			
Device Type						4		
Software version System						1		
Software version Function						1		
Software version Error						1		
Software version Customer						1		

64314-EN-250626

	OK	Error 1	Error 2	GPS	Info1	Info2	Info3	Info4
Packet	18	19	20	21	23	24	25	26
	Number of bytes							
Measurement/transmission interval							7	
Change counter							2	
Scaling min.								4
Scaling max.								4
Device Name								
Device Tag								
Total	11	9	9	10	11	10	11	10

NAMUR status

	NAMUR status				
Message NAMUR status	0	1	2	3	4
Meaning	Good	Function Check	Maintenance request	Out of specification	Failure

VEGA Device status

	VEGA Device status	
Message VEGA device status	1016 32100
Meaning	see "Message detail status" in chapter "Status messages acc. to NAMUR NE 107"	

Example data transmission

Packet 8, data record 0x083FA31F152D2401042009

Byte 1	Byte 2 ... 5	Byte 6	Byte 7	Byte 8 ... 9	Byte 10	Byte 11
0x08	0x3FA31F15	0x2D	0x24	0x0104	0x20	0x09
Packet identifier	Measured value	Unit measured value	Remaining capacity of the battery in %	Temperature	Unit temperature	Angle of inclination to the perpendicular
8	1.27439	0x2D = 45 = m	36 %	26	0x20 = 32 = °C	9°

14.4 Dimensions

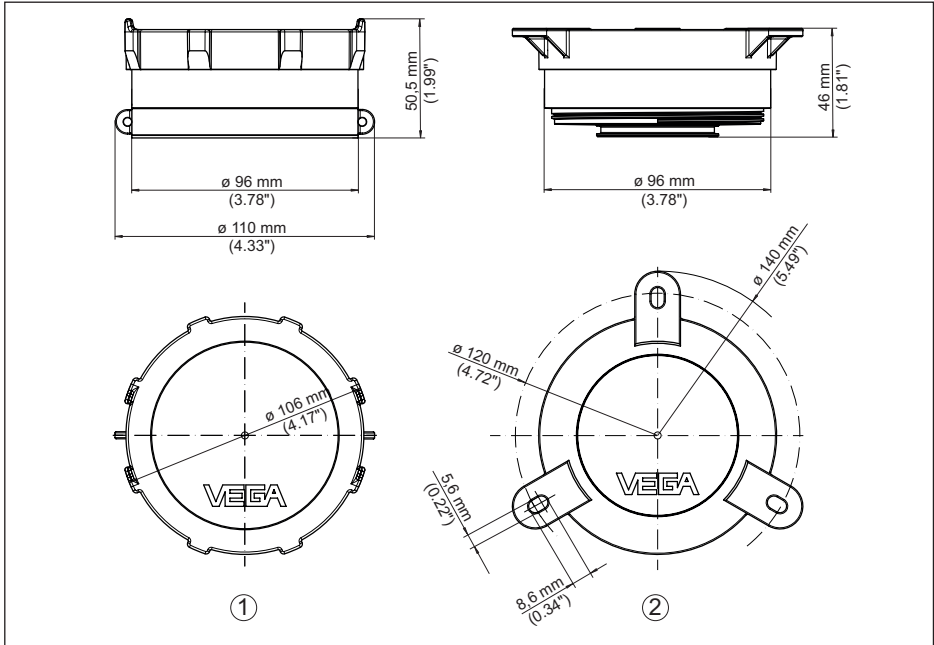

Fig. 22: Dimensions VEGAPULS Air 23

- 1 Version for adhesive and tension belt mounting
- 2 Version for ceiling mounting

14.5 Industrial property rights

VEGA product lines are global protected by industrial property rights. Further information see www.vega.com.

VEGA Produktfamilien sind weltweit geschützt durch gewerbliche Schutzrechte.

Nähere Informationen unter www.vega.com.

Les lignes de produits VEGA sont globalement protégées par des droits de propriété intellectuelle. Pour plus d'informations, on pourra se référer au site www.vega.com.

VEGA líneas de productos están protegidas por los derechos en el campo de la propiedad industrial. Para mayor información revise la pagina web www.vega.com.

Линии продукции фирмы ВЕГА защищаются по всему миру правами на интеллектуальную собственность. Дальнейшую информацию смотрите на сайте www.vega.com.

VEGA系列产品在全球享有知识产权保护。

进一步信息请参见网站www.vega.com。

14.6 Licensing information for open source software

Open source software components are also used in this device. A documentation of these components with the respective license type, the associated license texts, copyright notes and disclaimers can be found on our homepage.

14.7 Trademark

All the brands as well as trade and company names used are property of their lawful proprietor/originator.

A large grid of graph paper for taking notes, consisting of 20 columns and 30 rows of small squares.

Printing date:

VEGA

All statements concerning scope of delivery, application, practical use and operating conditions of the sensors and processing systems correspond to the information available at the time of printing.

Subject to change without prior notice

© VEGA Grieshaber KG, Schiltach/Germany 2025

64314-EN-250626

VEGA Grieshaber KG
Am Hohenstein 113
77761 Schiltach
Germany

Phone +49 7836 50-0
E-mail: info.de@vega.com
www.vega.com