

The rigid stem configuration makes installation fast and easy

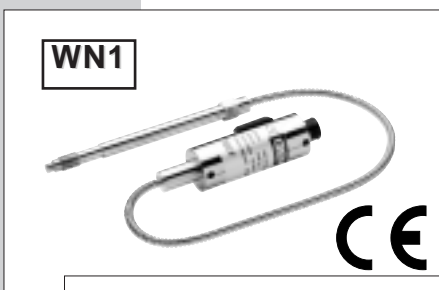

The flexible configuration is designed for applications requiring further thermal isolation or where installation would be otherwise difficult or impractical

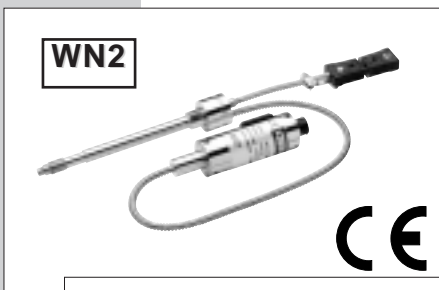

The pressure / temperature configuration requires only one mounting hole for the measurement of both process values

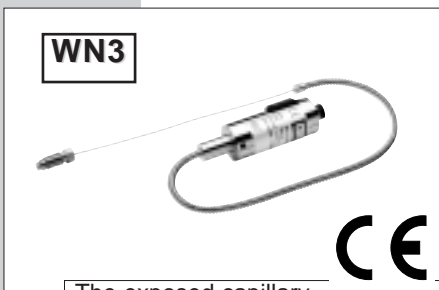

The exposed capillary configuration is ideal to fit in space restricted locations

Main features

- Pressure ranges from:
0-35 to 0-1000 bar / 0-500 to 0-15000 psi
- Strain gage Wheatstone bridge
- Accuracy :
$\pm 0.25\% \text{ FSO (H)}$; $\pm 0.5\% \text{ FSO (M)}$
- Internally generated 80% calibration signal (R-Cal)
- Fluid-filled system for temperature stability
- Oil filling meets FDA requirements
CFR 178.3620 and CFR 172.878
- Fully interchangeable with all existing brands
- Grade of protection: IP65 (6-pin connector version)
- 1/2-20UNF , M18x1.5 standard threads ; other types available on request
- Standard diaphragm is a 17-7 PH stainless steel TiN (Titanium Nitride) coated corrugated diaphragm

TECHNICAL SPECIFICATIONS

Nominal accuracy including Linearity, Repeatability, Hysteresis	H $\pm 0.25\% \text{ FSO}$ (350...1000 bar) M $\pm 0.5\% \text{ FSO}$ (35...1000 bar)
Resolution	Infinite
Measurement range	0..35 to 0..1000bar 0..500 to 0..15000psi
Maximum overpressure	2 x FS 1.5 x FS above 500bar/7500psi
Measurement principle	Strain gage Wheatstone bridge
Supply voltage	15-30Vdc
Maximum current consumption	40mA (1)
Isolation resistance (at 50Vdc)	>1000 MOhm
Full Scale Output (FSO)	5Vdc (M) 10Vdc (N)
Zero balance	0Vdc
Signals adjustment : Nominal pressure Ambient pressure	5% FSO min. 10 bar (150psi)
Maximum load	1mA
Response time (10 to 90% FSO)	~ 4ms
Output noise (RMS 10-400Hz)	< 0.05% FSO
Calibration signal	80% FSO
Protection against output shortcircuit and supply voltage inverted polarity	YES
Protection against output voltage spikes	YES according to 89/336/EEC
Strain gauge housing compensated temperature range	0...+76°C 32...170°F
Maximum housing temperature range	-30...+85°C -22...185°F
Thermal drift in compensated range Zero/Calibr./Sens.	< 0.02% FSO/°C < 0.01% FSO/°F
Diaphragm maximum temperature	315°C 600°F
Zero drift due to change in process temperature	0.04 bar/°C 30 psi/100°F
Material in contact with process medium	- Standard 17-7PH corrugated diaphragm with Titanium Nitride coating - Optional 17-7PH corrugated diaphragm with Chromium Nitride coating
Thermocouple (model WN2)	STD : type "J" (isolated junction)
Protection degree	IP65
Electrical connections	6-pin Conn. VPT07RA10-6PT (PT02A-10-6P) 8-pin Conn. PC02E-12-8P

(1) Conditions : 30Vdc supply, maximum allowed load, calibration shunt inserted
FSO = Full Scale Output (output signal at nominal pressure)

MECHANICAL DIMENSIONS

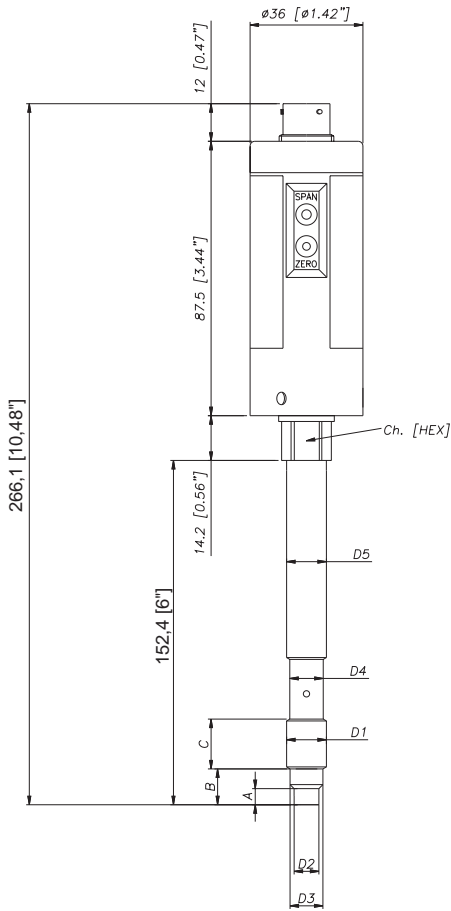

WN0

D1	1/2 - 20UNF
D2	ø7.8 -0.05 [ø0.31" -0.002]
D3	ø10.5 -0.025 [ø0.41" -0.001]
D4	ø10.67 [ø0.42"]
D5	ø12.7 [ø0.5"]
A	5.56 -0.26 [0.22" -0.01]
B	11.2 [0.44"]
C	15.74 [0.62"]
Ch [Hex]	16 [5/8"]

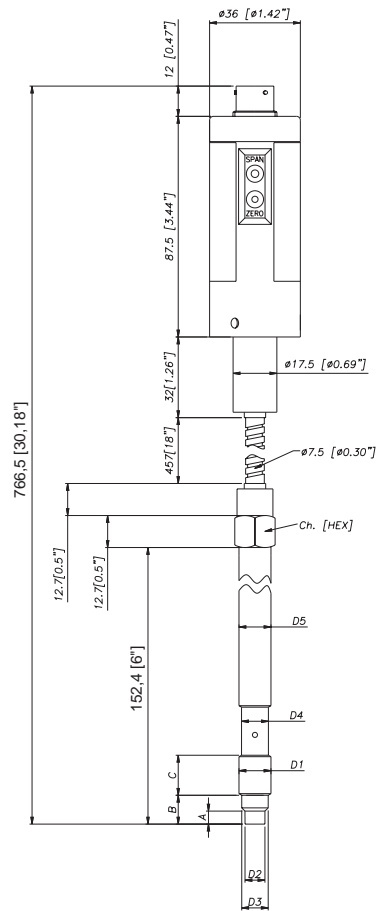

WN1

D1	M18x1,5
D2	ø10 -0.05 [ø0.394" -0.002]
D3	ø16 -0.08 [ø0.63" -0.003]
D4	ø16 -0.4 [ø0.63" -0.016]
D5	ø18 [ø0.71"]
A	6 -0.26 [0.24" -0.01]
B	14.8 -0.4 [0.58" -0.016]
C	19 [0.75"]
Ch [Hex]	19 [3/4"]

NOTE :
Dimensions refer to rigid stem length option "4" (153mm - 6")

WARNING :
For installation use a maximum tightening torque of 56 Nm (500 in-lb)

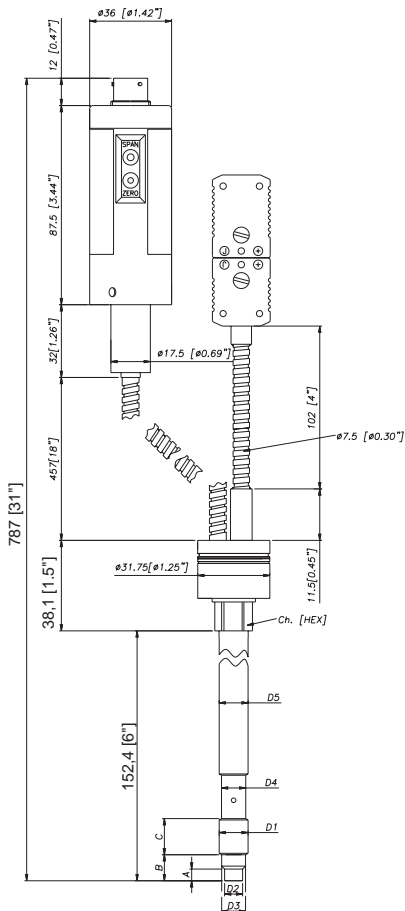

WN2

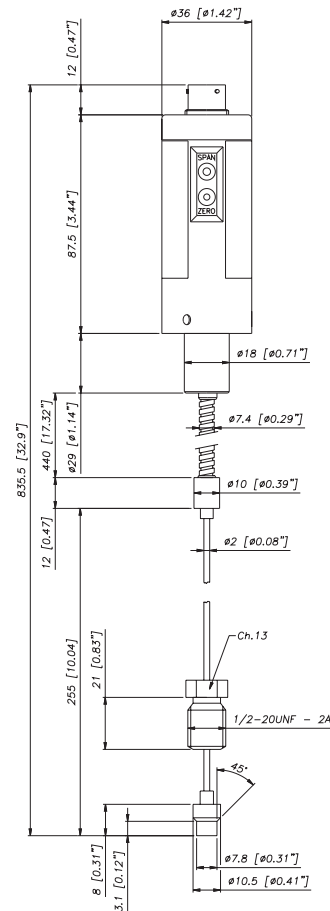

WN3

ELECTRICAL CONNECTIONS

VOLTAGE OUTPUT (M, N)

Power supply 15..30Vdc

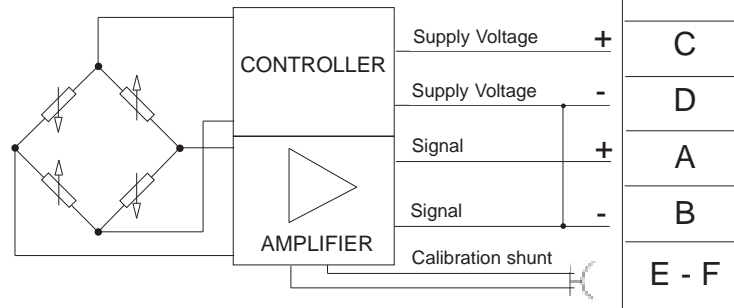

Shield drain wire is tied to connector via cable clamp

ADJUSTMENTS

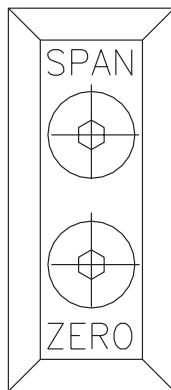

ZERO and SPAN adjustment can be made by relative trimpots inside the transmitter body and accessible after removing the two protection screws.

SPAN is factory set and should not be adjusted.

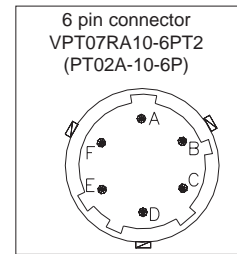

ACCESSORIES

Connectors

6-pin mating connector (IP65 protection degree)

CON300

Extension cables

6-pin connector with 8m (25ft) cable
 6-pin connector with 15m (50ft) cable
 6-pin connector with 25m (75ft) cable
 6-pin connector with 30m (100ft) cable
 Other lengths

C08WLS
C15WLS
C25WLS
C30WLS
consult factory

Cable color code

Conn.	Wire
A	Red
B	Black
C	White
D	Green
E	Blue
F	Orange

Accessories

Mounting bracket
 Dummy plug for 1/2-20UNF
 Dummy plug for M18x1.5
 Drill kit for 1/2-20UNF
 Drill kit for M18x1.5
 Cleaning kit for 1/2-20UNF
 Cleaning kit for M18x1.5

SF18
SC12
SC18
KF12
KF18
CT12
CT18

Thermocouple for WN2 model

Type "J" (153mm - 6" stem)

TTER 718

ORDER CODE

W - [] - [] - [] - [] - [] - [] - [] - [] - **000**

OUTPUT SIGNAL	
0 .. 5Vdc	M
0 .. 10Vdc	N
0.1 .. 5.1Vdc	B
0.1 .. 10Vdc	C
0..5Vdc (supply -15/+15Vcc)	H
0 .. 10Vdc (supply -15/+15Vcc)	L

VERSION	
Rigid stem	0
Rigid stem + flexible	1
With thermocouple	2
Exposed capillary	3

CONNECTOR	
Standard	
6 pin	6

ACCURACY CLASS	
0.25% FSO (ranges ≥ 350 bar/5000 psi)	H
0.5% FSO	M

RANGE			
bar		psi	
35	B35U	500	P05C
50	B05D	750	P75D
70	B07D	1000	P01M
100	B01C	1500	P15C
200	B02C	3000	P03M
350	B35D	5000	P05M
500	B05C	7500	P75C
700	B07C	10000	P10M
1000	B01M	15000	P15M

000 = Standard version
Special or customized versions available on request

FLEXIBLE LENGTH (*) (mm / inches)		
Standard (WN0)		
0	none	
Standard (WN1, WN2)		
D	457mm	18"
E	610mm	24"
F	760mm	30"
Standard (WN3)		
L	711mm	28"
Available on request		
A	76mm	3"
B	152mm	6"
C	300mm	12"

RIGID STEM LENGTH (*) (mm / inches)		
Standard (WN0, WN1, WN2)		
4	153mm	6"
5	318mm	12.5"
Standard (WN3)		
0	none	
Available on request		
1	38mm	1.5"
2	50mm	2"
3	76mm	3"
6	350mm	14"
7	400mm	16"
8	456mm	18"

(*) Note : maximum combined stem/flex length is 914mm - 36"

THREAD	
Standard	
1	1/2 - 20 UNF
4	M18 x 1.5

Examples

WN2-6-M-B07C-1-4-D-000

Melt pressure transmitter with type "J" thermocouple, 0..10Vdc output, 6-pin connector, 1/2-20UNF thread, 700bar full scale, 0.5 % accuracy class, 153 mm (6") rigid stem, 457mm (18") flexible capillary.

WM0-6-M-P03M-1-4-0

Melt pressure transmitter, rigid stem, 0..5Vdc output, 6-pin connector, 1/2-20UNF thread, 3000psi full scale, 0.5 % accuracy class, 153 mm (6") rigid stem

GEFRAN reserves the right to make any kind of design or functional modification at any moment without prior notice.

GEFRAN spa
via Sebina, 74
25050 PROVAGLIO D'ISEO (BS) - ITALIA
tel. 0309888.1 - fax. 0309839063
Internet: <http://www.gefran.com>

GEFRAN

cod. WN - 09/04