

Series DRVI

USE AND MAINTENANCE MANUAL
ETHERNETIP V1.9

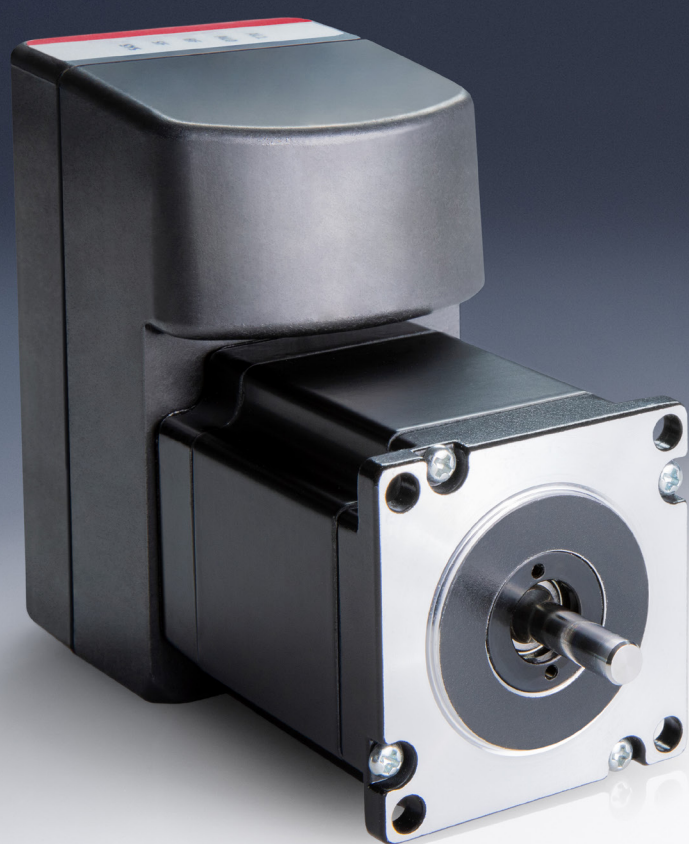

Contents

Chapter 1 General recommendations	1
1.1 Product storage and transport	2
1.2 Use	2
1.3 Limitations of use	2
1.4 Maintenance	2
1.5 Ecological Information	3
Chapter 2 Introduction	4
2.1 About this manual	4
2.2 Unit overview	4
Chapter 3 Technical data	5
3.1 Environmental conditions	5
3.2 Electrical specifications	5
3.2.1 Power supply	5
3.2.2 Wiring	6
3.2.3 Encoder	6
3.3 Electrical connections	7
3.3.1 1 - Power supply	8
3.3.2 2 - GPIO	8
3.3.3 3 - STO (Safety Torque Off)	11
3.3.3.1 STO function validation	12
3.3.4 4, 5 - Ethernet fieldbus interface	13
3.3.5 6 - USB interface	14
3.3.6 Earth connection	14
3.4 LED indicators	14
3.5 Holding Brake	16
Chapter 4 Operation Modes	17
4.1 Fieldbus Modes	17
4.1.1 Speed	17
4.1.2 Positioning	18
4.1.2.1 Relative Positioning	19
4.1.2.2 Absolute Positioning	19
4.1.3 Torque	19
4.1.4 Jog	20
4.1.5 Homing	21
4.1.5.1 Positioning homing	21
4.1.5.2 Proximity homing: negative direction	21
4.1.5.3 Proximity homing: positive direction	21

4.1.5.4	Proximity homing: negative direction + zero encoder	22
4.1.5.5	Proximity homing: positive direction + zero encoder	23
4.1.5.6	Torque homing: negative direction	23
4.1.5.7	Torque homing: positive direction	23
4.1.5.8	Torque homing: negative direction + zero encoder	24
4.1.5.9	Torque homing: positive direction + zero encoder	24
4.1.5.10	Homing offset	25
4.2	Digital Input mode	26
4.2.1	Application example	26
4.2.2	Functioning	27
4.2.3	Self-holding with positioning	29
4.2.4	Error handler	29
4.2.5	Proximity lost error	30
Chapter 5	Other features	31
5.0.1	Profile software limits	31
5.0.2	Torque limit	31
5.0.3	Save and restore actual position	32
Chapter 6	EtherNet/IP Protocol	33
6.1	Conventions	33
6.2	Startup parameters	34
6.3	Cyclic data	35
6.3.1	Control word	36
6.3.2	Mode operation	38
6.3.2.1	NONE	38
6.3.2.2	SPEED	38
6.3.2.3	POS_REL, POS_ABS	39
6.3.2.4	TORQUE	39
6.3.2.5	HOMING_0, ... HOMING_8	39
6.3.2.6	JOG	39
6.3.3	Output GPIO	39
6.3.4	Target position	40
6.3.5	Target speed	40
6.3.6	Target acceleration	40
6.3.7	Target deceleration	40
6.3.8	Target torque	40
6.3.9	Status word	40
6.3.10	Actual mode operation	41
6.3.11	Diagnostic word	41
6.3.12	Actual speed	43
6.3.13	Actual pos	43
6.3.14	Actual torque	43

6.3.15	Inputs	43
6.4	Acyclic data	43
6.4.1	Acyclic parameters descriptions	44
6.4.1.1	6040h Controlword	44
6.4.1.2	6041h Statusword	44
6.4.1.3	6060h Mode of operation	44
6.4.1.4	6061h Mode of operation display	44
6.4.1.5	6064h Position actual value	44
6.4.1.6	606Ch Velocity actual value	44
6.4.1.7	6071h Target torque	44
6.4.1.8	6077h Torque actual value	45
6.4.1.9	607Ah Target position	45
6.4.1.10	607Ch Home offset	45
6.4.1.11	607Eh Polarity	45
6.4.1.12	6081h Target Velocity	45
6.4.1.13	6083h Profile acceleration	45
6.4.1.14	6084h Profile deceleration	45
6.4.1.15	6087h Torque slope	45
6.4.1.16	6099h Homing speeds	46
6.4.1.17	609Ah Homing acceleration	46
Chapter 7	Uvix	47
7.1	Introduction	47
7.2	General information	48
7.3	Status information	49
7.4	Details	50
7.4.1	Variables	50
7.4.2	Alarms	52
7.4.3	Commands	54
7.4.4	Errors History	55
7.4.5	Graphs	55
7.5	Configuration	57
7.5.1	Actuator	57
7.5.2	Motion	58
7.5.3	Communication	59
7.5.4	GPIO	59
7.6	Commissioning	60
7.6.1	Standard commissioning page	60
7.6.1.1	Mode operation selector	61
7.6.1.2	Command of the movement	61
7.6.1.3	Mode operation section	61
7.6.1.4	Homing section	62
7.6.1.5	Speed Profile section	64

7.6.1.6	Absolute position section	65
7.6.1.7	Relative position section	66
7.6.1.8	Torque profile section	67
7.6.2	Digital Input mode commissioning page	68
7.6.2.1	Jog section	69
7.6.3	PID configuration section	70
7.7	EthernetIP configuration	72
7.8	UVIX USB Gateway	73
7.8.1	Main page	73
7.8.2	Ethernet device configuration	74

General recommendations

▲ Please comply with the recommendations for safe use described in this document.

- Some hazards can only be associated with the product after it has been installed on the machine/equipment. It is the responsibility of the end user to identify these hazards and reduce the risks associated with them.
- For information regarding the reliability of the components, contact Camozzi Automation.
- Before commissioning, carefully check that the DRVI has been correctly configured with regard to the data relating to the determination of the position and movement of the device. Failure to follow these instructions can result in injury or equipment damage.
- Avoid unprotected contact with hot surfaces. Be sure that the DRVI can dissipate the heat generated during normal operation to avoid equipment damage.
- Read the information in this document carefully before using the product.
- Keep this document in a safe place and close at hand for the whole of the product's life cycle.
- Pass this document on to any subsequent owner or user.
- The instructions in this manual must be observed in conjunction with the instructions and additional information concerning the product in this manual, available from the following reference links:
 - Website www.camozzi.com
 - Camozzi general catalogue
 - Technical assistance service
- Assembly and commissioning must be performed exclusively by qualified and authorised personnel on the basis of these instructions.
- It is the responsibility of the system/machine designer to ensure the correct selection of the most suitable component according to the intended application.
- Use of appropriate personal protective equipment is recommended to minimise the risk of physical injury.
- For all situations not contemplated in this manual and in situations in which there is the risk of potential damage to property, or injury to persons or animals, contact Camozzi for advice.
- Do not make unauthorised modifications to the product. In this case, any damage or injury to property, persons or animals will be the responsibility of the user.
- It is recommended to comply with all safety regulations that apply to the product.
- Never intervene on the machine/system until you have verified that all working conditions are safe.
- Before installation or maintenance, ensure that the required safety locks are active, and then disconnect the electrical mains (if necessary) and system pressure supply, discharging all residual compressed air from the circuit and deactivating residual energy stored in springs, condensers, recipients and gravity.
- After installation or maintenance, the electrical power supply (if necessary) must be reconnected, and the regular operation of the product must be checked. In the event of a malfunction, the product

1.1 Product storage and transport

must not be used.

- Avoid covering the equipment with paint or other substances that may reduce heat dissipation.

1.1 Product storage and transport

- Adopt all measures possible to avoid accidental damage to the product during transport, and when available use the original packaging.
- Observe the specified storage temperature range of $-20 \div 70$ °C.

1.2 Use

- Make sure that the distribution network voltage and all operating conditions are within the permissible values.
- The product may only be used in observance of the specifications provided; if these requirements are not met, the product may only be used upon authorisation by Camozzi.
- Follow the indications shown on the identification plate.

1.3 Limitations of use

- Do not exceed the technical specifications given in Paragraph 2 (General characteristics and conditions of use) and in the Camozzi general catalogue.
- Do not install the product in environments where the air itself may cause hazards.
- With the exception of specific intended uses, do not use the product in environments where direct contact with corrosive gases, chemicals, salt water, water or steam may occur.
- In the event of breakage of the polymer casing (for example following external impacts), where the electronic circuits reside, the DRVI is no longer usable. Remove power from the device and, wearing the necessary PPE (Personal Protection Equipments), proceed with the complete replacement with a new DRVI device.

1.4 Maintenance

- Incorrectly performed maintenance operations can compromise the good working order of the product and harm surrounding persons.
- Check conditions to prevent sudden release of parts, then suspend the power supply and allow residual stresses to discharge before taking action.
- Assess the possibility of having the product serviced by a technical service centre.
- Never disassemble a live unit.
- Isolate the product electrically before maintenance.
- Always remove accessories before maintenance.
- Always wear the correct personal protective equipment as envisaged by local authorities and in compliance with current legislation.

1.5 Ecological Information

- In the event of maintenance, or replacement of worn parts, exclusively use the original Camozzi kits and ensure that operations are performed by specialised and authorised personnel. Otherwise product approval will be rendered invalid.

1.5 Ecological Information

- At the end of the product's life cycle, it is recommended to separate the materials for recycling.
- Follow the waste disposal regulations in force in your country.
- The product and relative parts all comply with the ROHS and REACH standards.

Introduction

2.1 About this manual

This manual contains the technical description of the universal integrated servomotor, designed by Camozzi Automation S.p.A.

▲ Failure to observe the information contained in this manual can result in injury or equipment damage.

Please contact Camozzi Automation S.p.A. for technical assistance.

PRODUCT SPECIFICATIONS AND DATA ARE SUBJECT TO CHANGE WITHOUT NOTICE.

© Camozzi Automation S.p.A. All rights reserved.

2.2 Unit overview

The universal integrated servomotor unit is composed of a brushless or stepper motor and a FOC (Field Oriented Control) drive.

The unit is equipped with interface, that provides fieldbus communication capability with other devices, such as PLCs.

An absolute encoder allows to detect the rotor position of the motor, which is a fundamental quantity for the closed-loop control algorithms.

The power supply is divided in two sections: one for the logic stage and one for the power stage. In the following chapter are described the technical data of the drive.

Technical data

3.1 Environmental conditions

⚠ The drive installation must respect the environmental conditions specified in Table 3.1.

Table 3.1: Environmental conditions.

Condition	Value
Protection class	IP65, except motor shaft
Operating ambient temperature	-20 ... 50 °C (*)
Storage ambient temperature	-20 ... 70 °C
Air humidity (non-condensing)	5 ... 95 %
Maximum altitude	1000 m

(*) for stepper motor (DRVI-23ST012 and DRVI-24ST022) the nominal torque must be derated for temperature over 30°C.

3.2 Electrical specifications

3.2.1 Power supply

The power supply section of the drive is divided into two parts:

- Logic (VL): provides supply to the logic stage, fieldbus interface and input-outputs.
- Main (VDC): provides supply to the power stage.

It's recommended to supply both Logic and Main power supplies by 2 different PELV (Protective Extra-Low Voltage) electronic circuits compliant to EN 60204-1

In Table 3.8 are shown the power supply operating ranges.

Table 3.2: Power supplies ranges.

Supply	Nominal value	Min/Max values
VL	24 V	24 V ±10%
VDC	48 V	15V / 60 V

The current absorption of the logic stage is <200mA (including auxiliary +24V output at maximum load).

⚠ During deceleration ramps the motor acts as a generator, returning a voltage on the VDC bus. The entity of such regeneration depends on the deceleration value and on the moment of inertia of the load attached to the shaft. If the voltage generated reaches the maximum VDC voltage, **the excess energy must be dissipated using an external braking system**, or changing the deceleration value otherwise the drive or the power supply could be damaged.

⚠ Install fuses for power supply cable in accordance with the electrical requirements of the equipment (be careful about inrush currents). A recommended fuse value is **T4A**.

3.2 Electrical specifications

It is also recommended to install a capacitor of 1000 μ F, rated 100 V, after the output of the power supply.

⚠ The drive does not have an inrush current limitation, hence you must use the input of the power supply to turn the drive on and off. Never switch the output voltage of the power supply (hot plugging). In Figures 3.1 and 3.2 are shown the wiring examples for VDC and VL.

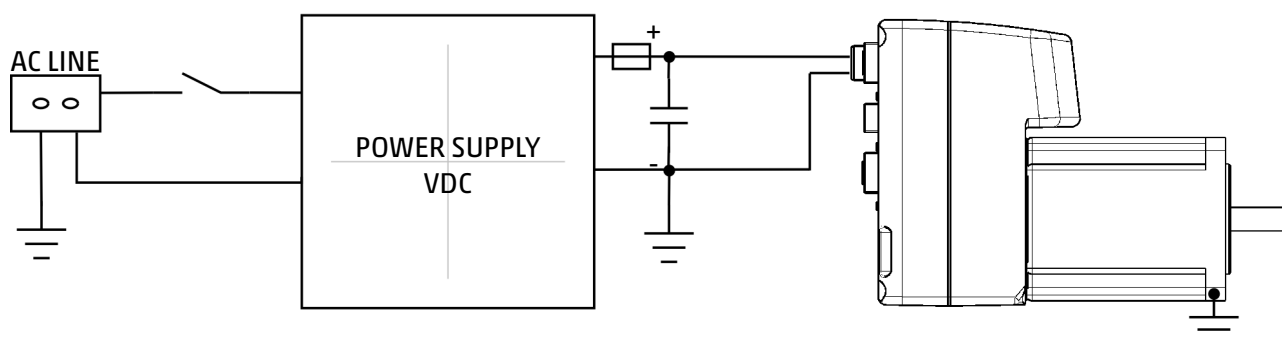

Figure 3.1: VDC wiring example.

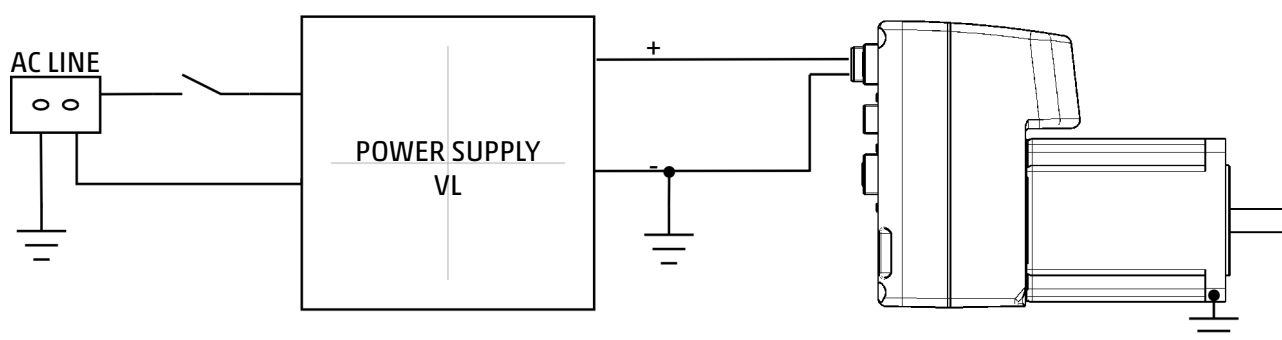

Figure 3.2: VL wiring example.

3.2.2 Wiring

The actual cable type, wire gauge, shield type, and filtering devices used are dependent on the environment, application, and system. However, we advise to use the following guidelines, when sizing the cables:

- The minimum section for the power supply cable should be AWG22 when the motor uses the nominal current.
- For length less than 15 m, DC power supply cables can be used. Otherwise AC power supply cables should be used.
- To reduce EMC issues, use twisted and shielded cables.
- The shield should be connected to ground on the power supply side.

3.2.3 Encoder

The motor shaft position is measured using an absolute magnetic encoder.

3.3 Electrical connections

3.3 Electrical connections

In Figure 3.3 is shown the placement of the electrical connectors.



Figure 3.3: Connectors placement.

In Table 3.3 are shown the functionalities of the electrical connectors.

Table 3.3: Electrical connections.

Connection	Name	Functionality
①	PSW	Power supply
②	I/O	Inputs and outputs
③	STO	Safe Torque Off (when present)
④	P1 = PORT 1	EthernetIp Fieldbus Interface
⑤	P2 = PORT 2	EthernetIp Fieldbus Interface
⑥	-	USB (Micro-B)

NOTE: All connectors are screw type. During the wiring phase, be careful not to tighten the connectors too forcefully. The use of tools to tighten the connectors is absolutely not recommended.

3.3 Electrical connections

3.3.1 1 - Power supply

The power supply connector is a 5-poles M12 (male) A-coded. In Table 3.4 is represented the pinout of the power supply connector.

Table 3.4: 1 - Power supply connector pinout.

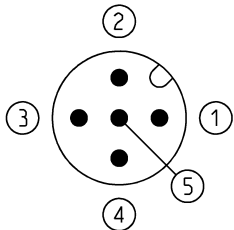
PIN	Signal	Function	Symbol
1, 5	VDC	Main power supply	
2	GND	Main power ground	
3	VL	Logic power supply	
4	GND	Logic power ground	

Camozzi connector receptacle:

- CS-LF05HC, straight connector M12 5-poles male.
- CS-LF04HB, straight connector M12 5-poles male (Pin 5 is not connected).
- CS-LF05HB-D200, cable with straight M12 5-poles male connector, length 2m.
- CS-LF05HB-D500, cable with straight M12 5-poles male connector, length 5m.

⚠ The pins with GND indication are internally connected.

3.3.2 2 - GPIO

The GPIO connector is a 12-poles M12 (female) A-coded. The description of pinouts changes depending on the Input mode:

- Fieldbus Input mode: functionality of each pin is described in Table 3.5.
- Digital Input mode (4.2): functionality of each pin is described in Table 3.6.

3.3 Electrical connections

Table 3.5: 2 - GPIO connector pinout for Fieldbus Input mode.

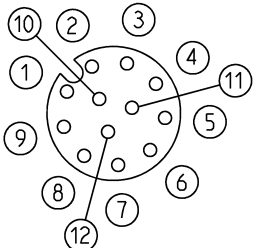
PIN	Signal	Function	Symbol
1, 2	IN1	Digital input 1 (compliant to IEC61131-2)	
3, 4	IN2	Digital input 2 (compliant to IEC61131-2)	
5, 6	OUT	Solid state relay output (PTC resettable fuse, 0.5 A hold current)	
7, 8	EXT PROXY	Digital input (24 V) for end-stroke proximity	
9, 10	PROXY HOMING	Digital input (24 V) for homing proximity	
11	GND	Digital ground	
12	+24V	Auxiliary +24 V output, max 130 mA	

NOTE: the EXT PROXY is usually used to connect the optional limit switch sensor, whilst the PROXY HOMING is used for the homing zero position

3.3 Electrical connections

Table 3.6: 2 - GPIO connector pinout for Digital Input mode.

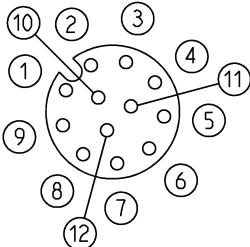
PIN	Signal	Function	Symbol
1, 2	IN FW	Forward input (compliant to IEC61131-2)	
3, 4	IN BW	Backward input (compliant to IEC61131-2)	
5, 6	OUT ERR	Solid state relay output (PTC resettable fuse, 0.5 A hold current)	
7, 8	FRONT PROXY	Digital input (24 V) for front proximity	
9, 10	REAR PROXY	Digital input (24 V) for rear proximity	
11	GND	Digital ground	
12	+24V	Auxiliary +24 V output, max 130 mA	

3.3 Electrical connections

Camozzi connector receptacle:

- CS-LM12HC, circular connector field attachable M12 12-poles (male) A-coded.
- CS-LO12HC-0025, straight connector M12 12-poles (male) and two M8 female (proximity), length 25 cm.
- CS-LM12HC-D500, straight connector M12 12-poles (male), length 5m.

Digital inputs are bidirectional: in Figure 3.4 is represented the input hardware stage.

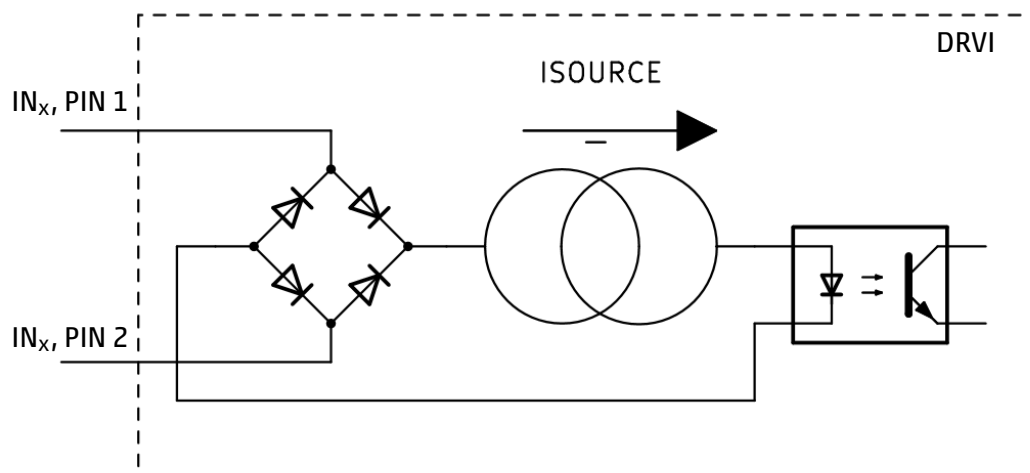

Figure 3.4: GPIO IN stage.

In Figure 3.5 is represented the output hardware stage.

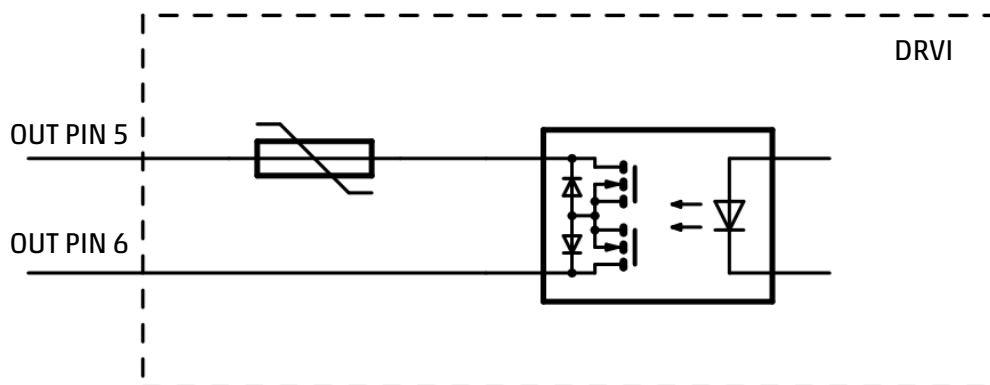

Figure 3.5: GPIO OUT stage.

3.3.3 3 - STO (Safety Torque Off)

The STO connector (when present) is 4-poles M8 (female) A-coded. In Table 3.7 is shown the connector pinout and is displayed the STO connector. To allow the motor movement, IN1 and IN2 must be connected to +24 V, while COM1 and COM2 to GND. If IN1 or IN2 voltages are missing, the STO intervenes disconnecting the motor phases.

Camozzi connector receptacle:

- CS-DM04HB, circular connector field attachable M8 4-poles (male) A-coded.
- CS-LM04HB-D500, straight connector M8 4-poles (male), length 5m.

3.3 Electrical connections

Table 3.7: 3 - STO connector pinout.

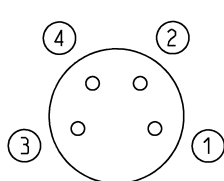
PIN	Signal	Function	Symbol
1	IN1	STO1 signal	
2	COM1	Common signal of STO1	
3	IN2	STO2 signal	
4	COM2	Common signal of STO2	

3.3.3.1 STO function validation

To check if the STO is correctly installed and working, follow these steps:

- Turn on the DRVI, send some movements command and check that all is ok (preliminary)
- Stop the motor and take out 24V at pin IN1 and IN2
- Verify that the torque is off and that the motor can be moved freely (if there is no motor brake mounted)
- Verify that red SYS LED blinks 3 times. It is also possible to verify that the DRVI send an error message on the field bus (see the User Manual for details)
- Verify that any movement commands the DRVI doesn't move
- Restore 24V at pin IN1 and IN2
- Verify that DRVI remains stopped in error state, with red led blinking
- Reset the error, set the torque ON, send a movement command to DRVI and check that everything is ok
- Run the motor and take out 24V at pin IN1 and IN2 while the motor is running
- Verify that the motor stops by inertia, then repeat the procedure described before with motor stopped

Below a table with the motor status due to the STO1 and STO2 signals:

3.3 Electrical connections

Table 3.8: STO inputs and motor status.

IN1	IN2	PWM e alimentazione motore	Descrizione
0	0	Motor disabled	The motor is disabled with DRVI in error state and there is no ways to move the motor
0	24V	Motor disabled	The motor is disabled with DRVI in error state and there is no ways to move the motor
24V	0	Motor disabled	The motor is disabled with DRVI in error state and there is no ways to move the motor
24V	24V	Motor enabled	The motor is enabled and ready to move

3.3.4 4, 5 - Ethernet fieldbus interface

The Fieldbus connectors are 4-poles M12 (female) D-coded. In Table 3.9 are shown the connector pinout and the fieldbus connector (PORT 1, PORT 2).

Table 3.9: 4, 5 - Fieldbus connector pinout.

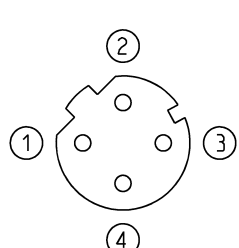
PIN	Signal	Function	Symbol
1	TXP	Transmission data (+)	
2	RXP	Reception data (+)	
3	TXN	Transmission data (-)	
4	RXN	Reception data (-)	

3.4 LED indicators

Camozzi Ethernet fieldbus cables:

- CS-SB04HB-D100, co-molded cable with straight M12D 4-poles male connector, length 1m.
- CS-SB04HB-D500, co-molded cable with straight M12D 4-poles male connector, length 5m.
- CS-SB04HB-DA00, co-molded cable with straight M12D 4-poles male connector, length 10m.
- CS-SB04HB-DD00, co-molded cable with straight M12D 4-poles male connector, length 15m.
- CS-SB04HB-DG00, co-molded cable with straight M12D 4-poles male connector, length 20m.
- CS-SB04HB-DJ00, co-molded cable with straight M12D 4-poles male connector, length 25m.
- CS-SB04HB-DM00, co-molded cable with straight M12D 4-poles male connector, length 30m.
- CS-SB04HB-DS00, co-molded cable with straight M12D 4-poles male connector, length 40m.
- CS-SB04HB-DY00, co-molded cable with straight M12D 4-poles male connector, length 50m.
- CS-SE04HB-F050, molded cable with straight RJ45 male – M12D 4 pin female connector (adapter and panel mount) to connect to the controller.

3.3.5 6 - USB interface

The USB port allows the drive configuration using the UVIX interface. The USB connector is a Micro USB type B.

Camozzi connector receptacle:

- G11W-G12W-2, standard cable with micro-USB connector length 2m.

3.3.6 Earth connection

⚠ It is mandatory to connect the motor flange to earth (\perp). The GND must be connected to the earth, using a common central point, near to the power supply.

3.4 LED indicators

The integrated drive provides visual information using LED indicators. Their functionality is shown in Table 3.10, and their detailed description is given in Table 3.11.

Table 3.10: LED indicators functionality.











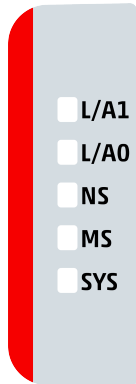













Name	Color	Function	Indicator
L/A1	Green / yellow (bicolor)	Link / activity LED for Ethernet channel 1	
L/A0	Green / yellow (bicolor)	Link / activity LED for Ethernet channel 0	
NS	Red / green (bicolor)	Network status	
MS	Red / green (bicolor)	Module status	
SYS	Red / green (bicolor)	Drive system LED	

Table 3.11: LED indicators description.

Name	Color	State	Description
L/A1		OFF	No link has been established on Ethernet Port 0
		ON	Link has been established on Ethernet Port 1
		BLINK	Data is received or transmitted on Ethernet Port 1
L/A0		OFF	No link has been established on Ethernet Port 0
		ON	Link has been established on Ethernet Port 0
		BLINK	Data is received or transmitted on Ethernet Port 0
NS		OFF	No link has been established
		ON	Connected
		BLINKING	Initializing
		ON	Waiting to connect
		BLINKING	Duplicate IP
MS		ON	Device operational (device operating correctly)
		BLINKING	Standby (device not configured)
		ON	Non-recoverable major fault
		BLINKING	Recoverable minor fault
		BLINKING	Self-test: device is performing power-up testing
		OFF	No power supplied
SYS		1 BLINK	Servo OFF
		2 BLINK	Servo ON
		1 BLINK	VL / VDC UVLO or OVLO error
		2 BLINK	Over temperature or I ² T error
		3 BLINK	STO error
		4 BLINK	Homing error / internal error / proximity lost

3.5 Holding Brake

3.5 Holding Brake

The DRVI is available with an optional integrated holding brake. It is controlled automatically by the DRVI: when the device is turned off, in error state and in general when the servo is off the brake is automatically activated (it keeps the motor shaft stationary), while when the motor is running or is enabled to move (the servo state is on) the brake is disengaged.

NOTE: this type of brake is not a Safety brake. It is engaged and disengaged as described before but its rule is not for a safety purpose NOTE: this type of brake is not a dynamic one: if you need a brake that automatically ensure you to stop immediately the movement with the maximum allowable load, you have to use an appropriate external brake.

Operation Modes

This Chapter describes the possible operation modes of the drive that could be fieldbus modes or Digital Input mode

4.1 Fieldbus Modes

4.1.1 Speed

This drive mode operation requires a specific target speed, acceleration and deceleration: once the velocity target is set, the motor accelerates until the target speed is reached and then maintains the required velocity until a new request is made. The speed profile executed is trapezoidal.

In Figure 4.1 is shown an example of speed profile with the following parameters:

- Target acceleration = 60 RPM / s
- Target deceleration = 60 RPM / s
- Initial speed = 0 RPM
- Target speed = 60 RPM (target given at $t = 0$ s)
- Target speed = 0 RPM (target given at $t = 2$ s)

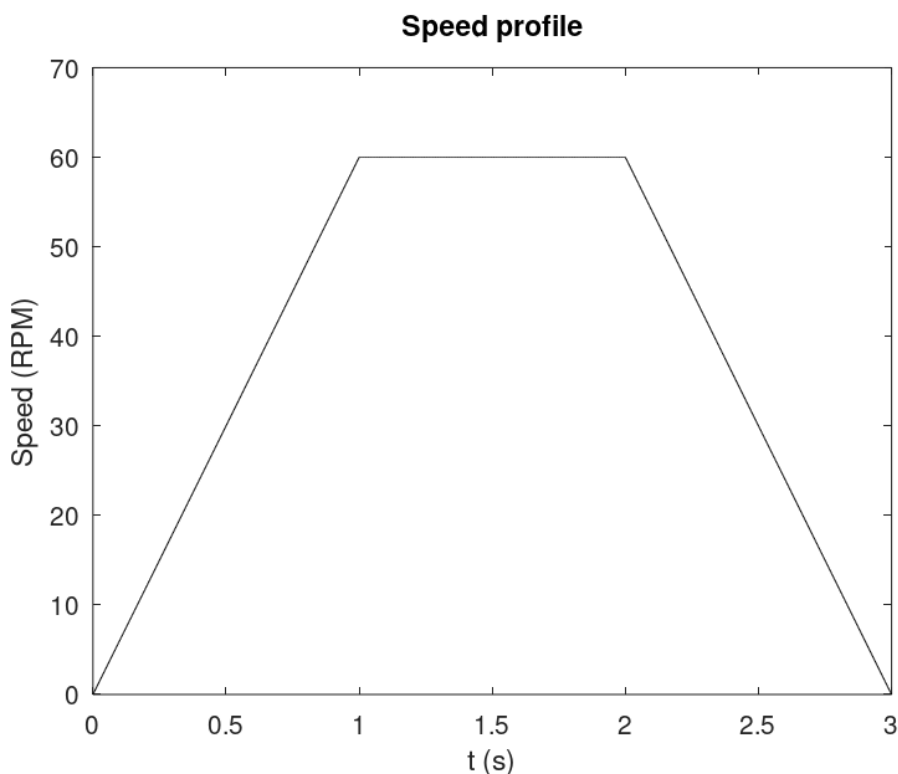

Figure 4.1: Speed profile example.

4.1 Fieldbus Modes

4.1.2 Positioning

This drive operation modes requires a specific target position, velocity, acceleration and deceleration, to compute the motion profile used to reach the target position. The position profile executed is of "S" type and the speed profile is trapezoidal.

In Figure 4.2 is shown an example of positioning profile with the following parameters:

- Initial position = 0 °
- Target position = 720 ° (target given at t = 0 s)
- Initial speed = 0 RPM
- Target speed = 60 RPM
- Target acceleration = 60 RPM / s
- Target deceleration = 60 RPM / s

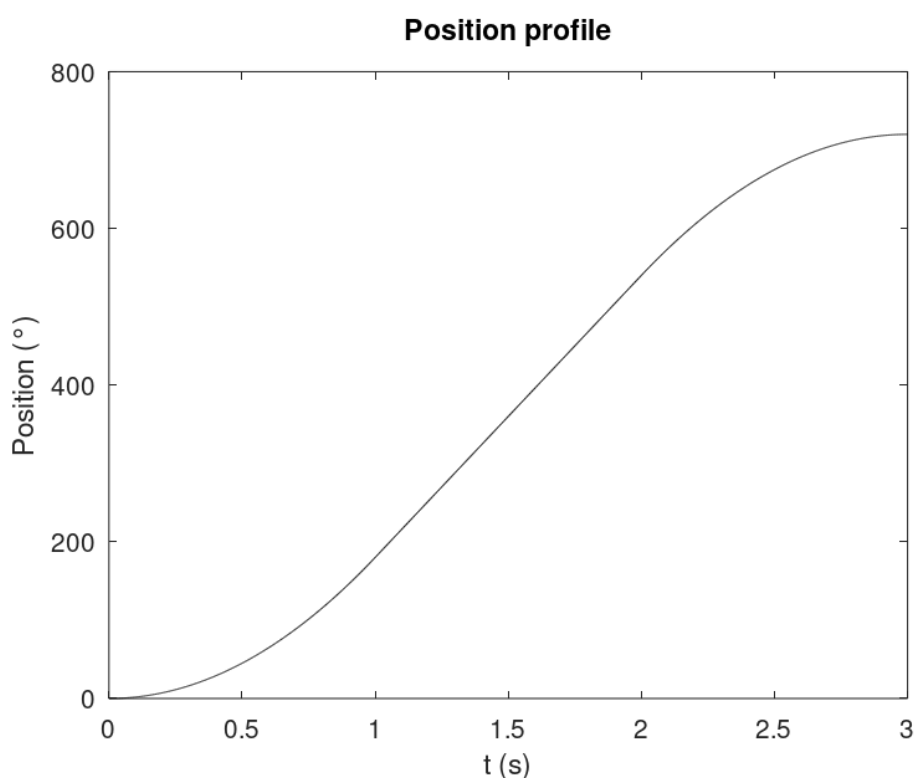

Figure 4.2: Positioning profile example.

In Figure 4.3 are represented both the position (continuous line) and speed (dashed line) profiles per unit (position / 360 ° and speed / 60 RPM).

4.1 Fieldbus Modes

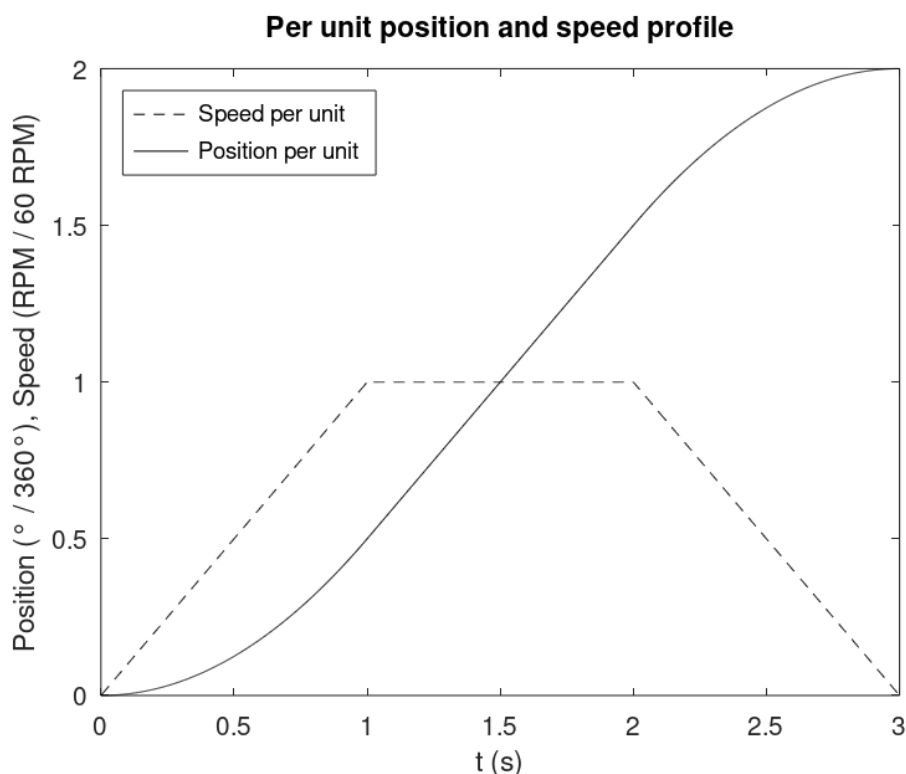

Figure 4.3: Positioning and speed profile example.

4.1.2.1 Relative Positioning

In relative positioning profile the target is computed as offset with respect to the current position. For example, if the actual absolute rotor position is 360° and the requested relative positioning target is 360° , the motor will rotate to reach the absolute position of 720° .

4.1.2.2 Absolute Positioning

In absolute positioning profile the target is absolute. For example, if the absolute rotor position is 360° and an absolute positioning target of 360° is given, the motor will not move.

4.1.3 Torque

This drive operation mode requires a specific target (current) torque, positive torque slope and negative torque slope. Target torque is expressed in mA and torque slopes in mA / s.

In Figure 4.4 is shown an example of torque profile with the following parameters:

- Positive torque slope = 1000 mA / s
- Negative torque slope = 1000 mA / s
- Initial torque = 0 mA
- Target torque = 1000 mA (target given at $t = 0$ s)
- Target torque = 0 mA (target given at $t = 2$ s)

4.1 Fieldbus Modes

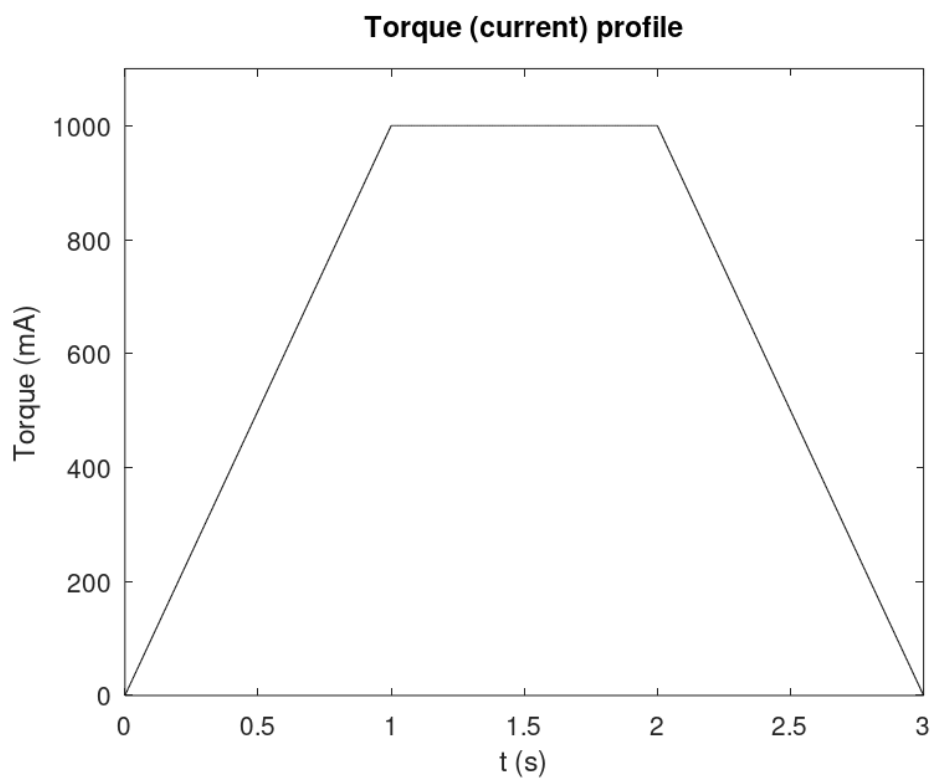

Figure 4.4: Torque (current) profile example.

4.1.4 Jog

The JOG mode allows to control the drive in speed mode using two bits of the controlword

4.1 Fieldbus Modes

4.1.5 Homing

In this Section are described the possible homing procedures. It is mandatory to execute homing before using positioning operations. Homing parameters can be configured using UVIX interface (refer to Section 7.6.1.4). If proximity is used it must be connected to the PROXY INPUT (refer to Section 3.3.2).

4.1.5.1 Positioning homing

Homing at the current position (refer to Figure 4.5). This mode does not require an external proximity

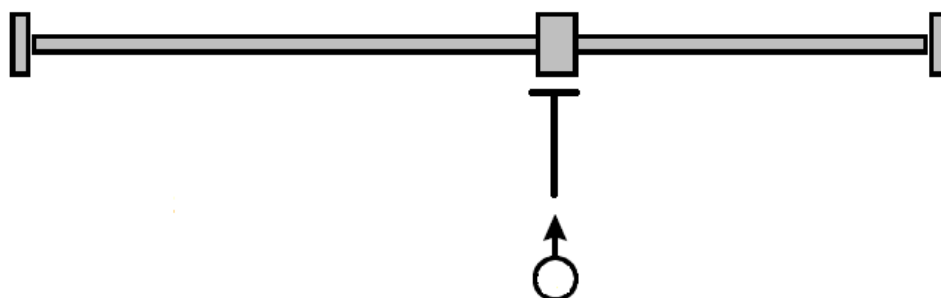

Figure 4.5: Positioning homing.

and the homing procedure consists of setting the current position (without moving the motor) as zero position.

4.1.5.2 Proximity homing: negative direction

Proximity search in negative direction (refer to Figure 4.6).

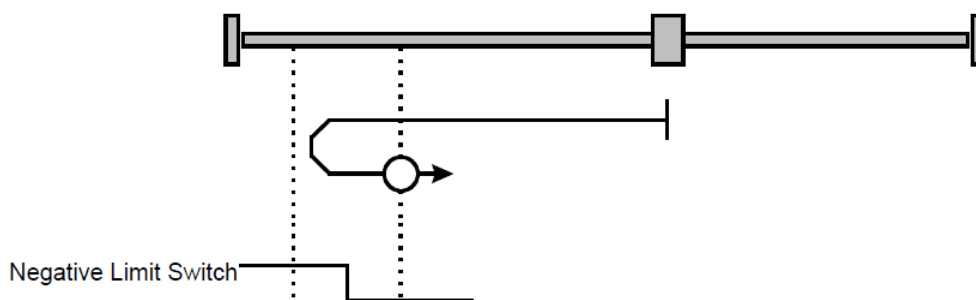

Figure 4.6: Proximity homing: negative direction.

In this mode, the motor searches for the zero proximity in the negative direction of the movement, with the velocity set to "homing speed search". As soon as the proximity is detected, the motor stops and exits the proximity, in the opposite direction, with the velocity set to "homing speed out". If the proximity is already detected on the start of the homing procedure, the motion will start with the "homing speed out" phase. If the proximity is surpassed because of the inadequate speed / deceleration combination, the homing procedure is interrupted and a homing error is returned.

4.1.5.3 Proximity homing: positive direction

Proximity search in positive direction (refer to Figure 4.7).

4.1 Fieldbus Modes

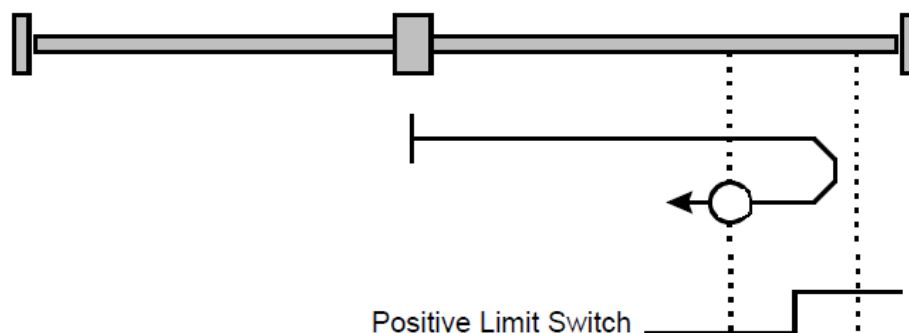

Figure 4.7: Proximity homing: positive direction.

In this mode, the motor searches for the zero proximity in the positive direction of the movement, with the velocity set to "homing speed search". As soon as the proximity is detected, the motor stops and exits the proximity, in the opposite direction, with the velocity set to "homing speed out". If the proximity is already detected on the start of the homing procedure, the motion will start with the "homing speed out" phase. If the proximity is surpassed because of the inadequate speed / deceleration combination, the homing procedure is interrupted and a homing error is returned.

4.1.5.4 Proximity homing: negative direction + zero encoder

Proximity search in negative direction and then search for the index pulse (zero of the encoder) in the positive direction (refer to Figure 4.8).

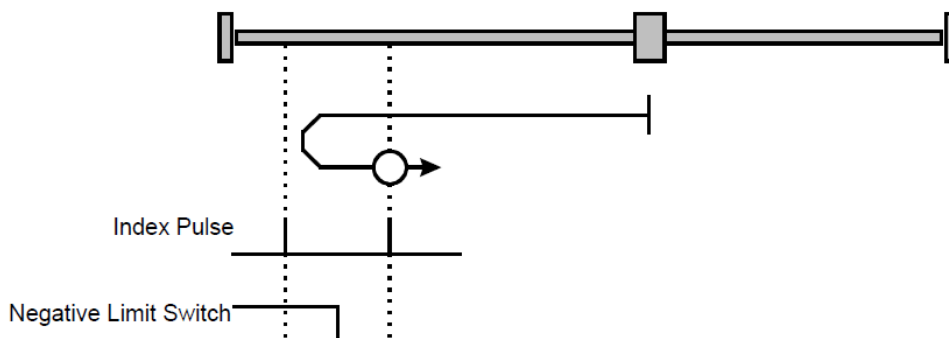

Figure 4.8: Proximity homing: negative direction + zero encoder.

In this mode, the motor searches for the zero proximity in the negative direction of the movement, with the velocity set to "homing speed search". As soon as the proximity is detected, the motor stops and exits the proximity, in the opposite direction, with the velocity set to "homing speed out", until it finds the zero encoder. If the proximity is already detected on the start of the homing procedure, the motion will start with the "homing speed out" phase. If the proximity is surpassed because of the inadequate speed / deceleration combination, the homing procedure is interrupted and a homing error is returned.

4.1 Fieldbus Modes

4.1.5.5 Proximity homing: positive direction + zero encoder

Proximity search in positive direction and then search for the index pulse (zero of the encoder) in the negative direction (refer to Figure 4.9).

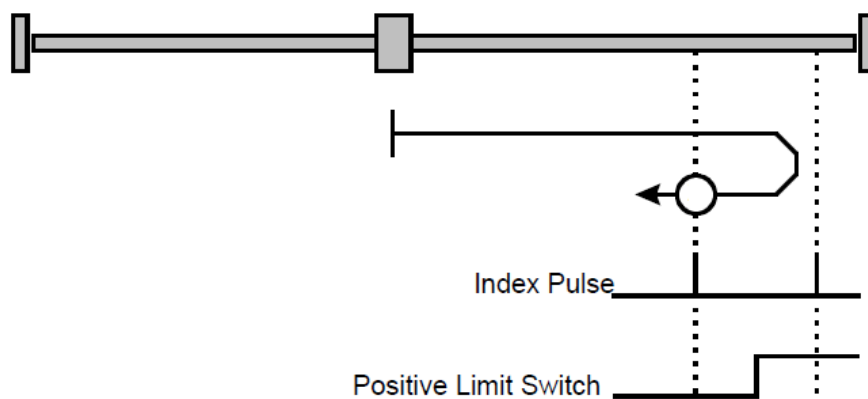

Figure 4.9: Proximity homing: positive direction + zero encoder.

In this mode, the motor searches for the zero proximity in the positive direction of the movement, with the velocity set to "homing speed search". As soon as the proximity is detected, the motor stops and exits the proximity, in the opposite direction, with the velocity set to "homing speed out", until it finds the zero encoder. If the proximity is already detected on the start of the homing procedure, the motion will start with the "homing speed out" phase. If the proximity is surpassed because of the inadequate speed / deceleration combination, the homing procedure is interrupted and a homing error is returned.

4.1.5.6 Torque homing: negative direction

Homing torque in negative direction (refer to Figure 4.10). In this mode the motor rotates in the neg-

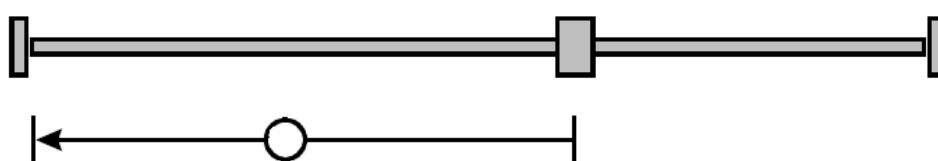

Figure 4.10: Torque homing: negative direction.

ative direction of the movement, with the velocity set to "homing speed search", until it stops against the end of the line and the I^2T reaches the homing set value.

4.1.5.7 Torque homing: positive direction

Homing torque in positive direction (refer to Figure 4.11). In this mode the motor rotates in the positive direction of the movement, with the velocity set to "homing speed search", until it stops against the end of the line and the I^2T reaches the homing set value.

4.1 Fieldbus Modes

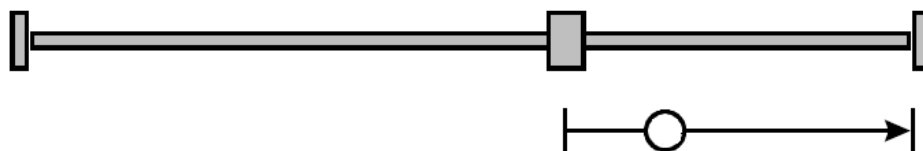

Figure 4.11: Torque homing: positive direction.

4.1.5.8 Torque homing: negative direction + zero encoder

Homing torque in negative direction and then search for the index pulse (zero of the encoder) in the positive direction (refer to Figure 4.12).

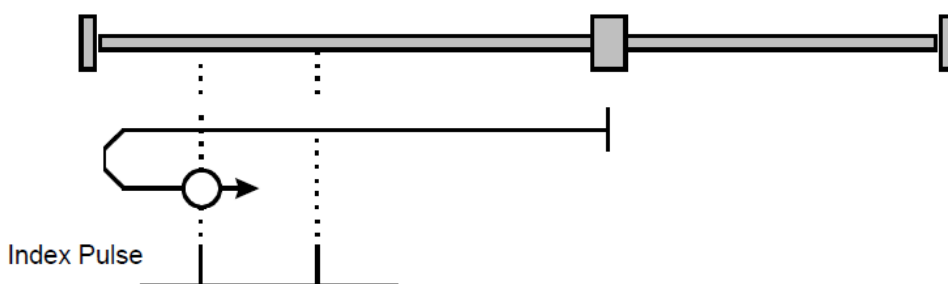

Figure 4.12: Torque homing: negative direction + zero encoder.

In this mode the motor rotates in the negative direction of the movement, with the velocity set to "homing speed search", until it stops against the end of the line and the I^2T reaches the homing set value. At this point the motor rotates in the opposite direction, with the velocity set to "homing speed out", until it finds the zero encoder.

4.1.5.9 Torque homing: positive direction + zero encoder

Homing torque in positive direction and then search for the index pulse (zero of the encoder) in the negative direction (refer to Figure 4.13).

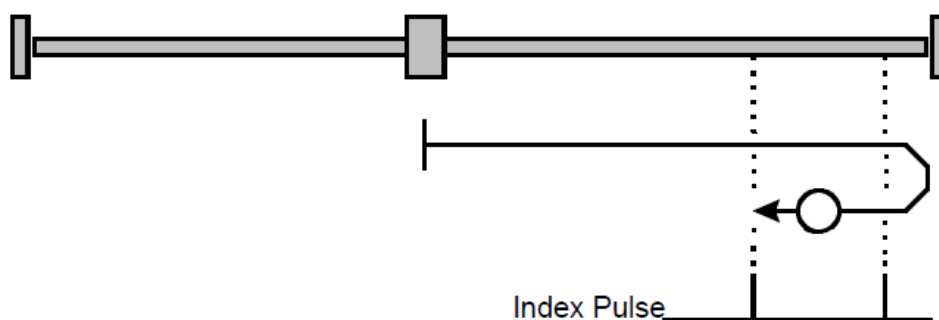

Figure 4.13: Torque homing: positive direction + zero encoder.

In this mode the motor rotates in the positive direction of the movement, with the velocity set to "homing speed search", until it stops against the end of the line and the I^2T reaches the homing set value. At this point the motor rotates in the opposite direction, with the velocity set to "homing speed out", until it finds the zero encoder.

4.1 Fieldbus Modes

4.1.5.10 Homing offset

The Homing offset indicates the configured difference between the **zero position** for the application and the machine **home position** (found during homing). During homing the motor moves to search the home position: it is possible to change the zero position, that by default is set at the same value of the home position, by adding an offset to the home position. This value could be positive or negative and all subsequent absolute movements shall be taken relative to this new zero position.

4.2 Digital Input mode

4.2 Digital Input mode

The drive can be configured to be moved only using digital input signals. This functionality excludes the fieldbus and the motor can be moved in speed mode using only digital input.

The UVIX application must be used to set and enable the Digital Input mode and to set and store in non-volatile memory the specific parameters of this mode (see Figure 7.10). After these operations, the drive must be rebooted (turn OFF and ON the VL logic power supply) to apply the configuration.

Referring to Table 3.6 in Digital Input mode IN FW and IN BW are used to decide the direction of the movement, FRONT PROXY and REAR PROXY can be used as limits of the range of movement and the only output OUT ERR can be used to detect errors.

4.2.1 Application example

Assuming the DRVI is connected at cylinder, the proximities REAR PROXY and FRONT PROXY must be mounted in two extreme positions of the cylinder: backward and forward as shown in figure 4.14.

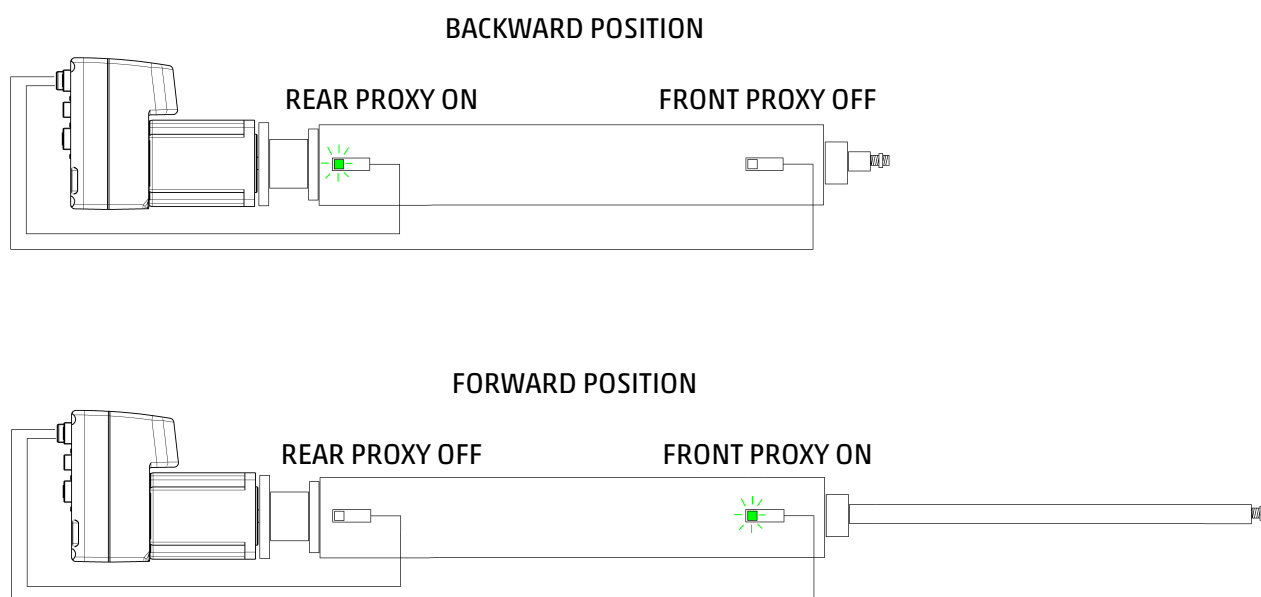

Figure 4.14: Extreme positions of cylinder.

⚠ Each proximity sensor is linked to one single positions, be careful not reverse them.

The input IN FW and IN BW are used to command forward or backward movement respectively.

4.2 Digital Input mode

4.2.2 Functioning

Logic functioning is guaranteed by state machine, a simplified version is shown in figure 4.15.

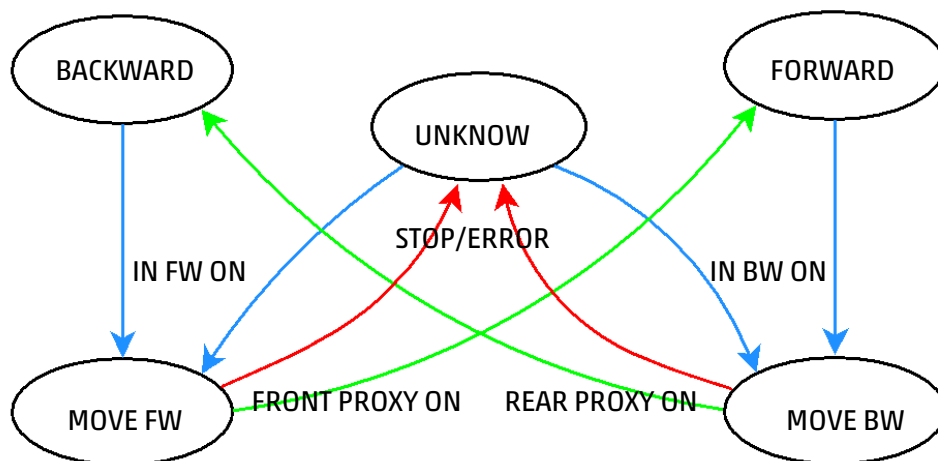

Figure 4.15: Simplified State Machine.

When device starts proximities are tested to know the position. Depending on the status of the proxies device can start in BACKWARD, UNKNOW or FORWARD state. In these three states the drive wait the rise of IN FW or IN BW to start the movement. When the movement ends by stop or error drive goes in UNKNOW state, otherwise if proxy is reached drive goes in BACKWARD or FORWARD state.

The movement is stopped when:

- IN FW and IN BW are both low and self-holding is disabled
- REAR PROXY or FRONT PROXY is reached
- drive error occurs

▲ Self-holding of input IN FW and IN BW can be enabled using UVIX (see Figure 7.20)

Figures 4.16 and 4.17 show combinations of signals for two different self-holding settings.

4.2 Digital Input mode

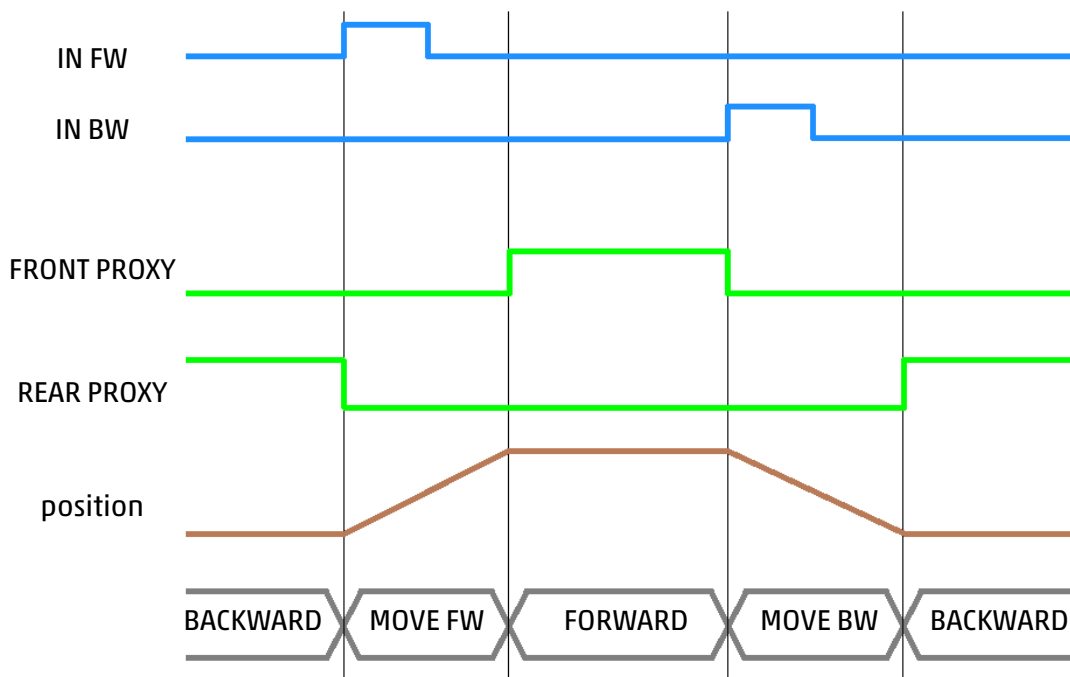

Figure 4.16: Signal combination example with self-holding enabled.

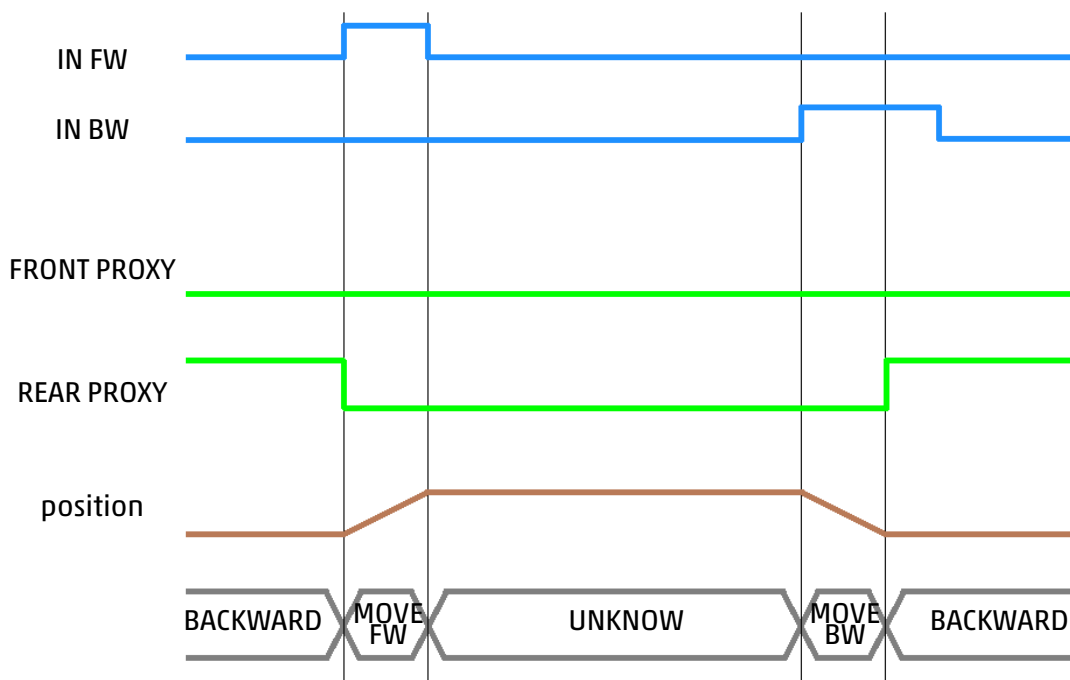

Figure 4.17: Signal combination example with self-holding disabled.

4.2 Digital Input mode

4.2.3 Self-holding with positioning

To achieve better performance is possible to use position control instead speed control (configurable with UVIX, see Figure 7.20). Normally in Digital Input mode the device is controlled in speed and start braking when the proxy turns on. High speed and low deceleration may cause a proximity lost error 4.2.5. With position control, the device always knows where it is and can decelerate before reaching the proximity. For this reason, *Self-holding with positioning* improves performance: it's possible to increasing speed and ensuring greater precision in reaching the position.

▲ *Self-holding with positioning* requires a learning procedure (a sort of "double homing"): the first two movements are performed at a reduced speed with the aim of memorising the positions of the two proximities. This speed is called *Jog Speed search* (and it is configurable with UVIX, see Figure 7.21). This procedure must be repeated at each start-up, only if the device has been moved while it was off.

4.2.4 Error handler

When a drive error occur the movement is stopped and OUT ERR is reversed (only if not in manual mode). Reset error is possible by raising both input IN FW and IN BW, if error can be resetted OUT ERR return to previous logic state and the device turn servo ON.

4.2 Digital Input mode

4.2.5 Proximity lost error

The proximity lost error makes the SYS led blinking 4 times, according to table 3.11. This error should never occur using recommended values of acceleration deceleration and speed. When movements are fast with low deceleration, proximity may switch before drive stops. In other words the drive is unable to stop into the proximity's sensitivity zone, like shown in Figure 4.18.

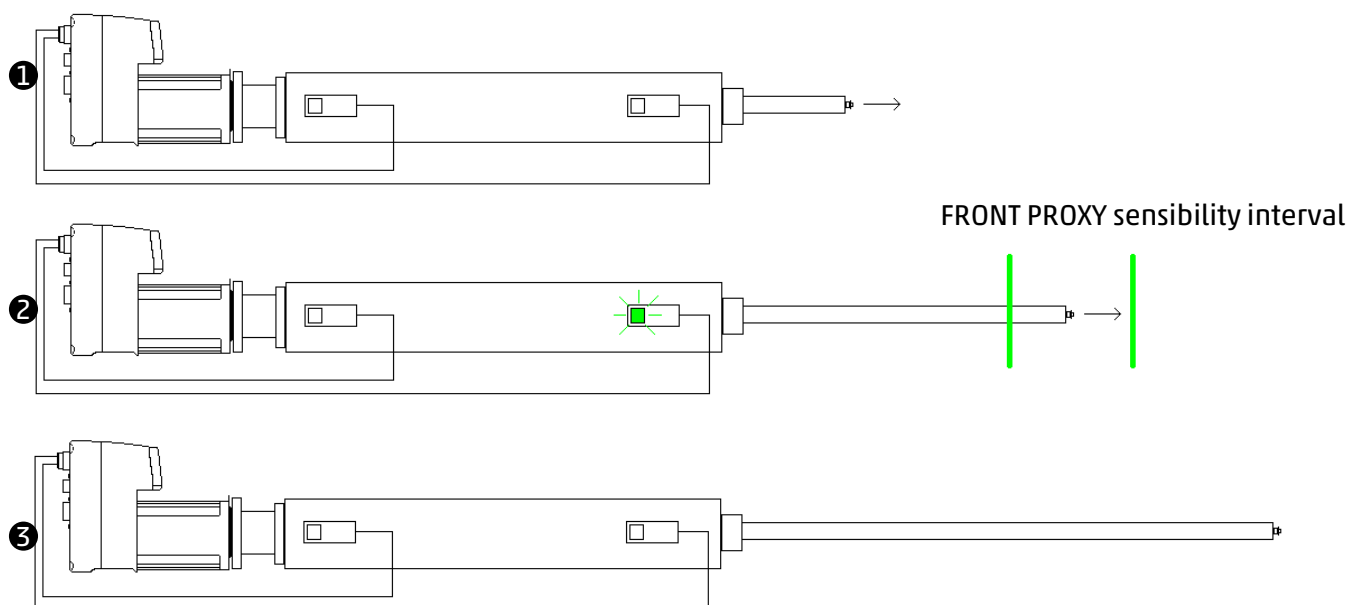

Figure 4.18: Example of proximity lost error:

- ❶ cylinder moving forward unless find proximity;
- ❷ FRONT PROXY turn on, so the drive starts to brake;
- ❸ FRONT PROXY turned off before drive end to brake: proximity lost.

The proxy lost error is handled differently than other drive errors. Also in this case is necessary to raising both input IN FW and IN BW to reset error, after reset the drive moves in the opposite direction to re-find the proximity (using custom values of acceleration, deceleration and velocity).

Other features

In this chapter are described other features that can be used in combination with the various modes of operation.

5.0.1 Profile software limits

Profile software limits can be set to restrict the motion parameters (positions, speed, acceleration and deceleration) to a desired value.

Such limits can be configured using the UVIX interface (refer to Section 7.5.1) and are valid for all the configurations different from "only motor" and for all the modes of operation.

Software limits take effect only after homing execution and if the corresponding "software limits enable" in the protocol is set (refer to Chapter 6 controlword bit6). In case a position software limit error is triggered (for example the servo has been set momentary OFF and the motor has been moved beyond the software position limit or the EXT PROXY INPUT signal has been caught), the drive, if it was moving, stops itself using the QUICK_STOP that is the deceleration parameter set in UVIX (refer to Section 7.5.2) and it goes into error state and the correspondent error is raised on the fieldbus. In such situation, to bring back the motor into the allowed position range, the error must be reset first (the red error led goes off for a little time and then blinks again because the motor is still in a error position) and then restore the servo on . Then, even if the red error led blinks, it is allowed to move the motor using any of the mode of operations (even if it is still out of the allowed range, because the software limit check will be momentary disabled). The error check on positioning will be restored automatically after the first movement completion (target position for positioning control or zero speed for speed control), provided that the "software limit enable" is still set. When the motor is moved and return inside the allowed stroke range values, it is possible to clear the error sending the reset error command for 2 times.

Regarding target position, target speed, acceleration and deceleration values, if their target values exceed the limit value, the set is inhibited, that is, the parameter is not applied (the previous valid parameter remains valid) and the "command refused" warning is raised.

Profile position hardware limit: The position limit feature of Section 5.0.1 can be achieved also using a proximity sensor connected to the EXT PROXY INPUT (refer to Section 3.3.2). As soon as the EXT PROXY INPUT goes to HIGH state, the drive behaves as described in Section 5.0.1. Note that the hardware limit takes effect only if the "software limits enable" in the protocol is set.

5.0.2 Torque limit

Torque limitation is a feature that allows to limit the torque (current) supplied by the motor. This feature can be enabled and disabled using the provided "torque limit enable" in the protocol (refer to Chapter 6, controlword bit7).) and it takes effect for all the modes of operation. The current limit value is configured using the fieldbus interface and it can be changed in real-time using the Target torque

parameter(refer to Chapter 6).

5.0.3 Save and restore actual position

From firmware version 2.07 has been added the management that can save and restore the actual position: in case the DRVI has already executed and completed successfully an homing procedure and the motor is stopped, if the power supply goes OFF, the DRVI try to save the information about the actual position and next time power supply is turned ON, check if the actual encoder position is the same that has been saved at shutdown (with a small tolerance) and in this case restore the position. With this procedure it should not be necessary to do the homing procedure every time you turn it on and motor can continue from the situation at shutdown.

EtherNet/IP Protocol

This Chapter describes how to configure and control the drive with a EtherNet/IP PLC.

6.1 Conventions

In this Section is given a description about the conventions used in this manual.

The data types used are shown in Table 6.1:

Table 6.1: Data types.

Name	Size
S32	32 bit signed
U32	32 bit unsigned
S16	16 bit signed
U16	16 bit unsigned
S8	8 bit signed
U8	8 bit unsigned
STR	string

In Table 6.2 are shown the units of measurement used by the drive.

Table 6.2: Units of measurement.

Quantity	Unit
Position	Degrees · 100 (*)
	mm · 100 (**)
Speed	RPM (*)
	mm / s (**)
Acceleration	RPM / s (*)
	mm / s ² (**)
	mA / s (***)
Deceleration	RPM / s (*)
	mm / s ² (**)
	mA / s (***)
Torque (current)	mA

(*) Used when the drive is configured as "only motor".

(**) Used in all other configurations different from "only motor".

(***) Used in torque (current) control.

A positive position or a positive speed target cause the motor shaft to rotate in a clockwise direction, when the motor shaft is viewed from the front. Example: a position target of 36000, when the drive is configured as "only motor", corresponds to one turn of the shaft in a clockwise direction.

6.2 Startup parameters

In Table 6.3 are listed the parameters that are sent by the PLC to the drive at the startup.

If the option "Stored Parameters" of "System Start" parameter is selected, the drive will load the startup parameters stored in internal memory, instead if the option "External" is used, the drive will use the parameters sent by the PLC. All the parameters are stored in non volatile memory upon variation.

The "Endianness" parameter allows to set the endianness of the communication between the PLC and the drive.

The "PID Selection" parameter provides five different presets for speed and position PID controllers, that can be selected according to the specific application. For particular needs, the "PID Custom" configuration can be used and in this case, PID speed and position can be tuned using "PID Position" and "PID Speed" parameters. It is suggested to use the "Default" PID configuration when the drive has little or no load attached. Use instead the other presets, according to the entity of the load attached to the shaft.

The "Profile Check" parameter allows to control if the target speed (when in speed control) or the target position and speed (when in position control) are actually reached by the motor, during the motion execution. The "Profile Timeout" parameter, expressed in milliseconds, is the time after which the error is returned, in case target position or target speed are not reached.

Target scale factor "Numerator" and "Denominator" allow to apply a scaling to the profile parameters (i.e.: final targets are multiplied by "Numerator" and divided by "Denominator").

The "Motion direction" parameter allows to set the motor movement positive direction, clockwise or counterclockwise.

The "Actuator screw pitch" defines the value in mm that the axis moves for each motor revolution.

The "Homing parameters" allows to set the Homing speeds (fast and slow) and the acceleration (regarding it, in case of using the startup parameters by PLC, the value is unique for all homing accelerations In and Out, whilst using UVIX is possible to set 4 different values).

6.3 Cyclic data

Table 6.3: Startup parameters.

Parameter	Description	Options
Endianness	Data format used	Little Endian (INTEL) Big Endian (MOTOROLA)
System Start	Startup parameters to use	Stored Parameters External
PID Selection		Default Low load Medium load High load Custom
PID position	Valid for Custom PID selection	KP Position KI Position
PID speed	Valid for Custom PID selection	KP Speed KI Speed
Profile	Control target speed / position reached	Check Timeout (ms)
Target scale factor	Scale factor applied to speed / position / acc / dec	Numerator Denominator
Motion direction	Set the motor rotation direction	clockwise counterclockwise
Actuator screw pitch		mm/motor revolution
Torque homing threshold	Torque limit during the homings	% of the I ² T limit value
Actuator type		Only motor Custom Actuator
Homing parameters		Fast speed Slow speed acceleration/deceleration

6.3 Cyclic data

In Table 6.4 and Table 6.5 are shown the cyclic data exchanged between the drive and the PLC.

6.3 Cyclic data

Table 6.4: Data input (from PLC to drive).

Offset	Variables	Type	Description
0	CTRL_WORD	WORD	Control word
2	MODE_OPERATION	WORD	Mode operation
4	OUTPUT_GPIO	WORD	Output GPIO
6	TARGET_POS	DINT	Target position
10	TARGET_SPEED	DINT	Target speed
14	TARGET_ACC	WORD	Target acceleration
16	TARGET_DEC	WORD	Target deceleration
18	TARGET_TORQUE	INT	Target torque

Table 6.5: Data output (from drive to PLC).

Offset	Variables	Type	Description
0	STATUS_WORD	WORD	Status word
2	ACTUAL_MODE_OPERATION	WORD	Mode operation state
4	DIAGNOSTIC_WORD	DWORD	Diagnostic word
8	ACTUAL_SPEED	DINT	Actual speed
12	ACTUAL_POS	DINT	Actual position
16	ACTUAL_TORQUE	INT	Actual torque (current)
18	INPUTS	WORD	Inputs GPIOs status

6.3.1 Control word

The drive states are changed by means of the CONTROL_WORD variable. Following is given a description of its bitfield:

6.3 Cyclic data

Table 6.6: Control word.

Bit	Value	State	Description
0	0	SERVO_OFF	Control disabled (idle)
	1	SERVO_ON	Control enabled
1	0		Inhibit target changes
	1	START_MOV	Allow target changes in SPEED and TORQUE mode
	\uparrow	START_MOV	Start movement for POS_REL and POS_ABS Enable a change in MODE_OPERATION
2	\uparrow	HALT	Motion stop
3	\uparrow	QUICK_STOP	Motion quick stop
4	\uparrow	RES_ERR	Reset errors and warnings
5	-	-	(not used)
6	0	SWLIM	Software limits disabled
	1		Software limits enabled
7	0	TORQUE_LIM	Torque limitation disabled
	1		Torque limitation enabled
8	0	JOG_LEFT	JOG left disabled
	1		JOG left enabled
9	0	JOG_RIGHT	JOG right disabled
	1		JOG right enabled

The \uparrow symbol means that the action is taken upon the transition from 0 to 1 of the respective bit. The transition from 0 to 1 of the START_MOV bit has the effect of:

- Enable the movement and load the profile parameters for POS_REL and POS_ABS mode operations.
- Applies a change of MODE_OPERATION.

In SPEED and TORQUE operation mode, the START_MOV bit has the effect of global enable. For example, if START_MOV bit is set, a change of target (e.g.: TARGET_SPEED) has immediate effect. Instead, if the START_MOV bit is reset, parameters changes are ignored. Note that in POS_REL and POS_ABS operation mode, to start the movement and load the profile parameters, the START_MOV bit have to make a transition from 0 to 1.

The HALT command causes the actual movement to stop, using as deceleration value the TARGET_DEC value taken from the data input.

The QUICK_STOP command causes the actual movement to stop, using as deceleration value the correspondent parameter configured with UVIX (see Paragraph 7.5.2).

The SWLIM bit enables or disables the actuator software limits configured with UVIX (see Paragraph 7.5.1).

The TORQUE_LIM bit enables or disables the torque (current) limitation feature (see Paragraph 5.0.2).

The limit current value is the one taken from the cyclic data variable TARGET_TORQUE. Hence, for example, if TARGET_TORQUE = 1000 is set, the drive current will be limited to 1 Ampere, in all the modes of operation.

The JOG_LEFT and JOG_RIGHT bits allow to control the JOG mode according to the truth Table 6.8. Notice that these bits work only when the drive is in JOG mode operation.

6.3 Cyclic data

6.3.2 Mode operation

The drive modes of operation are changed by means of the MODE_OPERATION variable. To execute any of the mode operation states, the SERVO_ON bit must be set first, while mode operation value is NONE. In Table 6.7 is given the correspondence between the MODE_OPERATION value and the modes of operation described in Chapter 4.

Table 6.7: Modes of operation.

Value	Label	Mode of operation
0	NONE	
1	SPEED	Speed
2	POS_REL	Positioning relative
3	POS_ABS	Positioning absolute
4	TORQUE	Torque
5	HOMING_0	Positioning homing
6	HOMING_1	Proximity homing: negative direction
7	HOMING_2	Proximity homing: positive direction
8	HOMING_3	Proximity homing: negative direction + zero encoder
9	HOMING_4	Proximity homing: positive direction + zero encoder
10	HOMING_5	Torque homing: negative direction
11	HOMING_6	Torque homing: positive direction
12	HOMING_7	Torque homing: negative direction + zero encoder
13	HOMING_8	Torque homing: positive direction + zero encoder
14	JOG	Jog

A mode operation change takes effect immediately, provided that the operation is allowed, but the new target execution takes effect on the transition from 0 to 1 of the START_MOV bit. To switch from different mode operations, the drive must first be stop (zero speed for speed or torque control and stop position in positioning control), otherwise the change of command will be discarded and the "command refused" bit of the warning word will be set.

6.3.2.1 NONE

This is the mode operation present at the first drive startup (servo off).

6.3.2.2 SPEED

In SPEED operation it is mandatory first to set a TARGET_ACC and a TARGET_DEC value different from zero, before setting the START_MOV bit, otherwise the "command refused" warning is returned. To enable speed operation, the START_MOV bit of the control word must be set to "1". Consecutive speed targets can be given, also interrupting an executing target, provided that the START_MOV bit is high.

6.3 Cyclic data

6.3.2.3 POS_REL, POS_ABS

In POS_REL or POS_ABS operations it is mandatory first to set a SPEED, TARGET_ACC and a TARGET_DEC value, different from zero, before setting the START_MOV bit, otherwise the "command refused" warning is returned. To enable this operation, the START_MOV bit of the control word must make a transition from "0" to "1". It is possible to execute a new target, or change the current target during a movement, as long as a new rising edge of the start bit is provided.

6.3.2.4 TORQUE

In TORQUE operation it is mandatory first to set a TARGET_ACC and a TARGET_DEC value different from zero, before setting the START_MOV bit, otherwise the "command refused" warning is returned. To enable speed operation, the START_MOV bit of the control word must be set to "1". Consecutive torque (current) targets can be given, also interrupting an executing target, provided that the START_MOV bit is high.

6.3.2.5 HOMING_0, ... HOMING_8

Homing parameters such as speeds, accelerations decelerations and so on, can be set and stored in the drive memory using the UVIX interface (refer to Section 7.6.1.4), although the default stored parameters should be fine for most of the user applications. If needed, an offset can be added to the homing position: in such case, after homing execution, the drive will display such value as current position, instead of zero. In torque homing the drive will rotate at constant speed, until it stops against an obstacle. The homing position will be detected when the I²T value will reach the established set-point. To enable HOMING operation (i.e.: starting homing execution), the start bit of the control word, must make a transition from "0" to "1".

6.3.2.6 JOG

In POS_REL or POS_ABS operations it is mandatory first to set a SPEED, TARGET_ACC and a TARGET_DEC value, different from zero, before using the JOG_LEFT and JOG_RIGHT bits. In this operation mode the START_MOV bit is ignored. The motion is controlled using the JOG_LEFT and JOG_RIGHT bits of the controlword, according to the states in Table 6.8.

Table 6.8: Control word - Jog truth table.

Bit 9	Bit 8	Definition
0	0	Stop (zero speed)
1	0	Clockwise rotation
0	1	Counter-clockwise rotation
1	1	Invalid command (previous state persists)

6.3.3 Output GPIO

The OUTPUT_GPIO variable allows the control of the output located on the I/O connector (refer to Section 3.3.2). The output state changes according to the values in Table 6.9.

6.3 Cyclic data

Table 6.9: Output GPIO bitmask.

Bit	Value	Description
0	0	OUT LOW
	1	OUT HIGH

6.3.4 Target position

The TARGET_POS variable allows to set the target position used by POS_REL and POS_ABS operation modes. Target position must be given in cents of degrees or cents of mm and the unit of measurement depends upon the drive configuration (refer to the Paragraph 6.1). The sign of the variable establishes the direction of the movement.

6.3.5 Target speed

The TARGET_SPEED variable allows to set the target speed used by SPEED, POS_REL and POS_ABS operation modes. Target speed must be given in cents of RPM or cents of mm / s and the unit of measurement depends upon the drive configuration (refer to the Paragraph 6.1). The sign of the variable establishes the rotation direction for SPEED mode operation. In POS_REL and POS_ABS operations, instead, its absolute value is considered.

6.3.6 Target acceleration

The TARGET_ACC variable allows to set the target acceleration used by SPEED, POS_REL, POS_ABS and TORQUE modes of operation. Target acceleration must be given in RPM / s or mm / s² or mA / s and the unit of measurement depends upon the drive configuration (refer to the Paragraph 6.1). In TORQUE operation mode this parameter takes the meaning of "positive torque slope".

6.3.7 Target deceleration

The TARGET_DEC variable allows to set the target deceleration used by SPEED, POS_REL, POS_ABS and TORQUE modes of operation. Target deceleration must be given in RPM / s or mm / s² or mA / s and the unit of measurement depends upon the drive configuration (refer to the Paragraph 6.1). In TORQUE operation mode this parameter takes the meaning of "negative torque slope".

6.3.8 Target torque

The TARGET_TORQUE variable allows to set the target torque used by TORQUE mode of operation. Target torque must be given in mA (refer to the Paragraph 6.1).

6.3.9 Status word

The drive states are monitored by means of the STATUS_WORD variable. In Table 6.10 is given a description of its bitfield.

6.3 Cyclic data

Table 6.10: Status word.

Bit	Value	State	Description
0	0	SERVO_ON	Servo OFF (control disabled)
	1		Servo ON (control enabled)
1	0	BUSY	Drive ready to receive target
	1		Drive executing target
2	0	TARGET_REACHED	Profile executing
	1		Target has been reached
3	0	ERRORS	No errors or warnings present
	1		Errors or warnings present
4	0	HOMING_DONE	Homing missing
	1		Homing done
5	0	MANUAL_MODE	UVIX manual mode enabled
	1		UVIX manual mode disabled
6	0	SWLIM	Software limits disabled
	1		Software limits enabled
7	0	TORQUE_LIM	Torque limitation disabled
	1		Torque limitation enabled
8	0	JOG_LEFT	JOG left disabled
	1		JOG left enabled
9	0	JOG_RIGHT	JOG right disabled
	1		JOG right enabled

6.3.10 Actual mode operation

The ACTUAL_MODE_OPERATION variable returns the actual value of the MODE_OPERATION variable. After a HALT or a QUICK_STOP command, the drive remains in SPEED mode (with target speed 0 RPM or mm / s), if the previous MODE_OPERATION was SPEED or TORQUE and it remains in POS_REL, if the previous MODE_OPERATION was POS_REL or POS_ABS. After a SERVO_ON command, at the startup, the ACTUAL_MODE_OPERATION is POS_ABS.

6.3.11 Diagnostic word

The DIAGNOSTIC_WORD variable returns the state of both errors and warnings. The difference between the two is that warnings do not impact on the drive operation (they are just signaled), while errors cause the motor to stop. Both errors and warnings remain latched even if the error or warning condition disappear. To reset warning and error conditions, the reset command RES_ERR must be given (see Table 6.6). After the error reset the drive is in SERVO_OFF state, hence another SERVO_ON must be given to start movements. The only warnings that auto-reset are the "homing missing" and the "command refused" ones. Errors are divided into two categories: hard and soft. Soft errors are considered less severe and they cause a controlled stop of the motor rotation by triggering the command QUICK_STOP.

6.3 Cyclic data

Soft errors are:

- Temperature motor limit
- Temperature drive limit
- Fieldbus disconnection

All the others are hard errors and they cause the power drives to be turned off, hence the motor finishes its rotation in idle state, that is, with no control applied. In Table 6.11 is shown the bit-field of the diagnostic word: the upper 16 bits represent the errors, while the lower 16 bits represent the warnings.

Table 6.11: Diagnostic word description.

Bit	Warnings
0	VDC UVLO (< 20V)
1	VDC OVLO (> 60V)
2	VL UVLO (< 21V)
3	VL OVLO (> 27V)
4	Temperature motor limit (> 75°C)
5	Temperature drive limit (> 75°C)
6	Calibration not done
7	RESERVED
8	Homing missing
9	Target speed not reached
10	Target position not reached
11	Command refused
12 ... 15	RESERVED
Bit	Errors
16	VDC UVLO (< 10V)
17	VDC OVLO (> 80V)
18	VL UVLO (< 16V)
19	VL OVLO (> 29V)
20	Temperature motor limit (> 100°C)
21	Temperature drive limit (> 100°C)
22	Current sensors fault
23	Control fault
24	Encoder fault
25	Non volatile memory fault
26	I ² T fault
27	STO
28	Homing execution error
29	Software limits error
30 ... 31	RESERVED

NOTE: Temperature warnings don't affect the drive functionality, but they indicate the hot surface of the motor and/or the drive.

6.4 Acyclic data

6.3.12 Actual speed

The ACTUAL_SPEED variable returns the value of the actual speed of the motor. The unit of measurement depends upon the drive configuration (refer to the Paragraph 6.1).

6.3.13 Actual pos

The ACTUAL_POS variable returns the absolute value of the motor position. The unit of measurement depends upon the drive configuration (refer to the Paragraph 6.1).

6.3.14 Actual torque

The ACTUAL_TORQUE variable returns the value of the control current of the motor. The unit of measurement depends upon the drive configuration (refer to the Paragraph 6.1).

6.3.15 Inputs

The INPUTS variable returns the states of the input GPIOs present on the I/O connector (refer to Section 3.3.2), according to the bitmask described in Table 6.12. A "0" value indicates an input LOW state while a "1" value indicates an input HIGH state.

Table 6.12: Input GPIO bitmask.

Bit	Description
0	IN1
1	IN2
2	EXT PROXY INPUT
3	PROXY INPUT

6.4 Acyclic data

In addition to the data periodically exchanged between master (e.g.: PLC or PC) and DRVI, is available a set of parameters that, if necessary, can be modified acyclically. In Table 6.13 are listed the managed parameters.

Table 6.13: Acyclic parameters.

ID	Sub	Description	Type	Access	PDO Mapping	Default Value
6040h	0	Controlword	U16	RW	yes	0
6041h	0	Statusword	U16	RO	yes	0
6060h	0	Mode of operation	S8	RW	yes	0
6061h	0	Mode of operation display	S8	RO	yes	0
6064h	0	Position Actual Value	S32	RO	yes	0
606Ch	0	Velocity Actual Value	S32	RO	yes	0
6071h	0	Target torque	S16	RW	yes	0

Continued on next page.

6.4 Acyclic data

Table 6.13 – Continued from previous page.

ID	Sub	Description	Type	Access	Cyclic	Default Value
6077h	0	Torque actual value	S16	RO		0
607Ah	0	Target position	S32	RW	yes	0
607Ch	0	Home offset	S32	RW		0
607Eh	0	Polarity	U8	RW		0
6081h	0	Target Velocity	U32	RW	yes	0
6083h	0	Profile Acceleration	U32	RW	yes	0
6084h	0	Profile Deceleration	U32	RW	yes	0
6087h	0	Torque slope	U32	RW		0
6099h		Homing Speeds				
	1	Fast Homing Speed	U32	RW		0
	2	Slow Homing Speed	U32	RW		0
609Ah	0	Homing acceleration	U32	RW		0

6.4.1 Acyclic parameters descriptions

In the following Sections are described the acyclic parameters.

6.4.1.1 6040h Controlword

For object description refer to Section [6.3.1](#).

6.4.1.2 6041h Statusword

For object description refer to Section [6.3.9](#).

6.4.1.3 6060h Mode of operation

For object description refer to Section [6.3.2](#).

6.4.1.4 6061h Mode of operation display

For object description refer to Section [6.3.10](#).

6.4.1.5 6064h Position actual value

For object description refer to Section [6.3.13](#).

6.4.1.6 606Ch Velocity actual value

For object description refer to Section [6.3.12](#).

6.4.1.7 6071h Target torque

For object description refer to Section [6.3.8](#).

6.4 Acyclic data

6.4.1.8 6077h Torque actual value

For object description refer to Section 6.3.14.

6.4.1.9 607Ah Target position

For object description refer to Section 6.3.4.

6.4.1.10 607Ch Home offset

This object contains the offset to apply to the physical zero position (imposed by the proximity position) to obtain the zero position of the motor. The drive execute the homing procedure requested (stop on switch, stop on zero encoder, stop on current threshold, etc.) and when it is finished, it sets the actual position to the offset value.

6.4.1.11 607Eh Polarity

This object allows the motor rotation direction to be reversed, in order to change the movement direction, according to the physical mounting of the motor. Setting bit 7 reverses the rotation direction.

NOTE: this parameter has an impact to ALL the mode of operation (homings, positioning, speed, torque)

Table 6.14: Polarity values.

Value	Direction
0x00	Forward
0x80	Reverse

6.4.1.12 6081h Target Velocity

For object description refer to Section 6.3.5.

6.4.1.13 6083h Profile acceleration

For object description refer to Section 6.3.6.

6.4.1.14 6084h Profile deceleration

For object description refer to Section 6.3.7.

6.4.1.15 6087h Torque slope

This object shall indicate the configured rate of change of torque (current). The value shall be given in units of per thousand of rated torque (current) per second.

6.4 Acyclic data

6.4.1.16 6099h Homing speeds

This object contains the speed values used during the zero procedure.

- Fast homing speed = speed used to search for the zero proximity.
- Slow homing speed = speed used to start from the zero proximity and to find the index pulse.

6.4.1.17 609Ah Homing acceleration

This object shall indicate the configured acceleration and deceleration to be used during homing operation.

Uvix

7.1 Introduction

Camozzi's proprietary environment, called UVIX, allows the user to monitor and configure all new generation Camozzi devices (*Camozzi Smart Devices*) that support connection to it. Devices can be connected to UVIX via USB or Ethernet (see [7.8.2](#)). This system has been implemented with a web-based architecture so that information can be accessed straightforwardly using a browser. Monitoring consists of displaying all the device variables, whether they relate to operation, diagnostics, or parameterization. For details on the UVIX architecture, its installation, and general operations, see the [UVIX Manual](#).

7.2 General information

7.2 General information

The devices connected to the UVIX are displayed in a tree diagram **1** consisting of *Device Groups*, *Family* and *Devices*. Select one of the components to view in the main window **2** all the information on the various devices and perform configuration operations or manual commands.

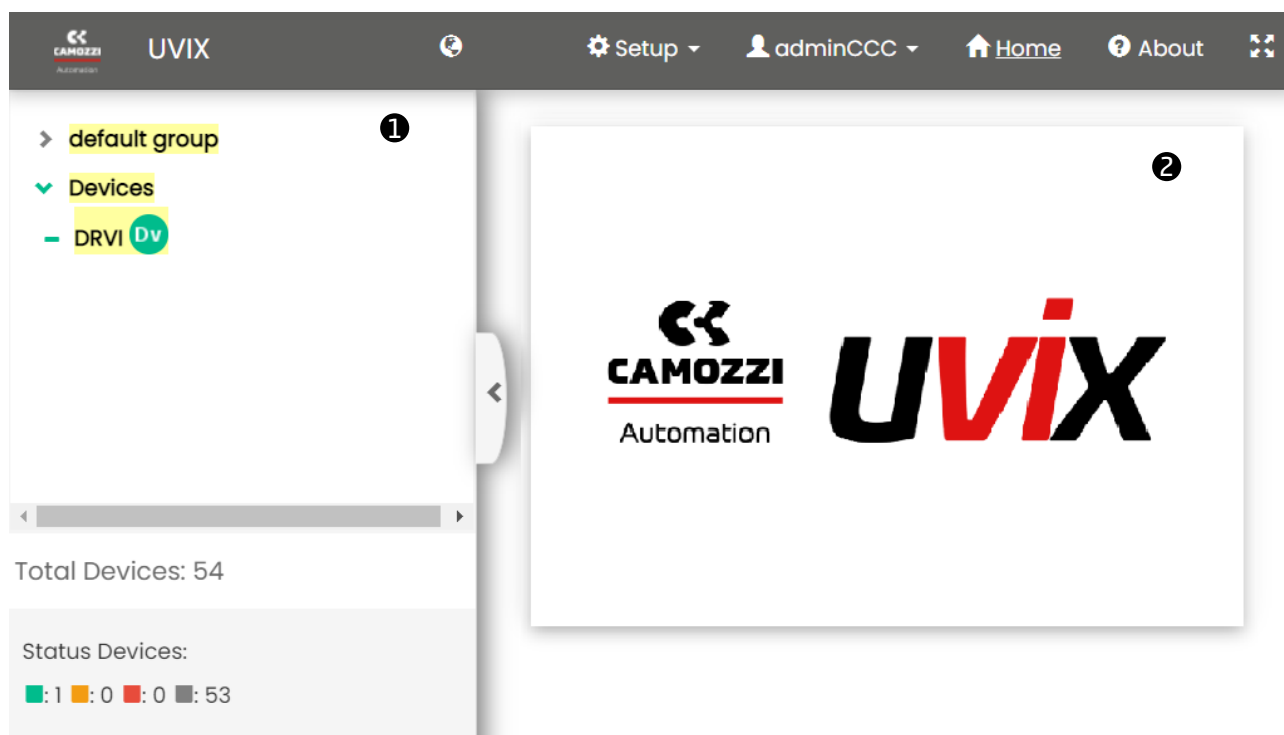

Figure 7.1: Main page of the UVIX interface.

Select the DRVI device to view the general status information [7.3](#) and details [7.4](#). Furthermore, it is possible to set the DRVI parameters and to communicate with the device in real-time (*Commissioning*).

7.3 Status information

7.3 Status information

- ① Image of the DRVI series.
- ② Assigned name of the device.
- ③ Identification number of the device (17 chars).
- ④ Family name of the device: *Series Integrated Foc Drive*.
- ⑤ Subtype of the device family: *Stepper/BLDC* and *Nema23/Nema24*.
- ⑥ Firmware version.
- ⑦ Date and time of the last data transmission.
- ⑧ General status of the device: ● Not available, ● Ok, ● Warning, ● Alarm.
- ⑨ Operational status of the device:
 - *Work*: normal operation.
 - *Manual*: manual operation.
- ⑩ Connection status: ● Ok, ● Offline.
- ⑪ Fieldbus communication: Profinet/EtherCAT/CANopen.
- ⑫ Communication status of the Fieldbus: ● Ok, ● Offline.
- ⑬ Fieldbus configuration.
- ⑭ DRVI parameters configuration (par. 7.5).
- ⑮ Commissioning device (par. 7.6).

Status information: ▼

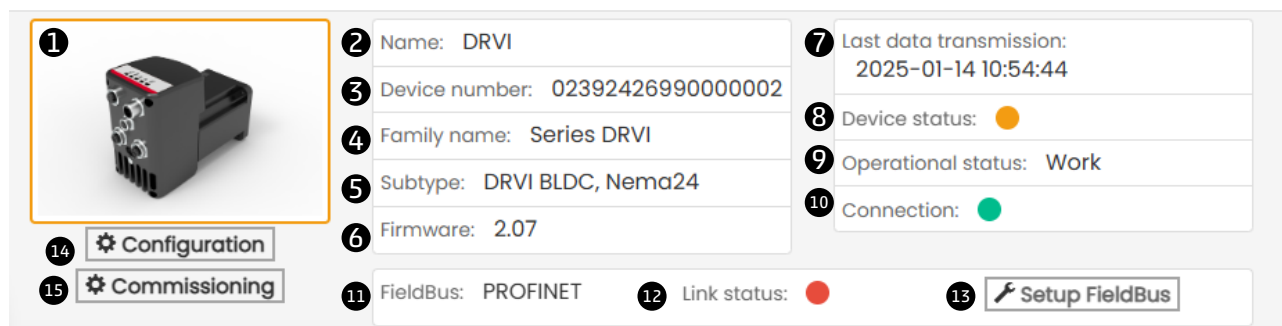





① 	② Name: DRVI	⑦ Last data transmission: 2025-01-14 10:54:44
	③ Device number: 02392426990000002	⑧ Device status: ●
	④ Family name: Series DRVI	⑨ Operational status: Work
	⑤ Subtype: DRVI BLDC, Nema24	⑩ Connection: ●
	⑥ Firmware: 2.07	
⑭ 	⑪ FieldBus: PROFINET	⑫ Link status: ●
⑮ 		⑬ 

Figure 7.2: Main page of the UVIX interface.

7.4 Details

The details section is divided into five tabs:

- Variables [7.4.1](#)
- Alarms [7.4.2](#)
- Commands [7.4.3](#)
- Error History [7.4.4](#)

7.4.1 Variables

The first tab of details shows the variables that are monitored by the DRVI device as shown in Figure [7.3](#).

The variables are listed below:

- Motor Size: *Nema 17, Nema 23, Nema 24*.
- Brake: *Present or Not present*.
- STO: *Present or Not present*.
- Actuator type:
 - *Only motor*
 - *Custom actuator*
- Servo state: *On or Off*.
- Mode of operation:
 - *Homing*
 - *Speed*
 - *Relative positioning*
 - *Absolute positioning*
 - *Torque*
- Actual pos: actual position measured in angular degrees or mm.
- Actual vel: actual velocity measured in RPM or mm / s.
- Total stroke: total stroke measured in m.
- Total time on: total time on measured in hours.
- Total time off: total time off measured in hours.
- Total time run: total time run measured in hours.
- Actuator screw pitch: measured in mm / round allows the conversion to linear measurement units, when an actuator is connected to the drive.
- Gear ratio: when a gear is placed between the drive and the actuator, this parameter is used to apply an automatic scale of the target.
- Product part number: drive descriptive code.
- Busy state: *True or False*.
- Total count power on: incremented every time device is turned on.
- Homing state: *Present or Not present*.
- Self Holding: *True or False*.
- Output GPIO: *On or Off*.

7.4 Details

Details: ▼

▣ Variables 🔔 Alarms 📏 Commands 🕒 Errors History 📊 Graphs	
Name	Value
Motor size	Nema 24
Brake	Not present
STO	Not present
Actuator type	Only motor
Servo state	Off
Mode of operation	None
Actual pos	315.45 °
Actual vel	-5.00 RPM
Total stroke	0 m
Total time on	0 hh
Total time off	0 hh
Total time run	0 hh
Actuator screw pitch	1.00
Gear ratio	100
Product part number	DRVI-24EC125-0E-PN
Busy state	False
Total count power on	9
Homing state	Not present
Self Holding	Off
Output GPIO	Off





Figure 7.3: Section for the variables monitored by the DRVI device.

7.4 Details

7.4.2 Alarms

The second tab of details displays possible DRVI alarms as shown in Figure 7.4.

All possible alarms are listed below:

- Error alarms: *Alarm active* , *Alarm not active*  .
 - VBUS under voltage.
 - VBUS over voltage.
 - VLOG under voltage.
 - VLOG over voltage.
 - Motor temperature.
 - Drive temperature,
 - Over current.
 - Fault in control loop.
 - Encoder fault.
 - Non-volatile memory fault.
 - Energy dissipation fault.
 - STO fault.
 - Homing fault.
- Warning alarms: *Alarm active* , *Alarm not active*  .
 - VBUS under voltage.
 - VBUS over voltage.
 - VLOG under voltage.
 - VLOG over voltage
 - Motor temperature.
 - Drive temperature.
 - Homing not done.
 - Target speed not reached.
 - Target position not reached.
 - Invalid command.
 - Position limit reached.

Details: ▼

▮ Variables 🔔 Alarms 📏 Commands 🕒 Errors History 📊 Graphs		
Event Name	Status ▼	Event Onset
Homing not done	⚠️	2025-01-14 10:46:59
VBUS under voltage	ⓘ	
VBUS over voltage	ⓘ	
VLOG under voltage	ⓘ	
VLOG over voltage	ⓘ	
Motor temperature	ⓘ	
Drive temperature	ⓘ	
Over current	ⓘ	
Fault in control loop	ⓘ	
Encoder fault	ⓘ	
Non-volatile memory fault	ⓘ	
I2t limit exceeded	ⓘ	
STO fault	ⓘ	
Homing	ⓘ	
Position limit reached	ⓘ	
Supply voltage DCDC/V15	ⓘ	
Brake Fault	ⓘ	
VBUS under voltage	⚠️	
VBUS over voltage	⚠️	
VLOG under voltage	⚠️	
VLOG over voltage	⚠️	
Motor temperature	⚠️	

Figure 7.4: Section for the alarms monitored by the DRVI device.

7.4 Details

7.4.3 Commands

The third tab of details shows the commands that can be sent via UVIX to the device. The manual mode command ① allows you to control the system manually from UVIX, sending configuration parameters to the DRVI. In manual mode, it is possible to reset the alarms ②, to set the digital output ③, to start or stop the motor movement ④, and to switch on/off the servo ⑤. The history of the commands sent to the DRVI since the communication with UVIX was started can be viewed under *Last Commands* ⑥.

Details: ▼

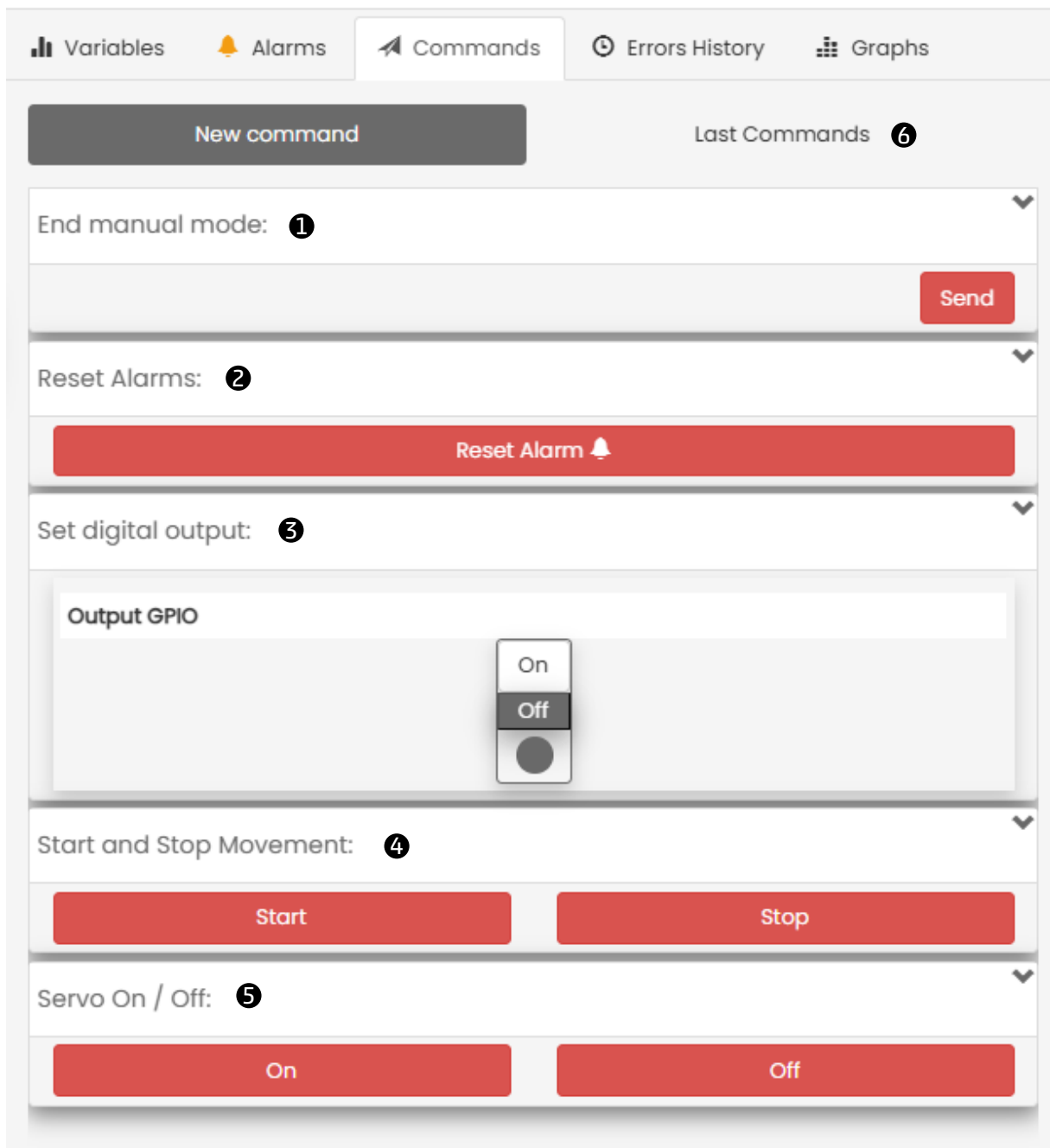

The screenshot displays the 'Commands' tab in the UVIX interface. At the top, there are navigation tabs: Variables, Alarms, Commands (selected), Errors History, and Graphs. Below the tabs, there is a 'New command' button and a 'Last Commands' link with a circled 6. The main area contains six command categories, each with a dropdown arrow on the right:

- End manual mode: ①**: Includes a red 'Send' button.
- Reset Alarms: ②**: Includes a red 'Reset Alarm' button with a bell icon.
- Set digital output: ③**: Includes an 'Output GPIO' section with 'On', 'Off', and a radio button.
- Start and Stop Movement: ④**: Includes 'Start' and 'Stop' buttons.
- Servo On / Off: ⑤**: Includes 'On' and 'Off' buttons.

Figure 7.5: Section for the commands managed by the DRVI device.

7.4 Details

7.4.4 Errors History

The fourth tab of details shows a table, which contains the last seven alarms that occurred, as shown in Figure 7.6. The table is made up of three columns:

- ❶ *Event Name*: alarm occurred
- ❷ *Count Power On*: incremented every time device is turned on
- ❸ *Error Time*: milliseconds elapsed since the last power on

The table is filled from top to bottom, so the most recent errors are in the top rows.

Details: ▼

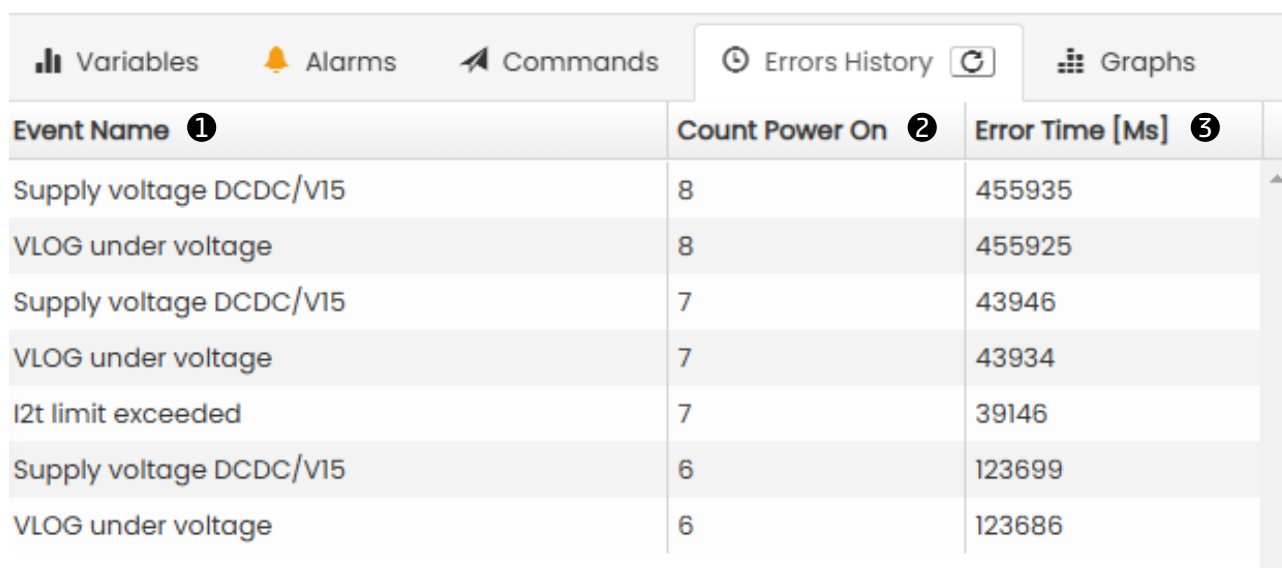

Event Name ❶	Count Power On ❷	Error Time [Ms] ❸
Supply voltage DCDC/V15	8	455935
VLOG under voltage	8	455925
Supply voltage DCDC/V15	7	43946
VLOG under voltage	7	43934
I2t limit exceeded	7	39146
Supply voltage DCDC/V15	6	123699
VLOG under voltage	6	123686

Figure 7.6: Error history section.

7.4.5 Graphs

The fifth tab of details on the DRVI device contains graphs that show the trend of variables 7.4.1 over time, as shown in Figure 7.7. It is possible to choose the variables to acquire ❶, start acquisition ❷, stop acquisition ❸, clear graph ❹ and save data in .csv format ❺.

Below the graph there is a thumbnail ❻ that allows to select an observation interval over time. There is also a flag ❼, which gives the possibility to select the same observation interval for all variables under acquisition. Otherwise, if the flag is not set, the observation interval can be chosen independently for each variable, as shown in Figure 7.8.

The graphs are printed starting from the values saved in a circular buffer. When the buffer fills up it is rewritten from the beginning, overwriting the old data. To avoid losing data it is possible to set a flag ❽, which enables automatic saving of data in .csv format every time the circular buffer is filled. The time it takes for the buffer to fill corresponds to *Graph UVIX window* and can be set in the *Communication* section 7.5.3 of configuration page 7.5. Depending on the choice of *Graph UVIX window*, a different sampling period for the variables is set.

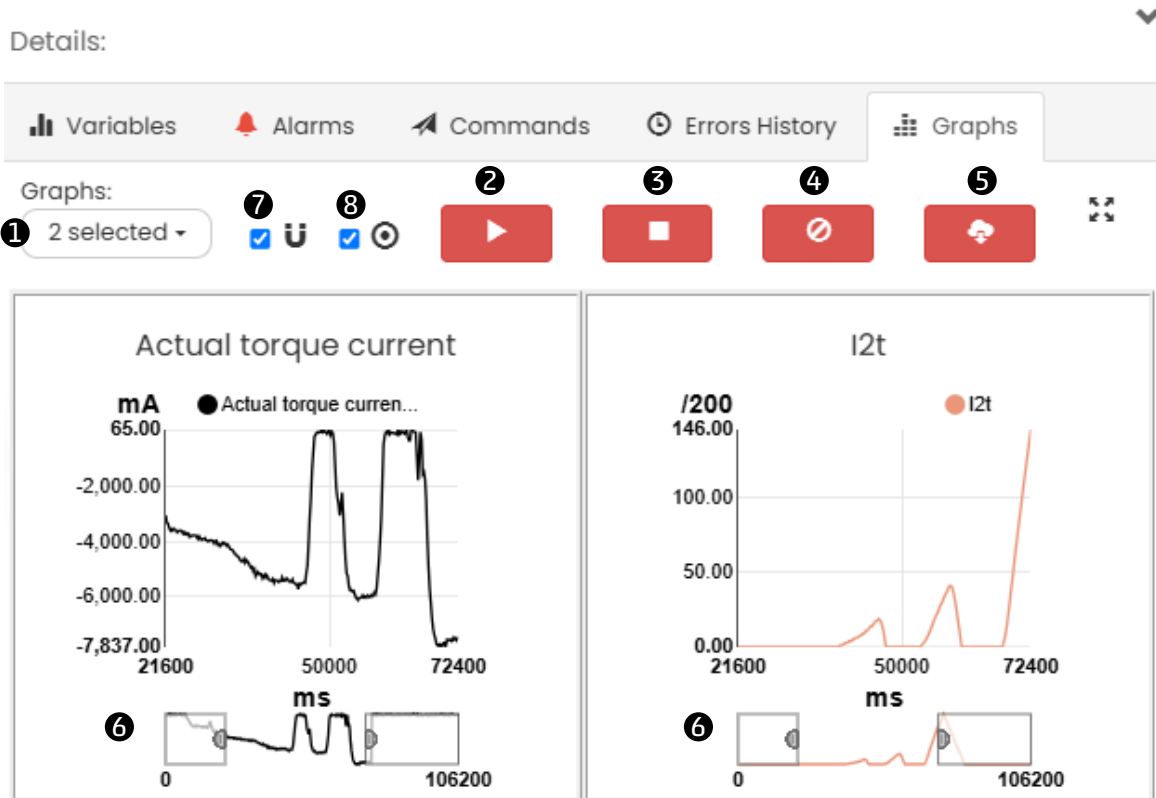

Figure 7.7: Section for graphing variables over time. In this example flag 7 is set, so *Actual torque current* and *I2t* are graphed over the same observation interval.

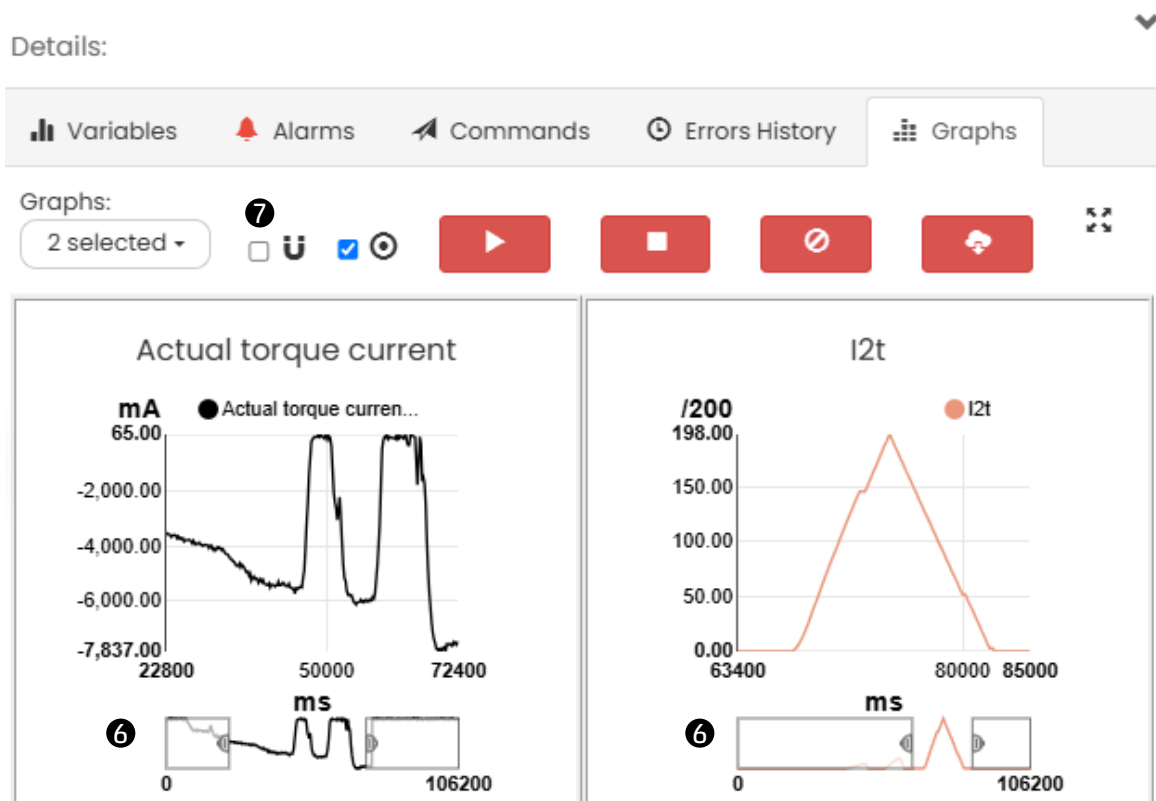

Figure 7.8: Section for graphing variables over time. In this example flag 7 is not set, so *Actual torque current* and *I2t* are graphed over different observation intervals.

7.5 Configuration

7.5 Configuration

From the status information page 7.3, it is possible to access to configuration page, where it is possible to configure certain operating-related parameters of the DRVI: actuator, motion and communication. All these parameters can be stored into the non volatile memory of the drive by clicking the buttons *Send* and subsequently *Save on device*.

7.5.1 Actuator

In the actuator section it is possible to set the following parameters:

- ❶ *Actuator type* can be:
 - *Only motor*
 - *Custom Actuator*
- ❷ *Gear ratio* is used to apply an automatic scale of the target (i.e.: profile parameters are multiplied by the gear ratio value).

The following items are software limits, that can be used to restrict the profile parameters:

- ❸ *Actuator screw pitch* measured in mm / round. This parameter allows the conversion to linear measurement units, when an actuator is connected to the drive.
- ❹ *Actuator limits* when enabled allow to modify the limit values.
- ❺ *Actuator minimum stroke* measured in mm (such value must be lesser than ❻).
- ❻ *Actuator maximum stroke* measured in mm (such value must be greater than ❺).
- ❼ *Actuator max speed* measured in mm / s.
- ❽ *Actuator max acceleration* measured in mm / s².
- ❾ *Actuator max deceleration* measured in mm / s².

ACTUATOR ▼

<p>Actuator type 2025-01-14 16:00:51</p> <p><input type="radio"/> Only motor</p> <p><input checked="" type="radio"/> Custom Actuator ❶</p>	<p>Actuator minimum stroke [mm]: 2025-01-14 16:00:51</p> <p>-21474836 ❺</p>
<p>❷ Gear ratio 2025-01-14 16:00:51</p> <p>1.00 ❷</p>	<p>Actuator maximum stroke [mm]: 2025-01-14 16:00:51</p> <p>21474836 ❻</p>
<p>Actuator screw pitch [min:0 , max:2000] mm/round: 2025-01-14 16:00:51</p> <p>1.00 ❸</p>	<p>Actuator max speed [mm/s]: 2025-01-14 16:00:51</p> <p>20000 ❼</p>
<p>❹ Actuator limits 2025-01-14 16:00:51</p> <p>Off <input type="checkbox"/> On ❹</p>	<p>Actuator max acceleration [mm/s²]: 2025-01-14 16:00:51</p> <p>65535 ❽</p>
	<p>Actuator max deceleration [mm/s²]: 2025-01-14 16:00:51</p> <p>65535 ❾</p>

Figure 7.9: Section for actuator configuration.

7.5 Configuration

7.5.2 Motion

In the motion section it is possible to set the follows parameters:

- 10 **Profile check**: No or Yes. Enable or disable the check of the actual rotor position, with respect to the target imposed.
- 11 **Profile check timeout** measured in ms. If "Profile check" is enabled, this parameters represents the time after which an advice is returned, if the actual rotor physical position does not match the target one. The time is started when the calculated motion profile (the theoretical value) has reached the target, so the delay is increased until the actual rotor position has not reached the target position; normally this condition could be due to the physical conditions (PID regulations, grip,...). If the timeout has expired, there are 2 possible situations: the distance between the physical vs the target position is over the warning threshold (typically 1 degree) so a warning message is generated, or the distance is over the error threshold (typically 6 degrees) so an error message is generated (error "software limits exceeded" with subcode 20).
- 12 **Direction of movements**: standard or inverse (with respect to convention, see Paragraph 6.1).
- 13 **Quick stop deceleration** measured in mm / s².
- 14 **Digital Input Mode**: No or Yes. Enable or disable the Digital Input Mode (4.2).
- 15 **Target torque limit for Digital Input Mode** measured in mA . Available only if Digital Input mode is enabled.

MOTION ▼

PROFILE

<div style="border: 1px solid #ccc; padding: 5px; margin-bottom: 5px;"> 2025-01-14 16:00:51 <p>? Check 10</p> <p>No <input checked="" type="checkbox"/> Yes</p> </div>	<div style="border: 1px solid #ccc; padding: 5px; margin-bottom: 5px;"> 2025-01-14 16:00:51 <p>? Check timeout [ms]: 11</p> <p>30</p> </div>
<div style="border: 1px solid #ccc; padding: 5px; margin-bottom: 5px;"> 2025-01-14 16:00:51 <p>? Direction of movements 12</p> <p><input checked="" type="radio"/> standard</p> <p><input type="radio"/> inverse</p> </div>	<div style="border: 1px solid #ccc; padding: 5px; margin-bottom: 5px;"> 2025-01-14 16:00:51 <p>? Quick Stop Deceleration [mm/s²]: 13</p> <p>4000</p> </div>
<div style="border: 1px solid #ccc; padding: 5px; margin-bottom: 5px;"> 2025-01-14 16:00:51 <p>? Digital Input Mode 14</p> <p>Off <input checked="" type="checkbox"/> On</p> </div>	<div style="border: 1px solid #ccc; padding: 5px; margin-bottom: 5px;"> 2025-01-14 16:00:51 <p>Target torque limit [min:-15000 , max:15000] mA: 15</p> <p>4000</p> </div>

Figure 7.10: Section for motion configuration.

7.5 Configuration

7.5.3 Communication

In the communication section (represented in Figure 7.11) it is possible to set the data endianness used by the fieldbus: *little endian* or *big endian*. It is also possible to select the *Graph UVIX window*, which is the maximum temporal width of Graphs (see 7.4.5). The sampling period of variables 7.4.1 depends on the choice of *Graph UVIX window*. The corresponding sampling period of each window is shown next to it in parentheses.

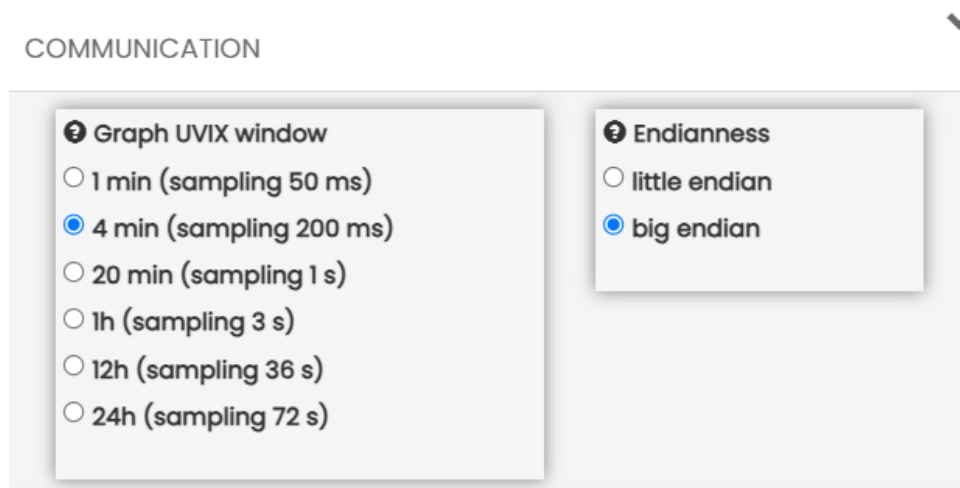

Figure 7.11: Section for communication configuration.

7.5.4 GPIO

In the GPIO section (represented in Figure 7.12) it is possible to set the polarity of the I/O.

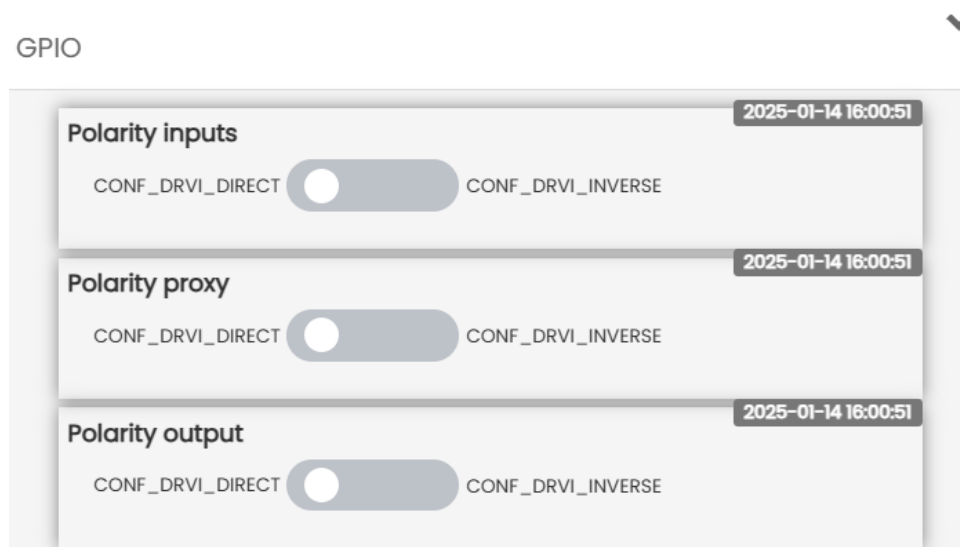

Figure 7.12: Section for I/O polarity.

7.6 Commissioning

7.6 Commissioning

From the status information page 7.3, it is possible to access to commissioning page, where it is possible to move the drive, as well as configure some of its parameters. Homing parameters and PID configuration can be stored into the non volatile memory of the drive by clicking the buttons *Send* and subsequently *Save on device*. Depending on enabling of Digital Input Mode there are two different commissioning pages: Standard 7.6.1 and Digital Input mode 7.6.2.

7.6.1 Standard commissioning page

Standard commissioning page (Figure 7.13) is visualized when Digital Input mode is disabled.

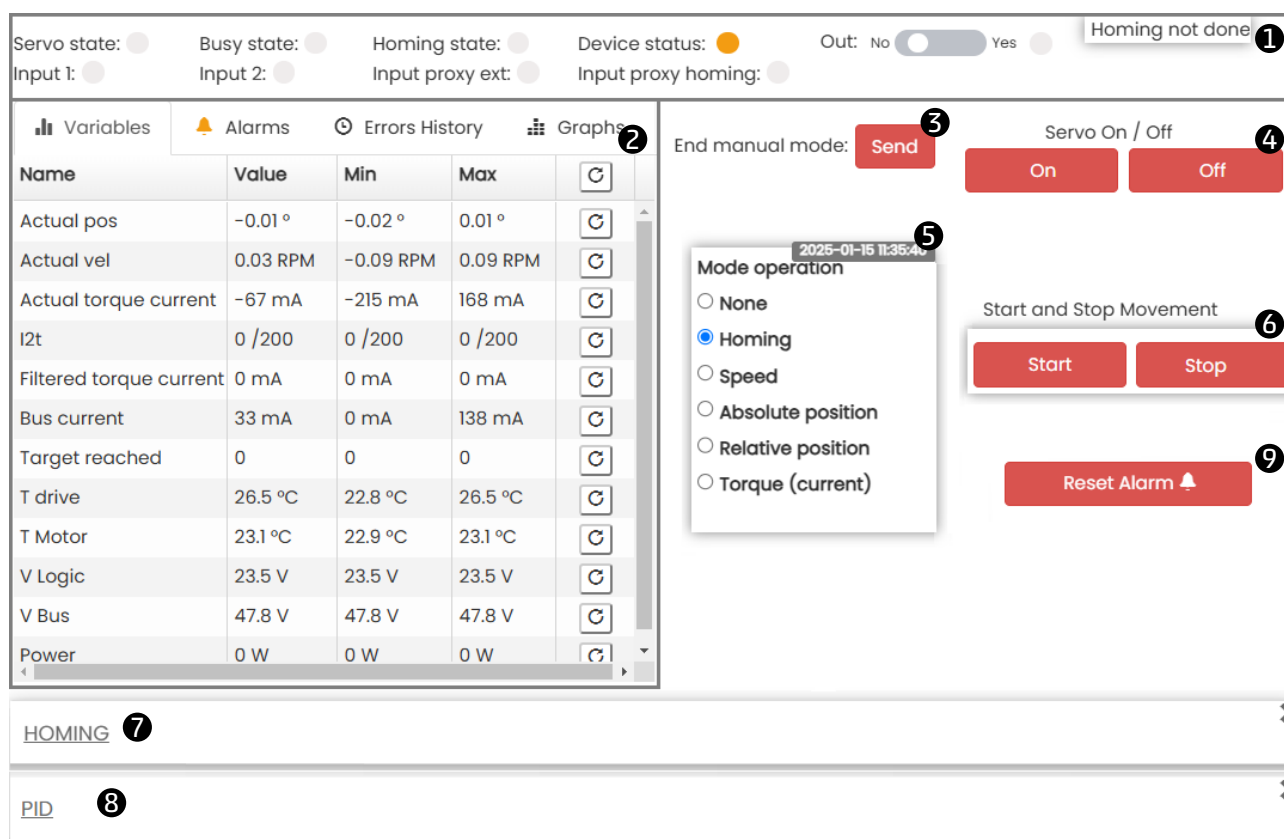

Name	Value	Min	Max	
Actual pos	-0.01 °	-0.02 °	0.01 °	🔄
Actual vel	0.03 RPM	-0.09 RPM	0.09 RPM	🔄
Actual torque current	-67 mA	-215 mA	168 mA	🔄
I2t	0 /200	0 /200	0 /200	🔄
Filtered torque current	0 mA	0 mA	0 mA	🔄
Bus current	33 mA	0 mA	138 mA	🔄
Target reached	0	0	0	🔄
T drive	26.5 °C	22.8 °C	26.5 °C	🔄
T Motor	23.1 °C	22.9 °C	23.1 °C	🔄
V Logic	23.5 V	23.5 V	23.5 V	🔄
V Bus	47.8 V	47.8 V	47.8 V	🔄
Power	0 W	0 W	0 W	🔄

Figure 7.13: Standard commissioning page.

The page is composed by:

- ① States of the DRVI: it is possible to watch the state of the DRVI, the state of the inputs, set the state of the output and if a fault is active
- ② Details tabs, the same ones presented in Chapter 7.4.
- ③ Command of the manual mode: *Start* or *End*.
- ④ Command of the servo: *On* or *Off*.
- ⑤ Mode operation selector (7.6.1.1).
- ⑥ Command of the movement (7.6.1.2) depending on operation mode selected.
- ⑦ Mode operation section (7.6.1.3), depending on operation mode selected.
- ⑧ PID configuration section, see Chapter 7.6.3.
- ⑨ Reset errors and warnings: *Reset Alarm*.

7.6 Commissioning

7.6.1.1 Mode operation selector

Mode operation selector **5** is used to select one of the following operation modes:

- *None*
- *Homing*
- *Speed*
- *Absolute position*
- *Relative position*
- *Torque*

⚠ When switching operation mode the Standard commissioning page changes slightly.

7.6.1.2 Command of the movement

Command of the movement **6** depends on operation mode selected. In case mode operation is set to *None* or *Homing* the only commands available are *Start* and *Stop* movement, as shown in Figure 7.13. Otherwise the Command of the movement changes, as shown in Figure 7.14.

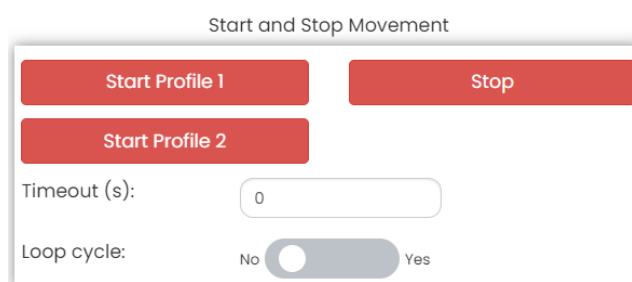

Figure 7.14: Section of the Start and Stop for not Homing modes.

- *Start Profile1*: this is the first target value.
- *Start Profile2*: this is the (optional) second target value.
- *Stop*: it ends the current movement.
- *Timeout*: it set the delay in seconds between profile1 and profile2 target. Be careful: set a value that is greater than the time elapsed to execute the movement.
- Loop cycle *No, Yes*: it enables the loop of movements between profile1 and profile2 target.

7.6.1.3 Mode operation section

Mode operation section **7** is generated when a mode operation other than *None* is selected. Each mode operation has its own section (except for *None*), so there are five Mode operation sections:

- *Homing section 7.6.1.4*
- *Speed section 7.6.1.5*
- *Absolute position section 7.6.1.6*
- *Relative position section 7.6.1.7*
- *Torque section 7.6.1.8*

7.6 Commissioning

7.6.1.4 Homing section

In the homing section (represented in Figure 7.15) it is possible to configuring homing parameters and select a type of homing:

- *Without proximity*
- *Proximity left*
- *Proximity right*
- *Proximity left + zero encoder*
- *Proximity right + zero encoder*
- *Torque left*
- *Torque right*
- *Torque left + zero encoder*
- *Torque right + zero encoder*

HOMING ▼

Homing type

Without proximity

Proximity positive direction

Proximity negative direction

Proximity positive direction + zero encoder

Proximity negative direction + zero encoder

Torque positive direction

Torque negative direction

Torque positive direction + zero encoder

Torque negative direction + zero encoder

A

Homing speed out [RPM]:

6.00 **E**

Homing acc out [RPM/s]:

3000 **F**

Homing dec out [RPM/s]:

3000 **G**

Homing Offset [°]:

0.00 **H**

Torque homing threshold [min:0 , max:100] %:

30 **I**

Torque limit

Off On **L**

Target torque limit [min:-15000 , max:15000] mA:

300 **M**

Homing speed search [RPM]:

12.00 **B**

Homing acc search [min:0 , max:65535] RPM/s:

3000 **C**

Homing dec search [RPM/s]:

3000 **D**

Figure 7.15: Section of the homing parameters.

7.6 Commissioning

The homing section is composed of:

- **A** Homing type selector
- **B** Homing speed search measured in RPM or mm / s.
- **C** Homing acceleration search measured in RPM / s or mm / s².
- **D** Homing deceleration search measured in RPM / s or mm / s².
- **E** Homing speed out measured in RPM or mm / s.
- **F** Homing acceleration out measured in RPM / s or mm / s².
- **G** Homing deceleration out measured in RPM / s or mm / s².
- **H** Homing offset measured in angular degrees or mm.
- **I** Torque homing threshold % with respect to the I²T value.
- **L** Torque limit enable *No, Yes*.
- **M** Target torque limit measured in mA.

Homing "search" parameters (e.g.: *Homing speed search*) are the ones used to find the proximity (or the end of the line), while "out" parameters (e.g.: *Homing speed out*) are the ones used to exit from the proximity (or the end of the line).

7.6 Commissioning

7.6.1.5 Speed Profile section

In the speed profile section (represented in Figure 7.16) it is possible to set the motion profile parameters for the speed control for two target speed, profile1 and (optional) profile2. Moreover it is possible to enable/disable the check of the Torque limit and its threshold value in mA.

SPEED PROFILE ▼

PROFILE 1	PROFILE 2
<p>Target speed [RPM]: A</p> <input type="text" value="1000.00"/>	<p>Target speed [RPM]:</p> <input type="text" value="2000.00"/>
<p>Target acceleration [RPM/s]: B</p> <input type="text" value="100"/>	<p>Target acceleration [RPM/s]:</p> <input type="text" value="100"/>
<p>Target deceleration [RPM/s]: C</p> <input type="text" value="100"/>	<p>Target deceleration [RPM/s]:</p> <input type="text" value="100"/>
<p>Torque limit</p> <p>Off <input checked="" type="checkbox"/> On D</p>	<p>Target torque limit [min:-15000 , max:15000] mA:</p> <input type="text" value="300"/> E

Figure 7.16: Section of the speed profile parameters.

The speed profile section is composed of:

- **A** Target speed measured in RPM or mm / s.
- **B** Target acceleration measured in RPM / s or mm / s².
- **C** Target deceleration measured in RPM / s or mm / s².
- **D** Torque limit enable *No*, *Yes*.
- **E** Target torque limit measured in mA.

7.6 Commissioning

7.6.1.6 Absolute position section

In the absolute position section (represented in Figure 7.17) it is possible to set the motion profile parameters for the absolute position control for two target positions, profile1 and (optional) profile2. Moreover it is possible to enable/disable the check of the Torque limit and its threshold value in mA:

ABSOLUTE POSITION PROFILE

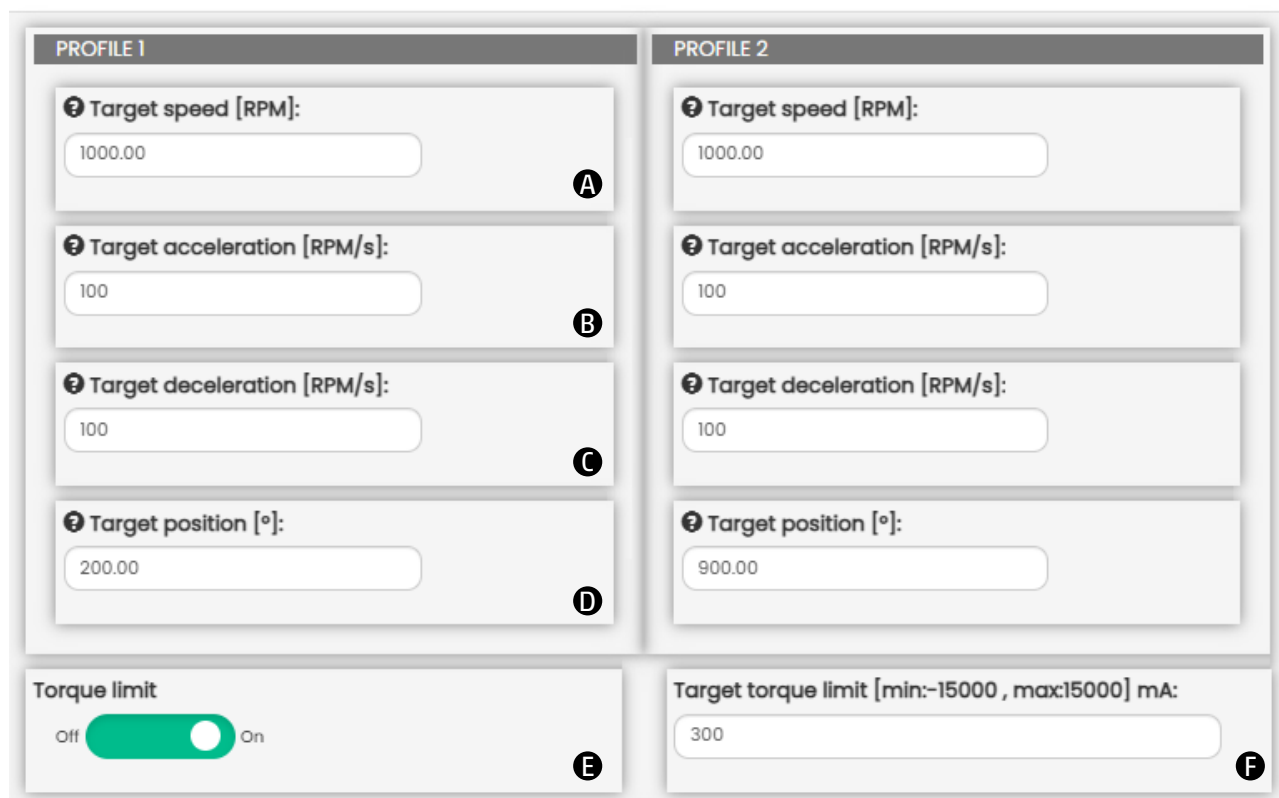

PROFILE 1	PROFILE 2
Target speed [RPM]: 1000.00 (A)	Target speed [RPM]: 1000.00
Target acceleration [RPM/s]: 100 (B)	Target acceleration [RPM/s]: 100
Target deceleration [RPM/s]: 100 (C)	Target deceleration [RPM/s]: 100
Target position [°]: 200.00 (D)	Target position [°]: 900.00
Torque limit Off <input checked="" type="checkbox"/> On (E)	Target torque limit [min:-15000, max:15000] mA: 300 (F)

Figure 7.17: Section of the absolute position profile parameters.

The absolute position section is composed of:

- **A** Target speed search measured in RPM or mm / s.
- **B** Target acceleration measured in RPM / s or mm / s².
- **C** Target deceleration measured in RPM / s or mm / s².
- **D** Target position measured in angular degrees or mm.
- **E** Torque limit enable *No*, *Yes*.
- **F** Target torque limit measured in mA.

7.6 Commissioning

7.6.1.7 Relative position section

In the relative position section (represented in Figure 7.18) it is possible to set the motion profile parameters for the relative position control for 2 target positions, profile1 and (optional) profile2. Moreover it is possible to enable/disable the check of the Torque limit and its threshold value in mA:

RELATIVE POSITION PROFILE ▼

PROFILE 1	PROFILE 2
<p>Target speed [RPM]: 1000.00 A</p>	<p>Target speed [RPM]: 1000.00</p>
<p>Target acceleration [RPM/s]: 100 B</p>	<p>Target acceleration [RPM/s]: 100</p>
<p>Target deceleration [RPM/s]: 100 C</p>	<p>Target deceleration [RPM/s]: 100</p>
<p>Target position [°]: 200.00 D</p>	<p>Target position [°]: 900.00</p>
<p>Torque limit Off <input checked="" type="checkbox"/> On E</p>	<p>Target torque limit [min:-15000 , max:15000] mA: 300 F</p>

Figure 7.18: Section of the relative position profile parameters.

The relative position section is composed of:

- **A** Target speed search measured in RPM or mm / s.
- **B** Target acceleration measured in RPM / s or mm / s².
- **C** Target deceleration measured in RPM / s or mm / s².
- **D** Target position measured in angular degrees or mm.
- **E** Torque limit enable *No*, *Yes*.
- **F** Target torque limit measured in mA.

7.6 Commissioning

7.6.1.8 Torque profile section

In the torque profile section (represented in Figure 7.19) it is possible to set the motion profile parameters for the torque (current) control for two target positions, profile1 and (optional) profile2:

TORQUE PROFILE ▼

PROFILE 1	PROFILE 2
Target torque (current) [min:-15000 , max:15000] mA: <input type="text" value="300"/> A	Target torque (current) [min:-15000 , max:15000] mA: <input type="text" value="5000"/>
? Torque Slope Acceleration [mA/s]: <input type="text" value="50"/> B	? Torque Slope Acceleration [mA/s]: <input type="text" value="1000"/>
? Torque Slope Deceleration [mA/s]: <input type="text" value="50"/> C	? Torque Slope Deceleration [mA/s]: <input type="text" value="1000"/>

Figure 7.19: Section of the torque profile parameters.

The torque profile section is composed of:

- **A** Target torque (current) measured in mA.
- **B** Target slope acceleration measured in mA / s.
- **C** Target slope deceleration measured in mA / s.

7.6 Commissioning

7.6.2 Digital Input mode commissioning page

Digital Input mode commissioning page (Figure 7.20) is visualized when Digital Input mode is enabled.

Name	Value	Min	Max
Actual pos	75.53 °	-231.39 °	176.30 °
Actual vel	0.02 RPM	-181.70 RPM	181.24 RPM
Actual torque curr...	161 mA	-258 mA	342 mA
I2t	0 /200	0 /200	0 /200
Filtered torque cur...	171 mA	-52 mA	173 mA
Bus current	14 mA	3 mA	125 mA
Target reached	1	0	1
T drive	39.0 °C	37.1 °C	39.0 °C
T Motor	39.4 °C	39.4 °C	40.8 °C
V Logic	23.1 V	23.1 V	23.2 V
V Bus	47.7 V	47.7 V	47.7 V
Power	0 W	0 W	0 W

Figure 7.20: Digital Input mode commissioning page.

Only some sections of the standard commissioning page (Figure 7.13) are visible:

- ① States of the DRVI: it is possible to watch the state of the DRVI, the state of the inputs, set the state of the output and if a fault is active
- ② Details tabs, see 7.4.
- ③ Command of the manual mode: *Start* or *End*.
- ⑤ Mode operation selector, useless because there is only one operating mode.
- ⑦ Mode operation section which corresponds to Jog section (7.6.2.1).
- ⑧ PID configuration section, see 7.6.3.
- ⑨ Reset errors and warnings: *Reset Alarm*.

There is an additional section dedicated to the Digital Input mode:

- ⑩ *Self holding* configuration. The LED turns green when the device configuration is consistent with the one selected by UVIX.

Command of the servo ④ is not visible, because in Digital Input mode device is always servo on. Command of the movement ⑥ is not visible because the movement is controlled by the inputs.

7.6 Commissioning

7.6.2.1 Jog section

In the jog section (represented in Figure 7.21) it is possible to set parameters for Digital Input mode:

JOG

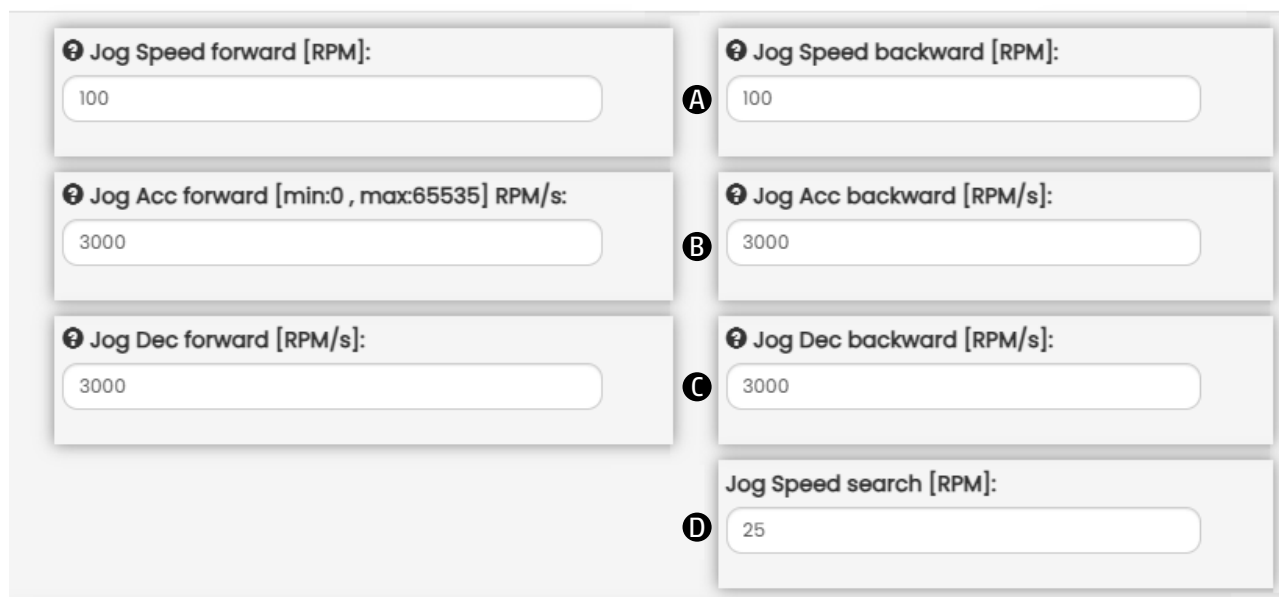

The screenshot shows a configuration interface for the JOG section. It consists of several input fields arranged in two columns. The left column contains three fields: 'Jog Speed forward [RPM]' with a value of 100, 'Jog Acc forward [min:0 , max:65535] RPM/s' with a value of 3000, and 'Jog Dec forward [RPM/s]' with a value of 3000. The right column contains three fields: 'Jog Speed backward [RPM]' with a value of 100, 'Jog Acc backward [RPM/s]' with a value of 3000, and 'Jog Dec backward [RPM/s]' with a value of 3000. Below these is a fourth field: 'Jog Speed search [RPM]' with a value of 25. Circled letters A, B, and C are placed between the columns, pointing to the speed, acceleration, and deceleration fields respectively. Letter D is placed to the left of the search speed field.

Figure 7.21: Digital Input mode parameters.

The jog section is composed of:

- **A** Jog target speed measured in RPM or mm / s.
- **B** Jog target acceleration measured in RPM / s or mm / s².
- **C** Jog target deceleration measured in RPM / s or mm / s².
- **D** Jog target speed search measured in RPM or mm / s. Used only in *Self holding with positioning* 4.2.3.

Note: in Digital Input mode it is possible to set torque limit, but this must be done in configuration, within the Motion section 7.5.2.

7.6 Commissioning

7.6.3 PID configuration section

The PID configuration section (represented in Figure 7.22) is always available, regardless of Digital Input mode enablement. This section allows to set the PID values used in the motion profiles (KP speed, KI speed and KP position) by choosing between five configurations:

- Default
- Low load
- Medium load
- High load
- Custom

Default configuration is used for moving motor not connected to cylinder or axis. Low, medium and high load configurations are used to move motor mounted on cylinders/axes with increasing stiffness or larger loads.

The PID values of these configurations depends on type of motor:

- DRVI-24EC125 (Brushless) see Table 7.1
- DRVI-23ST012 (Nema 23) see Table 7.2
- DRVI-24ST022 (Nema 24) see Table 7.3

Table 7.1: PID values for DRVI-24EC125 (brushless).

	Default	Low Load	Medium Load	High Load
KP speed	1000	1500	3000	5000
KI speed	1	1,5	3	5
KP position	0,1	0,15	0,3	0,5

Table 7.2: PID values for DRVI-23ST012 (Nema23).

	Default	Low Load	Medium Load	High Load
KP speed	100	1000	2000	3000
KI speed	1	1	2	3
KP position	0,1	0,1	0,2	0,3

Table 7.3: PID values for DRVI-24ST022 (Nema24).

	Default	Low Load	Medium Load	High Load
KP speed	500	600	1000	1500
KI speed	0,5	0,6	1	1,5
KP position	0,05	0,06	0,1	0,1

7.6 Commissioning

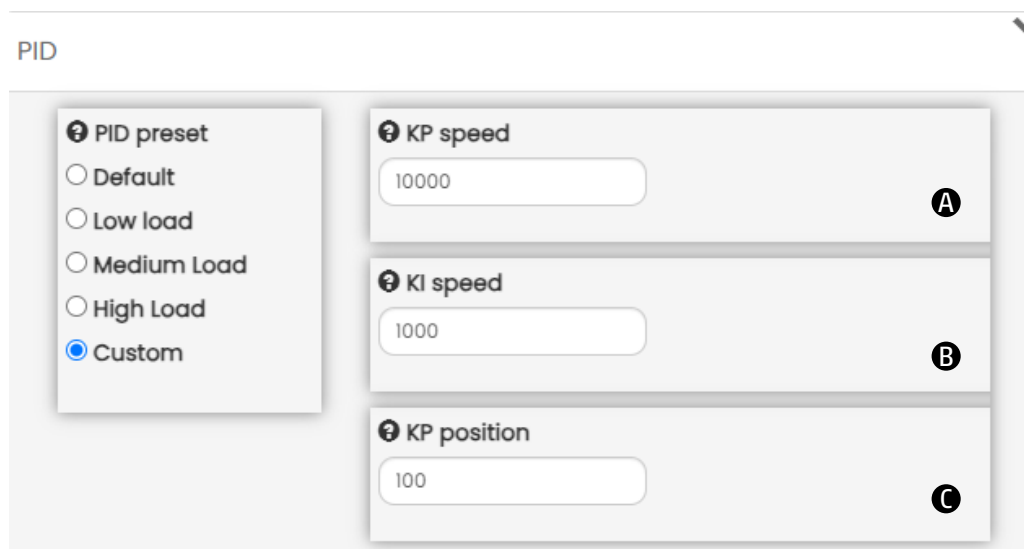

Figure 7.22: Section of the custom PID control.

The PID values can be fully customized only if Custom configuration is selected, only in this case three label appears:

- **A** KP speed
- **B** KI speed
- **C** KP position

⚠ Consider that the UVIX values of KP speed, KI speed and KP position are divided by the division factors, respectively 10, 1000 and 10. For example, by inserting into UVIX:

KP speed (UVIX) = 10000 ; KI speed (UVIX) = 1000 ; KP position (UVIX) = 1

they are actually set at:

KP speed = 1000,0 ; KI speed = 1,000 ; KP position = 0,1.

7.7 EthernetIP configuration

7.7 EthernetIP configuration

From the status information page, you can access the window for configuring certain fieldbus parameters. In the specific case of EthernetIP, you can configure the station name ❶, the IP address ❷, the mask ❸ and the gateway address ❹ of the device. Using the buttons in the bottom bar of the configuration window ❺, the configured parameters can be sent to the module, saved on the PC, saved on the device, or reset to default values.

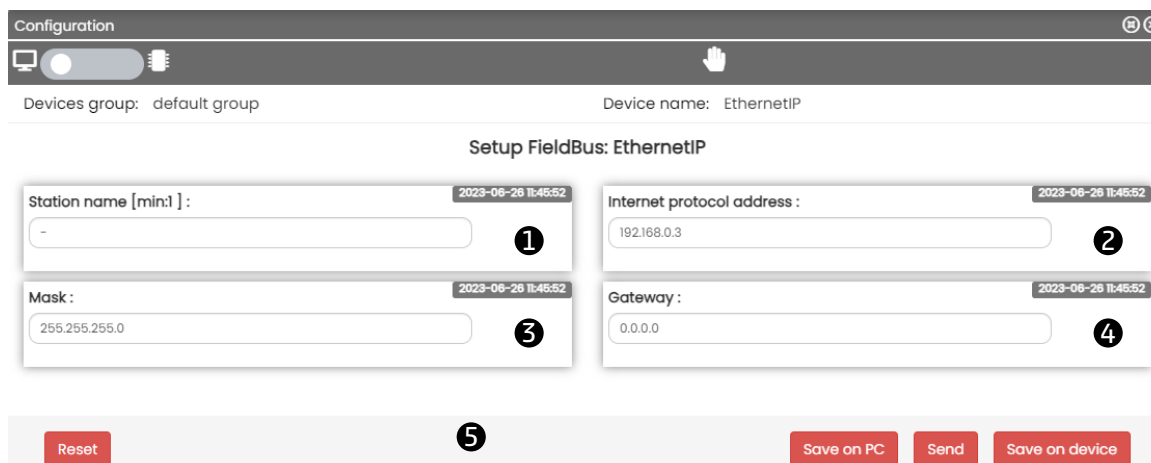

Figure 7.23: Section of the EthernetIP parameters configuration.

The fieldbus default values are shown in Table 7.4.

Table 7.4: Fieldbus default values.

Parameter	Value
Station name	-
IP address	192.168.0.3
Mask	255.255.255.0
Gateway	0.0.0.0

7.8 UVIX USB Gateway

7.8 UVIX USB Gateway

The DRVI can be connected to a PC via a USB cable. This connection - subject to prior installation of UVIX on the PC - allows you to communicate with the module through the Camozzi USB Gateway.

7.8.1 Main page

- ① Toolbar: for managing all the functionalities of the USB Gateway.
- ② USB Gateway Commands: to start or stop the USB Gateway and open the webApp.
- ③ Status: indicates the status of the USB Gateway.
- ④ Open COMs: List of devices currently communicating.
- ⑤ Virtual COM ports available and addresses of TCP connection for the connected COM ports.
- ⑥ Data received from the COM port
- ⑦ Data received on the FEP of the UVIX system.

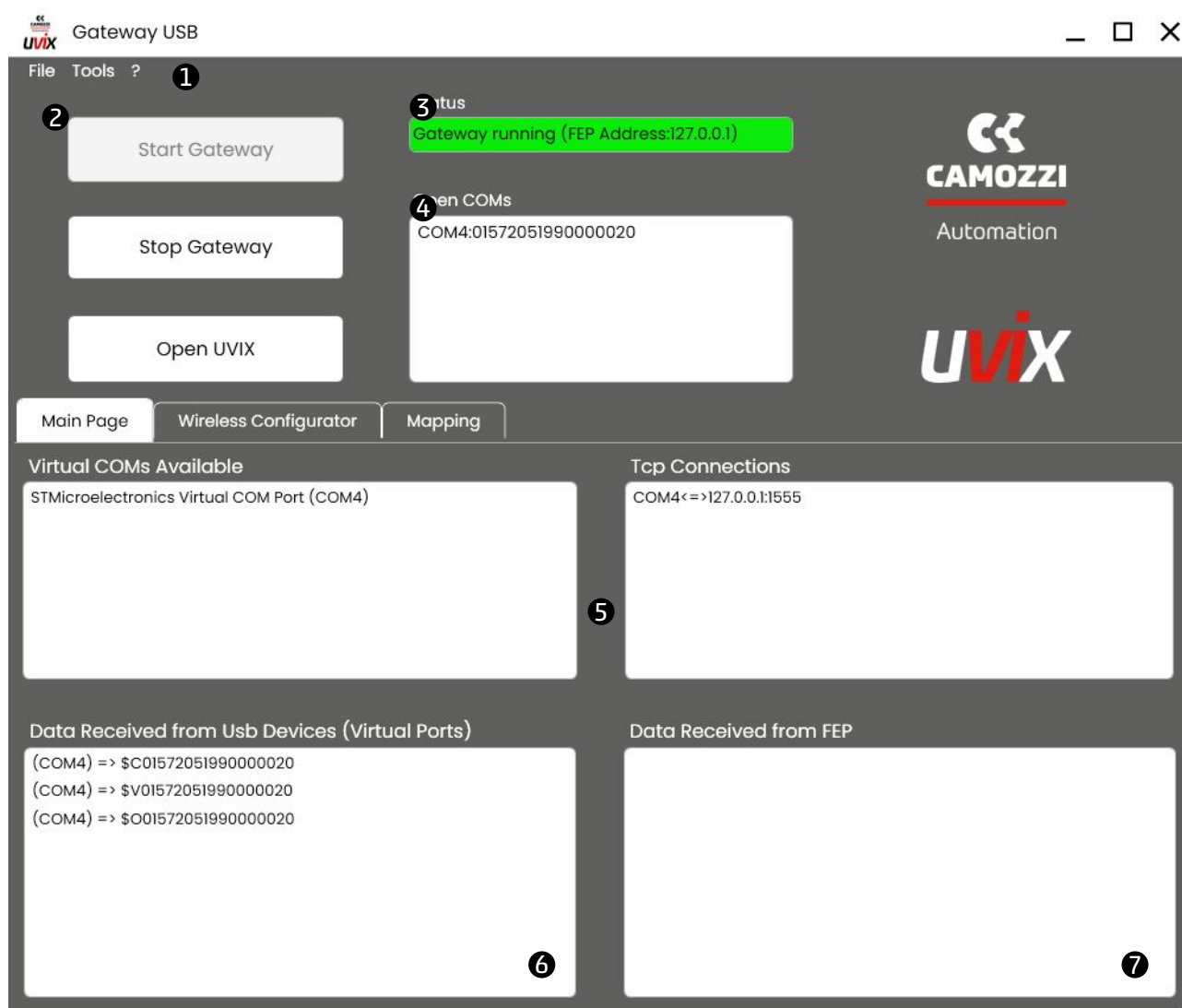

Figure 7.24: Gateway USB.

7.8 UVIX USB Gateway

7.8.2 Ethernet device configuration

The USB Gateway also allows to connect to the DRVI using Ethernet instead USB ⑧ (see Figure 7.25).

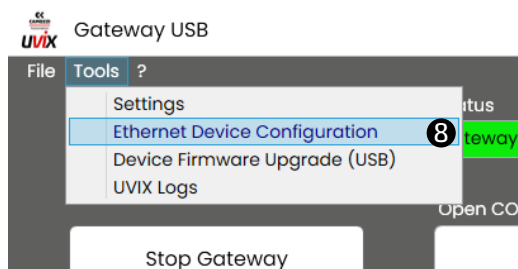

Figure 7.25: Ethernet device configuration section.

The *Ethernet device configuration* window will appear (see Figure 7.26). Choose the correct network adapter from the drop-down menu ①. After that the device connected will be visible ②, you need to select it and set the IP address ③.

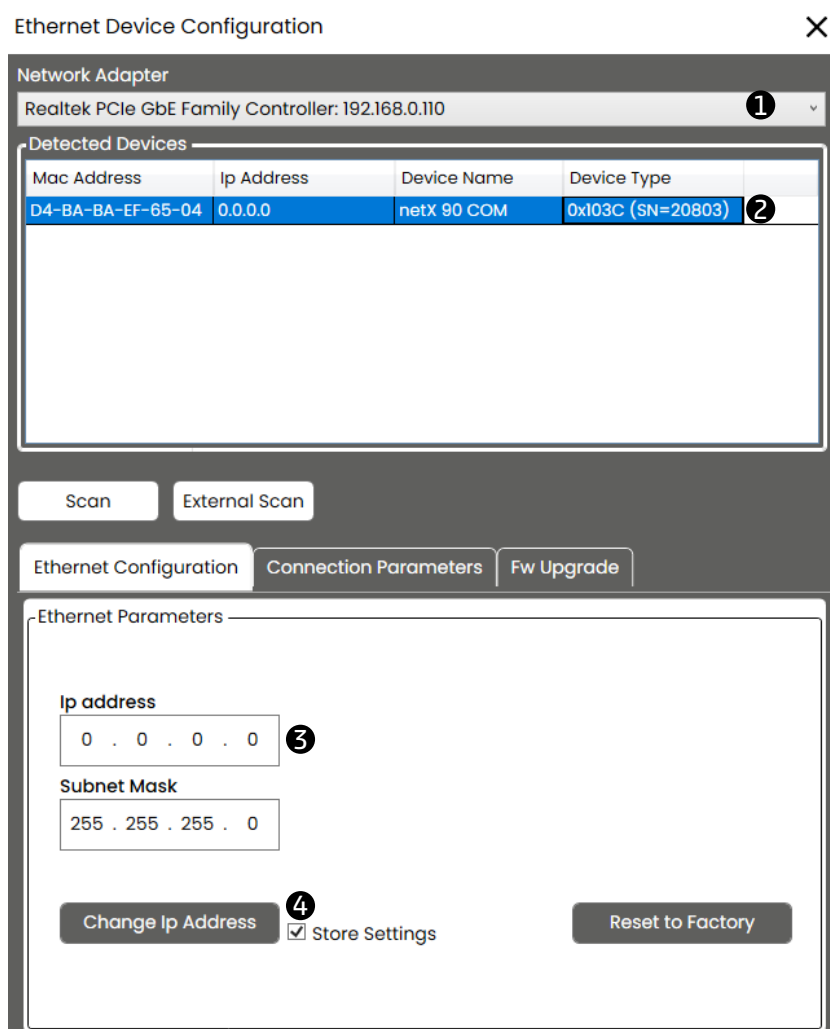

Figure 7.26: Ethernet device configuration window.

Then click on *Change Ip Address* button ④ and confirm your choice (see Figure 7.27). Subsequently another pop up will appear to notify the response from the new device and therefore the start of a new scan (see Figure 7.28).

7.8 UVIX USB Gateway

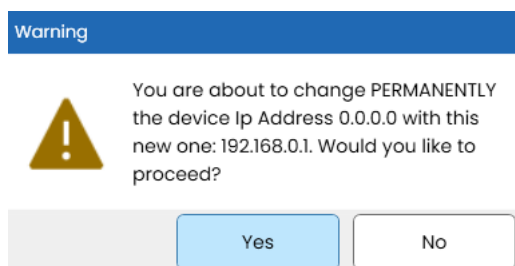

Figure 7.27: Pop-up that warns of permanent IP change.

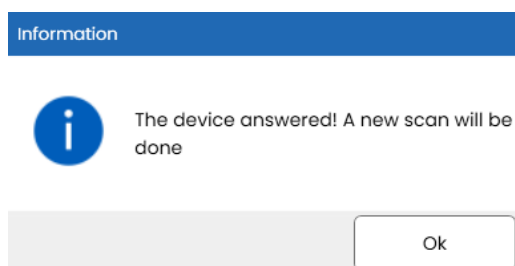

Figure 7.28: Pop-up that informs new device detected.

After setting the IP address, switch to *Connection Parameters* tab **5** and check if the new device is available (see Figure 7.29).

If you don't see the device you can start a new scan manually by clicking the *Scan* button **6**. Then select the device and click the *Start Communication* button **7**.

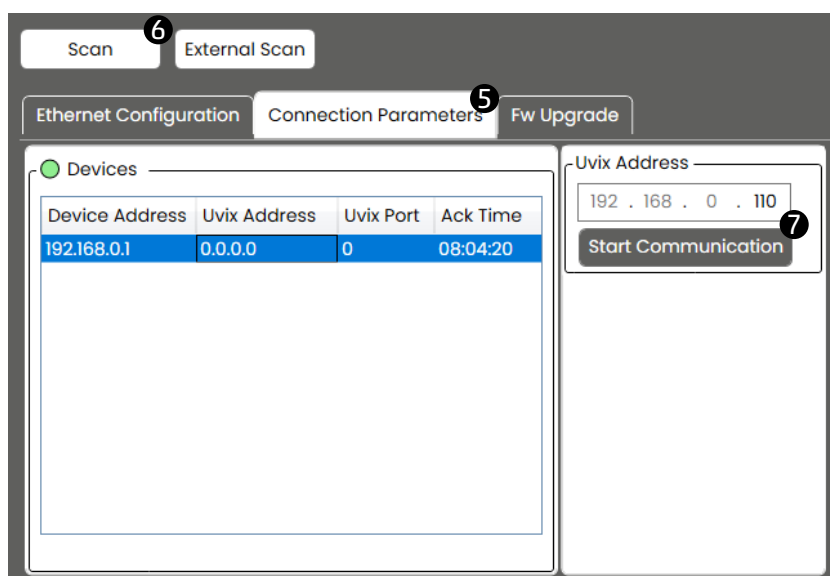

Figure 7.29: Connection Parameters tab, part of Ethernet device configuration window.

Another pop-up will appear (see Figure 7.30), confirm your choice.

If everything is ok you should be in the same condition of Figure 7.31.

Now you can close the *Ethernet device configuration* window and click on *Open uvix* button, visible in Figure 7.24. UVIX page will open and it will communicate with the device via Ethernet.

⚠ Variables 7.4.1 are not available via Ethernet, to see them you need to communicate via USB.

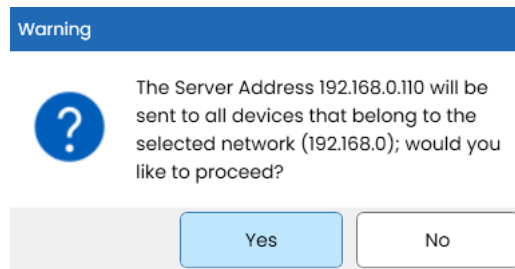

Figure 7.30: Pop-up to confirm sending to all devices of the server address.

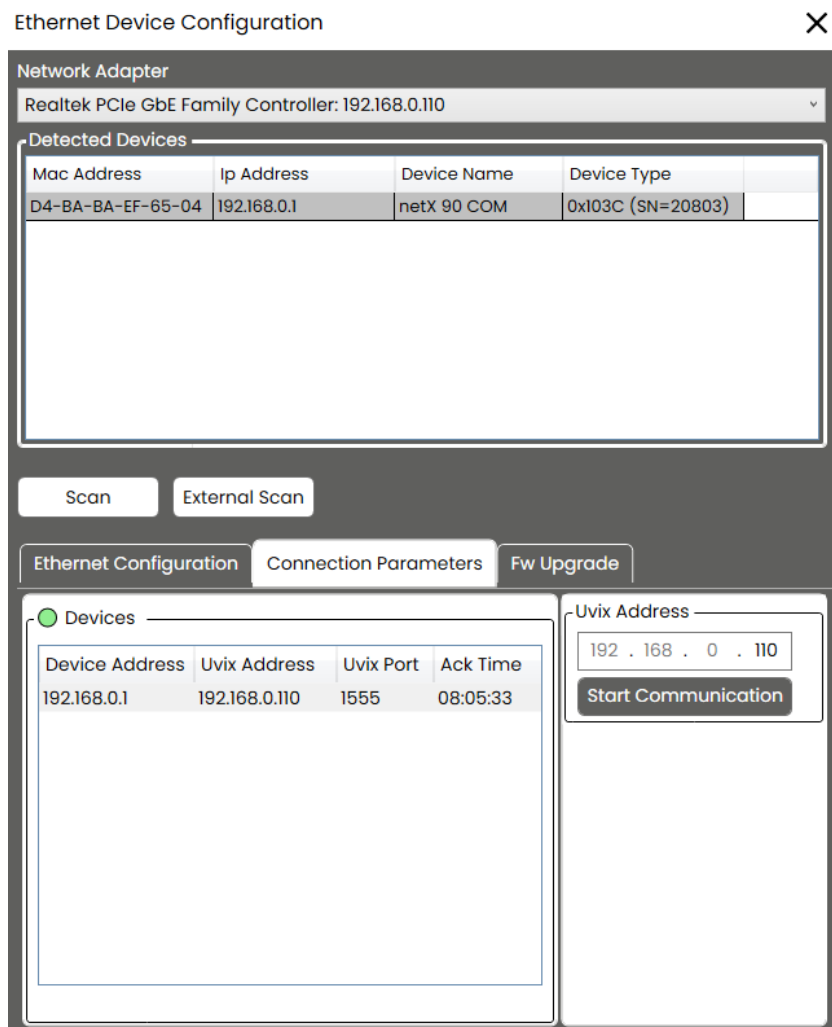

Figure 7.31: Ethernet device configuration window after a successful configuration.



Il sottoscritto, rappresentante il seguente costruttore

Camozzi Automation S.p.A.

Sede Legale:
Via R. Rubattino, 81
20134 Milano (Italy)

Sede Operativa:
Via Eritrea, 20/I
25126 Brescia - Italy

Tel: +39 030 37921
Fax: +39 030 2400464
E-mail: info@camozzi.com
<http://www.camozzi.com>

Sotto la propria ed esclusiva responsabilità **DICHIARA** che :

Azionamento integrato con controllo vettoriale Serie DRVI

Nelle versioni elencate a pagina 4

Anno fabbricazione: 2024-2028

L'oggetto della dichiarazione di cui sopra è conforme alla pertinente normativa di
armonizzazione dell'Unione:

2006/42/CE	DIRETTIVA 2006/42/CE DEL PARLAMENTO EUROPEO E DEL CONSIGLIO del 17 maggio 2006 relativa alle macchine e che modifica la direttiva 95/16/CE
2014/30/EU	DIRETTIVA 2014/30/UE DEL PARLAMENTO EUROPEO E DEL CONSIGLIO del 26 febbraio 2014 concernente l'armonizzazione delle legislazioni degli Stati membri relative alla compatibilità elettromagnetica

e che sono state applicate tutte le norme e/o specifiche tecniche indicate a pagina 2.

La presente dichiarazione di conformità è rilasciata sotto la responsabilità esclusiva del
fabbricante

Brescia, Italia

Camozzi Automation S.p.A.
Product Certification Manager
Guerrini Fabrizio

Alle seguenti principali norme armonizzate:

NORMA	TITOLO
EN ISO 12100:2010	Sicurezza del macchinario - Principi generali di progettazione - Valutazione del rischio e riduzione del rischio
ISO/TR 14121-2:2013	Sicurezza del macchinario - Valutazione del rischio - Parte 2: Guida pratica ed esempi di metodi
EN 61800-5-2:2007	Azionamenti elettrici a velocità variabile Parte 5-2: Prescrizioni di sicurezza - Sicurezza funzionale
EN 60204-1:2018	Sicurezza del macchinario - Equipaggiamento elettrico delle macchine - Parte 1: Regole generali
EN ISO 13849-1:2015	Sicurezza del macchinario - Parti dei sistemi di comando legate alla sicurezza - Parte 1: Principi generali per la progettazione
EN ISO 13849-2:2012	Sicurezza del macchinario - Parti dei sistemi di comando legate alla sicurezza - Parte 2: Validazione
EN 61000-6-4:2007/A1:2011	Compatibilità elettromagnetica (EMC) - Parte 6-4: Norme generiche - Emissione per ambienti industriali
EN 61000-6-2:2005/AC:2005	Compatibilità elettromagnetica (EMC) - Parte 6-2: Norme generiche - Immunità per ambienti industriali
EN ISO 13857:2019	Sicurezza del macchinario - Distanze di sicurezza per impedire il raggiungimento di zone pericolose con gli arti superiori e inferiori
EN ISO 14120:2015	Sicurezza del macchinario - Ripari - Requisiti generali per la progettazione e la costruzione di ripari fissi e mobili

Alle seguenti principali norme:

NORMA	TITOLO
EN 61800-5-1:2007	Azionamenti elettrici a velocità variabile Parte 5-1: Prescrizioni di sicurezza - Sicurezza elettrica, termica ed energetica
EN 61800-5-2:2017	Azionamenti elettrici a velocità variabile Parte 5-2: Prescrizioni di sicurezza - Sicurezza funzionale (Applicato capitolo 9 "Test requirements")
EN 61508 DA 1 A 7:2011	Sicurezza funzionale dei sistemi elettrici, elettronici ed elettronici programmabili per applicazioni di sicurezza

procedura di valutazione di conformità utilizzata

Allegato IX più Allegato VII (controllo interno della fabbricazione)

organismo notificato incaricato della valutazione

Bureau Veritas Italia
n. 1370

Viale Monza, 347
20126 Milano (MI)

numero identificativo del certificato di esame CE di tipo

CE-1370-xxxxxxx

La documentazione tecnica pertinente è stata redatta conformemente all' Allegato VII A della Direttiva 2006/42/CE.

Il certificato è conservato presso il nostro ufficio tecnico e copia conforme verrà inviata su richiesta.

Persona AUTORIZZATA a costituire il fascicolo tecnico

Nome Fabrizio
Cognome Guerrini
Società Camozzi Automation S.p.A.
Indirizzo Sede Legale
Via R. Rubattino, 81
20134 Milano (MI)

Sede Operativa
Via Cav. Attilio Camozzi, 13/15
25080 Polpenazze d/G (BS)

ESEMPIO DI CODIFICA

DRVI	-	23	ST	012	-	0	E	-	PN	SF	S	01
-------------	---	-----------	-----------	------------	---	----------	----------	---	-----------	-----------	----------	-----------

DRVI	SERIE
23	FLANGIA MOTORE 23 = Nema 23 24 = Nema 24
ST	TIPO MOTORE ST = stepper EC = brushless DC
012	COPPIA 012 = 1,2 Nm (Nema 23) 022 = 2,2 Nm (Nema 24) 125 = 125 W (solo per EC)
0	FRENO MOTORE 0 = senza freno B = con freno
E	RETROAZIONE DEL MOTORE E = Encoder assoluto, singolo giro
PN	PROTOCOLLO PN = Profinet CO = CANopen EC = EtherCAT EI = EtherNet/IP
SF	FUNZIONI AGGIUNTIVE SF = Safe torque off
S	VERSIONE = versione standard S = versione Custom
01	Numero progressivo versione (solo per versioni custom)* *Nota: le versioni custom coperte dal presente certificato riguardano varianti meccaniche non impattanti la funzione di sicurezza, quali: connessioni , flange, riduttori, giunti, lunghezza dell'albero di trasmissione, scanalature e forma dello stesso albero di trasmissione, colore del prodotto



Automation

A Camozzi Group Company

camozzi.com

Contacts

Camozzi Automation S.p.A.

Società Unipersonale

REGISTERED OFFICE

Via R. Rubattino, 81

20134 Milano

Italy

OPERATIONAL HEADQUARTERS

Via Eritrea, 20/1

25126 Brescia

Italy

Tel. +39 030 37921

marketing@camozzi.com

Customer Service

Tel. +39 030 3792790

service@camozzi.com

Export Department

Tel. +39 030 3792253

sales@camozzi.com