

# Safety Door Lock Switch



## SFDL Series

### PRODUCT MANUAL

For your safety, read and follow the considerations written in the instruction manual, other manuals and Autonics website.

The specifications, dimensions, etc. are subject to change without notice for product improvement. Some models may be discontinued without notice.

#### Main Features

- Available to change the direction of inserting the operation key by rotating head  
: Inserting the operation key from 5 directions in the top and side
- Various kinds of contact composition  
: 4-contact (connected), 4-contact (not connected), 5-contact, 6-contact
- Selectable between connector type which reduces working process and separable terminal type which is useful for maintenance
- Manual unlock function to handle the emergency  
: Cross type/special type release key line-up
- Minimized solenoid heat with stable current supply
- Excellent solidity/durability of metallic head
- Applicable to various applications using the slide key unit accessory

#### Safety Considerations

- Observe all 'Safety Considerations' for safe and proper operation to avoid hazards.
- ⚠ symbol indicates caution due to special circumstances in which hazards may occur.

**⚠ Warning** Failure to follow instructions may result in serious injury or death.

- 01. Fail-safe device must be installed when using the unit with machinery that may cause serious injury or substantial economic loss.** (e.g. nuclear power control, medical equipment, ships, vehicles, railways, aircraft, combustion apparatus, safety equipment, crime/disaster prevention devices, etc.)  
Failure to follow this instruction may result in personal injury, economic loss or fire.
- 02. System manager means followings;**  
- a personnel who is fully aware of installation, setting, operation, and maintenance of the product  
- a personnel who well observes standard/regulation/statute on the product by type of machine the product installed in and nation/region the product used in  
Machine user means a personnel who is appropriately trained about using machine by the system manager, so that machine user can operate the machine correctly.  
System manager has duty to train the machine user about operation of the product.  
Machine user has to report directly to the system manager when unusual status has been found while system is operating.  
Failure to follow this instruction may result in personal injury, economic loss or fire.
- 03. The product has to be installed, set, and combined with machine control system by the qualified system manager.**  
Failure to follow this instruction may result in personal injury due to unintended operation and unstable detection.
- 04. Before using the product, check that function of the product operates as intended while machine is turned off after installation.**  
Failure to follow this instruction may result in personal injury due to unintended operation and unstable detection.
- 05. Do not use the unit in the place where flammable/explosive/corrosive gas, high humidity, direct sunlight, radiant heat, vibration, impact, salinity, moisture, or steam, or dust may be present.**  
Failure to follow this instruction may result in explosion or fire.
- 06. Do not disassemble or modify the unit.**  
Failure to follow this instruction may result in personal injury or fire due to loss of safety function.
- 07. Do not connect, repair, inspect, or replace the unit while connected to a power source.**  
Failure to follow this instruction may cause the external devices connected to the product may unexpectedly operate.
- 08. Do not defeat, tamper, modify, or bypass the switch and enter the door.**  
Failure to follow this instruction may result in personal injury.
- 09. Be cautious about the installing place of the operation key in order to protect worker from hitting the operation key when the door is opened.**  
Failure to follow this instruction may result in personal injury.
- 10. Do not use a head of other product.**  
Failure to follow this instruction may result in personal injury or fire due to loss of safety function.
- 11. Install separate safety device to fix door closed, or door can be opened because of vibration or weight of the door.**  
Failure to follow this instruction may result in personal injury.
- 12. Check the installed status of the switch, operating status of the switch, and signs of damage, modification, tampering of the switch at the following situation and on a weekly basis.**  
- when operating the safety system at first  
- when replacing component of the system  
- when the system has not been operated for a long time  
Failure to follow this instruction may result in personal injury due to malfunction of the product and safety function.
- 13. Solenoid Lock/Mechanical Release type switch is locked with power connected and is unlocked without power. Be cautious that the switch can be unlocked before complete stop of the machine when blackout occurs.**  
Failure to follow this instruction may result in personal injury.
- 14. Check 'Connections' before wiring. And make sure that there are no safety problems.**  
Failure to follow this instruction may result in personal injury or fire due to loss of safety function.

**⚠ Caution** Failure to follow instructions may result in injury or product damage.

- 01. Use the unit within the rated specifications.**  
Failure to follow this instruction may result in fire or product damage.
- 02. Since solenoid has polarity, wire cables and supply voltage ensuring correct polarity. Do not supply voltage above the rated voltage specification.**  
Failure to follow this instruction may result in fire or solenoid damage.
- 03. Use a dry cloth to clean the unit, and do not use water or organic solvent.**  
Failure to follow this instruction may result in fire.
- 04. Keep the door switch away from debris and tighten the screw securely when replacing the head.**  
Failure to follow this instruction may result in malfunction.
- 05. Keep the product away from metal chip, dust, and wire residue which might flow into the unit.**  
Failure to follow this instruction may result in fire, product damage or malfunction.
- 06. Do not use metallic cable gland.**  
Failure to follow this instruction may result in electric shock due to the damage on the service entrance.
- 07. Do not use the switch as a guard door stopper. Install separate mechanical stopper.**  
Failure to follow this instruction may result in product damage.
- 08. Carefully manage the spare operation key in order to prevent use of the key without permission.**  
Failure to follow this instruction may result in loss of safety function due to insertion of the spare operation key.
- 09. Use only Autonics operation key.**  
Failure to follow this instruction may result in product damage.
- 10. Install the operation key tightly within the range written in 'Installation' with welding, rivet, or special bolt in order not to be easily released from the switch.**  
Failure to follow this instruction may result in product damage.
- 11. When it comes to the Solenoid Lock/Mechanical Release model, make it to be locked by supplying power after the door is closed.**  
Failure to follow this instruction result in malfunction, if the power is supplied when the door is opened.
- 12. When changing the direction of the head, make sure that the cam inside the head does not rotate.**  
Failure to follow this instruction result in malfunction.
- 13. Do not apply the power over 0.2 N·m on the release key and do not use tools that may apply strong force, such as an electric screwdrivers.**  
Failure to follow this instruction may result in product damage.

## Cautions during Use

- Follow instructions in 'Cautions during Use'. Otherwise, it may cause unexpected accidents.
- Use the switch with the dedicated controller. Do not use the switch with another controller randomly.
- This unit may be used in the following environments.
  - Indoors (in the environment condition rated in 'Specifications')
  - Altitude max. 2,000m
  - Pollution degree 3
  - Installation category III
  - Enclosure Type I

## Product Components

- Product
- Instruction manual
- Special type release key (Special type release key model)

## Sold Separately

- Operation key: SFD-K□□
- Connector cable: SFDL-CND10-□□
- Safety door lock slide unit: SFDL-SD
- Group locking device: SFD-LT□□ / Connecting cable: SFD-LT-C□□

## Ordering Information

This is only for reference, the actual product does not support all combinations. For selecting the specified model, follow the Autonics website.

**SFDL** - ① ② ③ - ④ ⑤ ⑥

### ① Lock/Release method

M: Mechanical Lock/Solenoid Release  
S: Solenoid Lock/Mechanical Release

### ② Contact

No-mark: 4-contct (connected)  
C: 4-contact (not connected)  
5: 5-contact  
6: 6-contact

### ④ Connection type

No-mark: Terminal type  
C: Connector type

### ⑤ Connection outlet specification

M20: M20 thread  
G1/2: G1/2 thread

### ⑥ Release key type

No-mark: Cross type  
K: Special type

### ③ Contact composition

|          | 4-contact                               | 5-contact                                 | 6-contact                               |
|----------|---|---|---|
| <b>A</b> | Lock 1 N.C./1 N.O. + Door 1 N.C./1 N.O. | Lock 1 N.C./1 N.O. + Door N.C. 2 / N.O. 1 | Lock 2 N.C./1 N.O. + Door 2 N.C./1 N.O. |
| <b>B</b> | Lock N.C. 2 + Door N.C. 1 / N.O. 1      | Lock N.C. 2 + Door N.C. 2 / N.O. 1        | Lock N.C. 3 + Door N.C. 2 / N.O. 1      |
| <b>C</b> | Lock N.C. 1 / N.O. 1 + Door N.C. 2      | Lock N.C. 1 / N.O. 1 + Door N.C. 3        | Lock N.C. 2 / N.O. 1 + Door N.C. 3      |
| <b>D</b> | Lock N.C. 2 + Door N.C. 2               | Lock N.C. 2 + Door N.C. 3                 | Lock N.C. 3 + Door N.C. 3               |

## Dimensions

- Unit: mm, For the detailed dimensions of the product, follow the Autonics web site.

### Terminal type

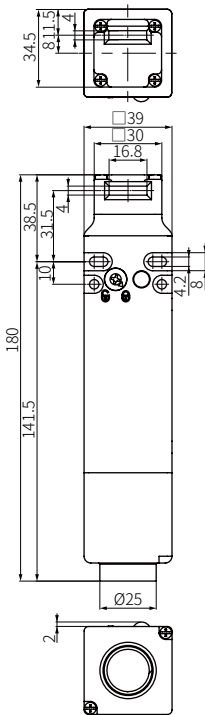

### Connector type

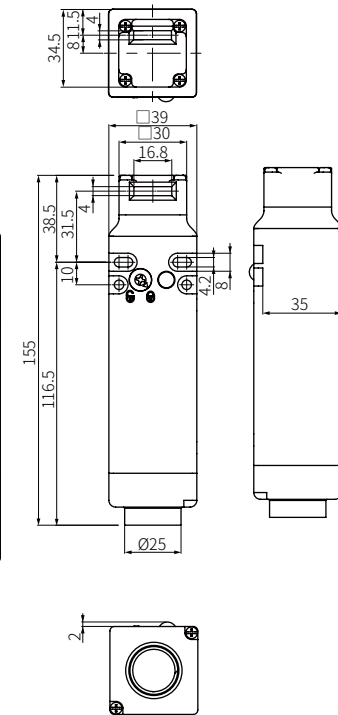

### Panel cut out

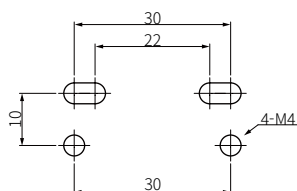

## Specifications

| Model                      | SFDL-□□□-□□  | SFDL-□□□-C□□      |
|----------------------------|--|-------------------|
| Directing opening force    | ≥ 80 N   |                   |
| Directing opening distance | ≥ 10 mm  |                   |
| Locking pullout strength   | ≥ 1,300 N  |                   |
| Operating speed            | 0.05 to 1 m/s  |                   |
| Operating frequency        | ≤ 20/min   |                   |
| Mechanical life cycle      | ≥ 1,000,000 operations (20/min)  |                   |
| Vibration (malfunction)    | 0.35mm amplitude at frequency of 10 to 55 Hz in each X, Y, Z direction for 10 min              |                   |
| Shock                      | 1,000 m/s <sup>2</sup> (≈ 100 G) in each X, Y, Z direction for 3 times                         |                   |
| Shock (malfunction)        | 80 m/s <sup>2</sup> (≈ 8 G) in each X, Y, Z direction for 3 times                              |                   |
| Ambient temperature        | -10 to 55°C <sup>01)</sup> , storage: -25 to 65°C (a non freezing or condensation environment) |                   |
| Ambient humidity           | 35 to 85%RH, storage: 35 to 85%RH (a non freezing or condensation environment)                 |                   |
| Protection structure       | IP67 <sup>02)</sup> (IEC standard, except for head)  |                   |
| Material                   | Head: zinc, case: polyamide 66, operation key: stainless steel 304                             |                   |
| Approval                   | CE (TUV NORD)  |                   |
| Accessory                  | SFDL-□□□-□□□K (Special type release key) : rotating key  |                   |
| Applicable cable           | AWG22  | -                 |
| Connection type            | Terminal type  | Connector type    |
| Unit weight (packaged)     | ≈ 375 g (≈ 440 g)  | ≈ 325 g (≈ 395 g) |

01) UL approved ambient temperature: 50°C

02) Rated protection structure is for the switch body. Be cautious about preventing the head part from entering the foreign materials such as dust and water.

### Contact block

|                                   |   |
|-----------------------------------|---|
| Rated voltage/current for load    | Resistive load: 1 A/120 VAC~, 0.22 A/125 VDC=<br>Inductive load (IEC): AC-15 1 A/120 VAC~, DC-13 0.22 A/125 VDC=<br>Inductive load (UL): C150, R150     |
| Impulse dielectric strength       | Between the terminals of same polarity: 1.5 kV<br>Between the terminals of different polarity: 1.5 kV<br>Between each terminal and non-live part: 2.5kV |
| Insulation resistance             | ≥ 100 MΩ (500 VDC= megger)  |
| Contact resistance                | ≤ 200 mΩ  |
| Electrical life cycle             | ≥ 100,000 operations (125 VAC~/1 A)   |
| Conditional short-circuit current | 100 A   |
| <b>Solenoid</b>                   |   |
| Rated voltage                     | 24 VDC=, class 2  |
| Current consumption               | Supplying power: 0.26A<br>Normal: max. 0.2A (approx. 3 seconds after supplying power)   |
| Insulation class                  | Class E   |

## Installation

- The head of the switch can be rotated by loosening the four screws from the corners of the head and reinstalling the head in the desired orientation.
- Be sure to install the switch with the minimum radius at a hinged door as shown in the table. For more information about operation keys, refer to the product manual.

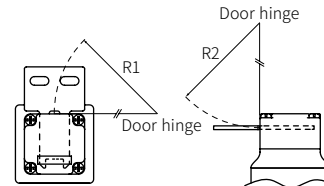

| Operation key | Minimum radius |        |
|---------------|----------------|--------|
|               | R1             | R2     |
| SFD-KH        | 300 mm         | 300 mm |
| SFD-KL        |                |        |
| SFD-KHR       |                |        |
| SFD-KLR       |                |        |
| SFD-KLF       | 50 mm          | 300 mm |
| SFD-KLF2      |                |        |

- Inspect the inserted operation key remains within the set zone (0.5 to 3 mm).
- Install the operation key within ± 1 mm from the center of the operation key hole (SLOT).

Set zone: 0.5 to 3 mm

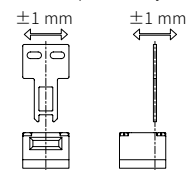
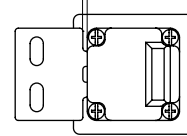

- Recommended screw tightening torque
- Cable gland specification and recommended product

| Screw                    | Tightening torque |
|--------------------------|-------------------|
| Terminal screw           | 0.4 N m           |
| Head mounting screw (M3) | 0.7 to 0.8 N m    |
| Bottom cover             | 0.5 to 0.7 N m    |
| Cable gland              | 2.7 to 3.3 N m    |

| Thread spec | MFR       | Model                  | Cable Ø     |
|-------------|-----------|------------------------|-------------|
| G1/2        | CP SYSTEM | FCGL-G12B              | 4 - 8 mm    |
|             |           | FCGL-G16B              | 7 - 12.3 mm |
| M20         | LAPP      | ST-M20X1.5 / 5311-1020 | 6 - 13 mm   |

In case of using the cable gland with the 9 mm screw thread or longer, a gap between the switch and cable may affect the protection structure.

## Release Key

| Release key  | Normal | Manual unlock |
|--------------|--------|---------------|
| Cross type   |        |               |
| Special type |        |               |

- You can manually unlock the switch in the emergency situation such as blackout, when wiring, before supplying power, or when testing operation of the switch.
- When using the release key, turn it to the marked position completely. Otherwise (under 90°), switch can be damaged or malfunction.

## Contact Composition and Operation

Connection diagram represents the locked status with the operation key inserted.

■: ON, □: OFF

⊖: Direct opening action possible

| Model      | Contact (lock monitor+ door monitor) | Connection diagram |              | Contact operation   |
|------------|--------------------------------------|--------------------|--------------|---|
|            |                                      | Lock monitor       | Door monitor |   |
|            |                                      |                    |              | Operation key complete insertion: ; Operation key extraction: |
| SFDL□A□□□  | 1N.C./1N.O.+ 1N.C./1N.O.             |                    |              | Lock position:  |
| SFDL□B□□□  | 2N.C.+1N.C./1N.O.                    |                    |              | Lock position:  |
| SFDL□C□□□  | 1N.C./1N.O.+2N.C.                    |                    |              | Lock position:  |
| SFDL□D□□□  | 2N.C.+2N.C.                          |                    |              | Lock position:  |
| SFDL□CA□□□ | 1N.C./1N.O.+ 1N.C./1N.O.             |                    |              | Lock position:  |
| SFDL□CB□□□ | 2N.C.+1N.C./1N.O.                    |                    |              | Lock position:  |
| SFDL□CC□□□ | 1N.C./1N.O.+2N.C.                    |                    |              | Lock position:  |
| SFDL□CD□□□ | 2N.C.+2N.C.                          |                    |              | Lock position:  |
| SFDL□5A□□□ | 1N.C./1N.O.+ 2N.C./1N.O.             |                    |              | Lock position:  |
| SFDL□5B□□□ | 2N.C.+2N.C./1N.O.                    |                    |              | Lock position:  |
| SFDL□5C□□□ | 1N.C./1N.O.+3N.C.                    |                    |              | Lock position:  |
| SFDL□5D□□□ | 2N.C.+3N.C.                          |                    |              | Lock position:  |
| SFDL□6A□□□ | 2N.C./1N.O.+ 2N.C./1N.O.             |                    |              | Lock position:  |
| SFDL□6B□□□ | 3N.C.+2N.C./1N.O.                    |                    |              | Lock position:  |
| SFDL□6C□□□ | 2N.C./1N.O.+3N.C.                    |                    |              | Lock position:  |
| SFDL□6D□□□ | 3N.C.+3N.C.                          |                    |              | Lock position:  |

## Wiring

### Terminal block board

- With the power disconnected, separate the terminal block board from the connector of the main body and wire it.
- Unscrew the 2 bolts on the bottom cover and connect the wires on the terminal block board.
- After wiring is complete, be sure to firmly insert the connector.
- When wiring the terminal block, use AWG 22 to 18 (0.3 to 0.75 mm<sup>2</sup>) and tighten the terminal block screw with a torque of 0.4 N·m.
- Do not wire stranded wires directly to the terminal block.

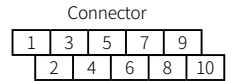

### Wire Ferrule Specification

- Unit: mm, Use the UL approved wire ferrule.

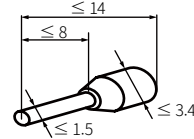

### Sold Separately: Connector Cable (SFDL-CND10-□)

- Connector cable is the separately sold accessory for the connector type model.

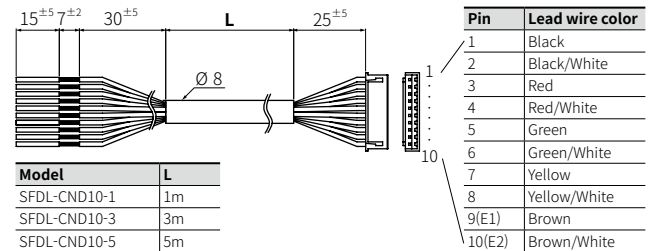

| Model        | L  |
|--------------|----|
| SFDL-CND10-1 | 1m |
| SFDL-CND10-3 | 3m |
| SFDL-CND10-5 | 5m |

### Connector specification

| Type               | Model         | Manufacture |
|--------------------|---------------|-------------|
| Housing            | XHP-10        | JST         |
| Contact (AWG24-22) | SXH-001T-P0.6 |             |

## Sold Separately: Operation Key (SFD-K□)

• Unit: mm, For the detailed dimensions of the product, follow the Autonics web site.

### ■ SFD-KH

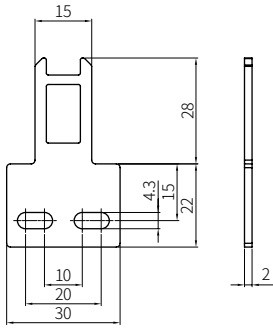

### ■ SFD-KL

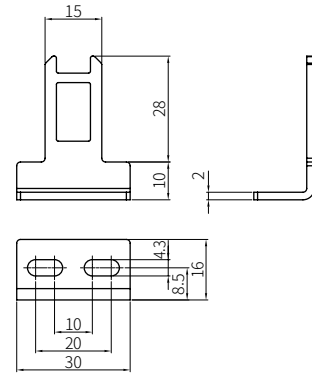

### ■ SFD-KHR

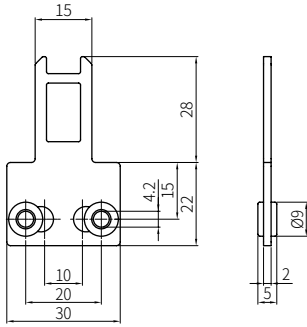

### ■ SFD-KLR

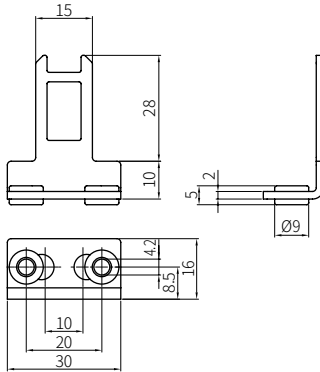

### ■ SFD-KLF, SFD-KLF2

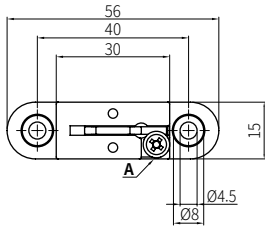

- When installing the switch on a hinged door, turn the angle adjustment screw to adjust the inclination of the control key toward the door hinge.

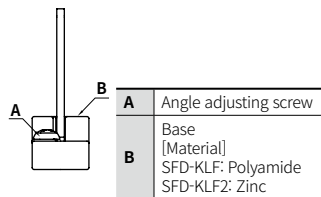
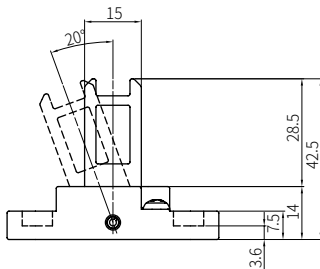
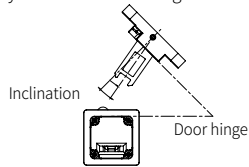

## Sold Separately: Group Locking Device (SFT-LT□) / Connecting Cable (SFD-LT-C□)

| Model                              | SFD-LT   | SFD-LT2              |
|------------------------------------|--|----------------------|
| Type                               | Side inserted type   | Upside inserted type |
| Head material of the applied model | Metal  |                      |
| Padlock ring diameter              | Ø 5 to 7 mm  |                      |
| Load                               | Max. 30 N  |                      |
| Shock                              | 300 m/s <sup>2</sup> (≈ 30 G) X, Y, Z direction for 3 times                        |                      |
| Vibration                          | 0.35 mm amplitude at frequency of 10 to 55 Hz in each X, Y, Z direction for 10 min |                      |

### ■ Side inserted type: SFD-LT

• Unit: mm, For the detailed dimensions of the product, follow the Autonics web site.

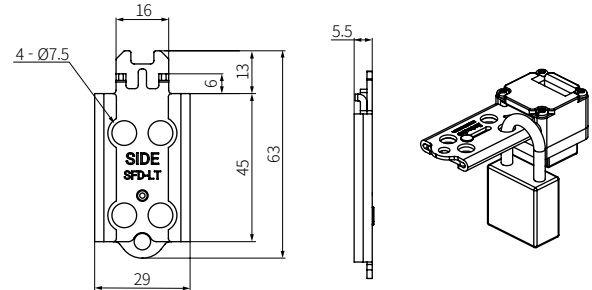

### ■ Upside inserted type: SFD-LT2

• Unit: mm, For the detailed dimensions of the product, follow the Autonics web site.

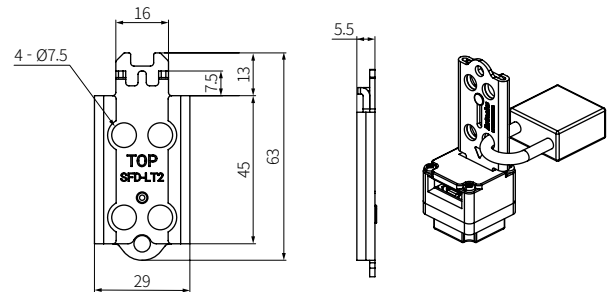

### ■ Cautions

- Head material: Use for the metal head of applied models.
- Select the padlock locked in the group locking device to be less than 2 kg. Failure to follow this instruction may result in product or safety switch damage.
- Do not apply excessive shock and vibration while installed in the group locking device. Failure to follow this instruction may result in product or safety switch damage.
- Install the group locking device to prevent interrupting other nearby devices.
- Fasten the group locking device in the correct direction.

#### SFD-LT

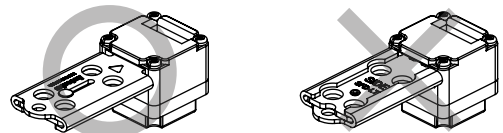

#### SFD-LT2

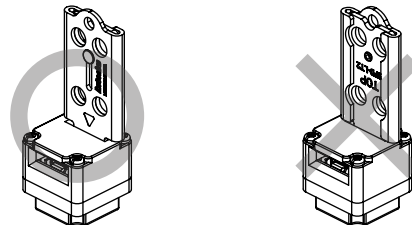

## ■ Installation

- This is the installation example of the side inserted type.

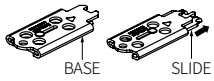

1. Push the SLIDE of the group locking device forward in the direction.

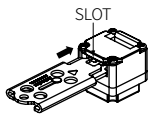

2. Insert the SLIDE into the operation key hole (SLOT).

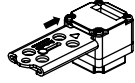

3. Push the BASE to the operation key hole (SLOT) to be fixed stably.

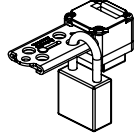

4. Fix the group locking device by fastening the padlock to its hole.

## ■ Group locking device connecting cable: SFD-LT-C□

- It is possible to prevent loss of the group locking device with the connecting cable(SFD-LT-C□).
- Unit: mm, For the detailed dimensions of the product, follow the Autonics web site.

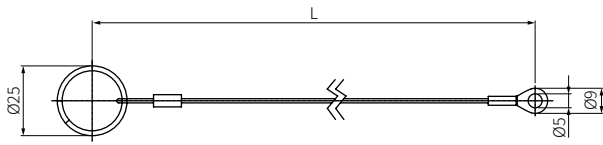

| Model      | Length (L) |
|------------|------------|
| SFD-LT-C20 | 200        |
| SFD-LT-C30 | 300        |
| SFD-LT-C40 | 400        |