

WaterMaster FET100

Electromagnetic flowmeter/transmitter

Hazardous areas ATEX/UKEX/IECEX areas 2, 21 and 22



Measurement made easy

WaterMaster FET100 flowmeter transmitter

Introduction

WaterMaster™ is a range of high performance electromagnetic flowmeters for the measurement of electrically-conductive fluids and systems are normally supplied factory-configured and calibrated.

This User Guide provides installation, connection, commissioning and maintenance details for ATEX/UKEX/IECEX option flowmeter and must be read in conjunction with the standard User Guides ([OI/FET100-EN](#) and [OI/FEF/FEV/FEW-EN](#)).

For programming and configuration information refer to the Programming Guide – [IM/WMP](#).

For a comprehensive overview of publications available for the WaterMaster transmitter (including links) refer to the inside cover.

For more information

Further publications are available for free download from www.abb.com/flow or by scanning this code:



Search for or click on

Data Sheet WaterMaster Electromagnetic flowmeter	DS/WM-EN
User Guide WaterMaster FET100 Electromagnetic flowmeter transmitter	OI/FET100-EN
User Guide F, V, W Series Electromagnetic flowmeter Full-bore flow sensors	OI/FEF/FEV/ FEW-EN
Programming Guide WaterMaster Electromagnetic flowmeter	IM/WMP

Related documents

WaterMaster flowmeter (FET100)

Search for or click on

Programming Guide
WaterMaster
Electromagnetic flowmeter

[IM/WMP](#)

User Guide
WaterMaster FET100
Electromagnetic flowmeter transmitter

[OI/FET100-EN](#)

User Guide
F, V, W Series
Electromagnetic flowmeter | Full-bore flow sensors

[OI/FEF/FEV/FEW-EN](#)

User Guide Supplement
WaterMaster FEX100-MB
Electromagnetic flowmeter | MODBUS RS485 Physical Layer

[COI/FEX100/MOD-EN](#)

MODBUS Tables Supplement
WaterMaster
Electromagnetic flowmeter

[COI/FEX100/MOD/TBL-EN](#)

User Guide Supplement
WaterMaster
Electromagnetic flowmeter | PROFIBUS RS485 Physical Layer (FEX100-DP)

[IM/WMPBS-EN](#)

User Guide Supplement
WaterMaster
Electromagnetic flowmeter | PROFIBUS FEX100-DP parameter tables

[IM/WMPBST-EN](#)

- 1 Safety 2**
 - 1.1 General safety information 2
 - 1.2 Intended use 2
 - 1.3 Improper use 2
 - 1.4 Labels and symbols 3
 - 1.5 Transport safety information 3
 - 1.6 Specific conditions of use 3
 - 1.7 Installation safety information 3
 - 1.8 Electrical installation safety information 4
 - 1.9 Operating safety information 4
 - 1.10 Maintenance and inspection safety information 4
 - 1.11 Operator liability 4

- 2 Device designs 5**
 - 2.1 Integral design – ATEX/UKEX/IECEx Zones 2, 21 and 22 5
 - 2.2 Remote design – ATEX/UKEX/IECEx Zones 2, 21 and 22 6
 - 2.3 Nameplate 7
 - 2.3.1 Sensor nameplate 7
 - 2.3.2 Transmitter nameplate 8

- 3 Installation 9**
 - 3.1 General information on installation 9
 - 3.2 Installation requirements – sensor 9
 - 3.3 Connecting the flowmeter sensor 10
 - 3.3.1 Protection class IP68 10
 - 3.3.2 Sensor cable connections 10
 - 3.3.3 Environmental protection 11
 - 3.3.4 Protection for mechanical input 11
 - 3.3.5 Protection from static 12
 - 3.3.6 Information about using the device in areas with combustible dust 12
 - 3.3.7 Maximum allowable surface temperature 12
 - 3.4 Transmitter terminal connections 13
 - 3.5 Cable preparation (remote systems only) 14
 - 3.6 Transmitter / Sensor cable connections 15
 - 3.6.1 Sensor cable terminal connections and recommended cable lengths 15
 - 3.7 Cable rating 16
 - 3.8 Input / Output connections 16
 - 3.9 Power supply connections 16
 - 3.9.1 AC power supply 17
 - 3.9.2 DC (and low voltage AC) power supply 18
 - 3.10 Refitting the cartridge and cover 19

- 4 Ratings 20**
 - 4.1 Electrical data 20
 - 4.2 Temperature values 20

- 5 Commissioning 21**
 - 5.1 Preliminary checks prior to start-up 21

- 6 Maintenance 21**
 - 6.1 General information 21
 - 6.2 Flowmeter sensor – remote sensor 21
 - 6.3 Flowmeter transmitter – cartridge 22
 - 6.3.1 Cartridge replacement 23
 - 6.3.2 Fuse replacement 23
 - 6.3.3 Refitting the cartridge and cover 23

- Appendix A – Approvals and certifications 24**
 - A.1 Approvals 24
 - A.2 Certifications 25

1 Safety

1.1 General safety information

The 'Safety' chapter provides an overview of the safety aspects to be observed for the operation of the device. The device is based on state-of-the-art technology and is operationally safe. It was tested and left the factory in a proper state. The requirements in the manual as well as the documentation and certificates must be observed and followed in order to maintain this state for the period of operation.

The general safety requirements must be complied with completely during operation of the device. In addition to the general information, the individual chapters of this manual contain descriptions about processes or procedural instructions with specific safety information.

Only the observance of all safety information enables the optimal protection of personnel as well as the environment from hazards and the safe and trouble-free operation of the device.

1.2 Intended use

This device is intended for the following uses:

- To transmit fluids with electrical conductivity.
- To measure the flowrate of the fluids.

The following items are included in the intended use:

- Read and follow the instructions in this manual.
- Observe the technical ratings; refer to the Specification section in OI/FET100-EN.
- Use only allowed liquids for measurement which is water or waste water. Flammable liquids are not permitted.







1.3 Improper use

The following uses of the device are prohibited:

- Operation as a flexible adapter in piping, for example, to compensate for pipe offsets, pipe vibrations, pipe expansions, etc.
- Use as a climbing aid, for example, for assembly purposes.
- Use as a support for external loads, for example, as a support for pipes, etc.
- Material gain, for example, by painting over the name plate or adding parts by welding / soldering.
- Material loss, for example, by drilling the housing.

Repairs, alterations and enhancements or the installation of replacement parts is only permissible as far as described in the manual. Further actions must be verified with ABB Limited. Excluded from this are repairs performed by ABB-authorized specialist shops.

1.4 Labels and symbols

 	<p>Danger – serious damage to health / risk to life One of these symbols in conjunction with the 'Danger' warning indicates an imminent danger. If it is not avoided, death or serious injury will result.</p>
	<p>Warning – bodily injury The symbol in conjunction with the 'Warning' message indicates a possibly dangerous situation. If it is not avoided, death or serious injury could result.</p>
	<p>Caution – slight injuries The symbol in conjunction with the 'Caution' message indicates a possibly dangerous situation. If it is not avoided, slight or minor injury can result. May also be used for property damage warnings.</p>
	<p>Notice – property damage The symbol indicates a possibly damaging situation. If it is not avoided, the product or something in its area can be damaged.</p>
	<p>Important The symbol indicates operator tips or especially useful information. This is not a message for a dangerous or damaging situation.</p>

1.5 Transport safety information

Observe the following information:

- Depending on the device, the center of gravity may not be in the center of the equipment.
- To prevent possible leakage, make sure that the liner on the flange is not cut or damaged.

1.6 Specific conditions of use

- Suitable precautions to prevent mechanical damage to the remote terminal housing shall be taken if the enclosure is to be installed in an area of high mechanical danger.
- The non-metallic material of the remote terminal housing may store electrostatic charge and become a source of ignition in applications with a low relative humidity <~30% relative humidity where the surface is relatively free of surface contamination such as dirt, dust, or oil. Guidance on protection against the risk of ignition due to electrostatic discharge can be found in EN TR50404 and IEC TR60079-32 (in preparation). Cleaning of the surface should only be done with a damp cloth.
- The temperature at the entry point of the transmitter and remote sensor under rated conditions is higher than 70 °C. Cables rated for 100°C should be used.

1.7 Installation safety information

Observe the following instructions:

- Install the devices without mechanical tension (torsion, bending).
- Only install devices for the intended operating conditions and with suitable seals.
- Secure the flange bolts and nuts against pipeline vibrations.

1.8 Electrical installation safety information

The electrical connection may only be performed by authorized specialists according to the electrical plans. Comply with electrical connection information in the manual. Otherwise, the electrical protection can be affected.

Cross bond the flowmeter to the upstream and downstream pipelines.

The cable for the supply power must be installed according to the relevant national and international standards. A separate fuse and switch must be used for each unit. The fuses and switch must be identified accordingly. The unit has a protection class of I and overvoltage class II (IEC664).

The power supply and the electrical circuit for the coils of the sensor are dangerous and pose a contact risk.

Never attempt electrical connection unless the power is OFF and isolated.

The coils and signal circuit can be connected with ABB sensors only. Use the supplied cable.

Only electrical circuits that do not pose a contact risk can be connected to the remaining signal inputs and outputs.

1.9 Operating safety information

During operation with hot fluids, contact with the surface may result in burns.

A pressurized fluid may escape due to wear on the flange seal or process connection gaskets.

1.10 Maintenance and inspection safety information



Warning – risk to persons When the housing cover is open, EMC and protection against contact are suspended. There are electric circuits within the housing which pose a contact risk.
The auxiliary power must be switched off before opening the housing cover.

Corrective maintenance work may only be performed by trained personnel.

- Depressurize the device and adjoining lines or containers before removing the device.
- As far as provided in the scope of the operational responsibility, check the following items through a regular inspection:
 - the pressure-carrying walls / lining of the pressure device
 - the measurement-related function
 - the leak tightness
 - the wear (corrosion)

1.11 Operator liability

The operator must strictly observe the applicable national regulations with regard to installation, function tests, repairs, and maintenance of electrical devices.

When operating the meter with combustible dusts, it is essential to comply with IEC 60079-31 and IEC 60079-14.

The safety instructions for electrical apparatus in potentially explosive areas must be complied with, in accordance with ATEX Directive 2014/34/EU and IEC60079-14 (Installation of equipment in potentially explosive atmospheres).

To ensure safe operation, the requirements of EU Directive ATEX 118a (minimum requirements concerning the protection of workers) must be met.

WaterMaster FET100

Electromagnetic flowmeter / transmitter | Hazardous areas ATEX/UKEX/IECEX, Zones 2, 21 and 22

2 Device designs

Devices suitable for use in potentially explosive atmospheres feature the corresponding Ex mark on their name plates.

The design intended for use in Ex Zones 2, 21, and 22 is identified by the letter 'M' in the model number.

Example:

FEV1315-100A1S1D2BOA1AOM1A1C1, FEW325-100A1S1D280A1A1M1AOY1,

FET125-1AOM1A1C1

2.1 Integral design – ATEX/UKEX/IECEX Zones 2, 21 and 22

The transmitter and the flowmeter sensor form a single mechanical entity.

WaterMaster
In Ex Zones 2, 21, 22
FEV115, FEW115, FEW315, FEF115 (M in the model number identifies zone – see Example model number [Section 2] above)

ATEX/UKEX Certificate: FM10ATEX0036X FM10ATEX0037X FM21UKEX0008X FM21UKEX0009X II 3 G Ex nA IIC T5 Gc, Ta= -20 to +60 °C II 2 D Ex tb IIIC T100°C Db Ta= -20 to +60 °C
IECEX Certificate: FME10.0006X Ex nA IIC T5 Gc, Ta= -20 to +60 °C Ex tb IIIC T100°C Db Ta= -20 to +60 °C

Table 2.1 Integral design – ATEX/UKEX/IECEX Zones 2, 21 and 22

WaterMaster FET100

Electromagnetic flowmeter / transmitter | Hazardous areas ATEX/UKEX/IECEX, Zones 2, 21 and 22

2.2 Remote design – ATEX/UKEX/IECEX Zones 2, 21 and 22

The transmitter is mounted at a separate location from the sensor. The electrical connection between the transmitter and the sensor is provided by ABB-approved signal cable. The maximum permitted cable length is 200 m (656 ft.).



WaterMaster	
In Ex area, Zones 2, 21, 22	
<p>FEV125, FEV185 FEW125, FEW185 FEW325, FEW385 FEF125, FEF185</p> <p>(M in the model number identifies zone – see Example model number [Section 2])</p>	<p>FET125.....M....</p> <p>(M in the model number identifies zone – see Example model number [Section 2])</p>
	
<p style="text-align: center;">ATEX/UKEX</p> <p style="text-align: center;">Certificate: FM10ATEX0036X FM10ATEX0037X FM21UKEX0008X FM21UKEX0009X</p> <p style="text-align: center;">II 3 G Ex nA IIC T5 Gc, Ta= -20 to +70 °C II 2 D Ex tb IIIC T100°C Db Ta= -20 to +70 °C</p>	<p style="text-align: center;">ATEX/UKEX</p> <p style="text-align: center;">Certificate: FM10ATEX0036X FM10ATEX0037X FM21UKEX0008X FM21UKEX0009X</p> <p style="text-align: center;">II 3 G Ex nA IIC T5 Gc II 2 D Ex tb IIIC T100°C Db Ta= -20 to +60 °C</p>
<p style="text-align: center;">IECEX</p> <p style="text-align: center;">Certificate: FME10.0006X Ex nA IIC T5 Gc, Ta= -20 to +70 °C Ex tb IIIC T100°C Db Ta= -20 to +70 °C</p>	<p style="text-align: center;">IECEX</p> <p style="text-align: center;">Certificate: FME10.0006X Ex nA IIC T5 Gc / Ex tb IIIC T100°C Ta= -20 to +60 °C</p>

Table 2.2 Remote design – ATEX/UKEX/IECEX Zones 2, 21 and 22

2.3 Nameplate

2.3.1 Sensor nameplate

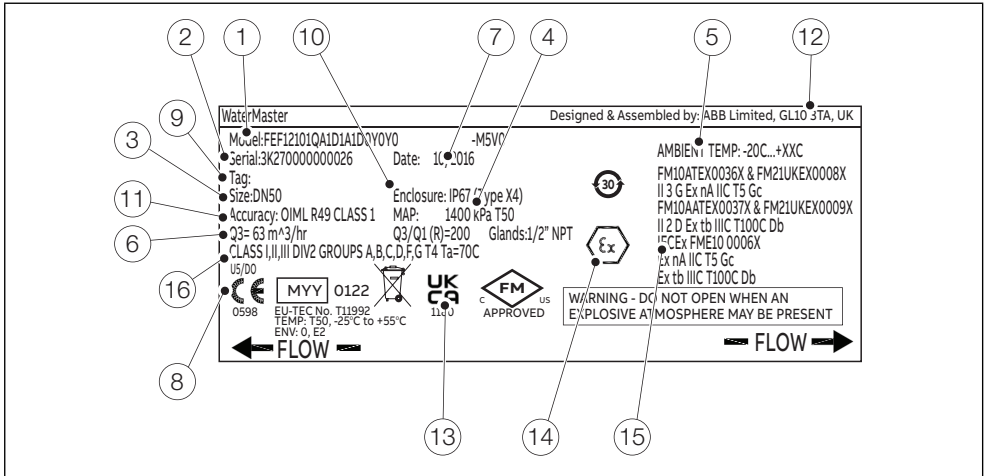

Fig. 2.1 Example of sensor nameplate

①	Model number (for more detailed information about the technical design, refer to the data sheet or the order confirmation)	⑨	Client -specific TAG number (if specified)
②	Serial number	⑩	Protection type according to EN 60529
③	Meter size	⑪	Accuracy to which the unit was calibrated
④	Maximum admissible pressure	⑫	Approval licence holder / manufacturing location
⑤	Tamb = maximum permissible ambient temperature	⑬	UKCA mark (example)
⑥	Flow specification	⑭	Ex mark according to ATEX (example)
⑦	Year of manufacture	⑮	Ex mark according to IECEx (example)
⑧	CE Mark	⑯	Ex mark according to cFM (example)

Table 2.3 Key to sensor nameplate

2.3.2 Transmitter nameplate

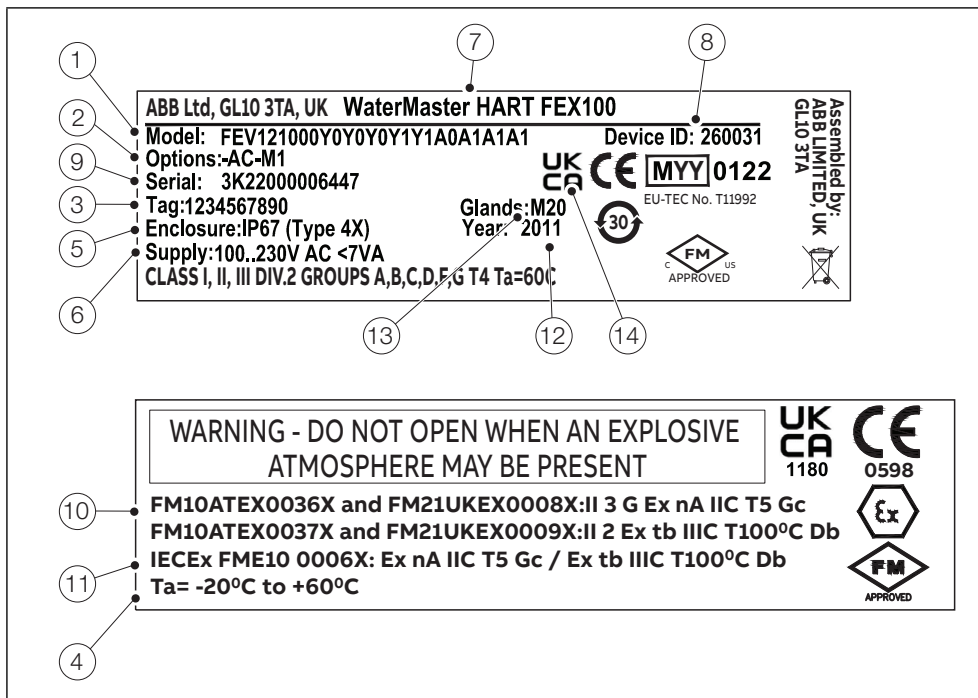

Fig. 2.2 Example of transmitter nameplate

①	Model number (for more detailed information about the technical design, refer to the data sheet or the order confirmation)	⑧	Software ID
②	Order options	⑨	Serial number
③	Client -specific TAG number (if specified)	⑩	Ex mark according to ATEX/UKEX (example)
④	Permissible ambient temperature	⑪	Ex mark according to IECEx (example)
⑤	Protection type according to EN 60529	⑫	Year of manufacture
⑥	Supply voltage	⑬	Entry gland thread
⑦	Communications protocol of transmitter	⑭	UKCA mark (example)

Table 2.4 Key to transmitter nameplate

3 Installation

3.1 General information on installation

The following points must be observed for the installation:

- The flow direction must correspond to the identification if present.
- The devices must be installed without mechanical tension (torsion, bending).
- Install flange sensor with appropriate gaskets.
- Use only gaskets made from a compatible material for the fluid and fluid temperatures.
- Gaskets must not extend into the flow area since possible turbulence could influence the device accuracy.
- The pipeline may not exert excessive forces or torques on the device.
- Do not remove the plugs in the cable connectors until you are ready to install the electrical cable.
- Make sure the gaskets for the housing covers are seated properly. Carefully seal the cover. Tighten the cover fittings.
- A separate transmitter must be installed at a largely vibration-free location.
- Do not expose the transmitter and sensor to direct sunlight. Provide appropriate sun protection if necessary.
- When installing the transmitter in a control cabinet, make sure adequate cooling is provided.
- Cable glands to be used with the transmitter and remote housing shall meet the requirements of EN 60079-0 and be installed such as to maintain a minimum Degree of Protection IP54 when used as EPL Gc or Category II 3 G equipment and IP6X when used as EPL Db or Category II 2 D equipment.

**Warning – risk to persons**

The transmitter and the sensor are for use in Non-hazardous Areas or in Hazardous Areas Zone 2 suitable.

3.2 Installation requirements – sensor

Refer to the full-bore sensors User Guide (OI/FEF/FEV/FEW-EN).

3.3 Connecting the flowmeter sensor

3.3.1 Protection class IP68

For sensors with protection class IP 68, the maximum flooding height is 10 m (33 ft.). The supplied cable complies with submersion requirements.

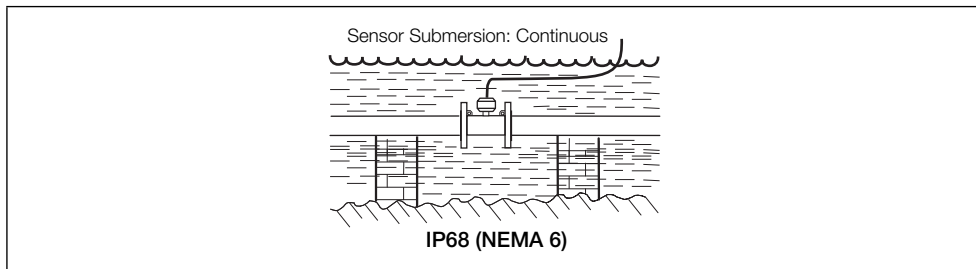

Fig. 3.1 Sensor submersion

3.3.2 Sensor cable connections

Caution.

- Use the supplied cable to connect the sensor to the transmitter (rating 100 °C [212 °F]).
- Make connections only as shown.
- Twist the screen wire of D1 / TFE + D2 with the outer screen drain wire and sleeve them green / yellow.
- Ensure the seal and mating surfaces are clean to maintain environmental rating.
- Conduit connections must provide cable entry sealing.
- Ensure cable glands are tightened after wiring. Do not overtighten the plastic cable glands to avoid destroying their sealing properties. Initially, tighten finger-tight, then a further 1/2 to 3/4 turn using a suitable spanner or wrench.

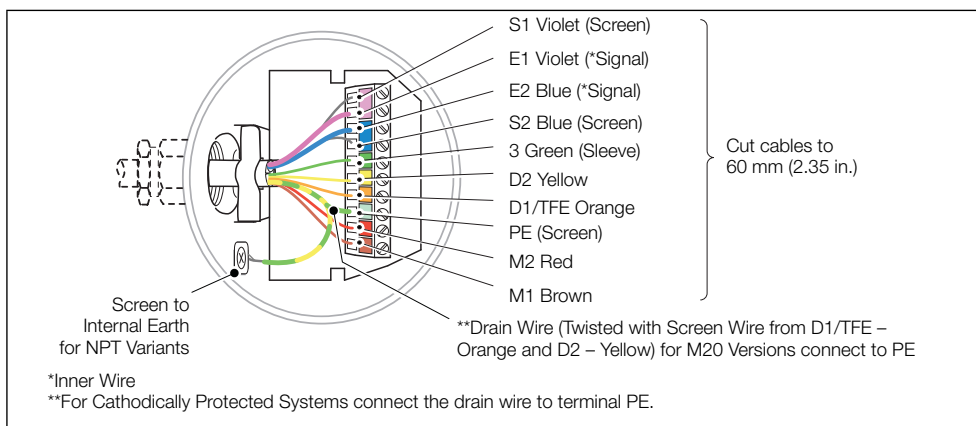

Fig. 3.2 Sensor cable connections – WaterMaster transmitter

3.3.3 Environmental protection

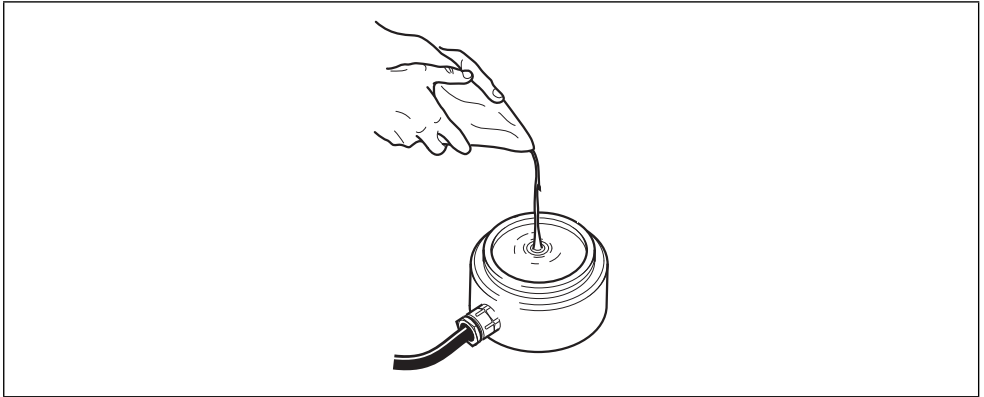

Fig. 3.3 Potting the sensor terminal box

	<ul style="list-style-type: none">■ Potting materials are toxic. Read the manufacturers' instructions carefully before preparing the potting material and use suitable safety precautions.■ Power up and check all connections before potting.■ The remote sensor terminal box connections must be potted immediately on completion to prevent the ingress of moisture.■ Do not overfill or allow the potting material to come into contact with 'O' rings or grooves.■ Do not let potting material enter conduit (if used).
	<p>Notice – potentially adverse effect on IP 68 protection class</p> <p>The sensor's IP 68 protection class may be compromised by damage to the signal cable. The sheathing of the signal cable must not be damaged. Otherwise, the protection class IP 68 for the sensor cannot be ensured.</p>
	<p>Important</p> <p>As an option, the sensor can be ordered with signal cable already connected and a potted terminal box.</p>

3.3.4 Protection for mechanical input

	<p>Risk of explosion</p> <p>The sensor terminal box is manufactured from plastic that has passed the ATEX/UKEX/IECEX impact tests at the lower level permitted in the standards. As a consequence, in ATEX/UKEX/IECEX Zone 2, 21 and 22 locations the terminal box must be located in an area of low mechanical risk (4J input maximum). The remote terminal enclosure is only considered suitable for installation in areas with low risk of mechanical danger. Suitable precautions to prevent mechanical damage to the remote terminal housing shall be taken if the enclosure is to be installed in an area of high mechanical danger.</p>
--	---

3.3.5 Protection from static

	Risk of explosion
The sensor terminal box is made from an insulating plastic that, under certain conditions, such as a low relative humidity (<30 %) and where the surface is relatively free of surface contamination such as dirt, dust, or oil could generate electrostatic charges. These charges are a source of ignition and therefore pose a hazard in some applications due to electrostatic charging. Cleaning of the surface must only be done with a damp cloth.	

3.3.6 Information about using the device in areas with combustible dust

The device is approved for use in potentially explosive areas (gas and dust).

The Ex certification is provided on the name plate.

	Risk of explosion
The dust explosion protection is also provided by the housing. Modifications to the housing are not allowed (for example, removing or omitting parts).	

3.3.7 Maximum allowable surface temperature

Model name	Maximum surface temperature
FEV115, FEF115, FEW115, FEW315	T70 °C (158 °F) ... T _{medium}
FET125	T70 °C (158 °F)

Table 3.1 Maximum allowable surface temperature

The maximum surface temperature is applicable to dust layers of up to 5 mm (0.20 in.) in thickness. The minimum permissible ignition and smoldering temperatures of the dust atmosphere should be calculated in accordance with IEC 60079-31 and IEC 60079-14.

With thicker dust layers, the maximum permissible surface temperature must be reduced. The dust can be conductive or non-conductive. IEC 60079-31 and IEC 60079-14 must be observed.

3.4 Transmitter terminal connections



Warning – serious damage to health / risk to life



Isolate the transmitter from power supplies before removing the cover.

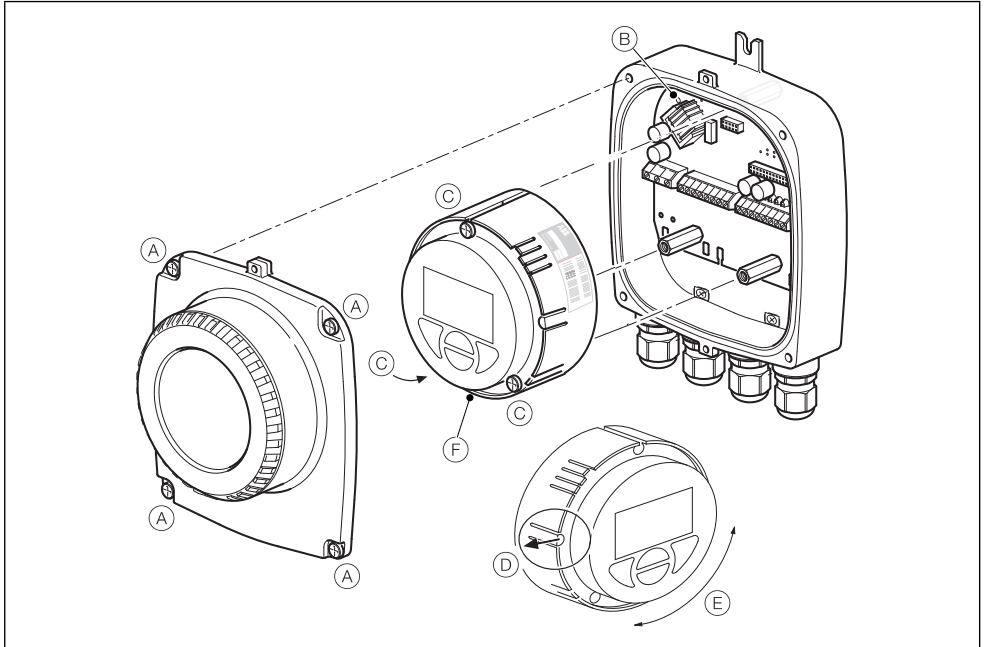

Fig. 3.4 Accessing the Transmitter Terminals

Referring to Fig. 3.4:

1. Slacken (but do not remove) the four transmitter cover screws (A).
2. Remove the transmitter cover.
3. Check that the power indicator LED (B) on the backplane is **not** lit.



Warning – serious damage to health / risk to life

If the power indicator LED (B) is lit, the transmitter is still powered up. Before continuing, isolate the transmitter power supply.

4. If screws (C) are not visible, access them by gently pulling the rotation lock (D) back and rotating the cartridge (E) until the cartridge screw access holes align with the cartridge screw heads.
5. Slacken the three cartridge screws and lift the cartridge (F) away from the housing.

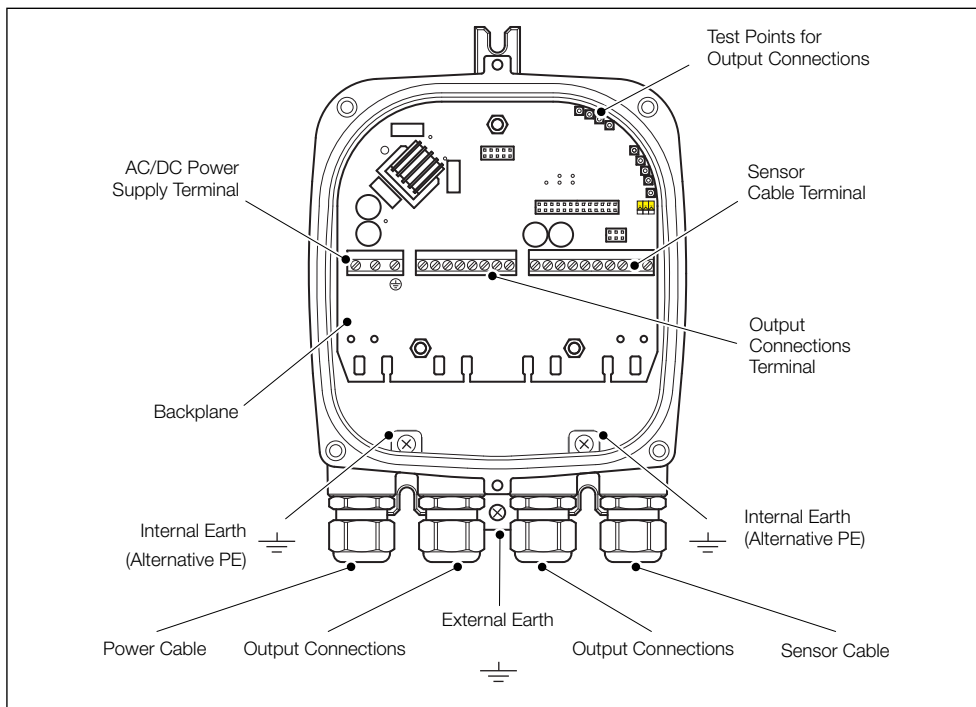



Fig. 3.5 Cable gland / conduit entry (remote transmitter shown)

3.5 Cable preparation (remote systems only)

To prepare the cable for connection at the transmitter and sensor terminal blocks:

1. Remove the outer cable insulation and Mylar® wrap.
2. Ensure the drain wire is sleeved.
3. Cut the cable connection wires to the lengths shown in Fig 3.6, page 15.

3.6 Transmitter / Sensor cable connections

	<p>Caution</p> <ul style="list-style-type: none">■ Make connections only as shown.■ Twist the screen wire of D1 / TFE + D2 with the outer screen drain wire and sleeve them.■ For standard (non-cathodically protected) systems, connect the drain wire to the earth screw.■ For cathodically protected systems, connect the drain wire to terminal SCR, ensuring no braid or wires touch the exposed copper areas within the transmitter sensor cable wiring area.■ If an earth screw is not available at the transmitter enclosure, connect the drain wire to terminal SCR.■ Ensure the seal and mating surfaces are clean to maintain environmental rating.■ Conduit connections must provide cable entry sealing.■ Ensure cable glands are tightened after wiring. Do not overtighten the plastic cable glands to avoid destroying their sealing properties. Initially, tighten finger-tight, then a further 1/2 to 3/4 turn using a suitable spanner or wrench.■ Fit blanking plugs where required.
---	---

3.6.1 Sensor cable terminal connections and recommended cable lengths

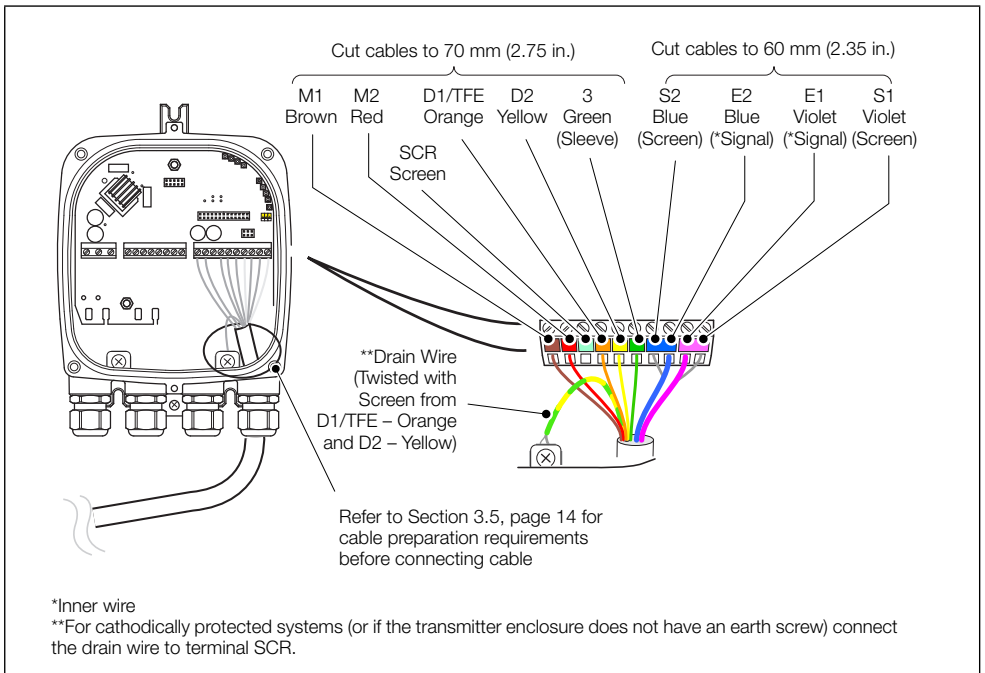

Fig. 3.6 Sensor cable connections at transmitter terminal block – standard system

3.7 Cable rating



The Ex assessment of temperature rise of the enclosure requires that all cabling to the transmitter is rated for at least 100 °C (212 °F).

3.8 Input / Output connections

Refer to WaterMaster User Guide (OI/FET100-EN).

Ensure all cables are rated for ≥ 100 °C (212 °F).

3.9 Power supply connections

The mains voltage and power consumption are indicated on the model plate for the sensor. The wire cross-section for the supply power must meet the requirements for the main fuse (VDE 0100).

The supply power is connected to terminal L (phase), N (neutral) and PE. The supply power connecting cable must be rated for the current consumption of the flowmeter system. The cables must comply with IEC 227 or IEC 245. Connect a switch or a line switch in the supply power feed to the transmitter. This switch should be located near the transmitter and marked as being associated with the device. Connect the transmitter and flowmeter with a functional ground.

**Important**

Observe the limit values for the supply power provided on the nameplate.



- Electrical installation and earthing (grounding) must be in accordance with relevant national and local standards.
- Power must be connected via a suitable isolator and fused in accordance with relevant standards.
- When changing fuses F1 or F2, isolate the power supply and wait 5 minutes before opening the enclosure.
- Replace fuses with the correct part – see Fig 3.7, page 17 (AC power) and Fig. 3.8, page 18 (DC power).

WaterMaster FET100

Electromagnetic flowmeter / transmitter | Hazardous areas ATEX/UKEX/IECEX, Zones 2, 21 and 22

3.9.1 AC power supply

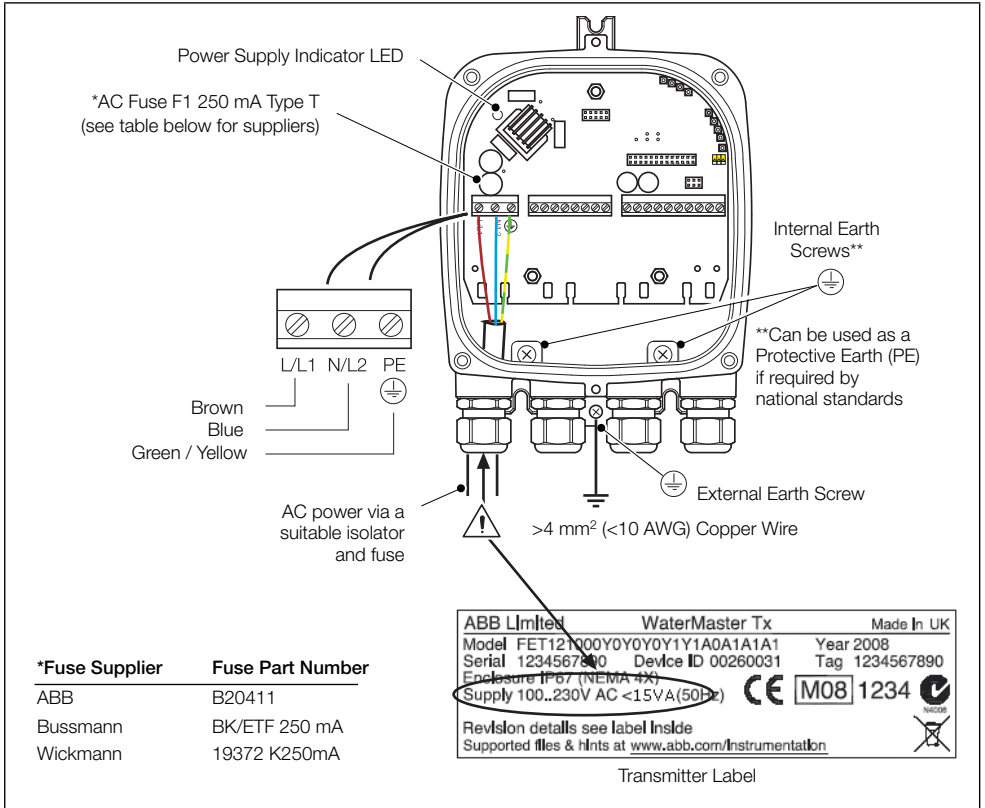

Fig. 3.7 AC power supply connections

WaterMaster FET100

Electromagnetic flowmeter / transmitter | Hazardous areas ATEX/UKEX/IECEx, Zones 2, 21 and 22

3.9.2 DC (and low voltage AC) power supply

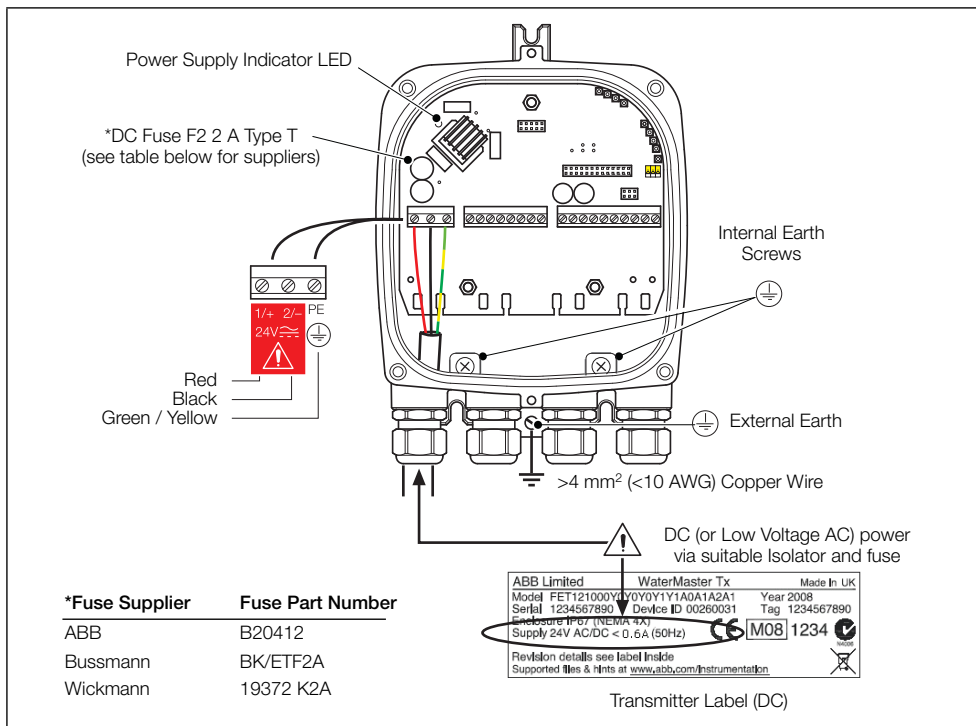

Fig. 3.8 DC (and low voltage AC) power supply connections

3.10 Refitting the cartridge and cover

Referring to Fig. 3.9:

1. Confirm that the cartridge to be fitted is of the correct power supply and for the correct communications bus type (HART, PROFIBUS OR MODBUS) by checking the label (A) on the side of the cartridge:
 - AC cartridges have one **black** label on the cartridge side.
 - DC (and low voltage AC) cartridges have two **red** DC labels – one on the cartridge side and one on the cartridge rear plate.
2. Align the three cartridge screws (B) with the cartridge housing pillars and tighten the screws carefully until the cartridge is held in position.
3. If necessary, rotate the cartridge to the required orientation before refitting the cover – see Fig. 3.4, page 13 for details.
4. For high integrity / security installations, set DIP switch SW1 to the 'ON' (Read-only) position – see WaterMaster User Guide (OI/FET100-EN).
5. Align the transmitter cover with the housing and tighten the four cover screws (C) carefully.
6. For high integrity / security installations or where MID is required, fit anti-tamper seals to the security fixtures D.

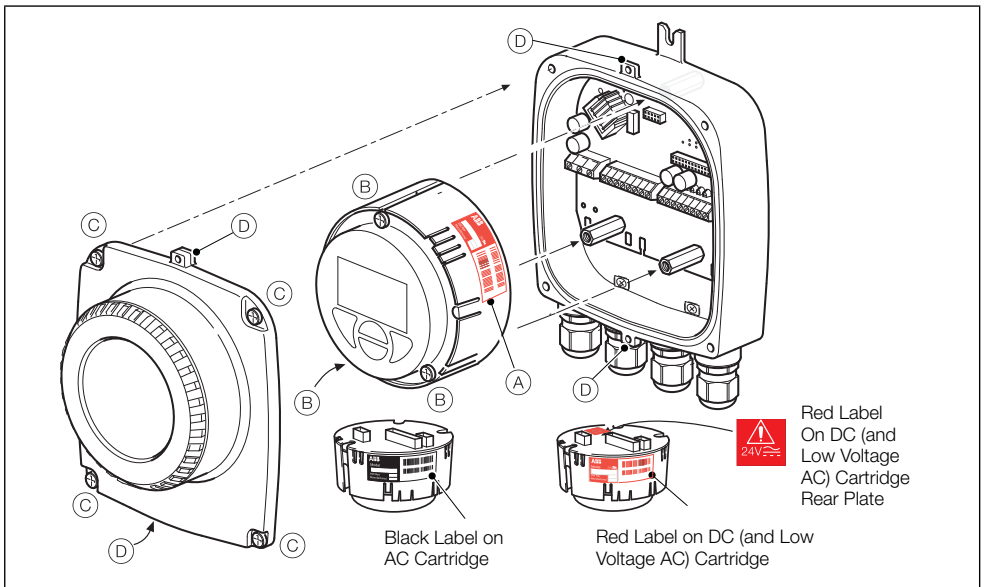



Fig. 3.9 Refitting the cartridge and cover

	<p>Caution – cable glands and stopping plugs</p> <ul style="list-style-type: none"> ■ When not all cable entries are used the installed cable glands have to removed and displaced with a stopping plug delivered and placed in a plastic bag inside the connecting compartment of the housings. Ensure the stopping plugs and O-rings are seated properly and tighten when used. ■ In any other case (for example, by having NPT 1/2 in. threads) take care to tighten correctly.
---	---

4 Ratings

4.1 Electrical data

When operating in potentially explosive areas, observe the following electrical data for the signal inputs and outputs of the transmitter.

	Ex data		Operating values	
	Ex n/NI			
Signal inputs and outputs	U _i [V]	I _i [mA]	U _i [V]	I _i [mA]
Current output Active Terminal 31/32	30	30	30	30
Digital output DO1 Passive Terminal 51/52	30	220	30	220
Digital output DO2 Passive Terminal 41/42	30	220	30	220
Alarm output Passive Terminal 61/62	30	220	30	220

Table 4.1 Electrical data

4.2 Temperature values

Model name	Surface temperature
Sensor	T5 100 °C (212 °F)
Transmitter	T5 100 °C (212 °F)

Table 4.2 Temperature values

5 Commissioning

Refer to WaterMaster User Guides OI/FET100-EN (transmitter) and OI/FEF/FEV/FEW-EN (sensor).

5.1 Preliminary checks prior to start-up

The following points must be checked before commissioning:

- The supply power must be switched off.
- The supply power must match information on the nameplate.
- Wiring must be correct.
- The transmitter must be grounded properly.
- The temperature limits must be observed.
- The sensor must be installed at a largely vibration-free location.
- The housing cover and the cover safety device must be sealed before switching on the supply power.
- Any unused connections must be sealed in accordance with IEC 60079 prior to commissioning using the plugs supplied.

i**Important**

Commissioning and operation must be performed in accordance with ATEX 137 (EN60079-14). Only properly trained personnel are authorized to carry out commissioning in Ex areas.

6 Maintenance

6.1 General information

Repair and maintenance activities may only be performed by authorized customer service personnel. When replacing or repairing individual components, original spare parts must be used.



6.2 Flowmeter sensor – remote sensor

Replace the flowmeter sensor as follows:

- Switch off the transmitter power supply and wait at least 5 minutes before the next step.
- Open the terminal box cover.
- Disconnect the signal cable (if necessary remove the sealing compound).
- Install the new sensor according to the installation instructions.



6.3 Flowmeter transmitter – cartridge

1. Switch off the power supply and wait at least 5 minutes before the next step.

	Warning – serious damage to health / risk to life
	Isolate the transmitter from power supplies before removing the cover.

Referring to Fig. 6.1:

2. Slacken (but do not remove) the four transmitter cover screws (A).
3. Remove the transmitter cover.
4. Check that the power indicator LED (B) on the backplane is **not** lit.

	Warning – serious damage to health / risk to life
	If the power indicator LED (B) is lit, the transmitter is still powered up. Before continuing, isolate the transmitter power supply.

5. If screws (C) are not visible, access them by gently pulling the rotation lock (D) back and rotating the cartridge (E) until the cartridge screw access holes align with the cartridge screw heads.
6. Slacken the three cartridge screws and lift the cartridge (F) away from the housing.

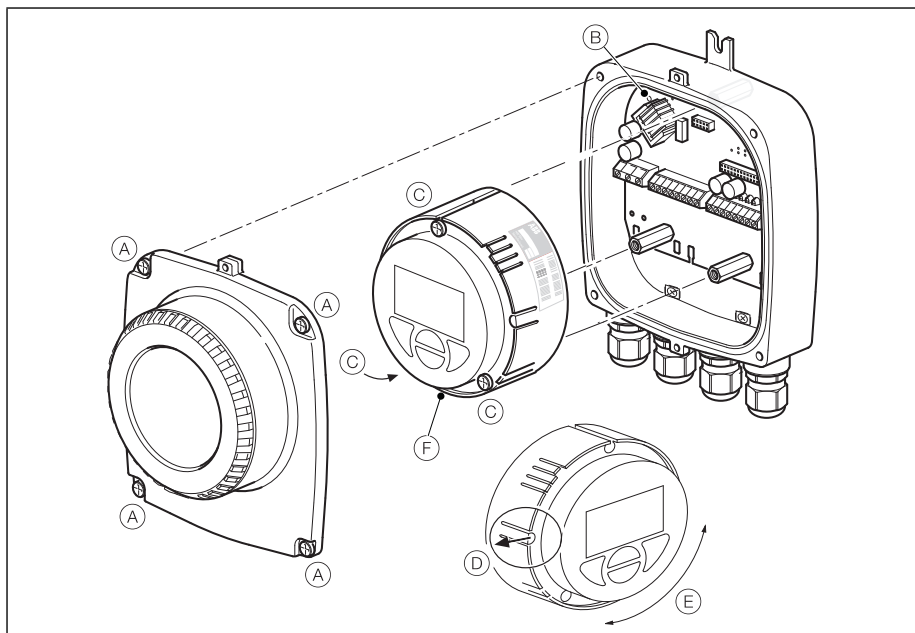

Fig. 6.1 Accessing the Transmitter Terminals

6.3.1 Cartridge replacement

Fit a replacement cartridge if necessary. Ensure it is the correct type, for example, HART, PROFIBUS, DC or AC.

6.3.2 Fuse replacement

For ATEX/UKEX/IECEX transmitters, the Ex approval requires that AC and DC fuses are soldered onto the PCB. to replace a blown fuse,

Referring to Fig. 6.2:

1. Remove the backplane PCB by unscrewing the 3 fixing pillars (A).

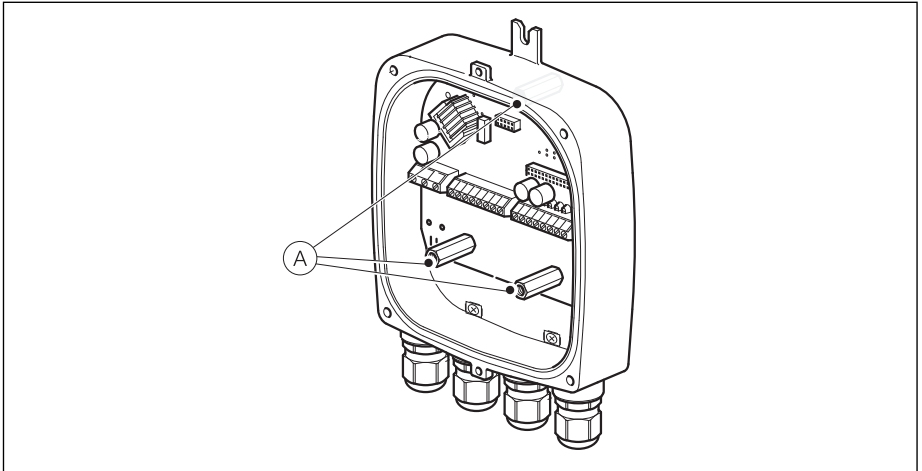



Fig. 6.2 Accessing the Transmitter Terminals

2. Carefully remove the blown fuse taking care not to damage the PCB tracks.

	The replacement fuse must be of the correct type, supplier and part number as specified in Section 3.9.1, page 17 (AC fuse) or Section 3.9.2, page 18 (DC fuse). No other types are permitted.
	Bend the leads to the required pitch and solder into place in the same position as the original.

6.3.3 Refitting the cartridge and cover

Refer to Section 3.10, page 19.

Appendix A – Approvals and certifications

i	<p>Important</p> <p>All documentation, declarations of conformity, and certificates are available in ABB's download area. www.abb.com/flow</p>
----------	--

A.1 Approvals







CE Mark		<p>The version of the meter in your possession meets the requirements of the following European directives:</p> <ul style="list-style-type: none"> ■ Measuring Instruments Directive (MID) 2014/32/EU ■ Low Voltage Directive (LVD) 2014/35/EU ■ Explosive Atmospheres (ATEX) 2014/34/EU ■ Electromagnetic Compatibility Directive (EMC) 2014/30/EU ■ Restriction of the Use of Certain Hazardous Substances (RoHS) 2011/65/EU
UKCA Mark		<p>The version of the meter in your possession meets the requirements of the following UKCA regulations</p> <ul style="list-style-type: none"> ■ Equipment and Protective Systems Intended for Use in Potentially Explosive Atmospheres regulations 2016 - UK SI 2016 Nos.1107 ■ The Electrical Equipment Safety Regulations 2016- UK SI 2016 Nos.1101 ■ The Measuring Equipment Regulations 2016 Nos.1153 ■ Electromagnetic Compatibility Regulations 2016 - UK SI No1091 ■ Restriction of the use of Certain Hazardous Substances in Electrical and Electronic Equipment Regulations 2012 - UK SI 2012 Nos.3032
Explosion Protection	   	<p>Identification for intended use in potentially explosive atmospheres according to:</p> <ul style="list-style-type: none"> ■ ATEX directive (marking in addition to CE marking) ■ IEC standards ■ FM Approvals (US) ■ cFM Approvals (Canada)

Table A.1 Approvals and certifications – CE Mark and Explosion Protection

A.2 Certifications

Certificate description	Certificate number	Notes
Type Examination Certificate	FM10ATEX0036X (page 1 of 4) FM10ATEX0036X (page 2 of 4) FM10ATEX0036X (page 3 of 4) FM10ATEX0036X (page 4 of 4)	See Fig. A.1, page 26 See Fig. A.2, page 27 See Fig. A.3, page 28 See Fig. A.4, page 29
EC-Type Examination Certificate	FM10ATEX0037X (page 1 of 5) FM10ATEX0037X (page 2 of 5) FM10ATEX0037X (page 3 of 5) FM10ATEX0037X (page 4 of 5) FM10ATEX0037X (page 5 of 5)	See Fig. A.5, page 30 See Fig. A.6, page 31 See Fig. A.7, page 32 See Fig. A.8, page 33 See Fig. A.9, page 34
IEC Certificate of Conformity*	IECEX FME10.0006X (page 1 of 3) IECEX FME10.0006X (page 2 of 3) IECEX FME10.0006X (page 3 of 3)	See Fig. A.10, page 35 See Fig. A.11, page 36 See Fig. A.12, page 37
EC Declaration of Conformity	QSTA 1528, Issue 1 (page 1 of 1) QSTA 1528, Issue 1 (page 1 of 2)	See Fig. A.13, page 38 See Fig. A.14, page 39

Table A.2 Schedule of certificates

*The latest IEC Certificate of Conformity can be downloaded from the following website: www.iecex.com

1 TYPE EXAMINATION CERTIFICATE



- 2 **Equipment or Protective systems intended for use in Potentially Explosive Atmospheres - Directive 2014/34/EU**
- 3 **Type Examination Certificate No:** FM10ATEX0036X
- 4 **Equipment or protective system:** WaterMaster FEV, FEW, FEF and FET Electromagnetic Flowmeters
(Type Reference and Name)
- 5 **Name of Applicant:** ABB Ltd
- 6 **Address of Applicant:** Oldends Lane
Stonehouse, Gloucestershire, GL10 3TA
United Kingdom
- 7 This equipment or protective system and any acceptable variation thereto is specified in the schedule to this certificate and documents therein referred to.
- 8 FM Approvals Europe Ltd. certifies that this equipment has been found to comply with the Essential Health and Safety Requirements relating to the design and construction of equipment intended for use in potentially explosive atmospheres given in Annex II to the Directive.
- The examination and test results are recorded in confidential report number:
3040495 dated 01st October 2012
- 9 Compliance with the Essential Health and Safety Requirements, with the exception of those identified in item 15 of the schedule to this certificate, has been assessed by compliance with the following documents:
EN 60079-0:2012+A11:2013 and EN 60079-15:2010
- 10 If the sign 'X' is placed after the certificate number, it indicates that the equipment is subject to specific conditions of use specified in the schedule to this certificate.
- 11 This Type Examination certificate relates only to the design, examination and tests of the specified equipment or protective system in accordance to the Directive 2014/34/EU. Further requirements of the Directive apply to the manufacturing process and supply of this equipment or protective system. These are not covered by this certificate.
- 12 The marking of the equipment or protective system shall include:
-  II 3 G Ex nA IIC T5 Gc Ta= -20 to +60 °C – Remote Transmitter and Integral Transmitter/Sensor
II 3 G Ex nA IIC T5 Gc Ta= -20 to +70 °C – Remote Sensor

Damien Mc Ardle

Damien Mc Ardle
Certification Manager, FM Approvals Europe Ltd.

Issue date: 26th June 2020

THIS CERTIFICATE MAY ONLY BE REPRODUCED IN ITS ENTIRETY AND WITHOUT CHANGE

FM Approvals Europe Ltd. One Georges Quay Plaza, Dublin, Ireland. D02 E440
T: +353 (0) 1761 4200 E-mail: atex@fmaprovals.com www.fmaprovals.com

F ATEX 029 (Mar/2019)

Page 1 of 4

Fig. A.1 Type Examination Certificate No: FM10ATEX0036X (page 1 of 4)

SCHEDULE

to Type Examination Certificate No. FM10ATEX0036X

13 Description of Equipment or Protective System:

The WaterMaster is an electromagnetic flowmeter that is supplied in two main forms: an integral transmitter and sensor version and a remote version which has a separate sensor assembly and transmitter. The transmitter is available with three different input voltage ranges;

85 to 265 V AC at <7 VA;
Low Voltage version: 24 V AC +10%/-30% @ <7 VA /24 V ± 30% @<0.4 A

Three different input and output configuration options available, HART, ModBus and Profibus.

FET1a51m0M1qrst WaterMaster Transmitter Only

a = Housing type: 1 or 2
m = Nameplate: Single digit (Not important for safety)
q = Cable Conduits : A, B, D or F
r = Power supply: 1, 2, 3, or 4
s = Input and Output Signal Type: A, G, or M
t = Configuration Type/Diagnostics Type: Single number (Not important for safety)

FEV1a5cVefghijk1mnMpqrst WaterMaster Series V Flowmeter

a = Housing type: 1, 2, 8, or 9
c = Bore Diameter: 040, 050, 065, 080, 100, 125, 150, 200, 250 or 300
e = Electrode design: 1 or 2
f = Electrode material: C, D, E, S, or U
g = Grounding accessories: 0, 1, 3, 4, 5 or 6
h = Process connection type: A1, E0, E1, E2, E3, E4, E5, E6, S2, S3, S4, J0, or J1
i = Process connection material: B or Z
j = Usage certifications: Single number (Not important for safety)
k = Calibration type: Single digit (Not important for safety)
m = Nameplate: Single digit (Not important for safety)
n = Cable length: Single digit (Not important for safety)
p = Protection Class: 1, 2, or 3
q = Cable Conduits: A, B, D or F
r = Power supply: 0, 1, 2, 3, or 4
s = Input and Output Signal Type: A, G, or M
t = Configuration Type/Diagnostics Type: Single number (Not important for safety)

FEWab5defghijkl1noMqBrStu WaterMaster Series ProcessMaster Sensor

a = Options: 1 or 3
b = Housing type: 1, 2 or 8
d = Bore Diameter: 003, 004, 006, 008, 010, 015, 020, 025, 032, 040, 050, 065, 080, 100, 125, 150, 200, 250, 300, 350, 400, 450, 500, 600, 700, 750, 760, 800, 900, 001, 051, 101, 201, 351, 401, 501, 601, 651, 801, 951, 002, 202, 402, 375, 550, 650, or 402.
e = Liner material: A, E, F, H, J, K, L, M, P, S, or U
f = Electrode design: 1, 2, 5 or 6
g = Electrode material: A, C, D, E, F, G, H, J, K, N, S, T, or W
h = Grounding accessories: 0, 1, 3, 4, 5, or 6
i = Process connection type: A1, A3, A6, A7, A8, A9, B1, B3, C1, C2, C3, C4, D0, D1, D2, D3, D4, D5, D6, E0, E1, E2, E3, E4, E5, E6, E7, E8, J0, J1, J2, J3, S0, S1, S2, S3, or S4
j = Process connection material: B, D, or S
k = Usage certifications: Single number (Not important for safety)
l = Calibration type: Single digit (Not important for safety)

THIS CERTIFICATE MAY ONLY BE REPRODUCED IN ITS ENTIRETY AND WITHOUT CHANGE

FM Approvals Europe Ltd. One Georges Quay Plaza, Dublin, Ireland. D02 E440
T: +353 (0) 1761 4200 E-mail: atex@fmapprovals.com www.fmapprovals.com

F ATEX 029 (Mar/2019)

Page 2 of 4

Fig. A.2 Type Examination Certificate No: FM10ATEX0036X (page 2 of 4)

SCHEDULE

to Type Examination Certificate No. FM10ATEX0036X

n = Nameplate: Single digit (Not important for safety)
 o = Cable length: Single digit (Not important for safety)
 p = Protection Class: 1, 2, 3, or 7
 q = Cable Conduits: A, B, D, or F
 r = Power supply: 0, 1, 2, 3, or 4
 t = Input and Output Signal Type: A, G, or M
 u = Configuration Type/Diagnostics Type: Single number (Not important for safety)

FEF1a5cdefghijk1mnmpqrSt WaterMaster Series F Flowmeter

a = Housing type: 1, 2, 8, or 9
 c = Bore Diameter: 600, 700, 760, 800, 900, 001, 051, 101, 201, 401, 501, 601, 801, 002, 202, 402, or 999
 d = Liner material: B, C, J, K, L, M, U, or Z
 e = Electrode design: 1 or 2
 f = Electrode material: C, D, E, S, or U
 g = Grounding accessories: 0, 1, 3, 4, 5, 6, or 9
 h = Process connection type: A1, A3, C1, C2, E0, E1, E2, E3, E4, E5, E6, E7, E8, J0, J1, J2, S0, S1, S2, S3, S4, or Z9
 i = Process connection material: B or Z
 j = Usage certifications: Single number (Not important for safety)
 k = Calibration type: Single digit (Not important for safety)
 m = Nameplate: Single digit (Not important for safety)
 n = Cable length: Single digit (Not important for safety)
 p = Protection Class: 1, 2, or 3
 q = Cable Conduits: A, B, D, or F
 r = Power supply: 0, 1, 2, 3, or 4
 s = Input and Output Signal Type: A, G, or M
 t = Configuration Type/Diagnostics Type: Single number (Not important for safety)

14 Specific Conditions of Use:

1. Suitable precautions to prevent mechanical damage to the remote terminal housing shall be taken if the enclosure is to be installed in an area of high mechanical danger.
2. The non-metallic material of the remote terminal housing may store electrostatic charge and become a source of ignition in applications with a low relative humidity <~30% relative humidity where the surface is relatively free of surface contamination such as dirt, dust, or oil. Guidance on protection against the risk of ignition due to electrostatic discharge can be found in EN TR50404 and IEC TR60079-32 (in preparation). Cleaning of the surface should only be done with a damp cloth.
3. The temperature at the entry point of the transmitter and remote sensor under rated conditions is higher than 70 °C. Cables rated for 100 °C should be used.

15 Essential Health and Safety Requirements:

The relevant EHSRs that have not been addressed by the standards listed in this certificate have been identified and assessed in the confidential report identified in item 8.

16 Test and Assessment Procedure and Conditions:

This Type Examination Certificate is the result of testing of a sample of the product submitted, in accordance with the provisions of the relevant specific standard(s), and assessment of supporting **THIS CERTIFICATE MAY ONLY BE REPRODUCED IN ITS ENTIRETY AND WITHOUT CHANGE**

FM Approvals Europe Ltd. One Georges Quay Plaza, Dublin, Ireland. D02 E440
 T: +353 (0) 1761 4200 E-mail: atex@fmapprovals.com www.fmapprovals.com

F ATEX 029 (Mar/2019)

Page 3 of 4

Fig. A.3 Type Examination Certificate No: FM10ATEX0036X (page 3 of 4)

SCHEDULE



to Type Examination Certificate No. FM10ATEX0036X

documentation. It does not imply an assessment of the whole production.

Whilst this certificate may be used in support of a manufacturer's claim for CE Marking, FM Approvals Europe Ltd accepts no responsibility for the compliance of the equipment against all applicable Directives in all applications.

This Certificate has been issued in accordance with FM Approvals Europe Ltd's ATEX Certification Scheme.

17 Schedule Drawings

A list of the significant parts of the technical documentation is annexed to this certificate and a copy has been kept by FM Approvals Europe Ltd.

18 Certificate History

Details of the supplements to this certificate are described below:

Date	Description
1 st October 2012	Original Issue.
08 th November 2012 to 23 rd September 2014	<u>Supplements 1 to 6:</u> For details refer to supplement 7 dated 23 rd September 2014.
23 rd September 2014	<u>Supplement 7:</u> Report Reference: 3040495rev140807 dated 11 th September 2014. Description of the Change: General drawing updates.
19 th February 2015	<u>Supplement 8:</u> Report Reference: 3040495rev141120 dated 16 th February 2015. Description of the Change: Additional Bore Diameters added. General drawing updates.
13 th April 2015	<u>Supplement 9:</u> Report Reference: RR200057 dated 10 th April 2015. Description of the Change: Minor change to Plastic Terminal Box and related document updates not affecting compliance.
23 rd November 2016	<u>Supplement 10:</u> Report Reference: RR206687 dated 18 th November 2016. Description of the Change: Minor change to Plastic Terminal Box drawing; correct typo on Type 4 Remote base drawings; reviewed alternative material for VKJ cartridge; additional address information was added to product label; other miscellaneous changes and updated standards.
04 th April 2019	<u>Supplement 11:</u> Description of the Change: Certificate transferred from FM Approvals Ltd., notified body no. 1725, to FM Approvals Europe Ltd., notified body no. 2809.
14 th January 2020	<u>Supplement 12:</u> Report Reference: RR220735 dated 23 rd December 2019. Description of the Change: Change to encapsulant used.
26 th June 2020	<u>Supplement 13:</u> Report Reference: RR222912 dated 23 rd June 2020 Description of the Change: Minor documentation changes.

THIS CERTIFICATE MAY ONLY BE REPRODUCED IN ITS ENTIRETY AND WITHOUT CHANGE

FM Approvals Europe Ltd. One Georges Quay Plaza, Dublin, Ireland. D02 E440
T: +353 (0) 1761 4200 E-mail: atex@fmapprovals.com www.fmapprovals.com

F ATEX 029 (Mar/2019)

Page 4 of 4

Fig. A.4 Type Examination Certificate No: FM10ATEX0036X (page 4 of 4)

1 EU-TYPE EXAMINATION CERTIFICATE



- 2 **Equipment or Protective systems intended for use in Potentially Explosive Atmospheres - Directive 2014/34/EU**
- 3 **EU-Type Examination Certificate No:** FM10ATEX0037X
- 4 **Equipment or protective system:** WaterMaster FEV, FEW, FEF and FET Electromagnetic Flowmeters
(Type Reference and Name)
- 5 **Name of Applicant:** ABB Ltd
- 6 **Address of Applicant:** Oldends Lane
Stonehouse, Gloucestershire, GL10 3TA
United Kingdom
- 7 This equipment or protective system and any acceptable variation thereto is specified in the schedule to this certificate and documents therein referred to.
- 8 FM Approvals Europe Ltd, notified body number 2809 in accordance with Article 17 of Directive 2014/34/EU of 26th February 2014, certifies that this equipment has been found to comply with the Essential Health and Safety Requirements relating to the design and construction of equipment intended for use in potentially explosive atmospheres given in Annex II to the Directive.
- The examination and test results are recorded in confidential report number:
3040495 dated 01st October 2012
- 9 Compliance with the Essential Health and Safety Requirements, with the exception of those identified in item 15 of the schedule to this certificate, has been assessed by compliance with the following documents:
EN 60079-0:2012+A11:2013 and EN 60079-31:2014
- 10 If the sign 'X' is placed after the certificate number, it indicates that the equipment is subject to specific conditions of use specified in the schedule to this certificate.
- 11 This EU-Type Examination certificate relates only to the design, examination and tests of the specified equipment or protective system in accordance to the directive 2014/34/EU. Further requirements of the Directive apply to the manufacturing process and supply of this equipment or protective system. These are not covered by this certificate.
- 12 The marking of the equipment or protective system shall include:
-  II 2 D Ex tb IIIC T100°C Db Ta= -20 to +60 °C – Remote Transmitter and Integral Transmitter/Sensor
II 2 D Ex tb IIIC T100°C Db Ta= -20 to +70 °C – Remote Sensor

Damien McArdle

Damien McArdle
Certification Manager, FM Approvals Europe Ltd.

Issue date: 26th June 2020

THIS CERTIFICATE MAY ONLY BE REPRODUCED IN ITS ENTIRETY AND WITHOUT CHANGE

FM Approvals Europe Ltd. One Georges Quay Plaza, Dublin, Ireland. D02 E440
T: +353 (0) 1761 4200 E-mail: atex@fmapprovals.com www.fmapprovals.com

F ATEX 020 (Mar/2019)

Page 1 of 5

Fig. A.5 EC-Type Examination Certificate No: FM10ATEX0037X (page 1 of 5)

SCHEDULE

to EU-Type Examination Certificate No. FM10ATEX0037X

13 Description of Equipment or Protective System:

The WaterMaster is an electromagnetic flowmeter that is supplied in two main forms: an integral transmitter and sensor version and a remote version which has a separate sensor assembly and transmitter.

The transmitter is available with three different input voltage ranges;

85 to 265 V AC at <7 VA;

Low Voltage version: 24 V AC +10%/-30% @ <7 VA /24 V ± 30% @<0.4 A

Three different input and output configuration options available, HART, ModBus and Profibus.

FET1a51m0M1qrst WaterMaster Transmitter Only

a = Housing type: 1, or 2

m = Nameplate: Single digit (Not important for safety)

q = Cable Conduits : A, B, D or F

r = Power supply: 1, 2, 3, or 4

s = Input and Output Signal Type: A, G, or M

t = Configuration Type/Diagnostics Type: Single number (Not important for safety)

FEV1a5cVefghijk1mnMpqrst WaterMaster Series V Flowmeter

a = Housing type: 1, 2, 8, or 9

c = Bore Diameter: 040, 050, 065, 080, 100, 125, 150, 200, 250 or 300

e = Electrode design: 1 or 2

f = Electrode material: C, D, E, S, or U

g = Grounding accessories: 0, 1, 3, 4, 5 or 6

h = Process connection type: A1, E0, E1, E2, E3, E4, E5, E6, S2, S3, S4, J0, or J1

i = Process connection material: B or Z

j = Usage certifications: Single number (Not important for safety)

k = Calibration type: Single digit (Not important for safety)

m = Nameplate: Single digit (Not important for safety)

n = Cable length: Single digit (Not important for safety)

p = Protection Class: 1, 2, or 3

q = Cable Conduits: A, B, D or F

r = Power supply: 0, 1, 2, 3, or 4

s = Input and Output Signal Type: A, G, or M

t = Configuration Type/Diagnostics Type: Single number (Not important for safety)

FEWab5defghijkl1noMqBrStu WaterMaster Series ProcessMaster Sensor

a = Options: 1 or 3

b = Housing type: 1, 2 or 8

d = Bore Diameter: 003, 004, 006, 008, 010, 015, 020, 025, 032, 040, 050, 065, 080, 100, 125, 150, 200, 250, 300, 350, 400, 450, 500, 600, 700, 750, 760, 800, 900, 001, 051, 101, 201, 351, 401, 501, 601, 651, 801, 951, 002, 202, 102, 375, 550, 650, or 402.

e = Liner material: A, E, F, H, J, K, L, M, P, S, or U

f = Electrode design: 1, 2, 5 or 6

g = Electrode material: A, C, D, E, F, G, H, J, K, N, S, T, or W

h = Grounding accessories: 0, 1, 3, 4, 5, or 6

i = Process connection type: A1, A3, A6, A7, A8, A9, B1, B3, C1, C2, C3, C4, D0, D1, D2, D3, D4, D5, D6, E0, E1, E2, E3, E4, E5, E6, E7, E8, J0, J1, J2, J3, S0, S1, S2, S3, or S4

j = Process connection material: B, D or S

k = Usage certifications: Single number (Not important for safety)

l = Calibration type: Single digit (Not important for safety)

THIS CERTIFICATE MAY ONLY BE REPRODUCED IN ITS ENTIRETY AND WITHOUT CHANGE

FM Approvals Europe Ltd. One Georges Quay Plaza, Dublin, Ireland. D02 E440
T: +353 (0) 1761 4200 E-mail: atex@fmapprovals.com www.fmapprovals.com

F ATEX 020 (Mar/2019)

Page 2 of 5

Fig. A.6 EC-Type Examination Certificate No: FM10ATEX0037X (page 2 of 5)

SCHEDULE

to EU-Type Examination Certificate No. FM10ATEX0037X

n = Nameplate: Single digit (Not important for safety)
 o = Cable length: Single digit (Not important for safety)
 p = Protection Class: 1, 2, 3, or 7
 q = Cable Conduits : A, B, D or F
 r = Power supply: 0, 1, 2, 3, or 4
 t = Input and Output Signal Type: A, G, or M
 u = Configuration Type/Diagnostics Type: Single number (Not important for safety)

FEF1a5cdefghijk1mnMppqrSt WaterMaster Series F Flowmeter

a = Housing type: 1, 2, 8, or 9
 c = Bore Diameter: 600, 700, 760, 800, 900, 001, 051, 101, 201, 401, 501, 601, 801, 002, 202, 402, or 999
 d = Liner material: B, C, J, K, L, M, U, or Z
 e = Electrode design: 1 or 2
 f = Electrode material: C, D, E, S, or U
 g = Grounding accessories: 0, 1, 3, 4, 5, 6, or 9
 h = Process connection type: A1, A3, C1, C2, E0, E1, E2, E3, E4, E5, E6, E7, E8, J0, J1, J2, S0, S1, S2, S3, S4, or Z9
 i = Process connection material: B or Z
 j = Usage certifications: Single number (Not important for safety)
 k = Calibration type: Single digit (Not important for safety)
 m = Nameplate: Single digit (Not important for safety)
 n = Cable length: Single digit (Not important for safety)
 p = Protection Class: 1, 2, or 3
 q = Cable Conduits: A, B, D or F
 r = Power supply: 0, 1, 2, 3, or 4
 s = Input and Output Signal Type: A, G, or M
 t = Configuration Type/Diagnostics Type: Single number (Not important for safety)

14 Specific Conditions of Use:

1. Suitable precautions to prevent mechanical damage to the remote terminal housing shall be taken if the enclosure is to be installed in an area of high mechanical danger.
2. The non-metallic material of the remote terminal housing may store electrostatic charge and become a source of ignition in applications with a low relative humidity <~30% relative humidity where the surface is relatively free of surface contamination such as dirt, dust, or oil. Guidance on protection against the risk of ignition due to electrostatic discharge can be found in EN TR50404 and IEC TR60079-32 (in preparation). Cleaning of the surface should only be done with a damp cloth.
3. The temperature at the entry point of the transmitter and remote sensor under rated conditions is higher than 70 °C. Cables rated for 100°C should be used.

15 Essential Health and Safety Requirements:

The relevant EHSRs that have not been addressed by the standards listed in this certificate have been identified and assessed in the confidential report identified in item 8.

THIS CERTIFICATE MAY ONLY BE REPRODUCED IN ITS ENTIRETY AND WITHOUT CHANGE

FM Approvals Europe Ltd. One Georges Quay Plaza, Dublin, Ireland. D02 E440
 T: +353 (0) 1761 4200 E-mail: atex@fmapprovals.com www.fmapprovals.com

F ATEX 020 (Mar/2019)

Page 3 of 5

Fig. A.7 EC-Type Examination Certificate No: FM10ATEX0037X (page 3 of 5)

SCHEDULE



to EU-Type Examination Certificate No. FM10ATEX0037X

16 Test and Assessment Procedure and Conditions:

This EU-Type Examination Certificate is the result of testing of a sample of the product submitted, in accordance with the provisions of the relevant specific standard(s), and assessment of supporting documentation. It does not imply an assessment of the whole production.

Whilst this certificate may be used in support of a manufacturer's claim for CE Marking, FM Approvals Europe Ltd accepts no responsibility for the compliance of the equipment against all applicable Directives in all applications.

This Certificate has been issued in accordance with FM Approvals Europe Ltd's ATEX Certification Scheme.

17 Schedule Drawings

A list of the significant parts of the technical documentation is annexed to this certificate and a copy has been kept by the Notified Body.

18 Certificate History

Details of the supplements to this certificate are described below:

Date	Description
02 nd October 2012	Original Issue.
08 th November 2012 to 23 rd September 2013	Supplement 1 to 4 See certificate dated 23 rd September 2013.
11 th October 2013	Supplement 5: Report Reference: 3035729rev130607_33593-283 and 3035729rev130607_34290-283 both dated 9 th October 2013. Description of the Change: 1. Update to label drawings 2. Modification to input circuitry.
06 th June 2014	Supplement 6: Report Reference: 3050598 dated 03 rd June 2014. Description of the Change: New Remote Housing and update to Standards to current editions
23 rd September 2014	Supplement 7: Report Reference: 3040495rev140807 dated 11 th September 2014. Description of the Change: 1. General drawing updates 2. Replacement of draft standard prEN 60079-31:2014 with the published version EN 60079-31:2014.
19 th February 2015	Supplement 8: Report Reference: 3040495rev141120 dated 16 th February 2015. Description of the Change: Additional Bore Diameters added. General drawing updates.
13 th April 2015	Supplement 9: Report Reference: RR200057 dated 10 th April 2015. Description of the Change: Minor change to Plastic Terminal Box and related document updates not affecting compliance.

THIS CERTIFICATE MAY ONLY BE REPRODUCED IN ITS ENTIRETY AND WITHOUT CHANGE

FM Approvals Europe Ltd. One Georges Quay Plaza, Dublin, Ireland. D02 E440
T: +353 (0) 1761 4200 E-mail: atex@fmapprovals.com www.fmapprovals.com

F ATEX 020 (Mar/2019)

Page 4 of 5

Fig. A.8 EC-Type Examination Certificate No: FM10ATEX0037X (page 4 of 5)

SCHEDULE



to EU-Type Examination Certificate No. FM10ATEX0037X

Date	Description
23 rd November 2016	Supplement 10: Report Reference: RR206687 dated 18 th November 2016. Description of the Change: Minor change to Plastic Terminal Box drawing; correct typo on Type 4 Remote base drawings; reviewed alternative material for VKJ cartridge; additional address information was added to product label; other miscellaneous changes, updated standards and updated certificate to EU format.
14 th January 2020	Supplement 11: Report Reference: RR220735 dated 23 rd December 2019. Description of the Change: Change to encapsulant used.
26 th June 2020	Supplement 12: Report Reference: RR222912 dated 23 rd June 2020 Description of the Change: Minor documentation changes.



THIS CERTIFICATE MAY ONLY BE REPRODUCED IN ITS ENTIRETY AND WITHOUT CHANGE

FM Approvals Europe Ltd, One Georges Quay Plaza, Dublin, Ireland, D02 E440
 T: +353 (0) 1761 4200 E-mail: atex@fmapprovals.com www.fmapprovals.com

F ATEX 020 (Mar2019)

Page 5 of 5

Fig. A.9 EC-Type Examination Certificate No: FM10ATEX0037X (page 5 of 5)



IECEX Certificate of Conformity

INTERNATIONAL ELECTROTECHNICAL COMMISSION IEC Certification System for Explosive Atmospheres

for rules and details of the IECEx Scheme visit www.iecex.com

Certificate No.:	IECEX FME 10.0006X	Page 1 of 4	<u>Certificate history:</u>
Status:	Current	Issue No: 12	Issue 11 (2020-01-13)
Date of Issue:	2020-06-24		Issue 10 (2016-11-23)
Applicant:	ABB Limited Oldends Lane Stonehouse Gloucestershire GL10 3TA United Kingdom		Issue 9 (2015-04-13)
Equipment:	WaterMaster Electromagnetic Flowmeter		Issue 8 (2015-02-19)
Optional accessory:			Issue 7 (2014-09-23)
Type of Protection:	Protection by Enclosure 't' and Type of Protection 'n'		Issue 6 (2014-06-06)
Marking:	Ex tb III C T100°C Db Ex nA IIC T5 Gc Ta = -20°C to +60°C (Remote Transmitter and Integral Transmitter/Sensor) Ta = -20°C to +70°C (Remote Sensor)		Issue 5 (2013-10-11)
			Issue 4 (2013-09-23)
			Issue 3 (2013-07-09)
			Issue 2 (2013-04-23)

Approved for issue on behalf of the IECEx
Certification Body:

Andrew Was

Position:

Certification Manager

Signature:
(for printed version)

Date:

1. This certificate and schedule may only be reproduced in full.
2. This certificate is not transferable and remains the property of the issuing body.
3. The Status and authenticity of this certificate may be verified by visiting www.iecex.com or use of this QR Code.



Certificate issued by:

FM Approvals Ltd
Voyager Place
Maidenhead
Berkshire
SL6 2PJ
United Kingdom



Member of the FM Global Group

Fig. A.10 IEC Certificate of Conformity No: IECEX FME10.0006X (page 1 of 3)

		<h2 style="margin: 0;">IECEX Certificate of Conformity</h2>															
Certificate No.:	IECEX FME 10.0006X	Page 2 of 4															
Date of issue:	2020-06-24	Issue No: 12															
Manufacturer:	<p>ABB Limited Oldend's Lane Stonehouse Gloucestershire GL5 5DZ United Kingdom</p>																
Additional manufacturing locations:	<p>ABB Engineering (Shanghai) Limited No 4528, KangXin Road KangQiao Town Pudong New District Shanghai. 201319 China</p>																
<p>This certificate is issued as verification that a sample(s), representative of production, was assessed and tested and found to comply with the IEC Standard list below and that the manufacturer's quality system, relating to the Ex products covered by this certificate, was assessed and found to comply with the IECEX Quality system requirements. This certificate is granted subject to the conditions as set out in IECEX Scheme Rules, IECEX 02 and Operational Documents as amended</p>																	
<p>STANDARDS : The equipment and any acceptable variations to it specified in the schedule of this certificate and the identified documents, was found to comply with the following standards</p>																	
IEC 60079-0:2011 Edition:6.0	Explosive atmospheres - Part 0: General requirements																
IEC 60079-15:2010 Edition:4	Explosive atmospheres - Part 15: Equipment protection by type of protection "n"																
IEC 60079-31:2013 Edition:2	Explosive atmospheres - Part 31: Equipment dust ignition protection by enclosure "t"																
<p>This Certificate does not indicate compliance with safety and performance requirements other than those expressly included in the Standards listed above.</p>																	
<p>TEST & ASSESSMENT REPORTS: A sample(s) of the equipment listed has successfully met the examination and test requirements as recorded in:</p>																	
<p>Test Reports:</p> <table border="0" style="width: 100%;"> <tr> <td style="width: 33%;">GB/FME/ExTR11.0005/00</td> <td style="width: 33%;">GB/FME/ExTR11.0005/01</td> <td style="width: 33%;">GB/FME/ExTR11.0005/02</td> </tr> <tr> <td>GB/FME/ExTR11.0005/03</td> <td>GB/FME/ExTR11.0005/04</td> <td>GB/FME/ExTR11.0005/05</td> </tr> <tr> <td>GB/FME/ExTR11.0005/06</td> <td>GB/FME/ExTR11.0005/07</td> <td>GB/FME/ExTR11.0005/08</td> </tr> <tr> <td>GB/FME/ExTR11.0005/09</td> <td>GB/FME/ExTR11.0005/10</td> <td>GB/FME/ExTR11.0005/11</td> </tr> <tr> <td>GB/FME/ExTR11.0005/12</td> <td></td> <td></td> </tr> </table>			GB/FME/ExTR11.0005/00	GB/FME/ExTR11.0005/01	GB/FME/ExTR11.0005/02	GB/FME/ExTR11.0005/03	GB/FME/ExTR11.0005/04	GB/FME/ExTR11.0005/05	GB/FME/ExTR11.0005/06	GB/FME/ExTR11.0005/07	GB/FME/ExTR11.0005/08	GB/FME/ExTR11.0005/09	GB/FME/ExTR11.0005/10	GB/FME/ExTR11.0005/11	GB/FME/ExTR11.0005/12		
GB/FME/ExTR11.0005/00	GB/FME/ExTR11.0005/01	GB/FME/ExTR11.0005/02															
GB/FME/ExTR11.0005/03	GB/FME/ExTR11.0005/04	GB/FME/ExTR11.0005/05															
GB/FME/ExTR11.0005/06	GB/FME/ExTR11.0005/07	GB/FME/ExTR11.0005/08															
GB/FME/ExTR11.0005/09	GB/FME/ExTR11.0005/10	GB/FME/ExTR11.0005/11															
GB/FME/ExTR11.0005/12																	
<p>Quality Assessment Reports:</p> <table border="0" style="width: 100%;"> <tr> <td style="width: 33%;">GB/BAS/QAR08.0001/06</td> <td style="width: 33%;">GB/FME/QAR10.0007/11</td> <td style="width: 33%;"></td> </tr> </table>			GB/BAS/QAR08.0001/06	GB/FME/QAR10.0007/11													
GB/BAS/QAR08.0001/06	GB/FME/QAR10.0007/11																

Fig. A.11 IEC Certificate of Conformity No: IECEX FME10.0006X (page 2 of 3)

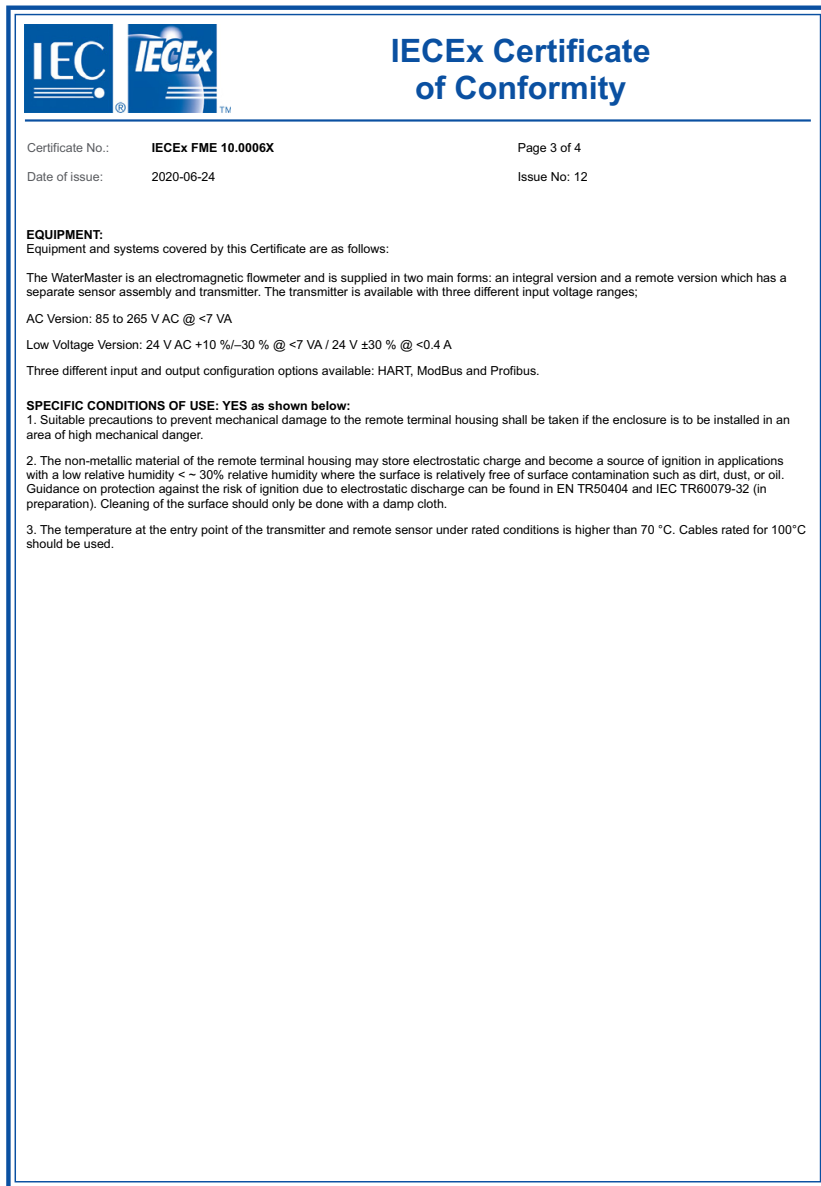

Fig. A.12 IEC Certificate of Conformity No: IECEX FME10.0006X (page 3 of 3)



EU Declaration of Conformity

Manufacturer: ABB Limited

Address: Oldends Lane
Stonehouse
Gloucestershire
England
GL10 3TA

This declaration of conformity is issued under the sole responsibility of the manufacturer for the following product(s)

WaterMaster FET1

Which can be used with the following sensor:

***FEV, FEW, FER & FEF
Size: DN10 – DN2400***



ABB Limited
Oldends Lane, Stonehouse,
GL10 3TA, UK

Page 1 of 2

Fig. A.13 EC Declaration of Conformity (page 1 of 2)



The object of the declaration described above is in conformity with the relevant union harmonised legislation as follows:

- Measuring Instruments Directive (MID) 2014/32/EU**
- Low Voltage Directive (LVD) 2014/35/EU**
- Explosive Atmospheres (ATEX) 2014/34/EU**
- Electromagnetic Compatibility Directive (EMC) 2014/30/EU**
- Restriction of the use of certain hazardous substances (RoHS) 2011/65/EU**

The following harmonised standards and technical specifications have been applied:

Approval Available				
Model Approved	Directive/Regulation	Standard	Test report	Certificate No.
FEV, FEW, FEF & FET	ATEX	EN 60079-0:2012 EN 60079-15:2010 EN 60079-31:2014	3040495	FM10ATEX0036X FM10ATEX0037X
FET	LVD	Class 3810	FM FEVFEF Report 3035729	FM USA 3035729 FM Canada 3035729C
FEV DN40, DN50, DN80, DN100, DN150, DN200, DN250 & DN300	MID	OIML R49-1:2006	D&D ReportWMFEV1	Certificate T11992 Cert R49 2006 GB1- 10.01
FET	EMC	OIML R49-1:2006 Additional Test: EN6100-4-3:2002 EN6100-4-6:1996 EN6100-4-5:1995	TR 0550 - WaterMaster Test report	*NA

* There is no certificate for EMC's standards. The test was done by a third party test house. This declaration covers the compliance to EMC based on the standards the product has been tested and passed to.

Please refer to the above listed certificate for technical data and software version.

**This certificate is only valid when the approved product is installed and operated according to the supplied instructions.

13/04/2021

Date of Issue:

Prepared by:
Davidson Onwughalu
Certification Engineer

**John
Marshall1**

Approved by:
John P. Marshall
LDL Quality Manager

Digitally signed by John Marshall
DN: cn=John Marshall,
ou=ldl
Date: 2021.04.13 15:32:04
+01'00'

Fig. A.14 EC Declaration of Conformity (page 2 of 2)

Notes

Acknowledgments

- Modbus is a registered trademark of Schneider Electric USA Inc.
- HART is a registered trademark of the FieldComm Group.
- PROFIBUS is a registered trademark of PROFIBUS organization.

Sales



Service



ABB Measurement & Analytics

For your local ABB contact, visit:
www.abb.com/contacts

For more product information, visit:
www.abb.com/measurement

We reserve the right to make technical changes or modify the contents of this document without prior notice. With regard to purchase orders, the agreed particulars shall prevail. ABB does not accept any responsibility whatsoever for potential errors or possible lack of information in this document.

We reserve all rights in this document and in the subject matter and illustrations contained therein. Any reproduction, disclosure to third parties or utilization of its contents – in whole or in parts – is forbidden without prior written consent of ABB.