



## For more information

Further publications for the WaterMaster electromagnetic flowmeter are available for free download from:

[www.abb.com/measurement](http://www.abb.com/measurement)

or by scanning this code:



ABB MEASUREMENT & ANALYTICS | PROGRAMMING GUIDE | IM/WMP REV. G

# WaterMaster

## Electromagnetic flowmeter



Measurement made easy

WaterMaster  
flowmeter

Search for or click on

Data Sheet	<a href="#">DS/WM-EN</a>
WaterMaster   Electromagnetic flowmeter	
User Guide	<a href="#">IM/WM</a>
WaterMaster   Electromagnetic flowmeter	
User Guide Supplement – PROFIBUS RS485 Physical Layer (FEX100-DP)	<a href="#">IM/WMPBS-EN</a>
WaterMaster   Electromagnetic flowmeter	
User Guide Supplement – PROFIBUS FEX100-DP Parameter Tables	<a href="#">IM/WMPBST-EN</a>
WaterMaster   Electromagnetic flowmeter	
Setup Guide	<a href="#">IM/WM/VM</a>
VeriMaster   Software tools	

Key: Standard Access Advanced Access

Refer to Instruction Manual IM/WM

Refer to: Section 5.2.1, page 14

Refer to: Section 5.2.2, page 16

Refer to Section 5.2.3, page 20

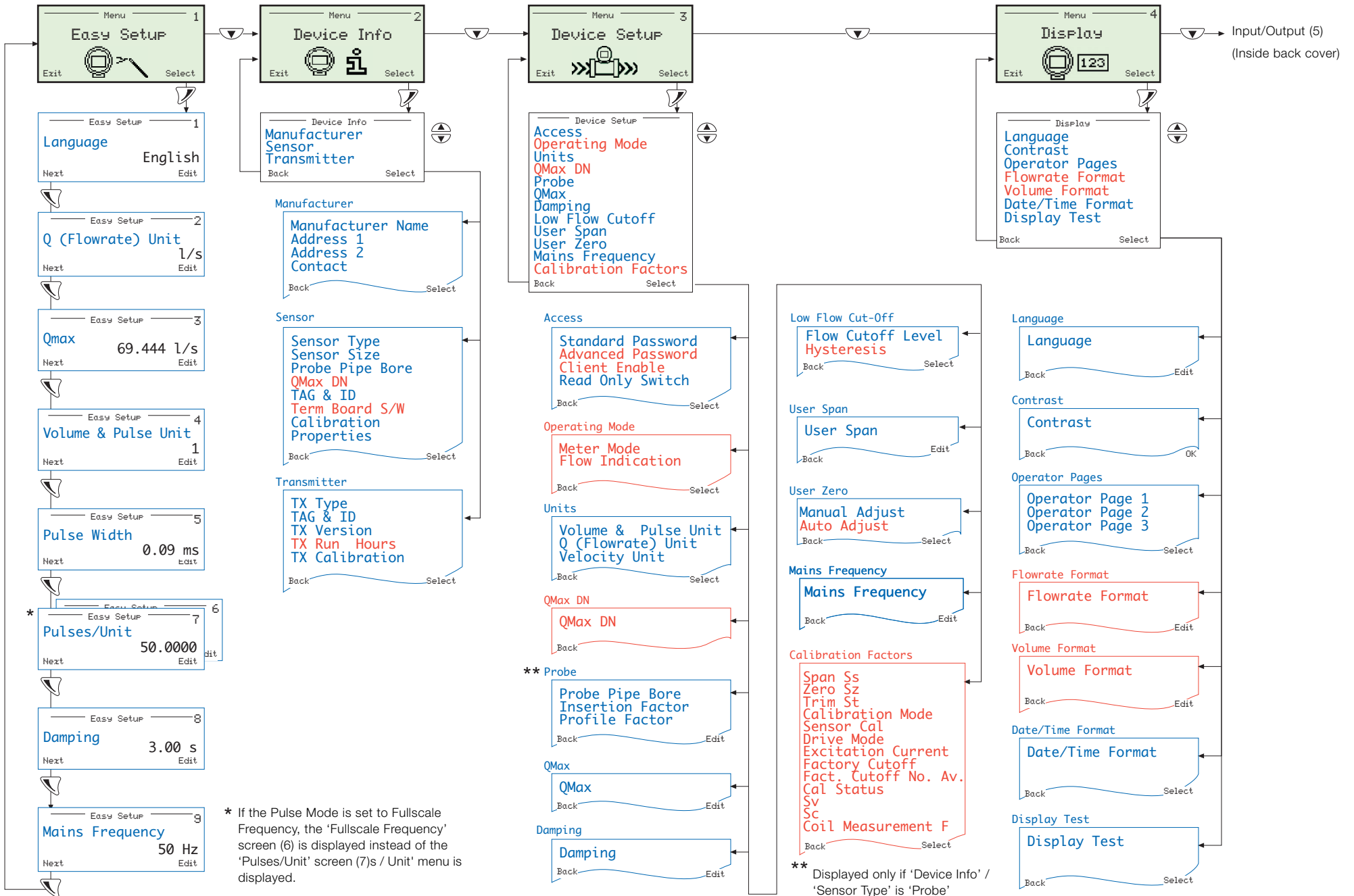

# Contents

- 1 Safety ..... 3**
  - 1.1 Electrical Safety ..... 3
  - 1.2 Symbols ..... 3
  - 1.3 Health & Safety ..... 3
  
- 2 Introduction ..... 4**
  - 2.1 Quality Control ..... 4
  
- 3 Startup Conditions ..... 5**
  - 3.1 Data Types ..... 5
  - 3.2 Memory Configuration ..... 5
  - 3.3 Alternative Startup Screens ..... 6
  
- 4 Passwords and Security Options ..... 8**
  - 4.1 Setting Passwords ..... 8
    - 4.1.1 Default Passwords ..... 8
    - 4.1.2 Changing Passwords ..... 8
  - 4.2 Security/Anti-tamper Sealing ..... 8
  
- 5 Overview of Operator Pages and Menus ..... 9**
  - 5.1 Operator Menus ..... 10
  - 5.2 Menus ..... 12
    - 5.2.1 Device Info ..... 14
    - 5.2.2 Device Setup ..... 16
    - 5.2.3 Display ..... 20
    - 5.2.4 Input/Output ..... 22
    - 5.2.5 Process Alarm ..... 25
    - 5.2.6 Communication ..... 27
    - 5.2.7 Totalizer ..... 29
    - 5.2.8 Diagnostics ..... 30
    - 5.2.9 Service ..... 32
  
- 6 HART®-Protocol ..... 33**
  - 6.1 Overview ..... 33
  - 6.2 Hardware and Software Requirements ..... 33
  - 6.3 HART-Protocol Configuration ..... 34
  - 6.4 HART-Protocol Connection ..... 34
  - 6.5 HART-specific Device Type Manager (DTM FEX100 HART) ..... 35
    - 6.5.1 Supported Devices (DTM FEX100 HART) ..... 35
    - 6.5.2 DTM (Driver) Version Record ..... 36
    - 6.5.3 PC Hardware / Operating System Requirements ..... 36
    - 6.5.4 Obtaining the WaterMaster Device DTM ..... 36
    - 6.5.5 Installing the WaterMaster Device DTM ..... 36
    - 6.5.6 Updating the WaterMaster Device DTM ..... 36
    - 6.5.7 Getting Help and Further Information ..... 36
    - 6.5.8 Uninstalling the WaterMaster DTM ..... 37

<b>7</b>	<b>Troubleshooting .....</b>	<b>38</b>
7.1	Alarms .....	38
7.1.1	Alarm Codes .....	39
<b>8</b>	<b>Remote Computer Connection .....</b>	<b>48</b>
8.1	Utility Software for PC .....	48
8.2	Installing the Utility Software .....	49
8.3	Attaching the Service Port Adaptor to the Transmitter .....	50
8.4	Configuring the Service Port Splitter .....	51
8.4.1	Configuration Overview .....	51
8.4.2	COM Port and Client Configuration .....	52
8.4.3	Stopping the Service .....	55
8.4.4	Starting the Service .....	55
8.5	Cyclic Data Out .....	56
8.6	Parameter Dump .....	57
8.7	Remote HMI .....	58
8.8	HART Client .....	59
	<b>Notes .....</b>	<b>60</b>

# 1 Safety

Information in this manual is intended only to assist our customers in the efficient operation of our equipment. Use of this manual for any other purpose is specifically prohibited and its contents are not to be reproduced in full or part without prior approval of the Technical Publications Department.





## 1.1 Electrical Safety





This equipment complies with the requirements of CEI/IEC 61010-1:2001-2 'Safety Requirements for Electrical Equipment for Measurement, Control and Laboratory Use' and complies with US NEC 500, NIST and OSHA.

If the equipment is used in a manner NOT specified by the Company, the protection provided by the equipment may be impaired.

## 1.2 Symbols

One or more of the following symbols may appear on the equipment labelling:

	<b>Warning</b> – Refer to the manual for instructions
	<b>Caution</b> – Risk of electric shock
	Protective earth (ground) terminal
	Earth (ground) terminal

	Direct current supply only
	Alternating current supply only
	Both direct and alternating current supply
	The equipment is protected through double insulation

## 1.3 Health & Safety

### Health and Safety

To ensure that our products are safe and without risk to health, the following points must be noted:

- The relevant sections of these instructions must be read carefully before proceeding.
- Warning labels on containers and packages must be observed.
- Installation, operation, maintenance and servicing must only be carried out by suitably trained personnel and in accordance with the information given.
- Normal safety precautions must be taken to avoid the possibility of an accident occurring when operating in conditions of high pressure and/or temperature.
- Chemicals must be stored away from heat, protected from temperature extremes and powders kept dry. Normal safe handling procedures must be used.
- When disposing of chemicals ensure that no two chemicals are mixed.

Safety advice concerning the use of the equipment described in this manual or any relevant hazard data sheets (where applicable) may be obtained from the Company address on the back cover, together with servicing and spares information.

## 2 Introduction

WaterMaster™ is a range of high performance electromagnetic flowmeters for the measurement of electrically conductive fluids and systems are normally supplied factory-configured and calibrated.

This Programming Guide provides user details of the WaterMaster transmitter software for 'Read Only', 'Standard' and 'Advanced' level users.

This guide applies to Application Software V01.02.00 onwards. The version number is found at the menu location: 'Device Info / Transmitter / TX Version / Application' – see Section 5.2.1, page 14.

### Warning.

- System configuration must be carried out only by users or personnel with approved access rights (user privileges).
- Read all relevant sections of this guide before configuring the system or modifying system parameters.
- Install and use this equipment as detailed in the Instruction Manual (IM/WM). Install and use associated equipment in accordance with the relevant national and local standards.

This Programming Guide should be used in conjunction with the following publications:

- User Guide – IM/WM
- User Guide Supplement, PROFIBUS RS485 Physical Layer (FEX100-DP) – IM/WMPBS-EN
- User Guide Supplement, PROFIBUS FEX100-DP Parameter Tables – IM/WMPBST-EN

### 2.1 Quality Control

The UKAS Calibration Laboratory No. 0255 is just one of the ten flow calibration plants operated by the Company and is indicative of our dedication to quality and accuracy.

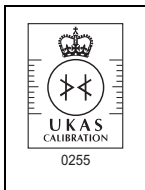

Fig. 2.1 UKAS Calibration Laboratory No. 0255

### 3 Startup Conditions

As part of the startup procedure, an automatic data integrity check is run to compare and verify data stored in the transmitter memory with data stored in the sensor memory – see Fig. 3.1.

If both sets of data match, normal operating conditions are assumed and the 'Operator Menu' is displayed – see Section 5, page 9.

If there is a data mismatch, alternative user screens are displayed according to the startup condition detected. These screens enable data and equipment to be synchronized as detailed in Section 3.3, page 6.

#### 3.1 Data Types

Data for the system is sub-divided into three main types:

- Sensor data – comprising sensor-specific information such as: calibration factors, sensor tag and sensor serial number. Sensor data is stored in transmitter and sensor memories.
- Plant data – plant-specific information such as: flowrate, volume units and pulse/unit range. Plant data is stored in both the transmitter and sensor memories.
- Transmitter data – transmitter-specific information such as: current calibration factors, transmitter tag and transmitter serial number. Transmitter data is stored only in the transmitter memory.

#### 3.2 Memory Configuration

Memory is allocated according to the type of system as follows:

- Remote systems have the transmitter memory fitted at the transmitter and the sensor memory fitted at the sensor.
- Integral systems and systems with remote transmitters connected to retrofit sensors have the transmitter memory and the sensor memory fitted at the transmitter (the sensor memory is mounted on the transmitter backplane).

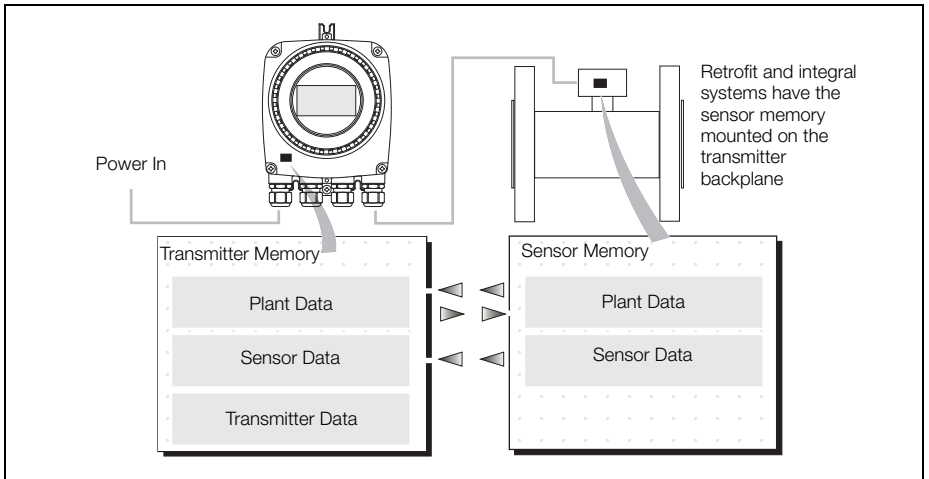
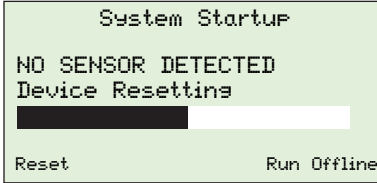

Fig. 3.1 Memory Location on Remote System

### 3.3 Alternative Startup Screens

**Note.** If a data mismatch is detected during startup (normal operating conditions are not detected) the following startup screens are displayed.



#### No Sensor Detected

If no sensor is detected during start-up, an auto-recovery routine is run to look for the sensor. If no sensor is detected, this routine continues until it is stopped manually.

If 'Run Offline' is selected during auto-recovery (by pressing the  key) the transmitter ceases to operate as a flowmeter and the following conditions apply at the transmitter:

- Plant and transmitter data can be configured (independently of the sensor location).
- Sensor data cannot be configured.

**Note.** If this screen is displayed on an integral transmitter, check that DIP switch SW3 is in the 'ON' position (refer to Fig. 3.2 for switch positions).

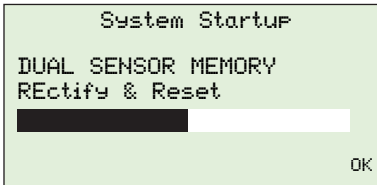

#### Dual Sensor Memory

Integral and retrofit systems have the sensor memory mounted on the transmitter backplane board.

If two sensor types (integral and remote) are detected at startup a warning 'DUAL SENSOR MEMORY' is displayed.

To correct this condition, set DIP switch SW3 on the transmitter backplane to the 'OFF' position (refer to Fig. 3.2 for switch positions).

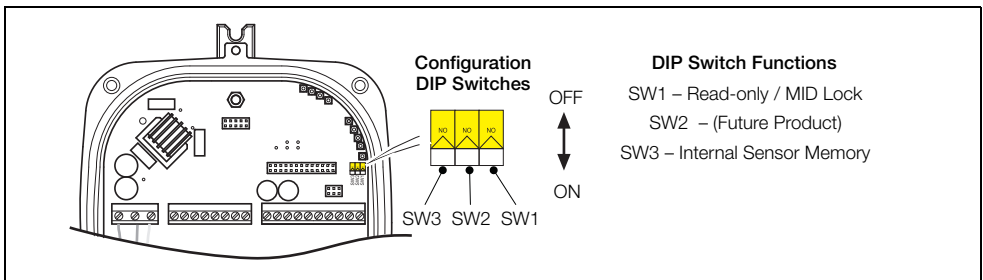
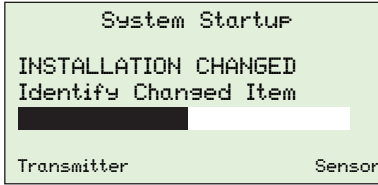

Fig. 3.2 Configuration DIP Switches





### Installation Changed

If the sensor data stored in the transmitter memory does not match the sensor ID and data of the connected sensor, the warning 'INSTALLATION CHANGED' is displayed.

This screen enables connection of:

- a new or replacement transmitter to an existing sensor
- replacement sensor electronics to an existing transmitter

The changed item(s) (transmitter or sensor) can be identified and data copied as follows:

#### Transmitter

Select this option to copy data from the sensor memory to the transmitter memory and load the totalizer from the sensor memory.

The following changes can be made:

- Remote or Integral Cartridge change
- Remote Tx change
- New installation

#### Sensor

Select this option to copy data from the transmitter memory to the sensor and to load the totalizer from the sensor memory.

The following changes can be made:

- Integral Backplane change
- Sensor change
- Integral – Transmitter change

## 4 Passwords and Security Options

Password protection can be set to enable access at two levels; 'Standard' and 'Advanced'. Full end-user configuration is possible only by users that log on at the 'Advanced' level.

**Note.** There is no limit to the number of times a user can attempt to enter an incorrect password.

Passwords at both 'Standard' and 'Advanced' levels can be reset by 'Advanced' level users, but the existing password must be known before it can be changed. 'Standard' level passwords can be reset only by users with 'Standard' level access privileges.

**Note.** Once the passwords have been set, the read/write permissions are as follows:

- Access at the 'Read Only' level enables a reduced set of read-only parameters to be displayed – no password is required to access these parameters.
- Access at the 'Standard' level enables a set of standard read and write parameters to be displayed.
- Access at the 'Advanced' level enables all available end-user read/write parameters to be displayed.

### 4.1 Setting Passwords

#### 4.1.1 Default Passwords

The WaterMaster transmitter is supplied with default passwords for access to 'Standard' and 'Advanced' level menus.

The two passwords are:

- 'Standard' access password: 2 or blank
- 'Advanced' access password: 3 or blank

Passwords can contain up to 5 characters and are not case sensitive.

To prevent unauthorized access ABB recommend the default passwords are changed on commissioning.

**Note.** When allocating passwords, record a copy of each password and store in a safe location. It is not possible to interrogate the transmitter to 'recover' passwords once they have been set.

#### 4.1.2 Changing Passwords

Passwords are changed at the 'Device Setup'/'Access' level – see Section 5.2.2, page 16 for details.

### 4.2 Security/Anti-tamper Sealing

For MID compliant flowmeter / additional security, set the Read Only / MID Lock protection switch to 'ON' to ensure the meter is secure from tampering – see Fig. 3.2 on page 6. This switch option can be used in conjunction with physical anti-tamper security seals to provide maximum protection.

For HART software versions prior to 01.02.xx this switch prevents login via the keypad or bus at any security level. For HART software versions prior to 01.03.xx onwards and all PROFIBUS versions, on MID meters, all metrological-related parameters are locked and inaccessible at 'Service' level. 'Standard' and 'Advanced' level parameters can still be modified via the HMI or bus.

Refer to Instruction Manual (IM/WM) for anti-tamper seal locations.

## 5 Overview of Operator Pages and Menus

**Note.** For details of menu and parameter navigation, refer to IM/WMM, Section 5.1.

At power-up (if startup is successful) the process display (Operator page) is displayed. This is the normal operating state of the meter. Access to the 'Operator Menu' and the main menu (used for additional monitoring and to configure operation) is via an 'Operator' page – see Fig. 5.1. Each 'Operator' page can be configured to display flow information in single or multi-line formats. A bargraph option is also available to three of the formats – see Section 5.2.3, page 20.

If startup is not successful at power-up, an 'Operator' page is not displayed and alternative 'System Startup' screens are displayed. The system attempts to reset itself or enables changed system items to be identified and integrated – see Section 3.3, page 6.

### Operator Menu

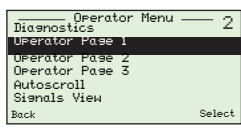

### Operator Page

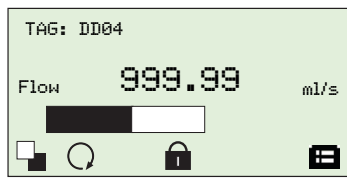

### Access Level

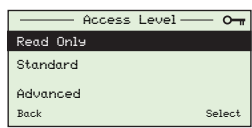



The 'Operator Menu' is used:

- to view current alarms (via the 'Diagnostics' menu),
- to select a single 'Operator Page' (1, 2 or 3) as the default display or to set the pages to 'Autoscroll' mode (autoscroll through each of the pages sequentially),
- to view active signals and their values (via the 'Signals View' menu).

Refer to Section 5.1, page 10 for details of these options.

### Operator Page Icons

**Autoscroll\***

The 'Autoscroll' (⦿) icon is displayed when 'Autoscroll' is enabled (selected at the 'Operator Menu', 'Autoscroll' option – see Section 5.1, page 10).

**Locked\* (Menu Access Denied)**

The 'Locked' (🔒) icon is displayed when access to the menus is denied to the current user due to a time-out or attempting to enter an incorrect password.

\*If an operational error is displayed, the 'Autoscroll' and 'Locked' icons are obscured (until the error is cleared).

The 'Access Level' is used to select access to menus at 'Read Only', 'Standard' and 'Advanced' levels.

To access these menus, scroll to the required level, press to display the 'Enter Password' screen and enter the correct password – see Section 4.1, page 8.

### User/Configuration Menus



See Section 5.2, page 12 for an overview of menus.

Fig. 5.1 Screen Navigation

## 5.1 Operator Menus

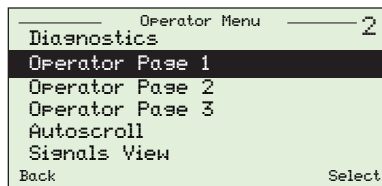

The 'Operator Menus' are accessed from an 'Operator Page' by pressing the key beneath the icon.

Three 'Operator' pages are available to monitor operation. These can be configured to display live measured values, totals and other available data.

**Note.** It is not possible to configure the system or to modify data from these 'Operator Menu' screens.

Display Overview	Section & Function
	<p><b>Diagnostics</b></p> <p>Select this menu to display active diagnostic system data.</p> <p>Use the  and  keys to scroll through all active diagnostics. Diagnostics in this screen do not include history information that is available from the 'Process Alarm'/'Diagnostic History' menu – see Section 5.2.5, page 25.</p> <p>Refer to Section 7.1.1, page 39 for a list of diagnostic alarms.</p>
	<p><b>Operator Page 1 (to 3)</b></p> <p>Setup of the 'Operator' pages is performed at the 'Display' menu by selecting the pre-configured display options.</p> <p>When an 'Operator' page (1, 2 or 3) is selected, it is displayed and 'Autoscroll' is suspended.</p>
	<p><b>Autoscroll</b></p> <p>When 'Autoscroll' is selected, the three 'Operator' pages (1, 2 or 3) are displayed sequentially and the transmitter remains in this display mode until an individual page is selected.</p>

Table 5.1 Operator Menus Overview





Display Overview	Section & Function									
 <p>The screenshot shows a menu titled "Signals View" with the following data:</p> <table border="1"> <tr> <td>E1</td> <td>3.03k</td> <td>Ω</td> </tr> <tr> <td>E2</td> <td>2.02k</td> <td>Ω</td> </tr> <tr> <td>OE1</td> <td>0.002V</td> <td></td> </tr> </table> <p>Navigation options: Back (bottom left), Exit (bottom right).</p>	E1	3.03k	Ω	E2	2.02k	Ω	OE1	0.002V		<p><b>Signals View</b></p> <p>Values of active signals are displayed as follows:</p> <ul style="list-style-type: none"> <li>■ Q Flowrate</li> <li>■ Q% Qmax%</li> <li>■ I Current Out mA</li> <li>■ v Velocity</li> <li>■ Σ+ Forward total</li> <li>■ Σ- Reverse total</li> <li>■ Σ Net total</li> <li>■ E1 Electrode resistance E1 kΩ</li> <li>■ E2 Electrode resistance E2 kΩ</li> <li>■ E1 Electrode voltage E1 V</li> <li>■ E2 Electrode voltage E2 V</li> <li>■ E12 Inter-electrode voltage V</li> <li>■ CDI Coil current mA</li> <li>■ CDR Coil and cable resistance (loop) Ω</li> </ul>
E1	3.03k	Ω								
E2	2.02k	Ω								
OE1	0.002V									

Table 5.1 Operator Menus Overview

## 5.2 Menus

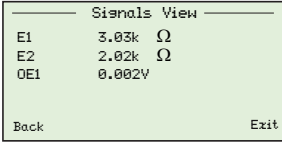
To access menus from an 'Operator Page', press the  key beneath the  icon and enter a user password. To scroll between menus, press the  and  keys.







Display Overview	Section and Function
	<p><b>Easy Setup</b> – see Instruction Manual (IM/WM)</p> <p>The 'Easy Setup' menu is used to set up the system quickly and contains a series of options for users with 'Standard' and 'Advanced' access permission. Users with 'Read Only' access cannot make selections from this menu.</p>
	<p><b>Device Info</b> – see Section 5.2.1, page 14</p> <p>Identifies plant item reference details such as tag/ID information and performance data.</p>
	<p><b>Device Setup</b> – see Section 5.2.2, page 16</p> <p>Used to specify plant, transmitter and sensor data settings.</p>
	<p><b>Display</b> – see Section 5.2.3, page 20</p> <p>Enables screen settings and the display format to be specified.</p>
	<p><b>Input/Output</b> – see Section 5.2.4, page 22</p> <p>Used for logic and pulse setup and current output settings.</p> <p><b>Note.</b> 'Current Output' menus are available on HART variant transmitters only.</p>
	<p><b>Process Alarm</b> – see Section 5.2.5, page 25</p> <p>Used to review and clear the alarm history and to set minimum and maximum flowrate alarm limits (not shown at 'Read Only' level).</p>

Table 5.2 Operating Menus Overview



Display Overview	Section and Function
	<p><b>Communication</b> – see Section 5.2.6, page 27</p> <p>Configuration of the transmitter's serial port and setup for HART communication (not shown at 'Read Only' level).</p> <p><b>Note.</b> Other communications options (for example PROFIBUS) are also available depending on the transmitter's communications type.</p>
	<p><b>Totalizer</b> – see Section 5.2.7, page 29</p> <p>Used to reset forward, reverse and net volume totalizers (not shown at 'Read Only' level).</p>
	<p><b>Diagnostics</b> – see Section 5.2.8, page 30</p> <p>Used to monitor diagnostic data and operate the meter in 'Simulation' mode.</p>
	<p><b>Service</b> – see Section 5.2.9, page 32</p> <p>Used to display transmitter span and zero information and to restore factory settings. This menu is displayed at 'Advanced' level access only.</p>

Table 5.2 Operating Menus Overview (Continued)

### 5.2.1 Device Info

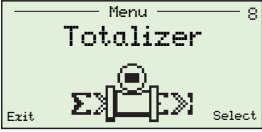

Contains equipment reference information including; version numbers, hardware location details, tag/ID details and conformance details.

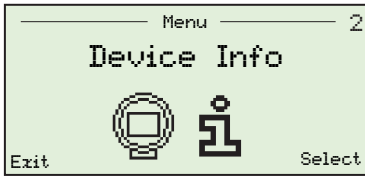
Parameter	Comment/Range	[Default] Note
Manufacturer	Displays the name or ID of the transmitter manufacturer.	[ABB]
Manufacturer Name	The name of the manufacturer.	[Factory set]
Address 1	The first line of the manufacturer's address.	[Factory set]
Address 2	The next line of the manufacturer's address.	[Factory set]
Contact	The manufacturer's telephone number.	[Factory set]
Sensor	Contains the following sub-parameters:	
Sensor Type	The model type of the sensor (for example WM Full Bore).	[Factory set]
Sensor Size	The sensor size (for example 'DN100').	<i>Dimension in mm</i>
Probe Pipe Bore	The probe bore size – this option only appears if 'Sensor Type' is 'Probe'.	<i>Dimension in mm</i>
QMax DN	The nominal maximum flowrate (Q3).	<i>Populated automatically</i>
TAG & ID	Options comprise: <ul style="list-style-type: none"> <li>■ Location TAG</li> <li>■ Sensor TAG</li> <li>■ Sensor ID</li> <li>■ SAP / ERP No.</li> </ul>	<i>Sensor-specific tag and ID numbers and SAP conformance number</i> [Factory set] [Factory set]
Term Board S/W	The software version of the sensor memory.	[Factory set]



Parameter	Comment/Range	[Default] Note
Sensor <i>(continued from previous page)</i> :		
Calibration	Options comprise: <ul style="list-style-type: none"> <li>■ First Cal. Date (including time)</li> <li>■ Last Cal. Date (including time)</li> <li>■ Cal. Cert Number</li> <li>■ Last Cal. Location</li> <li>■ Cal. Mode</li> <li>■ MID Status*</li> </ul>	Provides a record of sensor calibration details and sensor retrofit status.  [Factory set] [Geographical] [WaterMaster] [Non MID, Unlocked or Locked]
Properties	Options comprise: <ul style="list-style-type: none"> <li>■ Electrode Material</li> <li>■ Lining Material</li> <li>■ Sensor Run Hours</li> </ul>	The accumulated (total) hours of sensor operation
Transmitter		
TX Type	Options comprise: Model type of transmitter.	[WaterMaster]
TAG & ID	Options comprise: <ul style="list-style-type: none"> <li>■ TX TAG (description)</li> <li>■ TX ID (numerical)</li> <li>■ TX PIN (pin number)</li> <li>■ SAP / ERP No.</li> </ul>	[Factory set]
TX Version	Options comprise: <ul style="list-style-type: none"> <li>■ Application</li> <li>■ Application CRC</li> <li>■ HART F/W</li> <li>■ Bootloader</li> <li>■ H/W</li> </ul>	Version numbers (main application) Checksum HART firmware Bootloader Hardware
TX Run Hours	Accumulated hours transmitter of operation.	
TX Calibration	Options comprise: <ul style="list-style-type: none"> <li>■ First Cal. Date (including time)</li> <li>■ Last Cal. Date (including time)</li> </ul>	Provides a record of transmitter calibration details

\*Present only on Ver. 01.03.xx onwards.

## 5.2.2 Device Setup



Used to specify plant, transmitter and sensor data, including user access levels, security (password) codes and to set calibration parameters.

Parameter	Comment/Range	[Default] Note
Access	Used to change 'Standard' and 'Advanced' passwords – see Section 4, page 8.	[Timeout after 5 minutes. inactivity]
Standard Password	Alpha/numeric selection – a 'Standard' user can only edit 'Standard' passwords.	
Advanced Password	Alpha/numeric password selection of the 'Advanced' level password (not displayed at 'Standard' access level).	'Advanced' users can edit 'Standard' and 'Advanced' passwords
Client Enable	Options comprise: <ul style="list-style-type: none"> <li>■ HART Only</li> <li>■ HMI Only</li> <li>■ HMI/HART</li> </ul>	[HMI/HART] <i>Used to enable/disable the HMI or HART for control systems where local configuration changes need to be inhibited</i>
Read Only Switch	Options comprise: <ul style="list-style-type: none"> <li>■ Inactive</li> <li>■ Active</li> </ul>	<i>Displays the status of the 'Read Only' switch</i>
<b>Operating Mode</b>		
Meter Mode	Options comprise: <ul style="list-style-type: none"> <li>■ Forward And Reverse</li> <li>■ Forward Only*</li> <li>■ Reverse Only*</li> </ul>	[Forward & Reverse] <i>The meter mode can be set to respond to flow in the selected direction</i>
Flow Indication	Options comprise: <ul style="list-style-type: none"> <li>■ Normal</li> <li>■ Reversed</li> </ul>	[Normal] <i>Reverses the direction of flow for a meter installed backwards</i>

\*For MID-locked flowmeters (see Section 4.2, page 8) only 'Forward And Reverse' is permitted.

Parameter	Comment/Range	[Default] Note
Units		
Volume & Pulse Unit	Options comprise: <ul style="list-style-type: none"> <li>■ m<sup>3</sup></li> <li>■ l</li> <li>■ ml</li> <li>■ ft<sup>3</sup></li> <li>■ hl</li> <li>■ igal</li> <li>■ ugal</li> <li>■ bls (brew barrel)</li> <li>■ Ml</li> <li>■ Mugal</li> </ul>	[m <sup>3</sup> *]          <i>1 bls = 31 US gallons</i>
Q (Flowrate) Unit	Options comprise: <ul style="list-style-type: none"> <li>■ m<sup>3</sup>/s, m<sup>3</sup>/min, m<sup>3</sup>/h, m<sup>3</sup>/d</li> <li>■ ft<sup>3</sup>/s, ft<sup>3</sup>/min, ft<sup>3</sup>/h, ft<sup>3</sup>/d</li> <li>■ ugal/s, ugal/min, ugal/h, ugal/d</li> <li>■ Mugal/d</li> <li>■ igal/s, igal/min, igal/h, igal/d</li> <li>■ bls/s, bls/min, bls/h, bls/d (brew barrel)</li> <li>■ hl/h</li> <li>■ ml/s, ml/min</li> <li>■ l/s, l/min, l/h</li> <li>■ Ml/d</li> </ul>	[m <sup>3</sup> /h]          <i>1 bls = 31 US gallons</i>
Velocity Unit	Options comprise: <ul style="list-style-type: none"> <li>■ m/(s, min)</li> <li>■ cm/(s, min)</li> <li>■ ft/(s, min)</li> <li>■ in/(s, min)</li> </ul>	[m/s]
QMaxDN		[Sensor dependent] <i>Equivalent to OIML/ISO/CEN Q3</i>

\*For MID-locked flowmeters (see Section 4.2, page 8) this is fixed at m<sup>3</sup>.

Parameter	Comment/Range	[Default] Note
Probe	Only displayed if 'Sensor Type' is 'Probe'. Options comprise: <ul style="list-style-type: none"> <li>■ Probe Pipe Bore</li> <li>■ Insertion Factor</li> <li>■ Profile Factor</li> </ul>	<i>Pipe diameter in mm</i> <i>Refer to the Insertion Probe User Manual for further details</i>
QMax	0.02 <=Qmax/QmaxDN <= 2	[Sensor dependant]
Damping	Range: 0.02 to 60 seconds	[3 sec]
Low Flow Cutoff	Options comprise: <ul style="list-style-type: none"> <li>■ Flow Cutoff Level (0 to 10 % of QMax)</li> <li>■ Hysteresis (0 to 50 % of Flow Cutoff Level)</li> </ul>	[0 %*] <i>When flow is below the cutoff limit, meter output is 0</i> [20 %]
User Span	Range: -250 to 250 %	[100 %*] <i>Adjusts meter span (%)</i>
User Zero	Options comprise*: <ul style="list-style-type: none"> <li>■ Manual Adjust</li> <li>■ Auto Adjust</li> </ul>	[0]** <i>Adjusts meter zero in mm/s</i> <i>Before selecting the 'Auto Adjust' option, pipe conditions must be in a state of zero flow</i>
Mains Frequency	Set to 50 or 60Hz (corresponding to the local mains frequency).	[50 Hz]

\*For MID-locked flowmeters (see Section 4.2, page 8), 'User Span' is fixed at 100%, 'Low Flow Cutoff' and 'User Zero' are fixed at 0%.

\*\*The default value (0) is affected by the 'Auto Adjust' routine (the default value can be changed after an 'Auto Adjust' is run to suit operating conditions)

Parameter	Comment/Range	[Default] Note
*For MID-locked flowmeters (see Section 4.2, page 8) this is fixed at m <sup>3</sup> .		
Calibration Factors	Options comprise: <ul style="list-style-type: none"> <li>■ Span Ss</li> <li>■ Zero Sz</li> <li>■ Trim St</li> <li>■ Calibration Mode</li> <li>■ Sensor Cal</li> <li>■ Drive Mode</li> <li>■ Excitation Current</li> <li>■ Factory Cutoff</li> <li>■ Fact. Cutoff No. Av.</li> <li>■ Cal Status</li> <li>■ Sv</li> <li>■ Sc</li> <li>■ Coil Measurement F</li> </ul>	<p>[Factory set, Read only] all options</p> <p><i>Sensor span adjustment in %</i></p> <p><i>Sensor zero adjustment in mm/s</i></p> <p>[WaterMaster]</p> <p><i>Accuracy Class / OIML Certified (M10)</i></p> <p>[180 mA]</p> <p><i>In mm/s</i></p> <p><i>The points averaged in cutoff calculations</i></p> <p><i>Indicates if the sensor has been calibrated</i></p> <p><i>Sensor calibration factors</i></p>

### 5.2.3 Display



This menu is used to configure and format the information displayed, including: language, number of lines displayed (affects text size), bargraph options, screen contrast and number of decimal places for displayed data.

Parameter	Comment/Range	[Default] Note
Language	Selects the display language (English / German / French / Spanish / Italian / Polish).	[English]
Contrast	Increases/decreases the display contrast to suit local environmental conditions.	Use the ▲ and ▼ keys to increase/decrease contrast.
Operator Pages 1 (to 3)	Sets the number of lines and type of information to be displayed on each of the operator pages.	
Display Mode	Selects the number of lines of information and maximum number of characters displayed on each of the 'Operator' pages. Options comprise: <ul style="list-style-type: none"> <li>■ 1 x 6, 1 x 6 + Bargraph</li> <li>■ 1 x 9, 1 x 9 + Bargraph</li> <li>■ 2 x 9, 2 x 9 + Bargraph</li> <li>■ 3 x 9</li> </ul>	[1 x 6] <i>The unit of measure determines the number of characters displayed:</i> 1 x 6 displays one line with up to 6 characters, 2 x 9 displays two lines, each with up to 9 characters, 3 x 9 displays three lines, each with up to 9 characters, + Bargraph displays a Q % bargraph on the page.
1st Line (2nd Line) (3rd Line)	Specifies the type of information to be displayed on each page. Options comprise: <ul style="list-style-type: none"> <li>■ Volume Flowrate</li> <li>■ Q%</li> <li>■ Current Out</li> <li>■ Velocity</li> <li>■ Volume Forward</li> <li>■ Volume Reverse</li> <li>■ Volume Net</li> </ul>	

Parameter	Comment/Range	[Default] Note
Flowrate Format	Sets the number of decimal places for the displayed flowrate value. Options comprise: <ul style="list-style-type: none"> <li>■ x</li> <li>■ x.x to x.xxxxx (1 to 5 decimal places)</li> </ul>	[x.xx]
Volume Format	Sets the number of decimal places for the displayed volume value. Options comprise: <ul style="list-style-type: none"> <li>■ x</li> <li>■ x.x to x.xxxxx (1 to 5 decimal places)</li> </ul>	[x.xx]
Date / Time Format	Sets the date format. Options comprise: <ul style="list-style-type: none"> <li>■ DD-MM-YYYY</li> <li>■ MM-DD-YYYY</li> <li>■ YYYY-MM-DD</li> </ul>	[YYYY-MM-DD]
Display Test	Performs a self-test to verify the integrity of the display.	

## 5.2.4 Input/Output

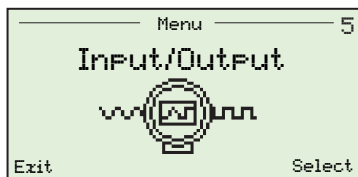

This menu is used to setup logic states, pulse states and current output settings.

**Note.** 'Current Output' menus are available on HART-variant transmitters only.

Parameter	Comment/Range	[Default] Note
Output Readings	Displays current output and pulse values.	'Current Output' menus are available on HART-variant transmitters only.
Current		[mA]
D01 Pulses (or) D01 State	Pulse output frequency (only one option is displayed).	[Hz] Context dependent, depending on 'DO1/DO2 Function' setting
D02 Pulses (or) D02 State	Logic output state – open/closed (only one option is displayed).	[Open] Context dependent
D03 State	High/Low output state (open/closed).	DO3 is Logic Out only
Output Setup	Configures the function of digital outputs DO1 and DO2.	Logic/pulse options selected at this menu determine options displayed at the 'Output Reading' and 'Logic Setup' menus
D01/DO2 Function	Options comprise: <ul style="list-style-type: none"> <li>■ Pulse F/Pulse R</li> <li>■ Pulse F/Logic</li> <li>■ Pulse FR/Logic</li> <li>■ Logic/Logic</li> </ul>	[Pulse FR/Logic] Forward/reverse pulse Forward pulse/logic output Pulse forward/reverse/logic
Logic Setup	Configures the function of the logic outputs.	If DO1 = Logic, the DO1 menu is displayed If DO2 = Logic, the DO2 menu is displayed
DO1 Logic	Options comprise:	[No Function]
DO2 Logic	<ul style="list-style-type: none"> <li>■ No Function</li> </ul>	
DO3 Logic	<ul style="list-style-type: none"> <li>■ F/R Signal (forward/reverse)</li> <li>■ Digital Out Alarm</li> </ul>	



Parameter	Comment/Range	[Default] Note
<i>Logic Setup (continued from previous page):</i>		
DO1 Config	Options comprise:	[Alarm = On, other options = Off]
DO2 Config	■ Alarm	
DO3 Config	■ Min. Alarm	
	■ Max. Alarm	
	■ Empty Pipe	
DO1 Action	Options comprise:	[Normally Open]
DO2 Action	■ Normally Open	
DO3 Action	■ Normally Closed	
<i>Pulse Setup</i>		
Volume & Pulse Unit	Options comprise:	[m <sup>3</sup> ]
	■ m <sup>3</sup>	
	■ l	
	■ ml	
	■ ft <sup>3</sup>	
	■ hl	
	■ igal	
	■ ugal	
	■ bls (brew barrel)	1 bls = 31 US gallons
	■ MI	
	■ Mugal	
Pulse Mode	Options comprise:	[Pulse/Unit]
	■ Pulse / Unit	<i>Configures the pulse system by setting Pulse/Unit or Fullscale Frequency</i>
	■ Fullscale Frequency	
Pulse Width*	Range: 0.09 to 2000.00 ms.	[5.00] ms <i>A minimum Pulse Width value allows a maximum Limit Frequency</i>
Limit Frequency*	Range: 0.25 to 5250 Hz.	<i>Limits the output at this frequency</i>
Fullscale Frequency	Only displayed if 'Pulse Mode' option 'Fullscale Frequency' is selected.	<i>In this mode, the output generates this frequency when Q % = 100</i>
Pulses / Unit	Only displayed if the 'Pulse Mode' option 'Pulse/Unit' is selected.	[1.0]

**\*Note.** 'Pulse Width' and 'Limit Frequency' parameters interact. Set the required 'Pulse Width' first, then the 'Limit Frequency'.

Parameter	Comment/Range	[Default] Note
Current Output	This menu is displayed on HART-variant transmitters only. Transmitters for other bus communications types do not have current outputs.	
Iout For EP Alarm	Options comprise: <ul style="list-style-type: none"> <li>■ Off</li> <li>■ Q=0%</li> <li>■ High Alarm</li> <li>■ Low Alarm</li> </ul>	[Off] <i>Empty pipe state – used to select the current output value when an empty pipe is detected</i>
Iout For Alarm	Options comprise: <ul style="list-style-type: none"> <li>■ High Alarm</li> <li>■ Low Alarm</li> </ul>	[Low Alarm] <i>The current output goes to high or low alarm value when in 'Alarm' state</i>
Low Alarm Value	Range: 3.5 to 3.6 mA	[3.6 mA]
High Alarm Value	Range: 21.0 to 23.0 mA	[21.8 mA]
Mode	4..20 mA or 4..12..20 mA <ul style="list-style-type: none"> <li>■ 4..20 mA</li> <li>■ 4..12..20 mA</li> </ul>	[4..20 mA] 4 mA represents Q = 0% 20 mA represents Q = +100% 4 mA represents Q = -100% 12 mA represents Q = 0% 20 mA represents Q = +100%

**5.2.5 Process Alarm**

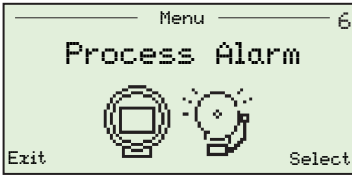

Used to review and clear the alarm history and to set minimum and maximum flowrate alarm limits.

Parameter	Comment/Range	[Default] Note
Diagnostic History	<p>Displays a list of alarms (since last clear alarms command). Includes a count of occurrences, total duration and time since the last occurrence.</p> <p>Data is displayed in the following format:</p>	<p>[None]</p> <p>Use the  and  keys to scroll through the list of alarms</p> <p><i>n</i> = The number of times alarm has been activated</p> <p><math>\Sigma t</math> = Total time alarm has been active</p> <p><i>tn</i> = The elapsed time since this alarm was activated*</p>
Clear Alarm History	Clears the alarm history.	
Group Masking	Selects groups of alarms to be masked or enabled (the 'Failure' group cannot be masked).	Alarm groups are identified in Section 7.1, page 31.
Maintenance Required	On/Off	[Off]
Function Check	On/Off	[Off]
Out of Specification	On/Off	[Off]
Individual Masking		
Min. Alarm	On/Off	[Off]
Max. Alarm	On/Off	[Off]
Overrange 103%	On/Off	[Off]

\*If power to the transmitter is lost, this value is frozen for the alarm that occurred immediately before the power failure.

---

Parameter	Comment/Range	[Default] Note
Flowrate Limits	Min. Alarm: 0.00 to 130.00 %. Max. Alarm: 130.00 to 0.00 %.	[0] [110.00] <i>Software inhibits Min. Alarm/Max. Alarm value overlap</i>
Alarm Simulation	Enables any alarm type output to be selected and simulated. Selection is made from a list of alarms such as 'No Sensor', 'Empty Pipe' etc.	[None] <i>Ensure this option is set to 'None' during normal operation</i>

---

**5.2.6 Communication**

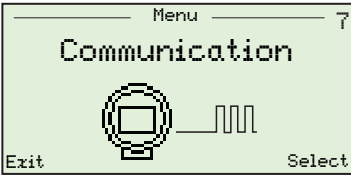

Used to configure the transmitter service port and HART parameters.  
Parameters at this level are accessible only by 'Advanced' users.

Parameter	Comment/Range	[Default] Note
HART	Configures HART communication parameters. <b>Note.</b> This menu is displayed for all communication variants, but is enabled for HART-variant transmitters only.	
Device Address	Enters a device address (0 to 15).	[0] <i>Use addresses 1 to 15 for multidrop mode</i>
HART TAG	Specifies a unique tag (alpha/numeric character set).	<i>8 characters maximum</i>
HART Descriptor	Specifies a unique description (alpha/numeric character set).	<i>16 characters maximum</i>
Manufacturer ID	The factory-set ID of the manufacturer.	[26]
Last HART Command	View last received HART command number.	
Current Output HART	Sets HART current output mode. <b>Note.</b> 'Current Output' menus are available on HART variant transmitters only. (Uninterruptible/Auto).	[Uninterruptible] <i>In 'Uninterruptible' mode, HART operation over the service port is disabled. In 'Auto' mode, HART operation over the service port is enabled</i>  <i>Note. If service port HART is in use, the current output HART is suspended</i>
Device Message	Displays a device message.	Up to 32 characters

Parameter	Comment/Range	[Default] Note
Cyclic Data Out	Displays a regular, updated table of information over the service port.	[1 s] <i>Cyclic data can be output to PC via the (optional) Service Port Splitter/Adaptor – refer to Section 8.5, page 56 to run a Cyclic Data Out routine</i>
Cyclic Update Rate	The rate cyclic data is updated (range: 0.2 to 3600.00 s).	
Cyclic Update Sel.	Each group can be enabled or disabled according to the cyclic data types to be updated and (optionally) output to a PC. Options comprise: <ul style="list-style-type: none"> <li>■ Flow Group</li> <li>■ Outputs Group</li> <li>■ Electrodes Group</li> <li>■ Status Group</li> <li>■ Coil Group</li> <li>■ TX Group</li> <li>■ Vol. Totals Group</li> </ul>	[Disabled]
Service Port	Sets the Baud rate.	
Max Baud Rate	Baud rate options (bps): <ul style="list-style-type: none"> <li>■ 2400</li> <li>■ 4800</li> <li>■ 9600</li> <li>■ 19200</li> <li>■ 38400</li> </ul>	[38400 bps]

### 5.2.7 Totalizer

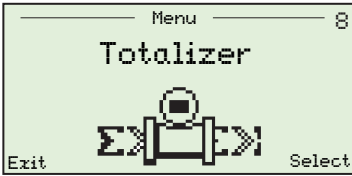

Enables individual resetting of forward, reverse and net volume data by 'Advanced' users.

Parameter	Comment/Range	[Default] Note
Reset Totalizer	Resets the totalizer data.	[N/A]
Volume FWD	Resets the forward volume	<i>For MID-locked flowmeters (see Section 4.2, page 8) all totalizer resets are inhibited.</i>
Volume REV	Resets the reverse volume	
Volume NET	Resets the net volume	
All Volume	Resets all volume totals	

## 5.2.8 Diagnostics



Enables simulations to be run. Diagnostic data is configured at the Factory and parameters can be modified by 'Advanced' users only.

Parameter	Comment/Range	[Default] Note
Simulation	When the 'Simulation' level is entered, the selected sub-menu (excluding 'Off') appears beneath the 'Simulation Mode' menu enabling a simulation value to be entered.	
Simulation Mode	Options comprise: <ul style="list-style-type: none"> <li>■ Off</li> <li>■ Flow Velocity</li> <li>■ Q</li> <li>■ Q% (-200.00 to 200.00 %)</li> <li>■ Iout (3.5 to 23 mA)</li> <li>■ Logic 1 [Pulse 1]</li> <li>■ Logic 2 [Pulse 2]</li> <li>■ Logic 3 [Pulse 3]</li> <li>■ HART Freq (1200 Hz or 2400 Hz)</li> </ul>	[Off] [m/s] [m <sup>3</sup> /h] [4 mA] <i>Menu displayed (Logic/Pulse) is dependant on Input/Output DO1/DO2 settings</i> [1200 Hz]
Measurements	Comprising: <ul style="list-style-type: none"> <li>■ Elec. R E1</li> <li>■ Elec. R E2</li> <li>■ DC Back Off V (internal voltage)</li> <li>■ Coil &amp; Cable R</li> <li>■ Coil L</li> <li>■ Sensor L Shift</li> <li>■ TX. AV. Gain Shift</li> </ul>	<i>Electrode 1 resistance</i> <i>Electrode 2 resistance</i> <i>Electrode voltage differential</i> <i>Coil and cable resistance</i> <i>Coil inductance</i> <i>Coil inductance shift</i> <i>Transmitter auto-cal gain shift</i>



Parameter	Comment/Range	[Default] Note
Limits	Comprising: <ul style="list-style-type: none"> <li>■ Elec. R Alarm Max EP (empty pipe)</li> <li>■ Elec. R Alarm Min (Electrodes)</li> <li>■ Elec. V +Limit</li> <li>■ Elec. V –Limit</li> <li>■ Elec. V Diff. Limit</li> <li>■ Coil I Alarm Band</li> <li>■ Coil O/C R Limit</li> <li>■ Coil S/C R Limit</li> </ul>	['Limits' are factory set] <i>Maximum resistance trip level</i> <i>Resistance trip for short circuit detection</i>
Velocities	Comprising: <ul style="list-style-type: none"> <li>■ Signal <math>\mu\text{V}/\text{mA}</math></li> <li>■ TX Cal'd Velocity</li> <li>■ Snsr Cal'd Velocity</li> <li>■ Snsr User Velocity</li> </ul>	<i>The raw signal level in <math>\mu\text{V}/\text{mA}</math></i> <i>For calibrator equipment use</i> <i>Fluid velocity in the sensor (Factory settings)</i> <i>Fluid velocity in the sensor (User settings)</i>
NVRAM	Comprising: <ul style="list-style-type: none"> <li>■ Write errors</li> <li>■ Read Errors</li> <li>■ Verify Errors</li> <li>■ Transmitter Restores</li> <li>■ Sensor Restores</li> <li>■ Plant Restores</li> <li>■ WW Sensor Restores</li> <li>■ Summary Alarm</li> </ul>	[Read only] <i>A count of errors written for the non-volatile memory</i>
ABB Diagnostics	Comprising: <ul style="list-style-type: none"> <li>■ 0x0000000000</li> </ul>	<i>Service information code</i>

### 5.2.9 Service

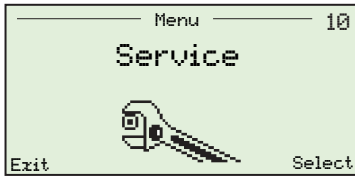

The 'Service' menu enables 'Advanced' level users to view transmitter span and zero information and to restore as-supplied factory settings.

Parameter	Comment/Range	[Default] Note
Transmitter	Available at 'Advanced' level only.	
TX Span	Read-only factory-adjustment transmitter span value.	[100 %]
TX Zero	Read-only factory-adjustment transmitter zero value.	[0.0000 mm/s]
User Defaults	Available at 'Advanced' level only.	
Restore	Used to restore as-supplied factory settings.	[Factory settings]

## 6 HART®-Protocol

**Note.** This section is applicable to HART-variant transmitters only.

### 6.1 Overview

WaterMaster transmitters can be ordered as HART-compatible, factory-calibrated devices. HART-Protocol enables simultaneous indication of process variables and digital communication. The 4 to 20 mA current output signal (minimum load 250 Ω) transmits process information and the digital signal is used for bi-directional communication. The analog process value output enables analog indicators, recorders and controllers to be used, while the simultaneous digital communication uses HART-Protocol.

### 6.2 Hardware and Software Requirements

Item	Description
Device Manager (Hardware)	<p>Install a HART modem (FSK [Frequency Shift Keyed]-Modem) for HART-Communication when connecting to a PC.</p> <p>The HART-Modem converts the analog 4 to 20 mA signal into a digital output signal (Bell Standard 202) and connects to the PC using a USB (or RS232C) connector.</p> <p>Alternatively, a hand-held terminal can be used (see below).</p>
Compatible Management Software	<p>Management software required to communicate with HART-compatible instruments using 'Universal' and 'Common Practice' commands.</p>
Hand-held Terminal	<p>The transmitter can be accessed and configured using a compatible hand-held terminal (such as the HART HHT Type 375 or equivalent).</p> <p>Transmitter connection is made in parallel with the 4 to 20 mA current output – refer to Instruction Manual (IM/WM), Current Output (4 to 20 mA) for terminal connection details.</p>

Table 6.1 HART-Protocol – Hardware/Software Requirements

### 6.3 HART-Protocol Configuration

HART-variant WaterMasters are read and configured using Common Practice and Universal commands for the following parameters:

- Q
- QMax (PV, URV)
- Damping
- Iout
- Loop Test (4 to 20 mA)
- HART Descriptor
- HART Tag
- HART Device Message

### 6.4 HART-Protocol Connection

Fig. 6.1 shows HART-Protocol connection details for WaterMaster installations.

**Note.**

- Current output connection details are common for both remote and integral transmitters
- The HART-Protocol is also available optically via the infrared service port adaptor – see Section 8, page 48

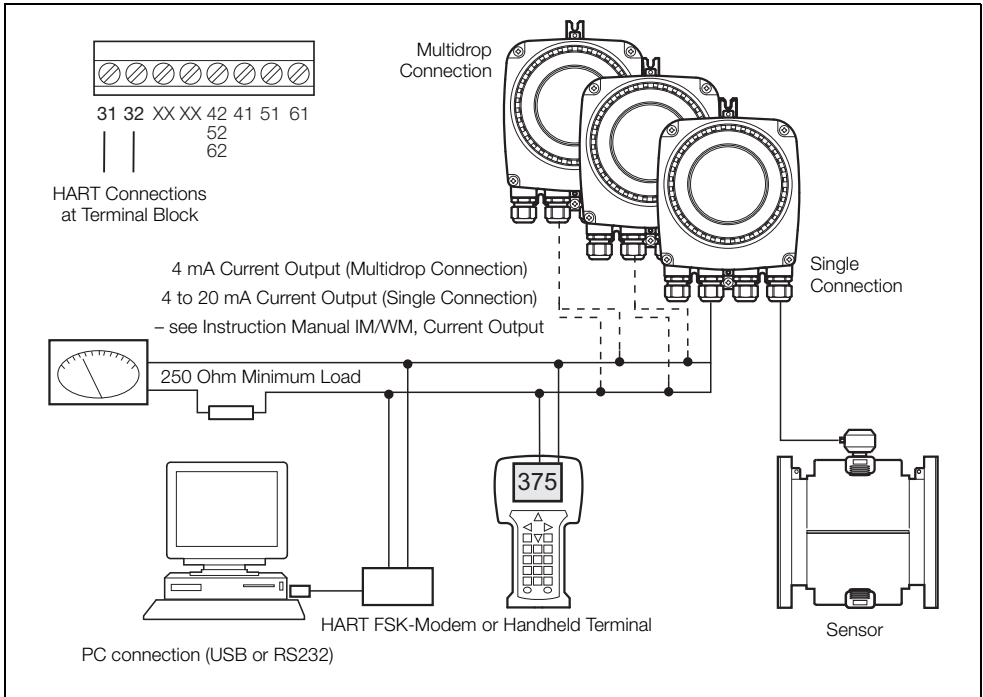

Fig. 6.1 HART-Protocol Connection (Remote Installation Shown)

## 6.5 HART-specific Device Type Manager (DTM FEX100 HART)

**Note.** HART-variant WaterMasters are compatible with the HART-specific DTM (DTM FEX100 HART) only. DTM's for other communications bus options (for example PROFIBUS) must match the transmitter variant – refer to DS/WM-EN for system options and ordering details.

WaterMaster can be integrated into control systems and configuration devices using any Frame application, such as ABB AssetVision or similar third-party applications. ABB Device Type Managers (DTMs) for WaterMaster provide a unified structure for accessing device parameters, configuring and operating the devices and diagnosing problems. FDT (Field Device Tool) technology standardizes the communication and configuration interface between all field devices and host systems.

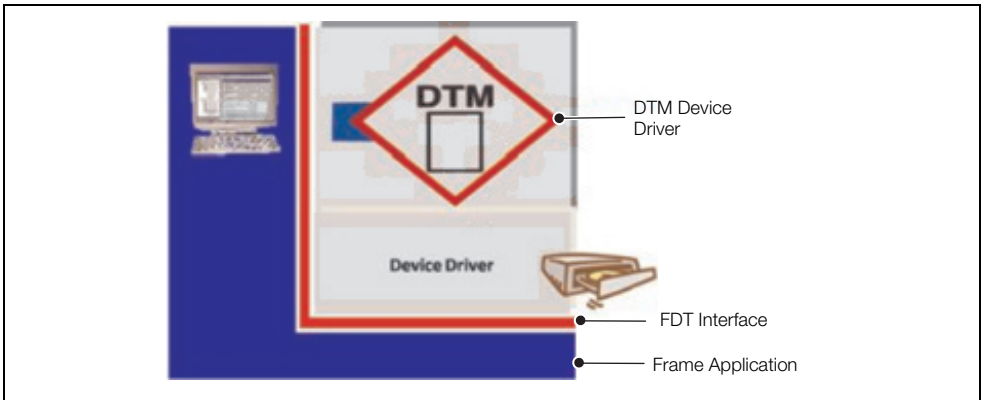

Fig. 6.2 Example Frame Application

### 6.5.1 Supported Devices (DTM FEX100 HART)

FEX100 HART WaterMaster Electromagnetic Flowmeter with HW Rev 02\*, SW Version 01.02.00\*\* or later and Device Version 00\*\*\* or higher.

Earlier software versions can be re-flashed to enable support for this DTM – contact ABB Service for further information.

The DTM can be used either on the current loop 4 to 20 mA HART or via the front panel using the infrared coupler and ABB Service Port Splitter – see Section 8, page 48. When using the Service Port Splitter, enable a COM channel for the HART client and identify this COM channel number in the frame application.

\* HW Rev is located on the WaterMaster Cartridge housing label.

\*\* SW Version is in the HMI Menu at 'Device Info / Transmitter / TX Version / Application' or HART command 136 slot 0.

\*\*\* Device Version is obtained using HART command 0.

### 6.5.2 DTM (Driver) Version Record

The Device DTM should be usable in all frame applications meeting the requirements of FDT 1.2/1.2.1.

Released Driver Version	Release Date	Release Bundle / Library	Remarks
05.00.00	Oct. 2009	05.00.05/05.00.12	Initial release

Table 6.2 DTM (Driver) Version Record

### 6.5.3 PC Hardware / Operating System Requirements

The following hardware / software is required:

- Processor – Intel compatible (2GHz)
- 512 Mb RAM
- Windows 2000 SP4 / XP SP2 or SP3 / VISTA
- Microsoft .NET Framework 2.0
- Microsoft Internet Explorer 6.0 or a similar internet browser

### 6.5.4 Obtaining the WaterMaster Device DTM

Download the WaterMaster Device DTM from the ABB website:

<http://www.abb.com/product/seitp330/43036b0a80621b48c12573de003d803a.aspx>

### 6.5.5 Installing the WaterMaster Device DTM

To install the WaterMaster DTM Device Driver:

1. Close all FDT applications.
2. Unzip the WaterMaster Device DTM zip file and run 'Setup.exe' from the main folder.
3. Follow the on-screen prompts to complete the installation.

### 6.5.6 Updating the WaterMaster Device DTM

Newer versions of the WaterMaster Device DTM can be installed over older versions. To revert to an older version, uninstall the existing (newer) installation before installing the older version.

### 6.5.7 Getting Help and Further Information

Press F1 on the WaterMaster Device DTM window activates the online help system.

Help relating to the integration of the WaterMaster Device DTM in the FDT frame application is within the respective documentation of the frame application.

### 6.5.8 Uninstalling the WaterMaster DTM

To uninstall the WaterMaster Device DTM:

1. Open the PC's 'Start / Settings / Control Panel' window and select 'Add or Remove Programs'. Select 'ABB DTM500'.
2. To remove the WaterMaster Device DTM only, select 'Change'. The following menu is displayed:

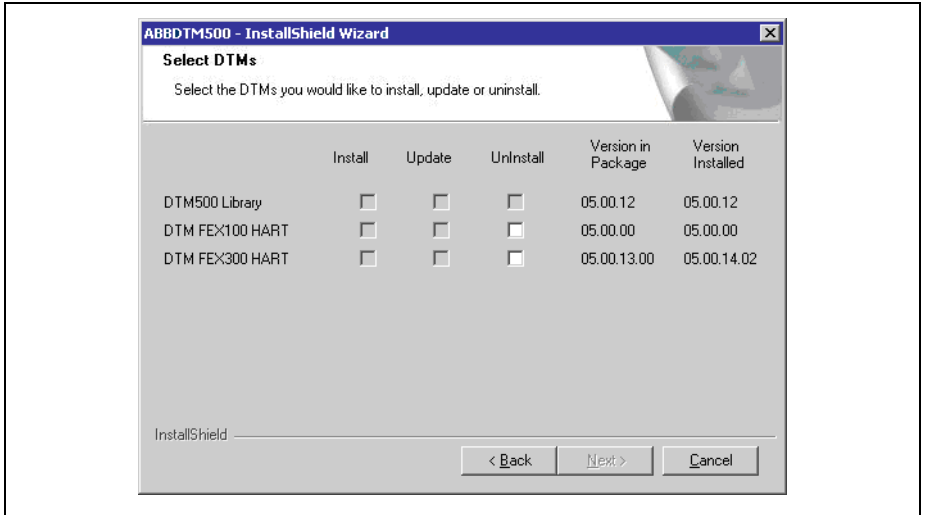

Fig. 6.3 ABBDTM500 InstallShield Wizard Dialog

3. Check the 'Uninstall' option for 'DTM FEX100 HART' and click 'Next'.
4. Follow the on-screen prompts to complete the uninstall procedure.

**Note.** To remove all ABB Device DTMs based on the DTM500 Library, and the DTM Library files, select 'Remove' from the 'Add or Remove Programs' dialog, then follow the on-screen prompts.

## 7 Troubleshooting

### 7.1 Alarms

Alarm codes and icons conforming to the NAMUR NE107 classification code are used to define errors during operation and data entry. An overview of a typical alarm code is shown in the following diagram:

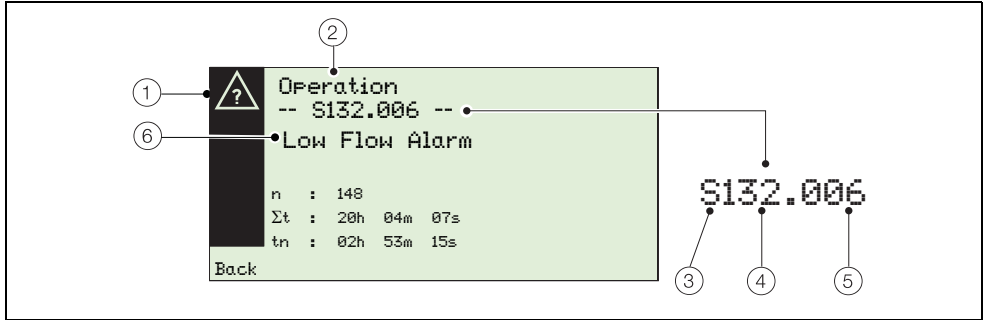

Fig. 7.1 Example Alarm Code and Components





Item	Description	Item	Description
①	Status Icon (associated with NAMUR classification code) ③): <ul style="list-style-type: none"> <li>■  Maintenance Required</li> <li>■  Out of Specification</li> <li>■  Check Function</li> <li>■  Failure</li> </ul>	④	Alarm Priority: <ul style="list-style-type: none"> <li>■ None 001 to 050</li> <li>■ Maintenance 051 to 100</li> <li>■ Out of Specification 101 to 150</li> <li>■ Check Function 151 to 200</li> <li>■ Failure 201 to 250</li> </ul>
②	Group Name: <ul style="list-style-type: none"> <li>■ Electronics</li> <li>■ Sensor</li> <li>■ Configuration</li> <li>■ Operation</li> </ul>	⑤	Alarm Number: <ul style="list-style-type: none"> <li>■ Minimum 000</li> <li>■ Maximum 099</li> </ul>
③	NAMUR Classification Code: <ul style="list-style-type: none"> <li>■ M Maintenance Required</li> <li>■ S Out of Specification</li> <li>■ C Check Function</li> <li>■ F Failure</li> </ul>	⑥	Alarm Text: <ul style="list-style-type: none"> <li>■ Text comprises a unique message associated with the alarm code displayed.</li> <li>■ For alarm codes and alarm text, see Section 7.1.1, page 39</li> </ul>

Table 7.1 Alarm Code Components



**7.1.1 Alarm Codes**

The following list of alarm codes can be used for troubleshooting and alarm diagnosis:

<b>Alarm Code &amp; Displayed Message</b>	<b>Description</b>	<b>Possible Cause(s)</b>	<b>Corrective Measure(s)</b>
_030.012 Totalizer reset.	The totalizer has been reset to zero.	The user requested a totalizer reset.	None
_044.014 HART multidrop enabled. Current output = 4mA.	The HART Instrument Address is not 0. <b>Note.</b> Applicable to HART transmitters only.	Address 1 to 15 selected. Therefore the current output is frozen at 4mA (HART Multidrop).	Select Address 0 if a 4 to 20mA output is required.
M080.011 At Qmax, volume display overrun <1600hrs. Adjust units or resolution.	With a flow rate equal to Qmax, the 'Volume' display overruns in less than 1,600 hours.	Inappropriate 'Display Format' or 'Volume Units' choice for this meter size.	Adjust the 'Volume Display Format' setting to use less digits after the decimal point. Select different 'Volume Units' for this meter size.
M090.013 Intermittent sensor comms. Check sensor wiring?	Intermittent data communications detected between the transmitter and the remote sensor electronics.	This error occurs only on remote sensor systems that have electronics housed in the remote sensor assembly. Sensor cable defective; open or short-circuit; poor connections. Defective sensor electronics.	Check sensor cable and its connections. Contact local representative.

Table 7.2 Alarm Codes

Alarm Code & Displayed Message	Description	Possible Cause(s)	Corrective Measure(s)
M094.033 Current output hardware fault. Contact service.	Communications fault detected in the circuit for the current output. <b>Note.</b> Applicable to HART transmitters only.	Defective transmitter cartridge electronics.	Replace cartridge. Contact local representative.
M098.031 OIML self-check limits exceeded. Contact service.	Transmitter or sensor OIML self-check values have been detected out of range.	Unexpected degradation of key transmitter or sensor measurement parts.	Contact local representative.
S105.030 Accuracy warning? Electrode volts problem.	Accuracy potentially affected by high electrode voltages.	High absolute electrode voltages. Absolute electrode voltage limits configuration.	Investigate/correct electrode voltage problem. Check sensor cross bonding is in accordance with the manual. Consider installing an additional ABB stainless steel fluid contact ring. Contact local representative.
S110.034 Sensor setup not complete. Finish setup, set 'Cal Status'	System calibration not completed correctly.	System calibration procedure not completed correctly.	If the transmitter is a retrofit to an old sensor, contact local representative for upgrade procedure.

Table 7.2 Alarm Codes (Continued)

Alarm Code & Displayed Message	Description	Possible Cause(s)	Corrective Measure(s)
S132.006 Low flow alarm.	Flow rate is below the 'Minimum Alarm' limit.	Low flow rate. 'Minimum Alarm' limit not configured correctly.	Increase flow rate. Decrease the value of the 'Minimum Alarm' limit.
S136.007 High flow alarm.	Flow rate is above the 'Maximum Alarm' limit.	High flow rate. 'Maximum Alarm' limit not configured correctly.	Reduce flow rate. Increase the value of the 'Maximum Alarm' limit.
S140.008 Current output limited Q >103% Qmax. Check Qmax?	Flow rate is above 103 % of 'Qmax' limit. 4 to 20 mA output is saturated. Volume totalizer still operates. <b>Note.</b> Applicable to HART transmitters only.	High flow rate. 'Qmax' setting too low.	Reduce flow rate. Increase the value of 'Qmax'.
S146.022 Short circuit electrode. Check?	A short-circuit electrode has been detected.	Electrode fault. Bad connection. 'Elec R Alarm Min' set too low.	Investigate/repair electrode circuit. Check the 'Electrode R Alarm Min.'. Check electrode signal cables to ensure there is not a short circuit between the screen and inner cores, on terminals E1, S1, E2, S2. Contact local representative.

Table 7.2 Alarm Codes (Continued)

<b>Alarm Code &amp; Displayed Message</b>	<b>Description</b>	<b>Possible Cause(s)</b>	<b>Corrective Measure(s)</b>
S147.021 Open circuit electrode. Check wiring? Electrode coated	An open-circuit electrode has been detected.	Broken electrode wire or cable fault. Bad connection. Electrode 'Elec R Alarm Max EP' set too low.	Investigate/repair electrode circuit. Check the 'Electrode R Alarm Max. EP'. Contact local representative.
S148.032 Measurement starting.	The Measurement System is checking and initializing the electronics before starting flow measurements.	Power up or reset has occurred.	None: this alarm is expected to occur during device start up.
S150.018 Empty pipe  If full, check EP trip limit.	Empty pipe conditions have been detected.	The pipe is empty and the electrodes are not in contact with fluid.  If the pipe is full, the 'Electrode R Alarm Max. EP Limit' may not be configured correctly.	Ensure meter pipe is full. Check the 'Electrode R Alarm Max.EP Limit'. Contact local representative.
C158.038 HART frequency simulation active.	The HART output is simulating one of the two signalling frequencies.  <b>Note.</b> Applicable to HART transmitters only.	Simulation mode is enabled and the HART frequency is being driven with a user-selected value.	Stop simulation of HART output frequency.

Table 7.2 Alarm Codes (Continued)

<b>Alarm Code &amp; Displayed Message</b>	<b>Description</b>	<b>Possible Cause(s)</b>	<b>Corrective Measure(s)</b>
C160.005 Logic simulation selected on OP3.	OP3 output is being simulated.	Simulation mode is enabled and the OP3 logic output state is being driven with a user-selected value.	Stop simulation of OP3 logic output.
C164.003 Logic simulation selected on OP2.	OP2 output is being simulated.	Simulation mode is enabled and the OP2 logic output state is being driven with a user-selected value.	Stop simulation of OP2 logic output.
C168.001 Logic simulation selected on OP1.	OP1 output state is being simulated.	Simulation mode is enabled and the OP1 logic output state is being driven with a user-selected value.	Stop simulation of OP1 logic output.
C172.004 Pulse simulation selected on OP2.	OP2 output frequency is being simulated.	Simulation mode is enabled and the OP2 frequency output is being driven with a user-defined value.  This enables the output frequency to be checked with a counter.	Stop simulation of OP2 frequency output.
C174.002 Pulse simulation selected on OP1.	OP1 output frequency is being simulated.	Simulation mode is enabled and the OP1 frequency output is being driven with a user-defined value.  This enables the output frequency to be checked with a counter.	Stop simulation of OP1 frequency output.

Table 7.2 Alarm Codes (Continued)

Alarm Code & Displayed Message	Description	Possible Cause(s)	Corrective Measure(s)
<p>C178.000 Simulated/fixed current output. HART address &gt;0? Simulation mode?</p>	<p>Current output is set to a fixed value. <b>Note.</b> Applicable to HART transmitters only.</p>	<p>The 4 to 20 mA output is being simulated using a chosen value. This enables the current at the connection terminals to be checked with test equipment.  The HART Instrument Address is not 0 so HART Multidrop mode is active (current out fixed to 4mA).</p>	<p>Stop simulating 4 to 20 mA output. Set HART address to 0.</p>
<p>C182.009 Simulation mode On.</p>	<p>Flow rate or flow velocity value is being simulated.</p>	<p>Simulation Mode is enabled and either flow rate or flow velocity is being simulated using a chosen value.  The outputs correspond to the simulated value set.</p>	<p>Stop simulation of flow rate or flow velocity.</p>
<p>C186.010 Tx. simulator/calibrator mode.</p>	<p>The transmitter is using a calibrator or simulator.</p>	<p>The calibrator or simulator sensor electronics has been configured for calibrator or simulator use.</p>	<p>Remove transmitter from calibrator or simulator.</p>

Table 7.2 Alarm Codes (Continued)

<b>Alarm Code &amp; Displayed Message</b>	<b>Description</b>	<b>Possible Cause(s)</b>	<b>Corrective Measure(s)</b>
C190.039 Alarm simulation active.	An alarm is being simulated.	An operator action has caused an alarm to be simulated.	Stop the alarm simulation.
F220.017 Tx. measurement suspended. Contact service.	Measurement suspended.	Hi differential voltage or above limit level.	Remove cartridge. Check sensor cross-bonding, or high levels of mains pickup occurring. Contact local representative/replace cartridge.
F230.029 Bad flow data.  Check wiring? Contact service.	Problem with data obtained by the transmitter measurement system.	Out of bounds data values detected by the measurement system. Sensor wiring or cable fault.	Investigate/repair sensor wiring and connections. Check sensor cross-bonding or high levels of mains pickup occurring. Contact local representative.
F232.028 Transmitter hardware fault. Contact service.	A problem with the transmitter electronics has been detected.	Defective transmitter cartridge electronics.	Replace cartridge. Contact local representative.

Table 7.2 Alarm Codes (Continued)

<b>Alarm Code &amp; Displayed Message</b>	<b>Description</b>	<b>Possible Cause(s)</b>	<b>Corrective Measure(s)</b>
F234.027 Check cable+coil resistance. Cable too long? Sensor Fault? Contact service.	An out-of-range loop resistance has been detected.	Sensor wiring or cable altered or faulty.	Investigate/correct loop circuit problem. Contact local representative.
F236.026 Short circuit coil/wiring. Check wiring?	A short-circuit coil has been detected.	Sensor wiring or cable fault.	Investigate/correct coil circuit problem. Contact local representative.
F238.025 Open circuit coil/wiring. Check wiring?	An open-circuit coil has been detected.	Sensor wiring or cable fault. 'Coil Open Circuit Resistance Limit' configuration.	Investigate/correct coil circuit problem. Check the 'Coil Open Circuit Resistance Limit' configuration. Contact local representative.
F247.024 Installation fault/condition. Electrode problem?	A problem with the installation's electrode potentials has been detected.	High differential electrode voltage. Differential electrode voltage limits configuration.	Investigate/correct electrode voltage problem. Ensure sensor is cross-bonded to pipeline. Contact local representative.

Table 7.2 Alarm Codes (Continued)



<b>Alarm Code &amp; Displayed Message</b>	<b>Description</b>	<b>Possible Cause(s)</b>	<b>Corrective Measure(s)</b>
F248.035 Incompatible sensor. Contact service.	Incompatible transmitter and sensor calibration modes detected.	The transmitter and sensor calibration modes are not matched and the transmitter and sensor must not be used together.	Contact local representative.
F248.040 Non-volatile summary alarm Error in Tx. NV storage device. Contact service.	A memory fault has been detected in the transmitter's non-volatile memory.	A CRC failure was detected in the non-volatile memory. Defective transmitter cartridge electronics.	Replace cartridge. Contact local representative.
F250.015 Tx. memory fault detected. Contact service.	Communications fault detected with the on-board transmitter memory.	Memory circuit in the transmitter cartridge is defective.	Replace cartridge. Contact local representative.
F252.016 Sensor memory not detected. Offline mode? Check wiring? Check switches?	No sensor memory detected.	No sensor connected. Meter in 'Off-Line' mode.	Check sensor cable and its connections. Connect a sensor. If using an Integral meter check the backplane dip switch configuration – see Fig. 3.2 on page 6. Contact local representative.
F253.036 Tx. code memory fault. Contact service.	Corrupted firmware detected in the transmitter.	A CRC failure was detected in the ROM code memory of the transmitter. Defective transmitter cartridge electronics.	Contact local representative.
F254.037 Tx. data memory fault. Contact service.	A memory fault detected in the transmitter.	A write/read failure detected in the data memory of the transmitter. Defective transmitter cartridge electronics.	Replace cartridge. Contact local representative.

Table 7.2 Alarm Codes (Continued)

## 8 Remote Computer Connection

### 8.1 Utility Software for PC

WaterMaster transmitters can be operated and configured via a PC if the Utility Software is installed (see Section 8.2, page 49) and the optional service port adaptor is connected (see Section 8.3, page 50).

**Note.** The Utility Software CD is supplied with the optional service port adaptor.

The Utility Software also enables cyclic data and parameter data to be downloaded and saved to a compatible spreadsheet application such as Excel – see Section 8.5, page 56 and Section 8.6, page 57.

The following table provides an overview of the utilities required for remote operation:

Utility	Function
USB Service Port	<i>Driver</i> – a Windows software driver required for the service port adaptor to run. <i>Installation Guide</i> – driver installation guides for Windows XP or Windows 2000 operating systems.
Microsoft .NET Framework	A Microsoft environment required for the Service Port Splitter service to run.
Service Port Splitter (Comms. Port Driver)	An ABB driver required to manage data (including error detection) sent from the transmitter to a PC's physical port – see Section 8.4, page 51 for configuration details. <b>Note.</b> When the service is running, transmitter data is multiplexed to specific client applications connected via up to four virtual COM ports.
Remote HMI	An ABB PC application that supports a remote HMI for WaterMaster and ProcessMaster transmitters – see Section 8.7, page 58.

Table 8.1 Overview of Utility Software for PC

## 8.2 Installing the Utility Software

To install the Utility Software onto a PC:

1. Insert the Utility Software CD into the PC's CD drive.

The installation screen is displayed automatically:



2. Install the utilities listed in Table 8.1, page 48.
3. When all utilities have been installed, click 'Exit' and restart the PC.
4. Attach the service port adaptor to the transmitter and connect the USB cable to the PC – see Section 8.3, page 50.
5. Configure the Service Port Splitter, see Section 8.4, page 51.

### 8.3 Attaching the Service Port Adaptor to the Transmitter

The service port adaptor is attached to the transmitter glass area by two suction pads and connected to the PC via the USB cable – see Fig. 8.1.

**Caution.**

- Ensure the glass screen and the suction pads are clean before attaching the service port adaptor to the transmitter.
- Avoid using the service port adaptor in direct sunlight as this can interfere with normal operation.

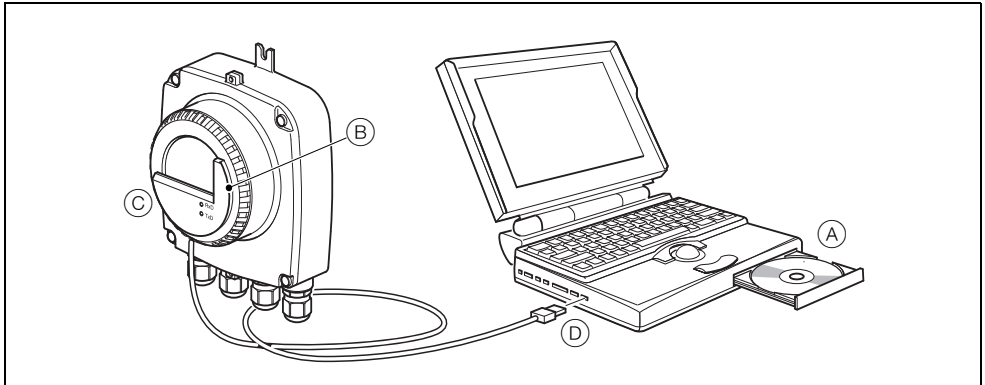

Fig. 8.1 Attaching the Service Port Adaptor to the Transmitter

To prepare the service port adaptor for use:

1. Install the Utility Software CD (A) onto the PC – see Section 8.2, page 49.
2. Carefully align the two infrared ports on the inside face of the adaptor (B) with the two infrared sensor channels on the transmitter glass display.
3. Secure the service port adaptor (C) to the transmitter glass area using the suction pads.
4. Connect the USB cable (D) to the USB port on the PC.

## 8.4 Configuring the Service Port Splitter

### 8.4.1 Configuration Overview

The Service Port Splitter can be configured to assign up to four virtual COM ports to individual client applications. Data can be transmitted to different virtual ports concurrently.

A typical virtual port configuration could contain the following settings:

- Client 1 – assigned to the remote HMI application.
- Client 2 – assigned a HART-compatible application.
- Client 3 – assigned to output cyclic data (to an Excel worksheet).
- Client 4 – assigned to output parameter data (to an Excel worksheet or a text file). The parameter data includes configuration settings.

Fig. 8.2 is a representation of a typical virtual port configuration (COM numbers are selected during configuration – see Section 8.4.2, page 52):

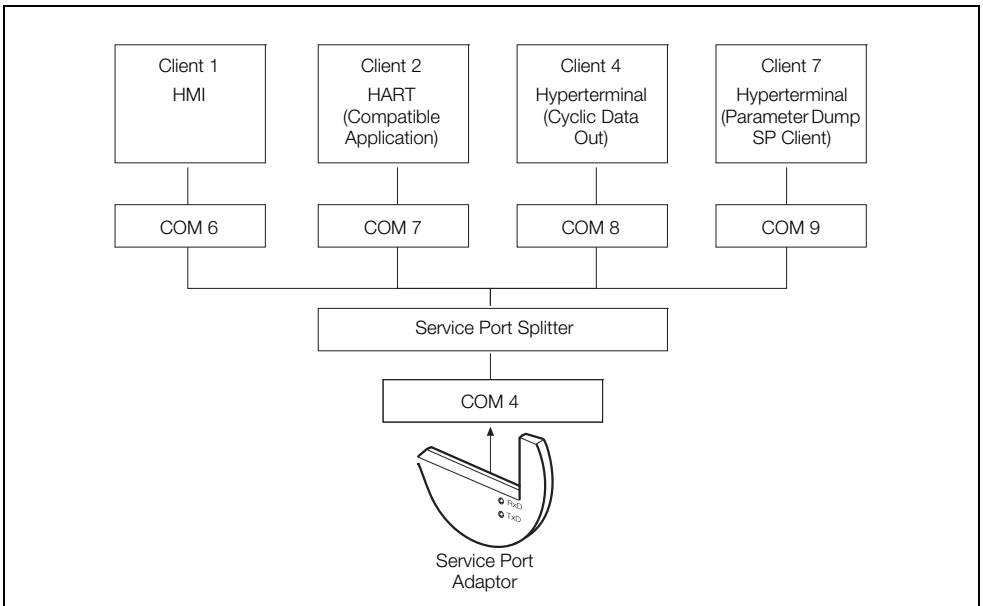
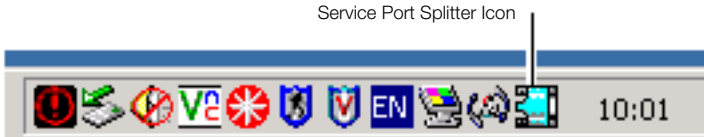

Fig. 8.2 Typical Service Port Splitter Configuration

### 8.4.2 COM Port and Client Configuration

To configure the COM ports and clients:

1. Connect the service port adaptor to the transmitter – see Section 8.3, page 50.
2. Launch the Service Port Splitter from the Windows 'Start' menu (Start\Programs\ABB\Service Port Splitter) or, if the service is already running, double-click the desktop tray icon:



3. The Service Port Splitter splash screen is displayed.

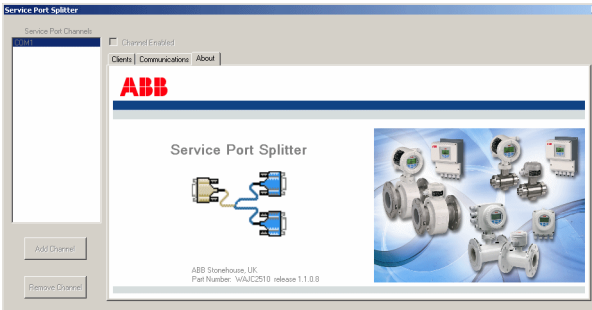

4. Click the 'Add Channel' button. The 'Set New Channel Port' dialog is displayed:

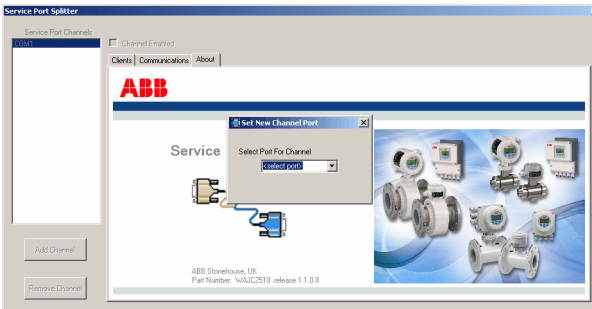

5. In the drop-down list, select a port number corresponding to the USB port of the plugged-in service port.
6. Click in the 'Channel Enabled' check box. The selected port number is displayed in the 'Service Port Channels' pane.

7. Click the 'Clients' tab. The 'Clients' pane is displayed:

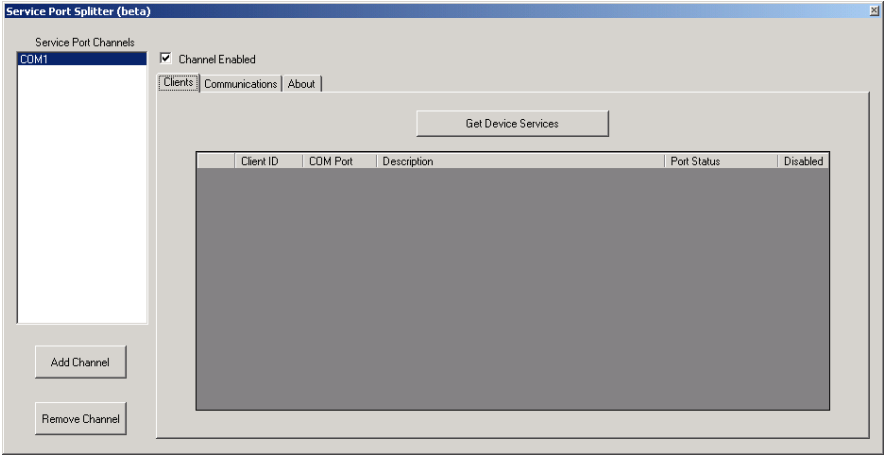

8. Click 'Get Device Services'. The 'Get Device Services' pane is populated with the available services:

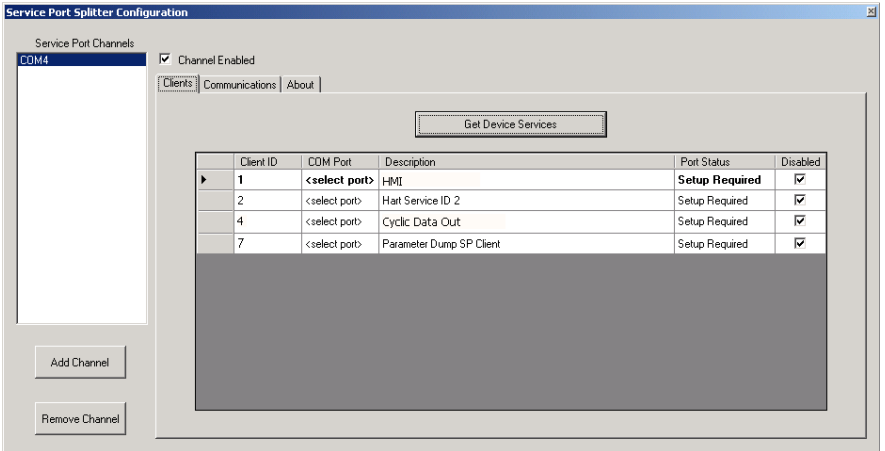

9. Position the cursor in the top row, 'Client ID' title field, select the title and right-mouse click to display the context menu.

10. Select 'Edit Client'.

11. The 'Edit Client' dialog is displayed:

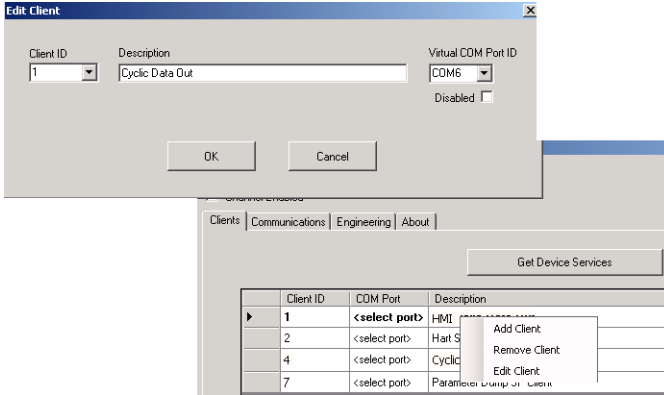

12. In the drop-down 'Virtual COM Port ID' field, select a free port number for this client.
13. Deselect the 'Disabled' check box.
14. Click 'OK' to display the modified client's configuration details in the 'Clients' pane.
15. Repeat steps 9 to 14 to configure each of the remaining virtual ports.

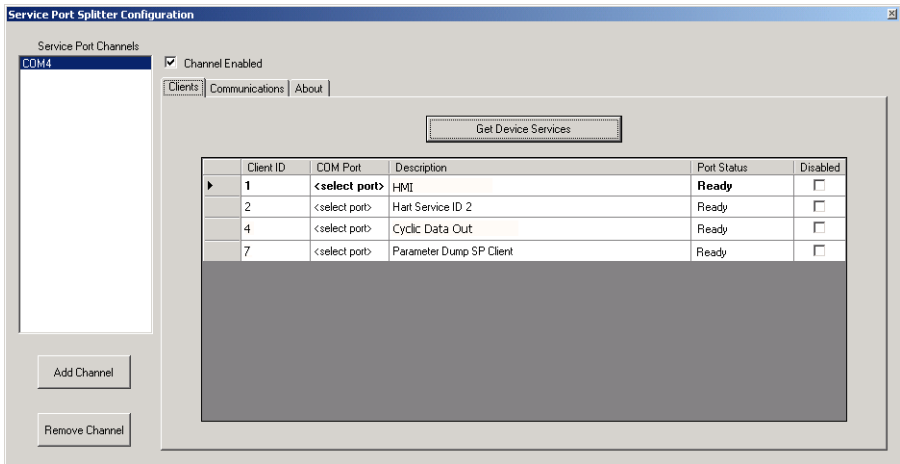



### 8.4.3 Stopping the Service

To stop the Service Port Splitter service:

1. Right-mouse click the Service Port Splitter tray icon. A context menu is displayed.

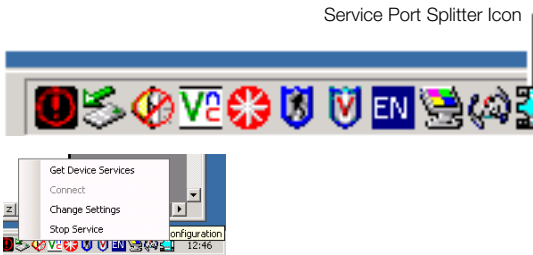

2. Select 'Stop Service'.
3. The driver exits and connection to the virtual ports is terminated.

### 8.4.4 Starting the Service

To (re)start the Service Port Splitter service:

1. From the Windows 'Start' menu select \Programs\ABB\Service Port Splitter.
2. The service is (re)started, the Service Port Splitter icon (re)appears in the tray and connection to the virtual ports is reinstated.

## 8.5 Cyclic Data Out

Cyclic data can be saved and output to a spreadsheet or as text. The update rate and data groups enabled for output are selected at the 'Communication'/'Cyclic Data Out'/'Cyclic Update Rate' and 'Cyclic Update Sel' parameters – see Section 5.2.6, page 27.

**Note.** Data output is limited to the access permissions available to the user at time of output.

To output cyclic data:

1. Launch a terminal application.
2. Configure the terminal application to communicate with the COM port previously specified for cyclic data output (COM port settings can be left as default settings).
3. To start the output routine, press 'P' on the PC keyboard (press 'S' to stop). A header row is created and enabled data groups are output at the rate set in the 'Communication'/'Cyclic Data Out'/'Cyclic Update Rate' parameter – see Section 5.2.6, page 27.

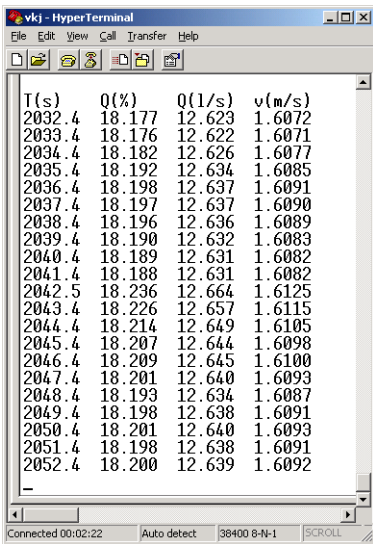

4. To output the data to a spreadsheet, use the capture capability to save a text (.txt) file and open it into Excel, selecting the file type as 'Delimited' at the Excel 'Text Import Wizard'. Data is then labelled and formatted automatically for display and analysis.

## 8.6 Parameter Dump

**Note.** Data output is limited to the access permissions available to the user at time of output.

The parameter dump option enables two types of information to be gathered:

- Configuration information
- Signals and Alarm information

To run a **Configuration** parameter dump:

1. Launch a terminal application.
2. Configure the terminal application to communicate with the COM port specified for the 'Parameter Dump SP Client'.
3. To start the output routine, press 'C' on the PC keyboard. Parameter data and configuration settings are displayed by the terminal application.
4. To output the data to a spreadsheet, capture the data as a text (.txt) file, open it into Excel and select the file type as 'Delimited' using a ';' delimiter at the Excel 'Text Import Wizard'.

To run a **Signals and Alarm** parameter dump:

1. Launch a terminal application.
2. Configure the terminal application to communicate with the COM port specified for the 'Parameter Dump SP Client'.
3. To start the output routine, press 'I' on the PC keyboard. A header row is created and parameter data and configuration settings are imported into Hyperterminal.
4. To output the data to a spreadsheet, capture the data as a text (.txt) file, open it into Excel and select the file type as 'Delimited' using a ';' delimiter at the Excel 'Text Import Wizard'.





## 8.7 Remote HMI

**Note.** The Remote HMI (Human-Machine Interface) application is included on the installation CD supplied.

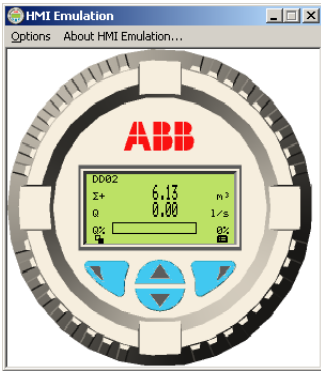
To install the Remote HMI application:

1. Launch the Remote HMI application from:  
*[DRIVE]\Programs\ABB\ABB HMI Emulation*



2. From the 'Options/Comms Ports' menu, select the COM number assigned in the Service Port Splitter to this client.
3. Click 'Save Settings'.
4. Operate the Remote HMI using the mouse and cursor to select the , ,  and  keys in the same way as operating the physical HMI.

## 8.8 HART Client

**Note.** Any standard HART application can be used via the infrared service port and ABB Service Port Splitter utility. All communications are handled automatically with no need for a HART modem. (HART client for WaterMaster's Service Port is available in all WaterMaster variants.)

To run the HART client:

1. Ensure the ABB Service Port Splitter is installed and running.
2. Ensure a COM port is assigned to the HART Application as detailed in Section 8.4.2, page 52.
3. Launch any preferred PC HART application, such as SMARTVision or similar.
4. Configure the COM port on the running HART application to be the COM port assigned in step 1 above.

The HART application operates as normal allowing any HART command to be read or written.

**Note.** An increase in operating speed may be noticed because HART communication transmits faster through the service port than through a normal HART modem.

## Notes

Key: Standard Access Advanced Access

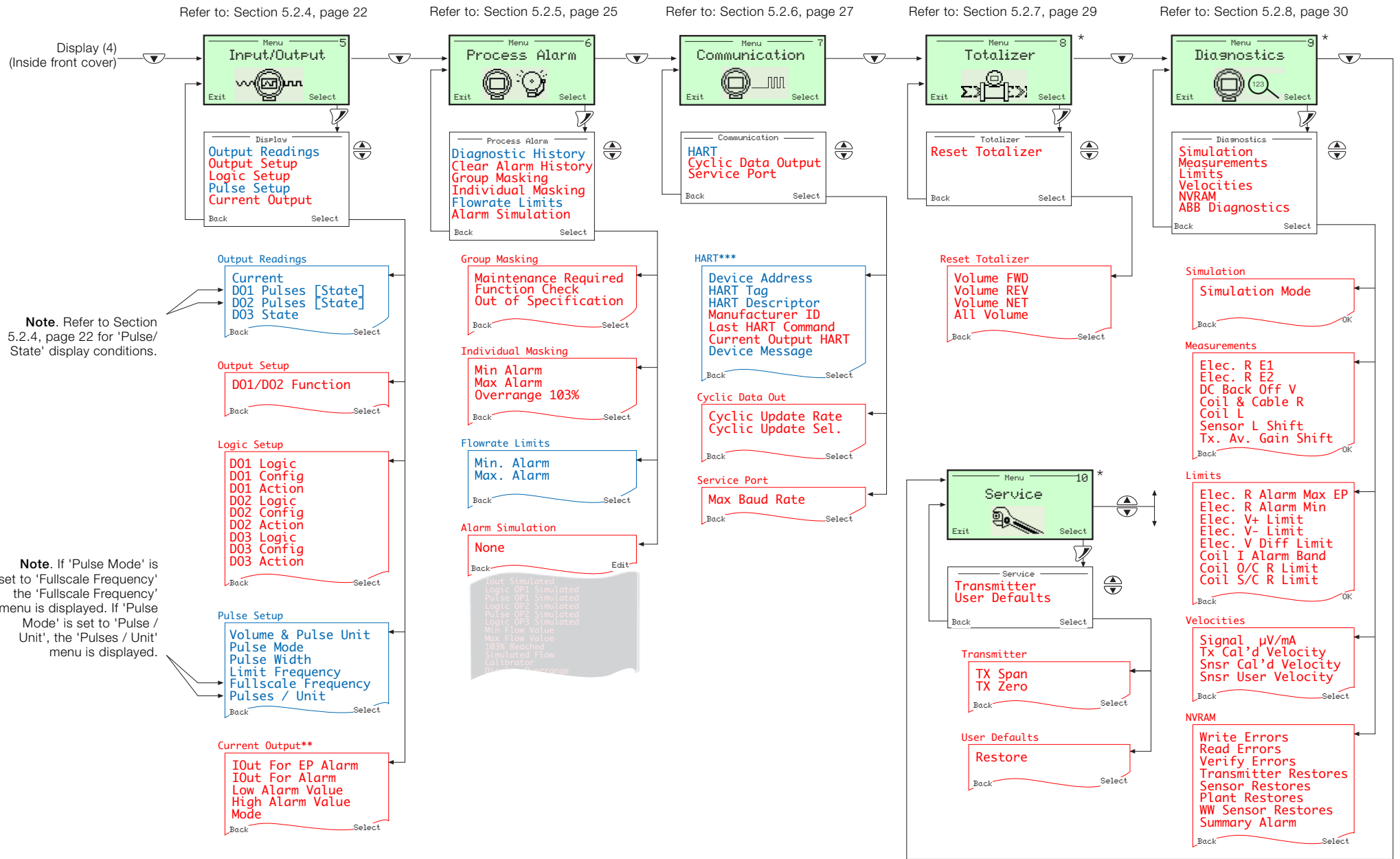

\* These screens are not displayed at 'Read Only' level.

\*\* The 'Current Output' menu is displayed on HART WaterMaster variants only.

\*\*\* The HART menu is displayed on all WaterMaster variants, but only affects HART via the Service Port if the WaterMaster does not have a HART transmitter. Other comms options (for example PROFIBUS) appear after the Service Port menu depending on the transmitter variant.

## Acknowledgments

Microsoft is a registered trademark of Microsoft Corporation in the United States and / or other countries.

Profibus and Profibus DP are registered trademarks of the Profibus Organization.

Modbus is a registered trademark of the Modbus-IDA organization.

HART is a registered trademark of the HART Communication Foundation.

---

**ABB Limited**  
**Measurement & Analytics**  
Oldends Lane, Stonehouse  
Gloucestershire  
GL10 3TA  
UK  
Tel: +44 (0)1453 826661  
Fax: +44 (0)1453 829671  
Email: instrumentation@gb.abb.com

**ABB Inc.**  
**Measurement & Analytics**  
125 E. County Line Road  
Warminster  
PA 18974  
USA  
Tel: +1 215 674 6000  
Fax: +1 215 674 7183

**ABB Engineering (Shanghai) Ltd.**  
**Measurement & Analytics**  
No. 4528, Kangxin Highway  
Pudong New District  
201319, Shanghai  
P.R. China  
Tel: +86 (0) 21 6105 6666  
Fax: +86 (0) 21 6105 6677

**[abb.com/measurement](http://abb.com/measurement)**

---

We reserve the right to make technical changes or modify the contents of this document without prior notice. With regard to purchase orders, the agreed particulars shall prevail. ABB does not accept any responsibility whatsoever for potential errors or possible lack of information in this document.

We reserve all rights in this document and in the subject matter and illustrations contained therein. Any reproduction, disclosure to third parties or utilization of its contents – in whole or in parts – is forbidden without prior written consent of ABB.  
© ABB 2018

Sales Service Software

