

MT5000 Series

Guided wave radar level transmitter

High accuracy
level and interface detection
for liquids, slurries and solids
K-TEK Products



Features

- SIL 2/3 Certified IEC 61508*
- Graphic Display with Waveform Screen
- Widest Selection of Wetted Materials
- Radar Signal Travels Along the Waveguide – Eliminates False Echoes and Minimizes Signal Loss
- No Moving Parts
- Rigid, Flexible Cable & Coaxial Probes
- All Digital Electronics
- Loop Powered to 217ft Probe Length
- Total and/or Interface Level Measurement
- Field Replaceable / Upgradable Electronics Module

Options

- FOUNDATION fieldbus output
- Glass viewing window
- 316 Stainless Steel enclosure
- Remote sensor

Accessories

- External chambers
- Stilling wells
- JDF200 loop indicator
- RI100 Repeat Indicator for 2 4-20mA Output Signals

* transmitters equipped with 4-20mA/HART module option only

Specifications for MT5000, MT5100 and MT5200 Transmitters

Electronic transmitter:

Resolution	+/- 0.063in. /1.6mm
Repeatability	0.1 in. / 3 mm
Ambient Temperature	-40 to 151°F (-40 to 66°C)
Measuring accuracy, level	Coax Probe or in stilling well/chamber +/- 3mm
	Single cable or rod +/-5mm to 15.24m (50.0ft)/ +/-25mm to 66m (217ft)
Measuring accuracy, interface level and ULD mode	All probes +/-1.0in / 25mm
Supply voltage	13.5 to 36 Vdc - 4-20mA HART loop powered
	9 to 32 Vdc - FOUNDATION fieldbus
Output/Communications	4-20 mA HART - SIL 2/3 Certified IEC 61508
	FOUNDATION fieldbus - ITK 5.1.0 Compliant - 5 AI and 1 PID blocks - 15.8 mA quiescent current draw - LAS Capable
Power consumption	4-20mA at 36.0 Vdc - 3.6mA 0.13 watts; 21mA 0.76 watts at 13.5 Vdc - 3.6mA 0.046 watts; 21mA 0.28 watts
	HART mode (4.0mA) at 36.0 Vdc 0.144 watts at 13.5 Vdc 0.054 watts
	FOUNDATION fieldbus 0.5 watts maximum
Maximum line resistance	4-20mA at 36.0 Vdc and 21mA, 1740 ohms* *maximum with HART communication is 700 ohms at 13.5 Vdc and 21mA, 645 ohms
	HART mode (4.0mA) < 650 to 700 ohms
	FOUNDATION fieldbus 43.6 ohms/km @ 20 C
Reverse polarity protection	Diode in series with loop
Update rate	2 outputs per second
Damping	Field adjustable, range: 0.1 to 36 seconds
Alarm output	NE43, Jumper selectable upscale (21 mA) or downscale (3.6 mA)
Humidity	0 to 100% RH, non-condensing
Linearization	20 point linearization table available
Graphic Display	Field Selectable Units in Feet, Inches, Millimeters, Centimeters, Meters or Percentage and Waveform Screens
Enclosure	Dual compartment
Enclosure material	Cast low copper aluminum with polyester powder coat or 316 stainless steel
Electrical connection	1/2" FNPT, M20 adapter and bus connectors available
Ingress protection	IP66, NEMA 4X

¹ see approval agency restrictions

Specifications

Sensor

	Standard	Options
Material	316/L stainless steel	304/L, Hastelloy C-276, Hastelloy B3, Monel 400, Titanium, Inconel625, other materials on request
Process temperature	-60 to 400°F (-50 to 204°C), see o-ring selection	up to 800°F (427°C) with options
Process pressure	-14.5 to 1500psig @ 300°F (103 bar @ 38°C)	-14.5 to 5000 psig (0 to 344barg)
Range	2 to 217 ft. / 0.6 to 66.14 m	
Process Connection	3/4" NPT Standard, other threaded and flanged options available	
Dielectric Constant	Minimum 1.4, 1.3 in ULD mode	
Process Viscosity	coax 500 cp, single probe 10,000 cp	

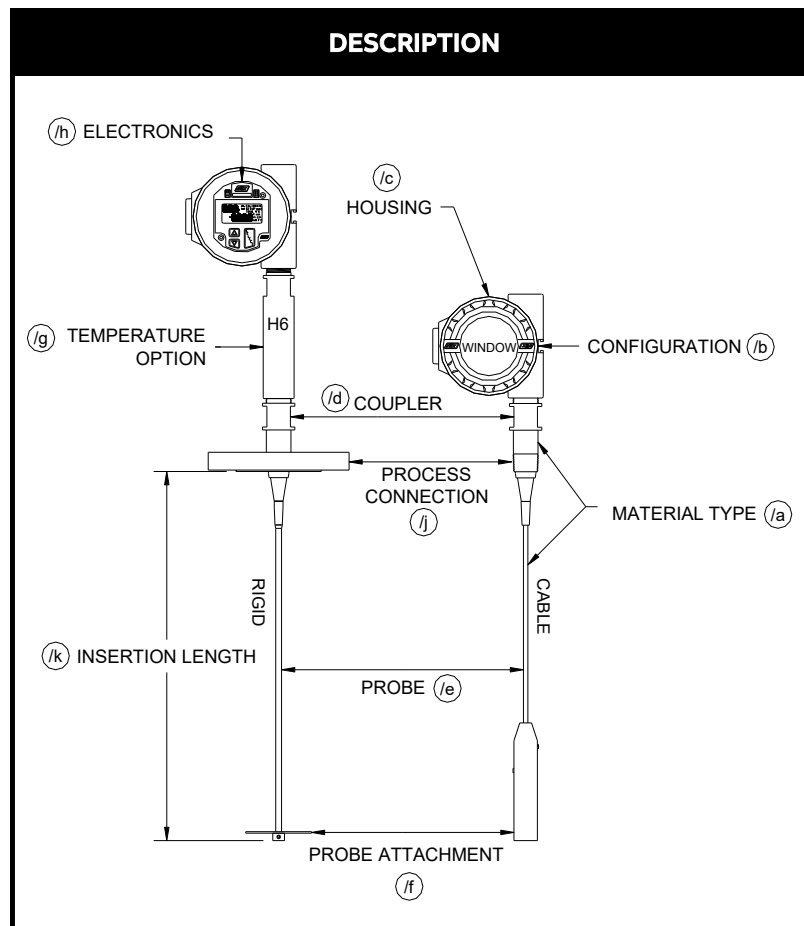

MT5100 INTERFACE GUIDELINES

In order to properly detect the level of interface between two liquids using the MT5100, the following rules must be adhered to:

1. One of the following probe and mounting configurations must be used:
 - a. Single rigid rod or flexible cable mounted in a stilling well, external chamber, or existing displacer.*
 - b. Coaxial probe mounted into tank, external chamber, or displacer
 - c. Single rigid rod or flexible cable in open vessel with recommended installation conditions.
**This is the preferred mounting configuration to reduce the chance of fouling.*
2. Emulsion layers will affect the detection of an interface level. An emulsion layer may negate an interface level indication completely. The MT5100 will read an interface level in the presence of a 3 inch emulsion. Greater emulsion layers may be possible. Please consult factory.
3. The minimum upper fluid thickness must be 4 inches when emulsion is present, and 3 inches with a clean interface. Closer measurement may be possible with calibration adjustment.
4. The upper fluid dielectric constant must be greater than 1.4 and less than 5.
5. The interface level indication is a calculated value based partially upon the dielectric of the upper fluid. The upper fluid dielectric must remain constant for consistency / accuracy in the interface level indication.
6. The lower fluid dielectric constant must not be less than 15.
7. If the application is a flooded condition (sensor completely submerged in process), it must remain completely flooded.
8. In a non-flooded condition, the upper fluid must not be allowed to enter the upper unmeasurable zone. The upper unmeasurable zone is typically located within the mounting nozzle of the vessel.
9. If measuring interface in an external chamber, ensure that the fluid is allowed to equalize between the vessel and the chamber. Consult the factory or your local representative for assistance.
10. R and RW remote coupler configurations are not recommended for interface applications unless the remote coax is 5ft or less and the probe is a coaxial configuration or in a chamber or stilling well.

If the required interface application does not fall within the above mentioned parameters, please consult the factory for an alternate technology, such as an LMT Series magnetostrictive transmitter or a KM26 magnetic level gauge.

GUIDELINES FOR MEASURING with ULD MODE

When measuring low dielectric fluids and bulk solids, it is possible to use the end of probe shift as the target. Requirements for using the end of probe in Ultra Low Dielectric (ULD) mode.

1. The dielectric of the material must be between 1.3 and 3.0.
2. You must have a clear end of probe signal. This may require an additional disk on the end of probe in order to increase the reflection.
3. The probe type can be cable, rod, or coaxial.
4. Accuracy may be affected if dielectric value changes.
5. If the end of probe is lost in sludge, interface or emulsion, and the end of probe signal is lost, then ULD reading will not be possible.
6. ULD mode cannot be used where interface or emulsion layer are present.

PROCESS CONNECTION / WAVEGUIDE COUPLER

Base Code	Insulator	Process Connection	Seal Options	Maximum Pressure	Min Temp ⁵	Max Temp ⁵	Compatible Probes		
							Rod	Cable	Coaxial
C1¹	Teflon	3/4" NPT	Viton FKM A, Kalrez 4079	1500 psi @ 100°F / 103 bar @ 38°C	-60°F -50°C	400°F 204°C	P01, P03,	P11	P51, P91 ⁷
C2¹		1.5" NPT		EPDM,			600 psi @ 400°F / 41 bar @ 204°C	P02, P43	P12, P33
C3¹		2.5" NPT	Markez Z1319	50 psi / 13.4 bar			P12, P33, P61		
C1H¹	Teflon	3/4" NPT	Viton FKM A, Kalrez 4079	3000 psi @ 100 F / 207 bar @ 38 C	-60°F -50°C	400°F 204°C	P01, P03	P11,	P51, P91 ³
C2H¹		1.5" NPT		EPDM, Markez Z1319			1200 psi @ 400 F / 83 bar @ 204 C	P02, P43	P12, P33,
C8 <small>(316/L SS and Hastelloy C only)</small>	Borosili- cate Glass	1.5" NPT	Fused Borosilicate Glass	5000 psi @ 100°F / 344 bar @ 38°C	-60°F -50°C	800°F 427°C		P11 ⁴	P71
							1500 psi @ 800°F / 103 bar @ 427°C	Not for Hot Water or Steam Service	
C9²	Alumina Ceramic	1" NPT	Viton FKM A, Kalrez 4079 EPDM, Markez Z1319	2000 psi @ 635°F / 138 bar @ 335°C	-60°F -50°C	635°F 335°C		P11 ⁴	P81
CZ	Custom (Consult Factory)								

- Notes:**
1. Add the suffix "S" to the Base Code to include a hermetic seal (example: /C4SV). Hermetic seals are required on all IECEx approved equipment.
 2. Hermetic seal is required. O-ring selection Markez 1319 is recommended for steam service.
 3. The P91 probe has a 1" MNPT adjustable compression fitting equipped with Teflon ferrules as the standard process connection. The maximum process pressure utilizing the Teflon ferrules is 50 psi (3.4 bars).
 4. Requires installation in a stilling well or external chamber.
 5. Consult O-ring Table for o-ring temperature specifications.

O-Ring Seals*

Order Code	Description	Min. Temp	Max. Temp
V	Viton A (FKM)	-15°F -26°C	400°F 204°C
K	Kalrez 4079	-40°F -40°C	400°F 204°C
E	EPDM	-60°F -50°C	250°F 125°C
A	Markez Z1319	-14°F -10°C	572°F 300°C

*The information in this chart has been supplied by the o-ring manufacturers. Before permanent installation, test the equipment with the chemicals and under the specific conditions of your application.

If the required o-ring material is not listed above, please consult the factory.

Pressure / Temperature Curves¹

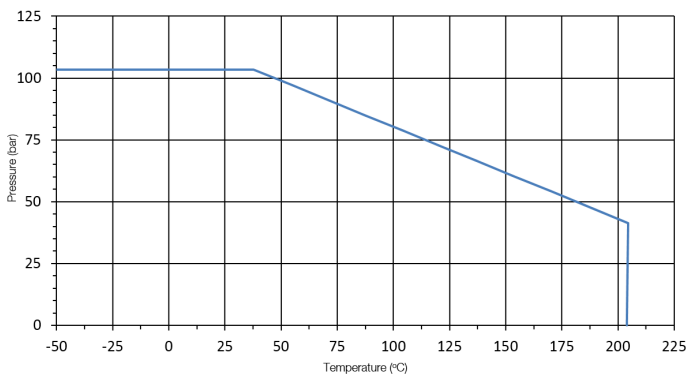

Pressure versus Temperature for C1 and C2 Couplers

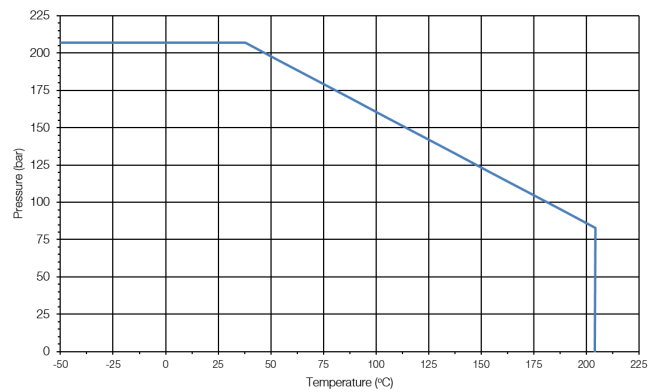

Pressure versus Temperature for C1H and C2H Couplers

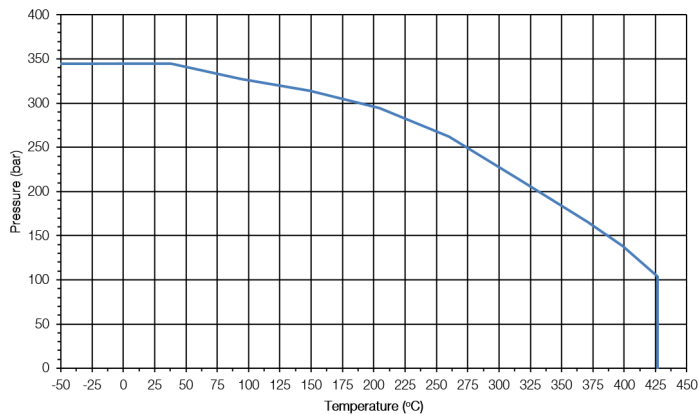

Pressure versus Temperature for C8 Couplers

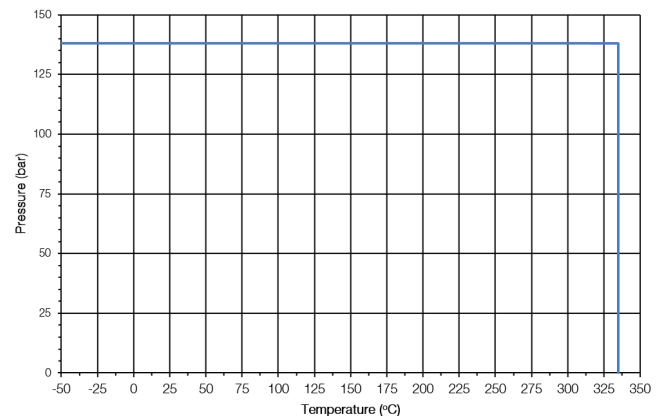

Pressure versus Temperature for C9 Couplers²

1. Coupler temperatures are based on o-ring temperature ratings. Please refer to the o-ring chart above for further information.

2. C9 coupler temperature rating is based on Markez Z1319 o-ring selection. The temperature is based on o-ring placement inside the coupler, thus allowing higher temperatures at the process connection.

Probe Types

Code	O.D	Notes	Max Length	Attachment Options
Rigid Rod				
P01	0.25in (6mm)		20ft (3.05m) ^{1,3}	D
P02	0.50in (13mm)		20ft (6.10m) ^{2,3,4}	
P03	0.375in (9mm)		10ft (3.05m) ^{1,3}	
P43	0.125in (3mm)	316 SS and HSC-270	50ft (15.24m)	W (included)
Flexible Cable				
P11	0.1875in (5mm)	2,000lb (907kg) maximum pull force	100ft (30.5m) ³	W, E, WD
P12	0.25in (6mm)	2,000lb (907kg) maximum pull force		
P61	0.31in (8mm)	10,000lb (4536kg) maximum pull force		
Triangle Cable				
P33	0.25in (6mm)	Minimum 4" flange connection required	100ft (30.5m)	WS6 (included)
Coaxial (clean liquids only)				
P51	0.875in (22mm)		22ft (6.71m)	none
P71	1.315in (34mm)	316SS only		
P81	0.875in (22mm)	316SS only		
P91	1.00in (25mm)			
CUSTOM				
PZZ	Custom Probe, Consult Factory			

- Notes:
- 1.5ft (1.52m) maximum probe length when installed in a stilling well or EC chamber (minimum 2" diameter) without centering spacer(s).
 2. 20ft (3.05m) maximum probe length when installed in a stilling well or EC chamber (minimum 3" diameter) without centering spacer(s).
 3. Lengths greater than 7ft (2.13m) require cable spacers at 5ft (1.52m) maximum intervals when installed in a 2" or smaller stilling well or EC chamber. Lengths greater than 10ft (3.05m) require cable spacers at 10ft (3.05m) maximum intervals when installed in 2.5" - 3" stilling well or EC chamber.
 4. Segmented probes available

Cable weights for cable probes

Order Code	O.D.	Weight Height (WH)	Weight	Minimum Stilling Well Size	Compatible Probes
W09	0.875 in. (22.2 mm)	4.0 in. (101.6 mm)	0.7 lbs (301 g)	1.0 in. Sch. 80	P11
W10	1.0 in. (25.4 mm)	6.0 in. (152.4 mm)	1.3 lbs (590 g)	1.5 in. Sch. 160	P11, P12
W13	1.25 in. (31.75 mm)	3.5 in. (88.90 mm)	0.8 lbs (317 g)	1.5 in. Sch. 80	P11, P12
W16	1.625 in. (41.3 mm)	2.0 in. (50.8 mm)	1.1 lbs (499 g)	2.0 in. Sch. 80	P11
W19	1.875 in. (47.6 mm)	2.0 in. (50.8 mm)	1.5 lbs (680 g)	2.0 in. Sch. 80	P12
W29	2.875 in. (73.3 mm)	1.0 in. (25.4 mm)	1.8 lbs (816 g)	3.0 in. Sch. 40	P11, P12
W61	1.5 in. (38.1 mm)	5.25 in. (133.35 mm)	2.2 lbs (998 g)	n/a	P61
WS6	2.0 in. (50.8 mm)	6.0 in. (152.4 mm) long	0.9 lbs / 408 g	n/a	P33

Centering disks for rod probes

Order Code	O.D.	Minimum Stilling Well Size
D15	1.5 in. (38.1 mm)	1.5 in. sch. 40
D20	2.0 in. (50.8 mm)	2 in. sch. 40
D23	2.3 in. (58.7 mm)	2.5 in. sch. 40
D28	2.8 in. (71.1 mm)	3 in. sch. 80
D38	3.75 in. (95.3 mm)	4 in. sch. 80

MT5000 Recommended Installation

NOTE: The following guidelines are very conservative. If you have an application that exceeds these limits consult factory for application recommendations.

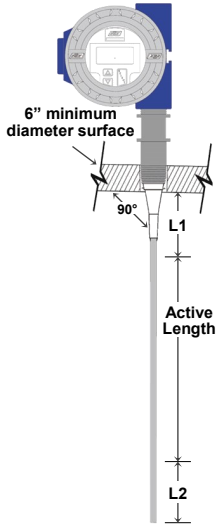

1. SINGLE PROBE - FLAT PLATE

MINIMUM DIELECTRIC CONSTANT	L MAXIMUM PROBE LENGTH ²	L1 Unmeasurable ¹	L2 Unmeasurable ¹ (WH = Weight Height)
≤4	20 ft. / 6.1 m	6 in. / 15.2 cm	3 in. / 7.6 cm (Rod) WH + 3 in. / 7.6 cm (cable)
10	40 ft. / 12.2 m	3 in. / 7.6 cm	2 ¹ (Rod) WH + 3" / 7.6 cm (cable)
35	50 ft. / 15.2 m	3 ¹ in. / 7.6 cm	

- Depending on installation, L1 & L2 unmeasurable lengths of 0 may be possible with use of linearization table and latching feature. For easiest startup use $L1_{min} \geq 3"$ or as listed if greater and $L2_{min} \geq 3"$ (rod) or $WH + 3"$ (cable).
- Maximum probe lengths are limited as indicated in Probe Type table.

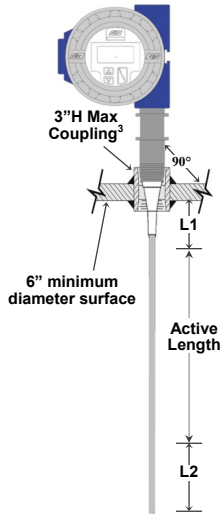

2. SINGLE PROBE - FLAT PLATE WITH COUPLING³

MINIMUM DIELECTRIC CONSTANT	L MAXIMUM PROBE LENGTH ²	L1 Unmeasurable ¹	L2 Unmeasurable ¹ (WH = Weight Height)
≤4	20 ft. / 6.1 m	8 in. / 20.3 cm	3 in. / 7.6 cm (Rod) WH + 3 in. / 7.5 cm (Cable)
10	40 ft. / 12.2 m	4 in. / 10.2 cm	2 ¹ (Rod) WH + 3 in. / 7.5 cm (Cable)
35	50 ft. / 15.2 m	3 in. / 7.6 cm	

- Depending on installation, L1 & L2 unmeasurable lengths of 0 may be possible with use of linearization table and latching feature. For easiest startup use $L1_{min} \geq 3"$ or as listed if greater and $L2_{min} \geq 3"$ (rod) or $WH + 3"$ (cable).
- Maximum probe lengths are limited as indicated in Probe Type table.
- The coupling should not extend into the vessel more than 1 in. / 2.5 cm.

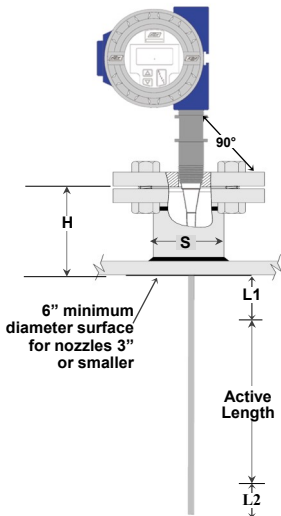

3A. SINGLE PROBE - NOZZLE & FLANGE³

MINIMUM DIELECTRIC CONSTANT	L MAXIMUM PROBE LENGTH ²	L1 Unmeasurable ¹	L2 Unmeasurable ¹ (WH = Weight Height)
≤4	20 ft. / 6.1 m	H + 8 in. / 20.3 cm	3 in. / 7.6 cm (Rod) WH + 3 in. / 7.5 cm (Cable)
10	40 ft. / 12.2 m	H + 4 in. / 10.2 cm	2 ¹ (Rod) WH + 3 in. / 7.5 cm (Cable)
35	50 ft. / 15.2 m	H + 2 ¹ in. / 5.1 ¹ cm	

- Depending on installation, L1 & L2 unmeasurable lengths of 0 may be possible with use of linearization table and latching feature. For easiest startup use $L1_{min} \geq 3"$ or as listed if greater and $L2_{min} \geq 3"$ (rod) or $WH + 3"$ (cable).
- Maximum probe lengths are limited as indicated in Probe Type table.
- A one time startup adjustment is required to eliminate the effect of the nozzle. For details refer to the Blanking Parameter in the Commissioning section of the Installation & Operation Manual.

MT5000 Recommended Installation

NOTE: The following guidelines are very conservative. If you have an application that exceeds these limits consult factory for application recommendations.

3B. SINGLE PROBE - NOZZLE & FLANGE³ [height of nozzle (H) less than width of nozzle (S)]

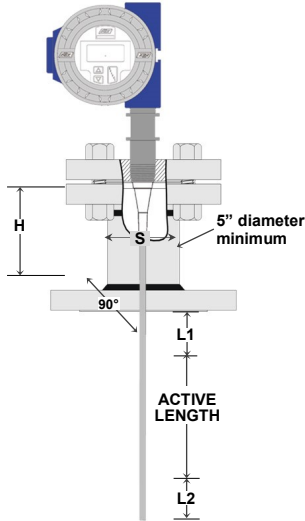

MINIMUM DIELECTRIC CONSTANT	L MAXIMUM PROBE LENGTH ²	L1 Unmeasurable ¹	L2 Unmeasurable ¹ (WH = Weight Height)
≤ 4	20 ft. / 6.1 m	H + 6 in. / 15.24 cm	3 in. / 7.6 cm (Rod) WH + 3 in. / 7.6 cm (Cable)
10	40 ft. / 12.2 m	H + 3 in. / 7.6 cm	2 ¹ (Rod) WH + 3 in. / 7.6 cm (Cable)
35	50 ft. / 15.2 m	H + 3 ¹ in. / 7.6 ¹ cm	

1. Depending on installation, L1 & L2 unmeasurable lengths of 0 may be possible with use of linearization table and latching feature. For easiest startup use $L1_{min} \geq 3''$ or as listed if greater and $L2_{min} \geq 3''$ (rod) or $WH + 3''$ (cable).
2. Maximum probe lengths are limited as indicated in Probe Type table.
3. A one time startup adjustment is required to eliminate the effect of the nozzle. For details refer to the Blanking Parameter in the Commissioning section of the Installation & Operation Manual.

4. SINGLE PROBE - PERMANENT STILLING WELL

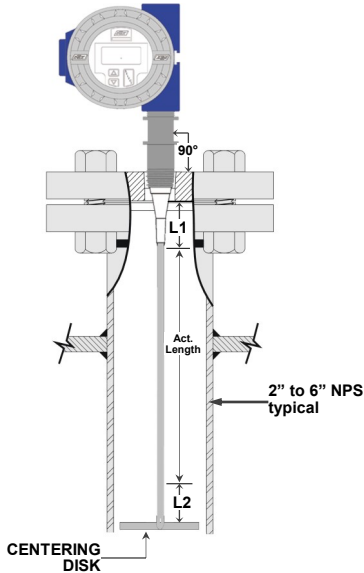

MINIMUM DIELECTRIC CONSTANT	L MAXIMUM PROBE LENGTH ²	L1 Unmeasurable ¹	L2 Unmeasurable ¹ (WH = Weight Height)
≤ 1.7 ³	20 ft. / 6.1 m	8 in. / 20.3 cm	3 in. / 7.6 cm (Rod) WH + 3 in. / 7.6 cm (Cable)
3	30 ft. / 9.1 m	6 in. / 15.2 cm	
10	50 ft. / 15.2 m	3 in. / 7.6 cm	2 ¹ (Rod) WH + 3 in. / 7.6 cm (Cable)
35	217 ft. / 66.1 m		

1. Depending on installation, L1 & L2 unmeasurable lengths of 0 may be possible with use of linearization table and latching feature. For easiest startup use $L1_{min} \geq 3''$ or as listed if greater and $L2_{min} \geq 3''$ (rod) or $WH + 3''$ (cable).
2. Maximum probe lengths are limited as indicated in Probe Type table.
3. Stilling well size will determine minimum dielectric constant. ULD mode can be used for longer lengths up to 50 ft (15.2 m).

5. SINGLE PROBE - REMOVABLE STILLING WELL

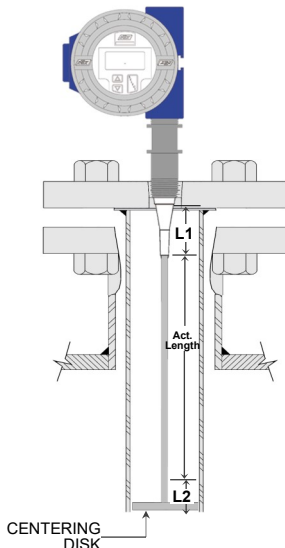

MINIMUM DIELECTRIC CONSTANT	L MAXIMUM PROBE LENGTH ²	L1 Unmeasurable ¹	L2 Unmeasurable ¹ (WH = Weight Height)
≤ 1.7 ³	20 ft. / 6.1 m	8 in. / 20.3 cm	3 in. / 7.6 cm (Rod) WH + 3 in. / 7.6 cm (Cable)
3	30 ft. / 9.1 m	6 in. / 15.2 cm	
10	50 ft. / 15.2 m	3 in. / 7.6 cm	2 ¹ (Rod) WH + 3 in. / 7.6 cm (Cable)
35	217 ft. / 66.1 m		

1. Depending on installation, L1 & L2 unmeasurable lengths of 0 may be possible with use of linearization table and latching feature. For easiest startup use $L1_{min} \geq 3''$ or as listed if greater and $L2_{min} \geq 3''$ (rod) or $WH + 3''$ (cable).
2. Maximum probe lengths are limited as indicated in Probe Type table.
3. Stilling well size will determine minimum dielectric constant.

MT5000 Recommended Installation

NOTE: The following guidelines are very conservative. If you have an application that exceeds these limits consult factory for

6. SINGLE PROBE - EXTERNAL CHAMBER

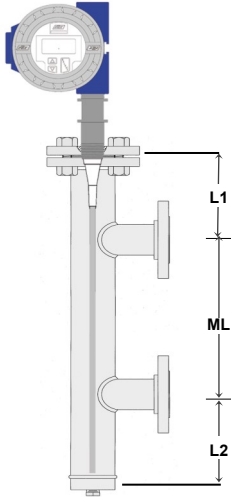

MINIMUM DIELECTRIC CONSTANT	L MAXIMUM PROBE LENGTH ²	L1 Unmeasurable ¹	L2 Unmeasurable ¹ (WH = Weight Height)
$\leq 1.7^3$	20 ft. / 6.1 m	9 in. / 22.86 cm	3 in. / 7.6 cm (Rod) WH + 3 in. / 7.6 cm (Cable)
3	30 ft. / 9.1 m	6 in. / 15.2 cm	
10	50 ft. / 15.2 m	3 in. / 7.5 cm	
35	217 ft. / 66.1 m		

- Depending on installation, L1 & L2 unmeasurable lengths of 0 may be possible with use of linearization table and latching feature. For easiest startup use $L1_{min} \geq 3"$ or as listed if greater and $L2_{min} \geq 3"$ (rod) or $WH + 3"$ (cable).
- Maximum probe lengths are limited as indicated in Probe Type table.
- Stilling well size will determine minimum dielectric constant. ULD mode can be used for longer lengths up to 50ft (15.2m).

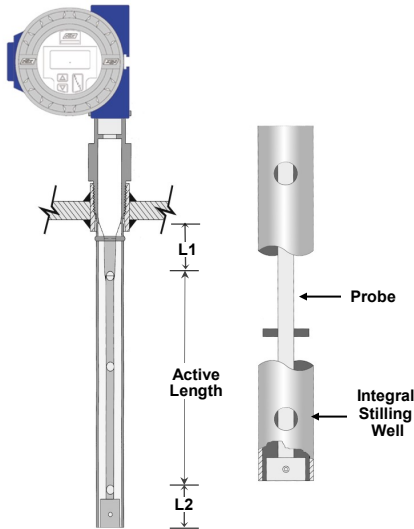

7. COAXIAL PROBE (rod inside of outer tube) clean liquids only]

MINIMUM DIELECTRIC CONSTANT	L MAXIMUM PROBE LENGTH ²	L1 Unmeasurable ¹	L2 Unmeasurable ¹
1.4	22 ft. / 6.7 m	4 in. / 10.2 cm	2 in. / 5 cm
2.0		2 in. / 5.1 cm	
4.0			

- Depending on installation, L1 & L2 unmeasurable lengths of 0 may be possible with use of linearization table and latching feature. For easiest startup use $L1_{min} \geq 3"$ or as listed if greater and $L2_{min} \geq 3"$ (rod) or $WH + 3"$ (cable).
- Maximum probe lengths are limited as indicated in Probe Type table.
- Typically used in low dielectric, clean liquids.

MT5100 Recommended Installation

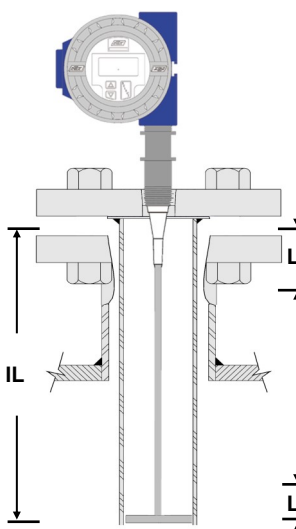
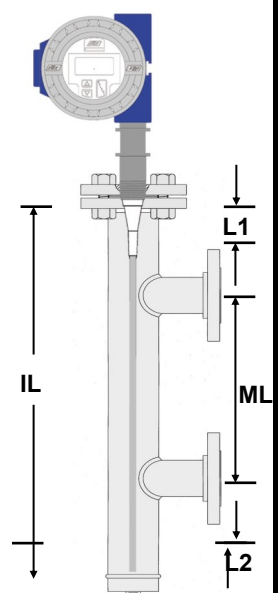
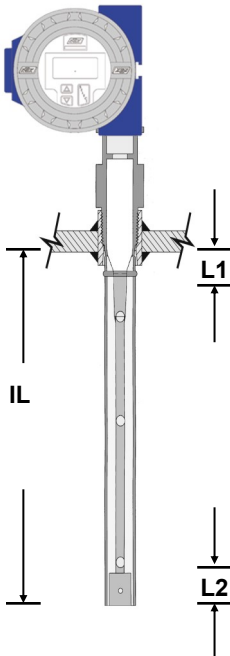
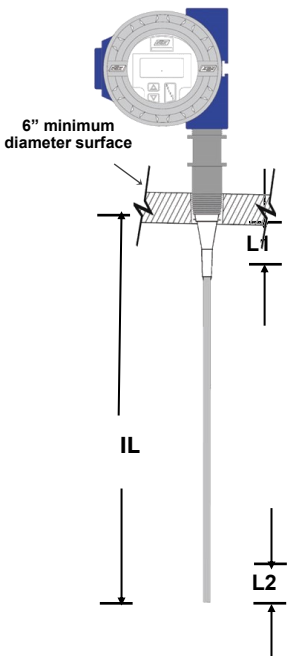
Cable or Rod - Stilling Well		Cable or Rod - External Chamber																					
<table border="1" style="width: 100%; border-collapse: collapse;"> <tr> <th colspan="2" style="text-align: center; padding: 5px;">UNMEASURABLE ZONES</th> </tr> <tr> <td style="width: 15%; padding: 5px;">L1</td> <td style="padding: 5px;">4 IN.</td> </tr> <tr> <td style="padding: 5px;">L2</td> <td style="padding: 5px;">3 IN. (+ weight height for P11, P12)</td> </tr> <tr> <th colspan="2" style="text-align: center; padding: 5px;">PROBE TYPES</th> </tr> <tr> <td colspan="2" style="padding: 5px;">P01, P02, P03, P11, P12, P43</td> </tr> </table>	UNMEASURABLE ZONES		L1	4 IN.	L2	3 IN. (+ weight height for P11, P12)	PROBE TYPES		P01, P02, P03, P11, P12, P43			<table border="1" style="width: 100%; border-collapse: collapse;"> <tr> <th colspan="2" style="text-align: center; padding: 5px;">UNMEASURABLE ZONES</th> </tr> <tr> <td style="width: 15%; padding: 5px;">L1</td> <td style="padding: 5px;">4 IN.</td> </tr> <tr> <td style="padding: 5px;">L2</td> <td style="padding: 5px;">3 IN. (+ weight height for P11 and P12)</td> </tr> <tr> <th colspan="2" style="text-align: center; padding: 5px;">PROBE TYPES</th> </tr> <tr> <td colspan="2" style="padding: 5px;">P01, P02, P03, P11, P12</td> </tr> </table>	UNMEASURABLE ZONES		L1	4 IN.	L2	3 IN. (+ weight height for P11 and P12)	PROBE TYPES		P01, P02, P03, P11, P12		
UNMEASURABLE ZONES																							
L1	4 IN.																						
L2	3 IN. (+ weight height for P11, P12)																						
PROBE TYPES																							
P01, P02, P03, P11, P12, P43																							
UNMEASURABLE ZONES																							
L1	4 IN.																						
L2	3 IN. (+ weight height for P11 and P12)																						
PROBE TYPES																							
P01, P02, P03, P11, P12																							
<ul style="list-style-type: none"> • Preferred Configuration 		<ul style="list-style-type: none"> • Preferred Configuration • Flooded or Non-Flooded 																					
<p>Note: Stilling Well Size 2" - 4" Pipe; Customer or K-TEK Supplied.</p>		<p>Note: Chamber Size 2" - 4" Pipe; Customer or K-TEK Supplied. Reference EC Data Sheet (EC100-0202-1) to specify /order external chamber available online at www.ABB.com on the Displacer Replacer and External Chamber page. End of probe or top of weight should extend a minimum of 2" (50mm) below lower process connection of chamber.</p>																					
Coaxial		Cable or Rod - Open Vessel																					
<table border="1" style="width: 100%; border-collapse: collapse;"> <tr> <th colspan="2" style="text-align: center; padding: 5px;">UNMEASUREABLE ZONES</th> </tr> <tr> <td style="width: 15%; padding: 5px;">L1</td> <td style="padding: 5px;">4 IN.*</td> </tr> <tr> <td style="padding: 5px;">L2</td> <td style="padding: 5px;">3 IN.</td> </tr> <tr> <th colspan="2" style="text-align: center; padding: 5px;">PROBE TYPES</th> </tr> <tr> <td colspan="2" style="padding: 5px;">P51, P71, P91</td> </tr> </table>	UNMEASUREABLE ZONES		L1	4 IN.*	L2	3 IN.	PROBE TYPES		P51, P71, P91			<table border="1" style="width: 100%; border-collapse: collapse;"> <tr> <th colspan="2" style="text-align: center; padding: 5px;">UNMEASURABLE ZONES</th> </tr> <tr> <td style="width: 15%; padding: 5px;">L1</td> <td style="padding: 5px;">4 IN.</td> </tr> <tr> <td style="padding: 5px;">L2</td> <td style="padding: 5px;">3 IN. (+ weight height for P11 and P12)</td> </tr> <tr> <th colspan="2" style="text-align: center; padding: 5px;">PROBE TYPES</th> </tr> <tr> <td colspan="2" style="padding: 5px;">P01, P02, P03, P11, P12</td> </tr> </table>	UNMEASURABLE ZONES		L1	4 IN.	L2	3 IN. (+ weight height for P11 and P12)	PROBE TYPES		P01, P02, P03, P11, P12		
UNMEASUREABLE ZONES																							
L1	4 IN.*																						
L2	3 IN.																						
PROBE TYPES																							
P51, P71, P91																							
UNMEASURABLE ZONES																							
L1	4 IN.																						
L2	3 IN. (+ weight height for P11 and P12)																						
PROBE TYPES																							
P01, P02, P03, P11, P12																							
<p>* 0" Available with extended process coupler or purge options</p>																							

Base Model for MT5000, MT5100 and MT5200 Transmitters

MT5000 Series Guide Wave Radar	MT5.	xxx	xxxx	xx	x	xx(x)
Device Type						
MT5000, Liquid Total Level Transmitter		000				
MT5100, Total Level and Interface Level Transmitter		100				
MT5200, Solids and Low Dielectric Liquid Total Level Transmitter		200				
Coupler Material						
None			Y			
316/L Stainless Steel (Standard)		S6*				
304/L Stainless Steel (Rigid Probe only)		S4				
Hastelloy C-276		H1				
Hastelloy B3 (Rigid Probes only)		H3				
Monel		M4				
Titanium (Rigid Probes only)		T2				
Inconel 625		IN2				
Special		Z9				
Transmitter Configuration						
None			Y			
Local Transmitter (Standard)			L*			
Local Transmitter with Window Cover (Standard)			LW*			
Remote Mounted Electronics with Standard 5 ft Cable (Dielectric > 15)			R			
Remote Mounted Electronics with Window Cover and Standard 5 ft Cable (Dielectric > 15)			RW			
Special			Z9			
Transmitter Housing						
None					Y	
Dual Compartment Aluminum Housing (Standard)					A*	
Dual Compartment 316 Stainless Steel Housing					S	
Special					Z	
Process Connection / Waveguide Coupler						
None						Y
0.75 in. NPT Process Connection Coupler Single / Coaxial Probe Teflon Insulator						C1*
0.75 in. NPT Process Connection Coupler Single / Coaxial Probe Teflon Insulator High Pressure						C1H
1.50 in. NPT Process Connection Coupler Single / Coaxial Probe Teflon Insulator						C2*
1.50 in. NPT Process Connection Coupler Single / Coaxial Probe Teflon Insulator High Pressure						C2H
2.50 in. NPT Process Connection Coupler Single / Coaxial Probe Teflon Insulator						C3
1.50 in. NPT Process Connection HP/HT Coupler Single Probe/Coaxial Probe Borosilicate Glass Insulator						C8
1.0 in. NPT Process Connection HP/HT Coupler Single Probe/Coaxial Probe Alumina Ceramic Insulator						C9
Custom Coupler, consult factory						CZ

* - Standard

Base Model

MT5000 Series Guide Wave Radar ordering information continued

MT5.xxx.xxxx.xx.x.xxx.	x(xxx)xxx(xxxxxx)
Process Seal Type	
None	Y
Viton FKM A O-Ring Process Seal -15 °F (-26 °C) Min Temp to 400 °F (204 °C) Max Temp Standard	V*
Additional Hermetic Glass Feed-Through with Viton FKM A O-Ring Process Seal	SV ^{1*}
Kalrez 4079 O-Ring Process Seal -40 °F (-40 °C) Min Temp to 400 °F (204 °C) Max Temp	K*
Additional Hermetic Glass Feed-Through with Kalrez 4079 O-Ring Process Seal	SK ^{1*}
EPDM O-Ring Process Seal -60 °F (-50 °C) Min Temp to 250 °F (125 °C) Max Temp	E
Additional Hermetic Glass Feed-Through with EPDM O-Ring Process Seal	SE ^{1*}
Markez Z1319 O-Ring Process Seal -14 °F (-10 °C) Min Temp to 572 °F (300 °C) Max Temp	A*
Additional Hermetic Glass Feed-Through with Markez Z1319 O-Ring Process Seal	SA ^{1*}
Borosilicate process seal, C8 coupler only	B*
Additional Hermetic Glass Feed-Through with Borosilicate Process Seal, C8 coupler only	SB ^{1*}
Special Process Seal	Z9
Probe Type	
None	Y
Rod probes	
Single Rigid Rod Probe, 0.25 in. (6 mm) Outer Diameter, 20 ft (6.1 m) Max Standard Length	P01*
Single Rigid Rod Probe, 0.50 in. (13 mm) Outer Diameter, 20 ft (6.10 m) Max Standard Length	P02*
Single Rigid Rod Probe 0.375 in. (9 mm) Outer Diameter, 20 ft (6.1 m) Max Standard Length	P03*
Simi-Rigid Rod Probe 0.125 in. (3 mm) Outer Diameter 50 ft (15.24 m) Max Standard Length Includes Weight	P43
Cable probes	
Single Flexible Cable Probe 0.1875 in. (5 mm) Outer Diameter, 200 ft (61 m) Max Standard Length	P11*
Single Flexible Cable Probe 0.25 in. (6 mm) Outer Diameter, 200 ft (61 m) Max Standard Length	P12*
Triangle Cable Probe 0.25 in. (6 mm) Outer Diameter, 100 ft (30.5 m) Max Standard Length	P33
Single Flexible Cable Probe 0.31 in (8 mm) Outer Diameter, 200 ft (61 m) Max Standard Length	P61
Coaxial probes	
Coaxial Probe 0.875 in. (22 mm) Outer Diameter 22 ft (6.7.5 m) Max Standard Length	P51
Coaxial Probe 1.315 in. (34 mm) Outer Diameter 316SS only 22 ft (6.7.5 m) Max Standard Length	P71
Coaxial Probe 0.1875 in. (5 mm) Outer Diameter 316SS only 22 ft (6.7.5 m) Max Standard Length	P81
Coaxial Probe 1.00 in. (25 mm) Outer Diameter 22 ft (6.7.5m) Max Standard Length with compression fitting	P91 ²
Custom Probe, consult factory	PZZ

1. Hermetic seal required for E1 and E2 approvals
 2. Maximum process pressure of 3.45 barg (50 psig)
 * - Standard

Base Model

MT5000 Series Guide Wave Radar ordering information continued

MT5.xxx.xxxx.xx.x.xx(x).x(xxx).	xxxx	xxxx	xx
Probe end attachment			
None	Y		
Centering weights (cable probes only)			
0.875 in. (22.2 mm) O.D., 4.0 in. (101.6 mm) Weight Height, approx. 0.7 lbs (301 g)	W09*		
1.0 in. (25.4mm) O.D., 6.0 in. (152.4 mm) Weight Height, approx. 1.3 lbs (590 g)	W10*		
1.25 in. (31.75 mm) O.D., 3.5 in. (88.9 mm) Weight Height, approx. 0.8 lbs (317 g)	W13*		
1.625 in. (41.3mm) O.D., 2.0 in. (50.8 mm) Weight Height, approx. 1.1 lbs (499 g)	W16		
1.875 in. (47.6 mm) O.D., 2.0 in. (50.8 mm) Weight Height, approx. 1.5 lbs (680 g)	W19		
2.875 in. (73.3 mm) O.D., 1.0 in. (25.4 mm) Weight Height, approx. 1.8 lbs (816 g)	W29		
2.00 in. (50.8 mm) O.D., 6.0 in. (152.4 mm) Weight Height, approx. 2.2 lbs (998 g)	WS6		
1.5 in. (38.1 mm) O.D., 5.25 in. (133.35 mm) Weight Height, approx. 2.2 lbs (998 g)	W61		
Custom Centering Weight (consult factory)	W99		
Centering disks (rod probes only)			
1.50 in. (38.1 mm) O.D. approx 0.4375 in. (11 mm) Height 1.50 in. (38.1 mm) Min Stilling Well Size	D15		
2.0 in. (50.8 mm) O.D. approx 0.4375 in. (11 mm) Height 2.0 in. (50.8 mm) Min Stilling Well Size	D20		
2.3 in. (58.7 mm) O.D. approx 0.4375 in. (11 mm) Height 2.5 in. (63.5 mm) Min Stilling Well Size	D23		
2.8 in. (71.1 mm) O.D. approx 0.4375 in. (11 mm) Height 3.0 in. (76.2 mm) Min Stilling Well Size	D28		
3.75 in. (95.3 mm) O.D. approx 0.4375 in. (11 mm) Height 4.0 in. (101.6 mm) Min Stilling Well Size	D38		
3.75 in. (95.3 mm) O.D. approx 0.4375 in. (11 mm) Height 4.0 in. (101.6 mm) Min Stilling Well Size	D60		
Custom Centering Disk (consult factory)	D99		
Eyelets (cable probes only)			
Eyelet SS6 for 0.1875 in. (5 mm) O.D. Cable	E1		
Eyelet SS6 for 0.25 in. (6 mm) O.D. Cable	E2		
Special	Z9		
Probe Attachment Material			
None		Y	
316/L Stainless Steel, Standard		S6*	
304/L Stainless Steel		S4	
Hastelloy C-276		H1	
Monel		M4	
Inconel 600		N2	
Special		Z9	
Process Temperature Extension			
Process Temperature 32 °F (0 °C) to 250 °F (121 °C) Standard			H0
Temperature Extension, extends electronics additional 6 in. above process connection			H6
Special			Z9

Base Model

MT5000 Series Guide Wave Radar ordering information continued

MT5.xxx.xxxx.xx.x.xx(x).x(xxx).xxxx.xxxx.xx.xxxx.	x(xxxx)	xxx	xxxx	xxx
Electronics Module				
None	Y			
Total Level, Graphic Display, 4 ... 20 mA Output, HART	M7A			
Total Level, Graphic Display, FOUNDATION fieldbus	M7AF			
Total and/or Interface Level, Graphic Display, 4 ... 20 mA Output, HART	M7B			
Total and/or Interface Level, Graphic Display, FOUNDATION fieldbus	M7BF			
Special	Z9			
Agency Approvals				
General purpose		Y0		
IECEX Intrinsically safe		E1		
IECEX Flameproof		E2		
FM / CSA Intrinsically safe		N1		
FM / CSA Explosion proof Housing		N2		
Special		Z9		
Process Connection Type				
None			Y0	
Integral Thread, Standard Process Connection			P4*	
Welded Process Connection			P2	
Loose flange for use with NPT threads. Specify flange type, material, and rating			P3	
Special			Z9	
Process Connection Material				
None				Y
304/L Stainless Steel				S4
316/L Stainless Steel				S6*
Carbon Steel				C1
Hastelloy C-276				H1
Alloy 20				A2
Monel 400				M4
Super Duplex Stainless Steel				D2
Special				Z9

Base Model

MT5000 Series Guide Wave Radar ordering information continued

MT5.xxx.xxxx.xx.x.xx(x).x(xxx).xxxx.xxxx.xx.xxxx.	xxxx
Flange or Plug Size // Rating / Type	
None	Y
3/4" MNPT Threaded (C1, C1H process couplers)	NTBN*
1.0" MNPT Threaded (C9 process coupler)	NTCN*
1.5" MNPT Threaded (C2, C2H and C8 process couplers)	NTEN*
2.5" MNPT Threaded (C3 process coupler)	NTGN
3/4" G thread, British Pipe Thread (BSPP), (C1, C1H process couplers)	GTBN
1.0" G thread, British Pipe Thread (BSPP), (C9 process coupler)	GTCN
1.5" G thread, British Pipe Thread (BSPP), (C2, C2H and C8 process couplers)	GTEN
2.5" G thread, British Pipe Thread (BSPP), (C3 process coupler)	GTGN
1 in. // ANSI / ASME Class 150 // Raised Face Flange	R11
1 in. // ANSI / ASME Class 300 // Raised Face Flange	R13
1 in. // ANSI / ASME Class 600 // Raised Face Flange	R16
1.5 in. // ANSI / ASME Class 150 // Raised Face Flange	R151
1.5 in. // ANSI / ASME Class 300 // Raised Face Flange	R153
1.5 in. // ANSI / ASME Class 600 // Raised Face Flange	R156
2 in. // ANSI / ASME Class 150 // Raised Face Flange	R21
2 in. // ANSI / ASME Class 300 // Raised Face Flange	R23
2 in. // ANSI / ASME Class 600 // Raised Face Flange	R26
2.5 in. // ANSI / ASME Class 150 // Raised Face Flange	R251
2.5 in. // ANSI / ASME Class 300 // Raised Face Flange	R253
2.5 in. // ANSI / ASME Class 600 // Raised Face Flange	R256
3 in. // ANSI / ASME Class 150 // Raised Face Flange	R31
3 in. // ANSI / ASME Class 300 // Raised Face Flange	R33
3 in. // ANSI / ASME Class 600 // Raised Face Flange	R36
4 in. // ANSI / ASME Class 150 // Raised Face Flange	R41
4 in. // ANSI / ASME Class 300 // Raised Face Flange	R43
4 in. // ANSI / ASME Class 600 // Raised Face Flange	R46
6 in. // ANSI / ASME Class 150 // Raised Face Flange	R61
6 in. // ANSI / ASME Class 300 // Raised Face Flange	R63
6 in. // ANSI / ASME Class 600 // Raised Face Flange	R66
DN 25 // PN 25 // Raised Face Flange	D2525
DN 25 // PN 40 // Raised Face Flange	D2540
DN 32 // PN 25 // Raised Face Flange	D3225

Note: DIN flanges are per EN1092-1

Base Model

MT5000 Series Guide Wave Radar ordering information continued

MT5.xxx.xxxx.xx.x.xx(x).x(xxx).xxxx.xxxx.xx.xxxx.	xxxx
Flange or Plug Size // Rating / Type - Continued from previous page	
DN 32 // PN 40 // Raised Face Flange	D3240
DN 40 // PN 25 // Raised Face Flange	D4025
DN 40 // PN 40 // Raised Face Flange	D4040
DN 50 // PN 25 // Raised Face Flange	D5025
DN 50 // PN 40 // Raised Face Flange	D5040
DN 65 // PN 25 // Raised Face Flange	D6525
DN 65 // PN 40 // Raised Face Flange	D6540
DN 80 // PN 25 // Raised Face Flange	D8025
DN 80 // PN 40 // Raised Face Flange	D8040
DN 100 // PN 25 // Raised Face Flange	D10025
DN 100 // PN 40 // Raised Face Flange	D10040
DN 125 // PN 25 // Raised Face Flange	D12525
DN 125 // PN 40 // Raised Face Flange	D12540
DN 150 // PN 25 // Raised Face Flange	D15025
DN 150 // PN 40 // Raised Face Flange	D15040
1.0 in. // ANSI / ASME Class 3000 // NPT-m Hex Plug	P1
1.5 in. // ANSI / ASME Class 3000 // NPT-m Hex Plug	P15
2.0 in. // ANSI / ASME Class 3000 // NPT-m Hex Plug	P2
2.5 in. // ANSI / ASME Class 3000 // NPT-m Hex Plug	P25
3.0 in. // ANSI / ASME Class 3000 // NPT-m Hex Plug	P3
Any flange not listed above, consult factory	Z9

Note: DIN flanges are per EN1092-1

Option codes are on the following page.

Option codes follow the model code with a dash (-)

MT5000 Series guided wave radar transmitter additional option codes

Additional options	MT5.xxx.xx(x).x(xx)x.xx.xxx(xx).x(x).xx(x)-	xxx	xxx	xxx	xxxx	xx
Additional Approvals or Certifications						
Furnished with CRN data package (includes tagging, MTR and hydro tests)		CRN				
Nuclear use, device to be used in a nuclear facility (application must be reviewed by ABB)		P4				
Special		CLZ				
Sensor options						
Electro-polish finish on wetted metal surfaces (not possible with cable or coax probe designs)			SEL			
240 grit polish on wetted metal surfaces (not possible with cable or coax probe designs)			SEP			
Add Teflon sleeve on probe for slip resistance only, not for corrosion resistance			SEN			
Add 1/4" purge or flush port (requires extended process coupler)			SEB			
Extended process coupler, specify distance			SE1			
Segment probe into 10ft sections, specific rod and coax probe selections			SE3			
Degreased (oil and grease free) for oxygen or chlorine service			P1			
Sensor special			SEZ			
Target float options						
Add 316L target float, minimum fluid specific gravity 0.6				FT1		
Special target float per application requirements				FZ9		
Remote electronics signal cable length (For remote coupler only)						
1.5 m (approx. 5 ft)					SRW	
3 m (approx. 9.8 ft)					SRT	
5 m (approx. 16.4 ft)					SR1	
Custom coaxial remote length					SRZ	
Repeat Indicator (for two analog level outputs)						
RI100 remote indicator (HART only), requires additional 4-20 loop, same material as transmitter housing						AR

Option codes continue on the following page.

Option codes follow the model code with a dash (-)

MT5000 Series guided wave radar transmitter additional option codes								
Additional options	MT5.xxx.xx(x).x(xx)x.xx.xxx(xx).x(x).xx(x)-xxx.xxx.xxx.xxxx.xx.	xxx	xx	xxxx	xx	xxx	xx	xxx
Add rod extension rod to probe (material and diameter determined by coupler selection)								
152.4 mm (6.0 in)		AR1						
304.8 mm (12.0 in.)		AR2						
457.2 mm (18 in.)		AR3						
Special		AR9						
Mounted Accessories								
Centering spacers as specified separately on order			AS					
Centering disk for cable weight (cable probes only, disk material same as weight)								
1.50 in. (38.1 mm) O.D.; 1.50 in. (38.1 mm) Min Stilling Well Size						WD1		
2.0 in. (50.8 mm) O.D.; 2.0 in. (50.8 mm) Min Stilling Well Size						WD2		
2.3 in. (58.7 mm) O.D.; 2.5 in. (63.5 mm) Min Stilling Well Size						WD3		
2.8 in. (71.1 mm) O.D.; 3.0 in. (76.2 mm) Min Stilling Well Size						WD4		
3.75 in. (95.3 mm) O.D.; 4.0 in. (101.6 mm) Min Stilling Well Size						WD5		
4.0 in. (101.6 mm) O.D.; 5.0 in. (125 mm) Min Stilling Well Size						WD6		
Custom disk for cable weight (consult factory)						WDZ		
Device Identification Plate								
Add stainless steel hang tag with custom tag no.							T1	
Add stainless steel hang tag, custom markings 4 lines, 22 characters per line							TS	
Other tagging special							TZ	
Electrical Connector Type								
Fieldbus 7/8 in. (without mating plug)							U1	
Fieldbus M12 x 1 (without mating plug)							U2	
M20 stainless steel adaptor							U8	
M20 brass adaptor							U9	
Electrical Connector Special							UZ	
Surge Protector								
Surge / Transient protector								S1
Special Other								
Transmitter Special Option								STT
Tower length extension special length - meter insulation capability								TEZ
Special paint or treatment on housing								STH
Special paint or treatment on flange								STF

Additional requirements and order comments are continued on the following page.

All codes located behind the // are for additional requirements and order comments.

These codes will not be included on the device tag.

All codes located behind the // are for additional requirements and order comments.

These codes will not be included on the device tag.

MT5000 Series guided wave radar additional option codes

Additional requirements and order comments	MT5.....x- ...//	xx	xxx
Certificates			
Test report 2.2 acc. EN 10204		C1	
MTR 3.1, Material monitoring with inspection certificate 3.1 acc. EN 10204		C2	
MTR 3.2, Material monitoring with inspection certificate 3.2 acc. EN 10204		C3	
Declaration of compliance with the order 2.1 acc. EN 10204		C4	
Material monitoring NACE MR 0175, MR 0103 with inspection certificate 3.1 acc. EN 10204		CN	
Printed record of configured settings in transmitter		CG	
With hydrostatic test report		CH	
With PMI report on wetted metal materials		CJ	
Other certificates		CZ	
Drawings			
Drawings for approval required prior to construction			GD1
Drawings for record required			GD2
Certified as built drawings required			GD3
Other drawings			GDZ

Additional requirements and order comments are continued on the following page.

All codes located behind the // are for additional requirements and order comments.

These codes will not be included on the device tag.

MT5000 Series guided wave radar additional option codes

Additional Requirements and coder comments	MT5.....x- ...//xx.xx.xx.xxx.	xx	xx	xx	xx
Documentation Language (installation, operation and maintenance manual)					
German		M1			
Italian		M2			
Spanish		M3			
French		M4			
English		M5			
Russian		MB			
Others		MZ			
Calibration Type					
3-point calibration verification certificate, factory default 90, 50 and 10% of measurable zone, or customer specified points within measurable zone			R3		
5-point calibration verification certificate, factory default 90, 75, 50, 25 and 10% of measurable zone, or customer specified points within measurable zone			R5		
Custom Linearization or Strapping table entered (up to 20 pts).			RL		
Witnessed calibration with certificate			RW		
Special calibration			RZ		
Programming and Parameter Settings					
Custom parameter settings					N6
Software Special					
Specified software version					V1
Custom software version					VZ

Probe Length

Minimum 24 in.	in.
Minimum 609.6 mm	mm

Contact us

ABB Inc.

Measurement & Analytics

3400. Rue Pierre-Ardouin

Québec, Québec G1P 0B2 CANADA

Office Phone: +1 418.877.2944 ext. 2109

Direct Line : +1 581.628.2109

E-mail: Radars@ca.abb.com

www.abb.com/level

ABB

Measurement & Analytics

No. 5, Lane 369, Chuangye Road,

Kangqiao Town, Pudong District

Shanghai, 201319, P.R.

China

Tel: +86 10 64231407

Fax: +86 10 64371913

www.abb.com/level

Note

We reserve the right to make technical changes or modify the contents of this document without prior notice. With regard to purchase orders, the agreed particulars shall prevail. ABB does not accept any responsibility whatsoever for potential errors or possible lack of information in this document.

We reserve all rights in this document and in the subject matter and illustrations contained therein. Any reproduction, disclosure to third parties or utilization of its contents - in whole or in parts - is forbidden without prior written consent of ABB.

Copyright © 2020 ABB

All rights reserved